



LISTE DE PRIX OUTDOOR 2025

FLOS
Outdoor



LISTE DES PRIX 2025

Les prix sont valables à partir du 1er Février 2025 / Prices are valid starting from February 1st 2025

FLOS

Outdoor



La température de couleur 2200K est disponible sur demande pour la plupart des produits présentés dans ce catalogue. Veuillez nous consulter pour la disponibilité au cas où vous auriez besoin de plus d'informations pour votre projet d'éclairage.

The 2200K color temperature is available upon request for most of the products featured in this catalogue. Please consult us for availability in case you need more information for you lighting project.

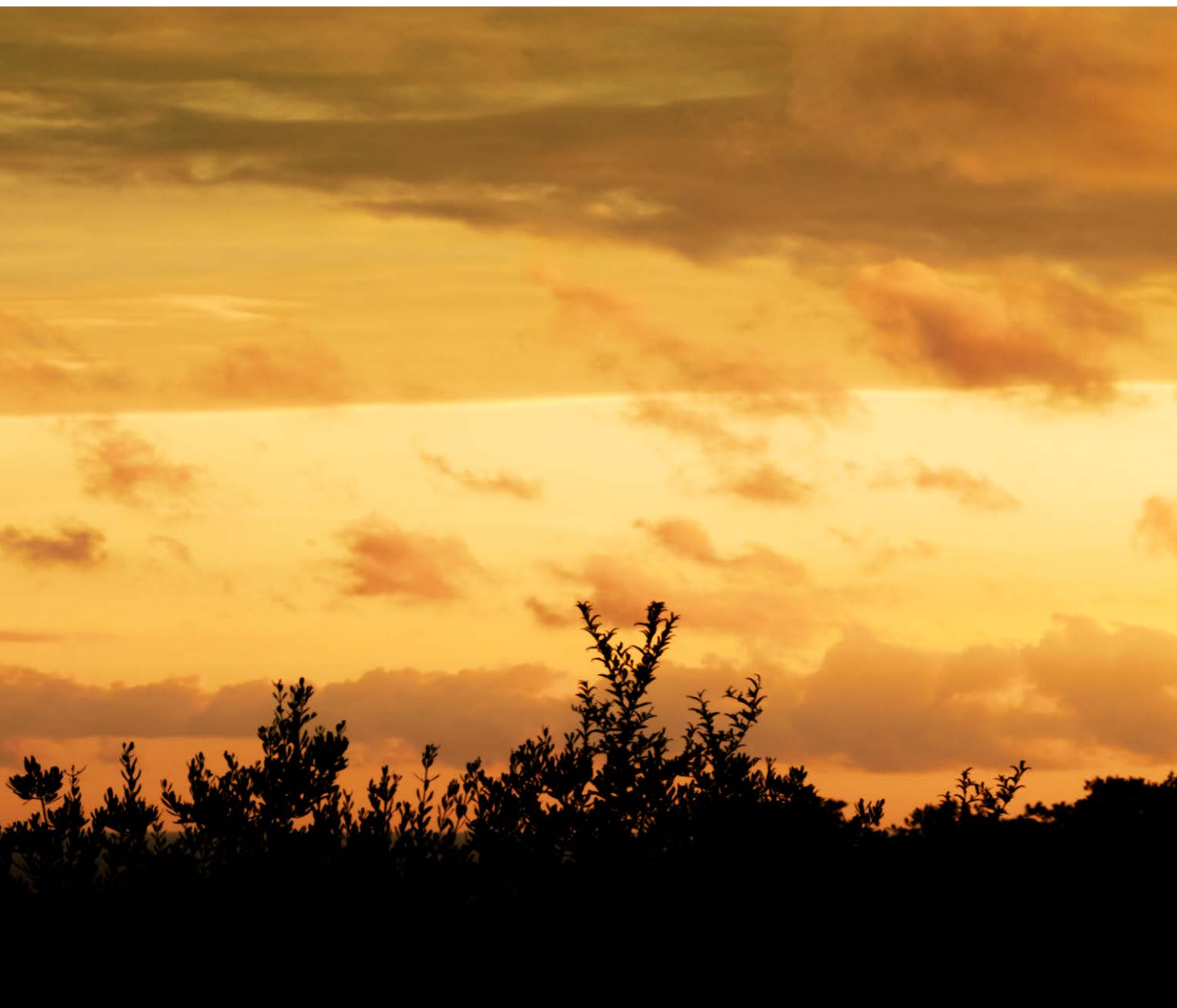

Inground

Landlord

292



A - Round

470



A - Rise

480



Gobi

504



C - Me

526



Linear

Ingraze

542

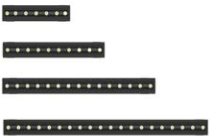

Outgraze

604



Tau

654



Spotlights

Spine

16



Landlord

292



Belvedere

348



Heavy Metal

440



Kirk

710



Spock

718



Aimer

730



Franco

764

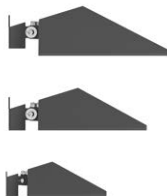

Perseo

786

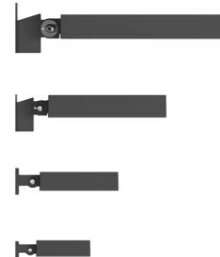

Table / Floor

In Vitro Unplugged

186



Mayday Outdoor

198



Captain Flint

240



IC Lights

250

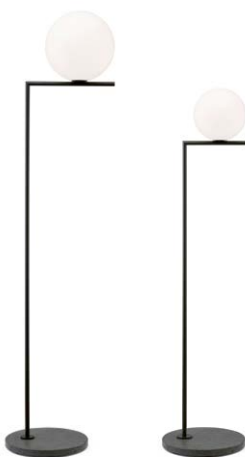

Caule

258

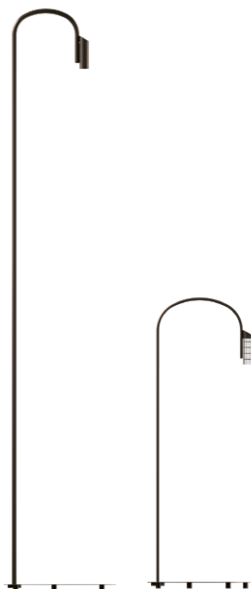

K - Tribe

285



Table / Floor

Superarchimoon

285



Bollard

Pointbreak

156



In Vitro

186

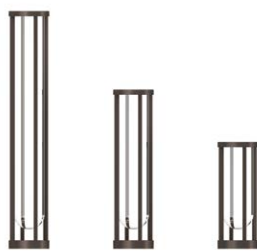

Mile

206



Caule

258

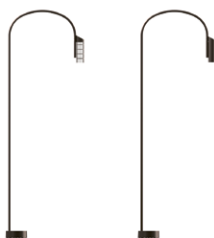

Landlord

292



Bellhop

310



Bollard

Casting

322

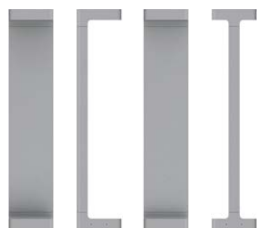

Casting Concrete

322



Walkstick

334



Klein Pro

360



Zefiro

370



I - Ron

380



Talia

388

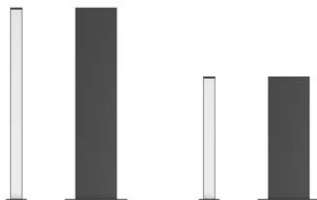

Aimer 2 Pole

730



Captain Flint Bollard

240

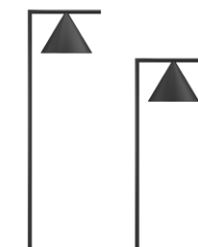

Wall

Pointbreak

156



In Vitro

186



Mile

206



Captain Flint

240



IC Lights

250



Flauta

274



Bellhop

310



Belvedere

348



Camouflage

416



Climber

426



Heavy Metal

440



Platter

686



Wall

Dooku

810



Graphic Light

Fenestra

462



Ceiling / Suspension

Pointbreak

156



In Vitro

186



Mile

206

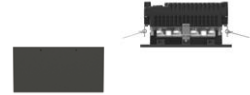

IC Lights

250



Romeo

285



Leila

698



Platter

686



Path

Mile

206



Wallstick

334



Real Matter

398



My Way

408



Gobi

504



Eclipse

666

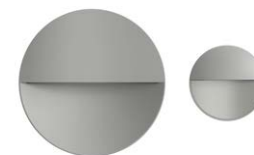

Hyperion

676



Pole / Pole Top

Bellhop

310



Franco

764



Perseo

786



Dooku

810



Spine

Designed by Vincent Van Duysen



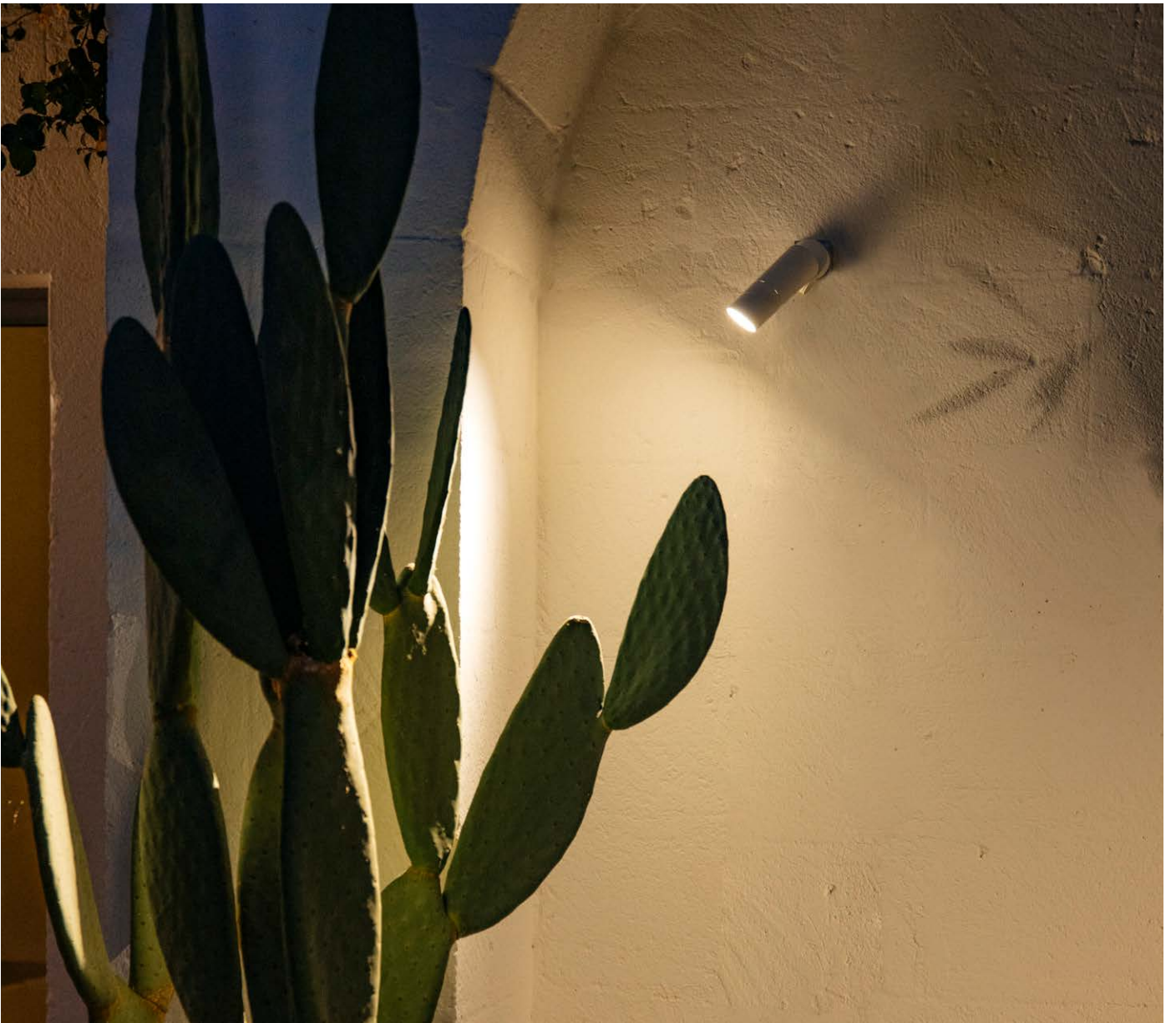





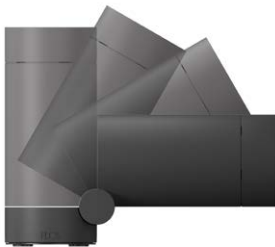

LIBERTÉ DE MOUVEMENT
Spine signifie colonne vertébrale, une image référencée dans l'articulation du corps d'éclairage, équipée d'une échelle graduée, qui peut être ajustée à la fois horizontalement et verticalement de 360° et 270° respectivement.

FREE TO MOVE
Spine means backbone, an image referenced in the joint of the lighting body, equipped with a graduated scale, which can be adjusted both horizontally and vertically by 360° and 270° respectively.



PRÊT POUR LE FUTUR
La tête supérieure a été conçue avec des cadres interchangeables pour personnaliser les performances du luminaire grâce à des accessoires optiques dédiés qui peuvent être combinés pour répondre aux exigences du projet.

FUTURE PROOF
The top head has been designed with interchangeable frames to customize the fixture's performance thanks to dedicated optic accessories that can be mixed to fulfill the project requirements.

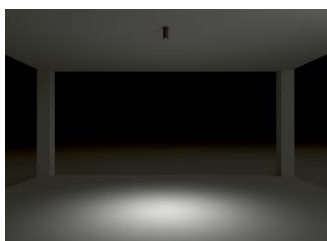

UN CONFORT VISUEL INCOMPARABLE
Une révolution dans l'éclairage d'accentuation extérieur. Le groupe optique a été conçu en pensant aux utilisateurs finaux, de sorte que la source reste cachée à la vue, en obtenant un confort visuel maximal sans sacrifier l'efficacité et les dimensions compactes.

UNCOMPARABLE VISUAL COMFORT
A revolution in outdoor accent lighting. The optical group has been designed with the end users in mind, so that the source remains hidden from view, achieving maximum visual comfort without sacrificing efficiency and compact dimensions.



CONNEXIONS CACHÉES À LA VUE
Le driver est intégré dans le corps du luminaire et toutes les connexions sont cachées dans la base.

CONNECTIONS HIDDEN FROM VIEW
The driver is integrated within the fixture's body making all connections hidden in the base.

Famille / Family

Spine 0 Pro



Power Led

up to 5W
up to 368 lm - 2700K/CRI 80
up to 377 lm - 3000K/CRI 80
up to 413 lm - 4000K/CRI 80
Net lumen output
2200K available on request.

Spine 0 Ultra



Power Led

up to 5W
up to 368 lm - 2700K/CRI 80
up to 377 lm - 3000K/CRI 80
up to 413 lm - 4000K/CRI 80
Net lumen output
2200K available on request.

Spine 1 Absolute



CoB Led

up to 11W
up to 923 lm - 2700K/CRI 80
up to 982 lm - 3000K/CRI 80
up to 1011 lm - 4000K/CRI 80
Net lumen output

Spine 1 Pro



Power Led

up to 3,5W
up to 143 lm - 2700K/CRI 80
up to 149 lm - 3000K/CRI 80
up to 154 lm - 4000K/CRI 80
Net lumen output
2200K available on request.

Power Led

up to 7,9W
up to 550 lm - 2700K/CRI 80
up to 571 lm - 3000K/CRI 80
up to 591 lm - 4000K/CRI 80
Net lumen output
2200K available on request.

Power Led HP

HP up to 10,5W
HP up to 680 lm - 2700K/CRI 80
HP up to 706 lm - 3000K/CRI 80
HP up to 730 lm - 4000K/CRI 80
Net lumen output

Spine 1 Ultra



Power Led

up to 3,5W
up to 143 lm - 2700K/CRI 80
up to 149 lm - 3000K/CRI 80
up to 154 lm - 4000K/CRI 80
Net lumen output
2200K available on request.

Power Led

up to 7,9W
up to 550 lm - 2700K/CRI 80
up to 571 lm - 3000K/CRI 80
up to 591 lm - 4000K/CRI 80
Net lumen output
2200K available on request.

Power Led HP

HP up to 10,5W
HP up to 680 lm - 2700K/CRI 80
HP up to 706 lm - 3000K/CRI 80
HP up to 730 lm - 4000K/CRI 80
Net lumen output

Spine 2 Absolute



CoB Led

up to 19,5W
up to 1939 lm - 2700K/CRI 80
up to 2085 lm - 3000K/CRI 80
up to 2120 lm - 4000K/CRI 80
Net lumen output

Spine 2 Pro



Power Led

up to 4,1W
up to 230 lm - 2700K/CRI 80
up to 239 lm - 3000K/CRI 80
up to 247 lm - 4000K/CRI 80
Net lumen output
2200K available on request.

Power Led

up to 10,5W
up to 769 lm - 2700K/CRI 80
up to 808 lm - 3000K/CRI 80
up to 846 lm - 4000K/CRI 80
Net lumen output

Power Led HP

HP up to 17W
HP up to 1443 lm - 2700K/CRI 80
HP up to 1497 lm - 3000K/CRI 80
HP up to 1548 lm - 4000K/CRI 80
Net lumen output
2200K available on request.

Spine 2 Ultra



Power Led

up to 4,1W
up to 230 lm - 2700K/CRI 80
up to 239 lm - 3000K/CRI 80
up to 247 lm - 4000K/CRI 80
Net lumen output
2200K available on request.

Power Led

up to 10,5W
up to 769 lm - 2700K/CRI 80
up to 808 lm - 3000K/CRI 80
up to 846 lm - 4000K/CRI 80
Net lumen output

Power Led HP

HP up to 17W
HP up to 1443 lm - 2700K/CRI 80
HP up to 1497 lm - 3000K/CRI 80
HP up to 1548 lm - 4000K/CRI 80
Net lumen output
2200K available on request.

Finitions / Colours



01 White



06 Grey

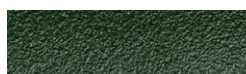

12 Forest Green



18 Deep Brown



30 Black



33 Anthracite

Équipés avec des sources LED de dernière génération, ils sont complétés par différentes solutions optiques haut de gamme.

La famille est composée de trois modèles : ABSOLUTE, PRO et ULTRA. Chaque projecteur est disponible en deux dimensions et deux puissances qui garantissent une polyvalence absolue et qui répondent ainsi parfaitement à toutes les exigences, que ce soit pour l'éclairage d'accentuation avec des faisceaux lumineux extrafins ou pour des surfaces plus amples. Spine est prêt à être installé au plafond, au mur ou au sol, avec borne à commander séparément.

Structure et dissipateur de chaleur en aluminium usiné par tournage (alliage EN AW 6060). Disponible en différentes finitions avec un revêtement à poudre double couche et une surface traitée par procédé de conversion chimique pour garantir une haute résistance à la corrosion. Diffuseur en verre trempé extra-clair avec un bord sérigraphié, fixé par un système d'encollage robotisé.

La version ABSOLUTE est équipée avec des LED COB à haut rendement et des réflecteurs en polymère, recouverts d'aluminium pur pour deux largeurs de faisceau.

Les versions PRO et ULTRA sont équipées avec des LED SMD de dernière génération. Le groupe optique est intégré sur la partie postérieure, garantissant ainsi un confort visuel absolu grâce à l'utilisation de lentilles personnalisées et à des prestations lumineuses élevées. La possibilité d'insérer dans le compartiment optique des collimateurs conçus pour modifier la largeur du faisceau — des faisceaux symétriques ponctuels, moyens et larges, à des faisceaux asymétriques et elliptiques— garantit une flexibilité totale pour répondre à toute sorte d'exigence lumineuse.

Pour un contrôle total du faisceau lumineux, les versions ULTR disposent d'un snoot intégré fourni et elles permettent d'insérer de nombreux accessoires comme des grilles honeycomb et des viseurs.

L'ajustement précis de l'unité d'émission est garanti par une articulation avec une échelle de référence graduée imprimée, qui assure une orientation de 270° sur l'axe vertical. La plaque de maintien en technopolymère de haute résistance mécanique permet une orientation de 360° sur l'axe horizontal pour pouvoir ajuster le faisceau lumineux en fonction des besoins. Les connexions électriques ont lieu à la base à travers un connecteur étanche inclus. La version comprend une borne en tant qu'accessoire, équipée d'un câble en néoprène pour une connexion électrique à distance.

La famille est complétée par une série d'accessoires pour des installations sur des surfaces solides ainsi que des équerres.

Family of outdoor, professional and adjustable projectors designed by Vincent Van Duysen. The product is characterized by a minimalist and elegant design suitable for the most varied contexts, from residential to hotel environments.

Equipped with state-of-the-art LED sources, they are completed by several upmarket optical solutions.

The family consists of three models: ABSOLUTE, PRO and ULTRA. Each model is available in two sizes and powers, which guarantee the maximum versatility and respond appropriately to any requirement: from accent lighting with extra-thin light beams to lighting for wider surfaces. Spine is ready for ground, wall or ceiling installation, and a pole can be ordered separately.

Turned aluminum body and heat sink (EN AW 6060 alloy). Available in different finishes with a double layer coating and a chemical conversion surface treatment to guarantee high resistance to corrosion. Extra clear tempered glass diffuser with silkscreen border, fixed through a robotic gluing system. The ABSOLUTE version is equipped with a high-performance LED COB light source and polymer reflectors, covered in pure aluminum for two beam angles.

The PRO and ULTRA versions are equipped with a state-of-the-art LED SMD. The optical unit is integrated in the rear part, which guarantees an absolute visual comfort thanks to the use of customized lenses, as well as high lighting performances. The possibility of inserting collimators in the optical compartment that are designed to modify the beam angle—from punctual, medium and large symmetric beams to asymmetric and elliptical beams—guarantee an extreme flexibility to meet any lighting requirement.

To fully control the light beam, the ULTRA versions are equipped with an integrated supplied snoot and allow the insertion of numerous accessories such as the honeycomb and visor. The exact dimming of the emitting unit is guaranteed by the joint with a graduated reference scale printed on it, which ensures an orientation of 270° on the vertical axis. The high mechanical resistance technopolymer fixing plate allows 360° orientation on the horizontal axis, thus allowing the light beam to be directed according to individual requirements.

The electrical connections are made on the base by means of a watertight connector included. Version including a bollard as an accessory, equipped with a neoprene cable for remote electrical connection.

The family is completed by a series of accessories for solid surface and mast installation.



MOUNTING OPTIONS

Spine

Ø70 / Ø90

Absolute / Pro / Ultra

Ø50

Pro / Ultra



+

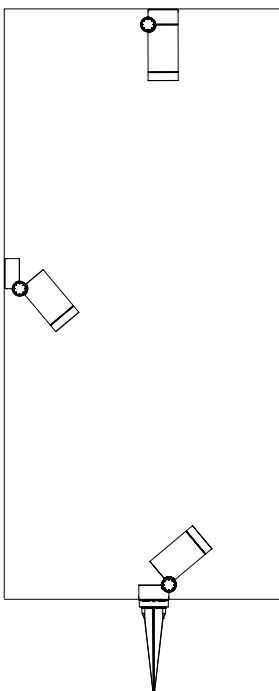

Spine F

Ø70 / Ø90

Absolute / Pro / Ultra

Ø50

Pro / Ultra



Câble en néoprène de 5m (10m sur commande) pour connexion à distance.

5m neoprene cable (10m on request) for remote connection.

+

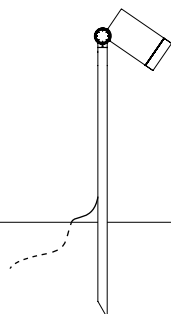
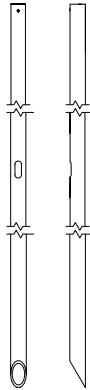

Spine L

Ø70 / Ø90

Absolute / Pro / Ultra



Câble en néoprène de 5m (10m sur commande) pour connexion à distance.

5m neoprene cable (10m on request) for remote connection.

+

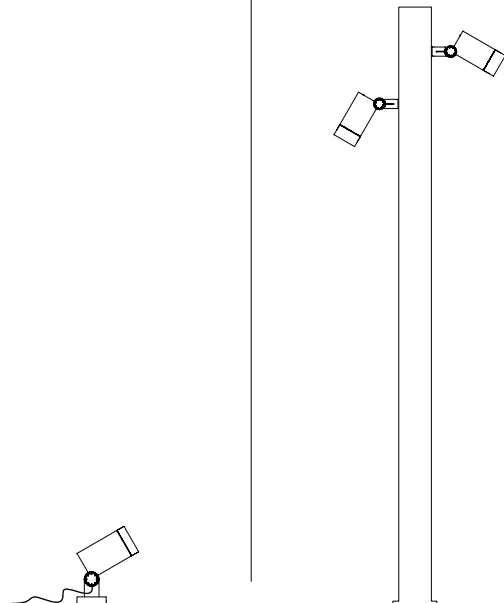
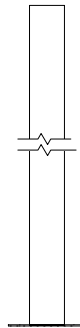

Spine T

Ø70 / Ø90

Absolute / Pro / Ultra

Ø50

Pro / Ultra



Câble en néoprène de 5m (10m sur commande) pour connexion à distance.

5m neoprene cable (10m on request) for remote connection.



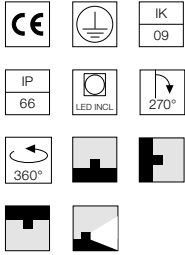
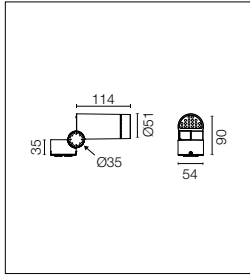

Source Power LED incluse. Équipée d'un snoot intégré pour un plus grand confort visuel. Les collimateurs sont des accessoires disponibles pour modifier la largeur du faisceau lumineux. Source d'alimentation électrique intégrée 220-240V ON/OFF. Plaque d'ancrage incluse. La connexion électrique a lieu à l'intérieur de la plaque par un connecteur étanche inclus. Pour garantir l'étanchéité, il est conseillé d'utiliser des câbles flexibles conçus pour l'extérieur. Clou métallique pour l'installation au sol, à commander séparément.

Power LED source included. Equipped with an integrated snoot for higher visual comfort. Collimators are available as an accessory to modify the beam opening. Integrated electric power supply 220-240V ON/OFF. Fixing plate included. The electrical connection is made on the inside of the plate by means of a watertight connector included. To guarantee its water tightness, it is recommended to use flexible cables designed for outdoor use. Ground spike for ground installations to be ordered separately.

2200K disponible sur demande.

2200K available on request.

Version dimmable DALI disponible sur demande.

DALI dimmable version available on request.

Optic Spot 14°

Power Led: 5W - 481 lm ≠ FIXT 368 lm - 2700K/CRI 80 - 220-240V / 5W - 493 lm ≠ FIXT 377 lm - 3000K/CRI 80 - 220-240V / 5W - 540 lm ≠ FIXT 413 lm - 4000K/CRI 80 - 220-240V

2700K

Non Dimmable

○ F027D2BA001	311,00 €
● F027D2BA006	311,00 €
● F027D2BA012	311,00 €
● F027D2BA018	311,00 €
● F027D2BA030	311,00 €
● F027D2BA033	311,00 €

3000K

Non Dimmable

○ F027D3BA001	311,00 €
● F027D3BA006	311,00 €
● F027D3BA012	311,00 €
● F027D3BA018	311,00 €
● F027D3BA030	311,00 €
● F027D3BA033	311,00 €

4000K

Non Dimmable

○ F027D4BA001	311,00 €
● F027D4BA006	311,00 €
● F027D4BA012	311,00 €
● F027D4BA018	311,00 €
● F027D4BA030	311,00 €
● F027D4BA033	311,00 €

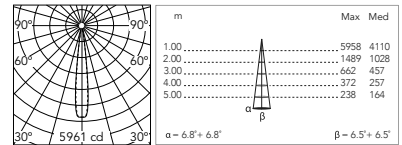

@ 3000K

Optic Medium Flood 26°

Power Led: 5W - 481 lm ≠ FIXT 337 lm - 2700K/CRI 80 - 220-240V / 5W - 493 lm ≠ FIXT 346 lm - 3000K/CRI 80 - 220-240V / 5W - 540 lm ≠ FIXT 378 lm - 4000K/CRI 80 - 220-240V

2700K

Non Dimmable

○ F027D2CA001	311,00 €
● F027D2CA006	311,00 €
● F027D2CA012	311,00 €
● F027D2CA018	311,00 €
● F027D2CA030	311,00 €
● F027D2CA033	311,00 €

3000K

Non Dimmable

○ F027D3CA001	311,00 €
● F027D3CA006	311,00 €
● F027D3CA012	311,00 €
● F027D3CA018	311,00 €
● F027D3CA030	311,00 €
● F027D3CA033	311,00 €

4000K

Non Dimmable

○ F027D4CA001	311,00 €
● F027D4CA006	311,00 €
● F027D4CA012	311,00 €
● F027D4CA018	311,00 €
● F027D4CA030	311,00 €
● F027D4CA033	311,00 €

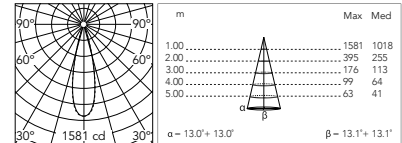

@ 3000K

Optic Flood 36°

Power Led: 5W - 481 lm ≠ FIXT 332 lm - 2700K/CRI 80 - 220-240V / 5W - 493 lm ≠ FIXT 340 lm - 3000K/CRI 80 - 220-240V / 5W - 540 lm ≠ FIXT 373 lm - 4000K/CRI 80 - 220-240V

2700K

Non Dimmable

○ F027D2DA001	311,00 €
● F027D2DA006	311,00 €
● F027D2DA012	311,00 €
● F027D2DA018	311,00 €
● F027D2DA030	311,00 €
● F027D2DA033	311,00 €

3000K

Non Dimmable

○ F027D3DA001	311,00 €
● F027D3DA006	311,00 €
● F027D3DA012	311,00 €
● F027D3DA018	311,00 €
● F027D3DA030	311,00 €
● F027D3DA033	311,00 €

4000K

Non Dimmable

○ F027D4DA001	311,00 €
● F027D4DA006	311,00 €
● F027D4DA012	311,00 €
● F027D4DA018	311,00 €
● F027D4DA030	311,00 €
● F027D4DA033	311,00 €

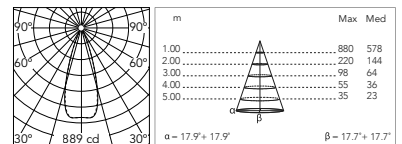

@ 3000K

Optic Wide Flood 50°

Power Led: 5W - 481 lm ≠ FIXT 324 lm - 2700K/CRI 80 - 220-240V / 5W - 493 lm ≠ FIXT 332 lm - 3000K/CRI 80 - 220-240V / 5W - 540 lm ≠ FIXT 363 lm - 4000K/CRI 80 - 220-240V

2700K

Non Dimmable

○ F027D2EA001	311,00 €
● F027D2EA006	311,00 €
● F027D2EA012	311,00 €
● F027D2EA018	311,00 €
● F027D2EA030	311,00 €
● F027D2EA033	311,00 €

3000K

Non Dimmable

○ F027D3EA001	311,00 €
● F027D3EA006	311,00 €
● F027D3EA012	311,00 €
● F027D3EA018	311,00 €
● F027D3EA030	311,00 €
● F027D3EA033	311,00 €

4000K

Non Dimmable

○ F027D4EA001	311,00 €
● F027D4EA006	311,00 €
● F027D4EA012	311,00 €
● F027D4EA018	311,00 €
● F027D4EA030	311,00 €
● F027D4EA033	311,00 €

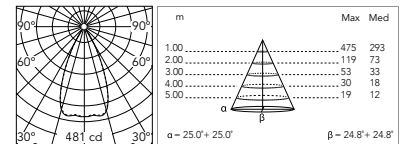

@ 3000K

Spine 0 Pro

Optic Elliptical 1 12° x 50°

Power Led: 5W - 481 lm ≠ FIXT 342 lm - 2700K/CRI 80 - 220-240V / 5W - 493 lm ≠ FIXT 350 lm - 3000K/CRI 80 - 220-240V / 5W - 540 lm ≠ FIXT 383 lm - 4000K/CRI 80 - 220-240V

2700K

Non Dimmable

○ F027D2FA001	311,00 €
● F027D2FA006	311,00 €
● F027D2FA012	311,00 €
● F027D2FA018	311,00 €
● F027D2FA030	311,00 €
● F027D2FA033	311,00 €

3000K

Non Dimmable

○ F027D3FA001	311,00 €
● F027D3FA006	311,00 €
● F027D3FA012	311,00 €
● F027D3FA018	311,00 €
● F027D3FA030	311,00 €
● F027D3FA033	311,00 €

4000K

Non Dimmable

○ F027D4FA001	311,00 €
● F027D4FA006	311,00 €
● F027D4FA012	311,00 €
● F027D4FA018	311,00 €
● F027D4FA030	311,00 €
● F027D4FA033	311,00 €

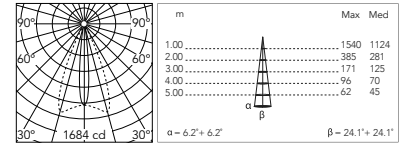

@ 3000K

Optic Elliptical 2 26° x 51°

Power Led: 5W - 481 lm ≠ FIXT 334 lm - 2700K/CRI 80 - 220-240V / 5W - 493 lm ≠ FIXT 342 lm - 3000K/CRI 80 - 220-240V / 5W - 540 lm ≠ FIXT 375 lm - 4000K/CRI 80 - 220-240V

2700K

Non Dimmable

○ F027D2GA001	311,00 €
● F027D2GA006	311,00 €
● F027D2GA012	311,00 €
● F027D2GA018	311,00 €
● F027D2GA030	311,00 €
● F027D2GA033	311,00 €

3000K

Non Dimmable

○ F027D3GA001	311,00 €
● F027D3GA006	311,00 €
● F027D3GA012	311,00 €
● F027D3GA018	311,00 €
● F027D3GA030	311,00 €
● F027D3GA033	311,00 €

4000K

Non Dimmable

○ F027D4GA001	311,00 €
● F027D4GA006	311,00 €
● F027D4GA012	311,00 €
● F027D4GA018	311,00 €
● F027D4GA030	311,00 €
● F027D4GA033	311,00 €

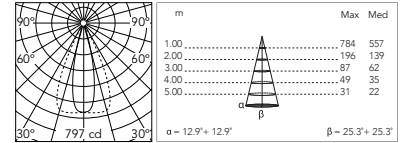

@ 3000K

Optic Wall Washer

Power Led: 5W - 481 lm ≠ FIXT 321 lm - 2700K/CRI 80 - 220-240V / 5W - 493 lm ≠ FIXT 329 lm - 3000K/CRI 80 - 220-240V / 5W - 540 lm ≠ FIXT 360 lm - 4000K/CRI 80 - 220-240V

2700K

Non Dimmable

○ F027D2HA001	311,00 €
● F027D2HA006	311,00 €
● F027D2HA012	311,00 €
● F027D2HA018	311,00 €
● F027D2HA030	311,00 €
● F027D2HA033	311,00 €

3000K

Non Dimmable

○ F027D3HA001	311,00 €
● F027D3HA006	311,00 €
● F027D3HA012	311,00 €
● F027D3HA018	311,00 €
● F027D3HA030	311,00 €
● F027D3HA033	311,00 €

4000K

Non Dimmable

○ F027D4HA001	311,00 €
● F027D4HA006	311,00 €
● F027D4HA012	311,00 €
● F027D4HA018	311,00 €
● F027D4HA030	311,00 €
● F027D4HA033	311,00 €

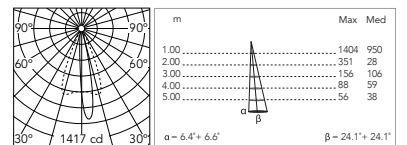

@ 3000K

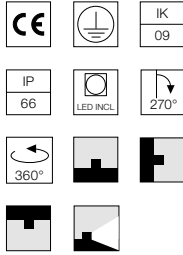
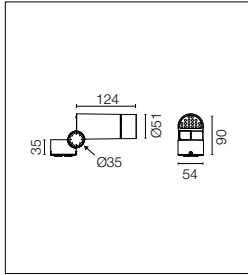

Source Power LED incluse. Équipée d'un snoot intégré pour un plus grand confort visuel. Les collimateurs sont des accessoires disponibles pour modifier la largeur du faisceau lumineux. Source d'alimentation électrique intégrée 220-240V ON/OFF. Plaque d'ancrage incluse. La connexion électrique a lieu à l'intérieur de la plaque par un connecteur étanche inclus. Pour garantir l'étanchéité, il est conseillé d'utiliser des câbles flexibles conçus pour l'extérieur. Clou métallique pour l'installation au sol, à commander séparément.

Power LED source included. Equipped with an integrated snoot for higher visual comfort. Collimators are available as an accessory to modify the beam opening. Integrated electric power supply 220-240V ON/OFF. Fixing plate included. The electrical connection is made on the inside of the plate by means of a watertight connector included. To guarantee its water tightness, it is recommended to use flexible cables designed for outdoor use. Ground spike for ground installations to be ordered separately.

2200K disponible sur demande.

2200K available on request.

Version dimmable DALI disponible sur demande.

DALI dimmable version available on request.

Optic Spot 14°

Power Led: 5W - 481 lm ≠ FIXT 368 lm - 2700K/CRI 80 - 220-240V / 5W - 493 lm ≠ FIXT 377 lm - 3000K/CRI 80 - 220-240V / 5W - 540 lm ≠ FIXT 413 lm - 4000K/CRI 80 - 220-240V

2700K

Non Dimmable

○ F027B2BA001	346,00 €
● F027B2BA006	346,00 €
● F027B2BA012	346,00 €
● F027B2BA018	346,00 €
● F027B2BA030	346,00 €
● F027B2BA033	346,00 €

3000K

Non Dimmable

○ F027B3BA001	346,00 €
● F027B3BA006	346,00 €
● F027B3BA012	346,00 €
● F027B3BA018	346,00 €
● F027B3BA030	346,00 €
● F027B3BA033	346,00 €

4000K

Non Dimmable

○ F027B4BA001	346,00 €
● F027B4BA006	346,00 €
● F027B4BA012	346,00 €
● F027B4BA018	346,00 €
● F027B4BA030	346,00 €
● F027B4BA033	346,00 €

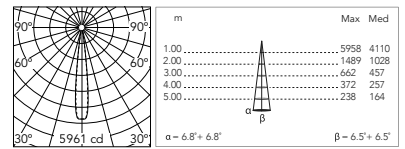

@ 3000K

Optic Medium Flood 26°

Power Led: 5W - 481 lm ≠ FIXT 337 lm - 2700K/CRI 80 - 220-240V / 5W - 493 lm ≠ FIXT 346 lm - 3000K/CRI 80 - 220-240V / 5W - 540 lm ≠ FIXT 378 lm - 4000K/CRI 80 - 220-240V

2700K

Non Dimmable

○ F027B2CA001	346,00 €
● F027B2CA006	346,00 €
● F027B2CA012	346,00 €
● F027B2CA018	346,00 €
● F027B2CA030	346,00 €
● F027B2CA033	346,00 €

3000K

Non Dimmable

○ F027B3CA001	346,00 €
● F027B3CA006	346,00 €
● F027B3CA012	346,00 €
● F027B3CA018	346,00 €
● F027B3CA030	346,00 €
● F027B3CA033	346,00 €

4000K

Non Dimmable

○ F027B4CA001	346,00 €
● F027B4CA006	346,00 €
● F027B4CA012	346,00 €
● F027B4CA018	346,00 €
● F027B4CA030	346,00 €
● F027B4CA033	346,00 €

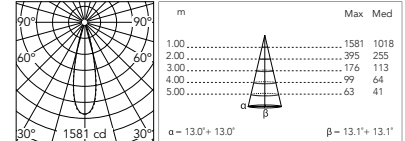

@ 3000K

Optic Flood 36°

Power Led: 5W - 481 lm ≠ FIXT 332 lm - 2700K/CRI 80 - 220-240V / 5W - 493 lm ≠ FIXT 340 lm - 3000K/CRI 80 - 220-240V / 5W - 540 lm ≠ FIXT 373 lm - 4000K/CRI 80 - 220-240V

2700K

Non Dimmable

○ F027B2DA001	346,00 €
● F027B2DA006	346,00 €
● F027B2DA012	346,00 €
● F027B2DA018	346,00 €
● F027B2DA030	346,00 €
● F027B2DA033	346,00 €

3000K

Non Dimmable

○ F027B3DA001	346,00 €
● F027B3DA006	346,00 €
● F027B3DA012	346,00 €
● F027B3DA018	346,00 €
● F027B3DA030	346,00 €
● F027B3DA033	346,00 €

4000K

Non Dimmable

○ F027B4DA001	346,00 €
● F027B4DA006	346,00 €
● F027B4DA012	346,00 €
● F027B4DA018	346,00 €
● F027B4DA030	346,00 €
● F027B4DA033	346,00 €

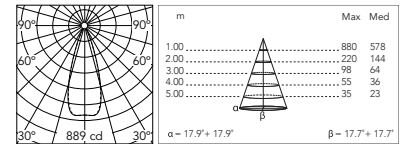

@ 3000K

Optic Wide Flood 50°

Power Led: 5W - 481 lm ≠ FIXT 324 lm - 2700K/CRI 80 - 220-240V / 5W - 493 lm ≠ FIXT 332 lm - 3000K/CRI 80 - 220-240V / 5W - 540 lm ≠ FIXT 363 lm - 4000K/CRI 80 - 220-240V

2700K

Non Dimmable

○ F027B2EA001	346,00 €
● F027B2EA006	346,00 €
● F027B2EA012	346,00 €
● F027B2EA018	346,00 €
● F027B2EA030	346,00 €
● F027B2EA033	346,00 €

3000K

Non Dimmable

○ F027B3EA001	346,00 €
● F027B3EA006	346,00 €
● F027B3EA012	346,00 €
● F027B3EA018	346,00 €
● F027B3EA030	346,00 €
● F027B3EA033	346,00 €

4000K

Non Dimmable

○ F027B4EA001	346,00 €
● F027B4EA006	346,00 €
● F027B4EA012	346,00 €
● F027B4EA018	346,00 €
● F027B4EA030	346,00 €
● F027B4EA033	346,00 €

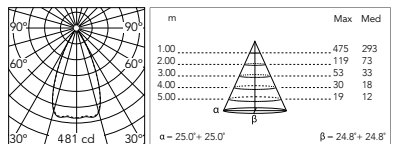

@ 3000K

Optic Elliptical 1 12° x 50°

Power Led: 5W - 481 lm ≠ FIXT 342 lm - 2700K/CRI 80 - 220-240V / 5W - 493 lm ≠ FIXT 350 lm - 3000K/CRI 80 - 220-240V / 5W - 540 lm ≠ FIXT 383 lm - 4000K/CRI 80 - 220-240V

2700K

Non Dimmable

○ F027B2FA001	346,00 €
● F027B2FA006	346,00 €
● F027B2FA012	346,00 €
● F027B2FA018	346,00 €
● F027B2FA030	346,00 €
● F027B2FA033	346,00 €

3000K

Non Dimmable

○ F027B3FA001	346,00 €
● F027B3FA006	346,00 €
● F027B3FA012	346,00 €
● F027B3FA018	346,00 €
● F027B3FA030	346,00 €
● F027B3FA033	346,00 €

4000K

Non Dimmable

○ F027B4FA001	346,00 €
● F027B4FA006	346,00 €
● F027B4FA012	346,00 €
● F027B4FA018	346,00 €
● F027B4FA030	346,00 €
● F027B4FA033	346,00 €

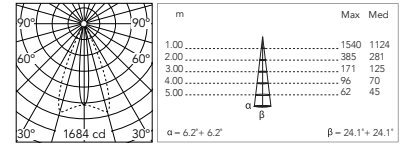

@ 3000K

Optic Elliptical 2 26° x 51°

Power Led: 5W - 481 lm ≠ FIXT 334 lm - 2700K/CRI 80 - 220-240V / 5W - 493 lm ≠ FIXT 342 lm - 3000K/CRI 80 - 220-240V / 5W - 540 lm ≠ FIXT 375 lm - 4000K/CRI 80 - 220-240V

2700K

Non Dimmable

○ F027B2GA001	346,00 €
● F027B2GA006	346,00 €
● F027B2GA012	346,00 €
● F027B2GA018	346,00 €
● F027B2GA030	346,00 €
● F027B2GA033	346,00 €

3000K

Non Dimmable

○ F027B3GA001	346,00 €
● F027B3GA006	346,00 €
● F027B3GA012	346,00 €
● F027B3GA018	346,00 €
● F027B3GA030	346,00 €
● F027B3GA033	346,00 €

4000K

Non Dimmable

○ F027B4GA001	346,00 €
● F027B4GA006	346,00 €
● F027B4GA012	346,00 €
● F027B4GA018	346,00 €
● F027B4GA030	346,00 €
● F027B4GA033	346,00 €

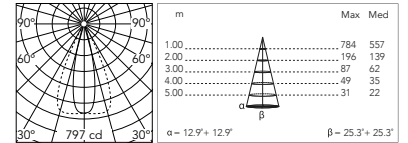

@ 3000K

Optic Wall Washer

Power Led: 5W - 481 lm ≠ FIXT 321 lm - 2700K/CRI 80 - 220-240V / 5W - 493 lm ≠ FIXT 329 lm - 3000K/CRI 80 - 220-240V / 5W - 540 lm ≠ FIXT 360 lm - 4000K/CRI 80 - 220-240V

2700K

Non Dimmable

○ F027B2HA001	346,00 €
● F027B2HA006	346,00 €
● F027B2HA012	346,00 €
● F027B2HA018	346,00 €
● F027B2HA030	346,00 €
● F027B2HA033	346,00 €

3000K

Non Dimmable

○ F027B3HA001	346,00 €
● F027B3HA006	346,00 €
● F027B3HA012	346,00 €
● F027B3HA018	346,00 €
● F027B3HA030	346,00 €
● F027B3HA033	346,00 €

4000K



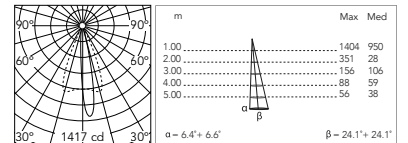

Non Dimmable

○ F027B4HA001	346,00 €
● F027B4HA006	346,00 €
● F027B4HA012	346,00 €
● F027B4HA018	346,00 €
● F027B4HA030	346,00 €
● F027B4HA033	346,00 €

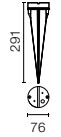

@ 3000K

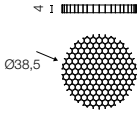
Spine 0 Pro: Accessoires / Accessories

Pique de terre.	Ground spike.	F027Z010000	27,00 €		
Honeycomb	Honeycomb Louvre	F027Z060000	17,00 €		
Lentilles de conversion / Converter lenses:					
- Converter Spine 0 / Spine 1 Optic Medium Flood		F029Z010000	35,00 €		
- Converter Spine 0 / Spine 1 Optic Flood		F029Z011000	35,00 €		
- Converter Spine 0 / Spine 1 Optic Wide Flood		F029Z012000	35,00 €		
- Converter Spine 0 / Spine 1 Optic Elliptic 1		F029Z013000	35,00 €		
- Converter Spine 0 / Spine 1 Optic Elliptic 2		F029Z014000	35,00 €		
- Converter Spine 0 / Spine 1 Optic Wall Washer		F029Z015000	35,00 €		

Spine 0 Ultra: Accessoires / Accessories

Viseur	Visor	<ul style="list-style-type: none"> ○ F027Z050001 47,00 € ● F027Z050006 47,00 € ● F027Z050012 47,00 € ● F027Z050018 47,00 € ● F027Z050030 47,00 € ● F027Z050033 47,00 € 		
Pique de terre.	Ground spike.	F027Z010000	27,00 €	
Honeycomb	Honeycomb Louvre	F027Z060000	17,00 €	
Lentilles de conversion / Converter lenses:				
- Converter Spine 0 / Spine 1 Optic Medium Flood		F029Z010000	35,00 €	
- Converter Spine 0 / Spine 1 Optic Flood		F029Z011000	35,00 €	
- Converter Spine 0 / Spine 1 Optic Wide Flood		F029Z012000	35,00 €	
- Converter Spine 0 / Spine 1 Optic Elliptic 1		F029Z013000	35,00 €	
- Converter Spine 0 / Spine 1 Optic Elliptic 2		F029Z014000	35,00 €	
- Converter Spine 0 / Spine 1 Optic Wall Washer		F029Z015000	35,00 €	

Spine 1 Absolute

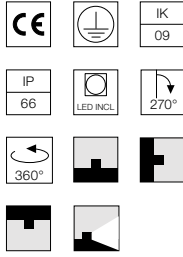
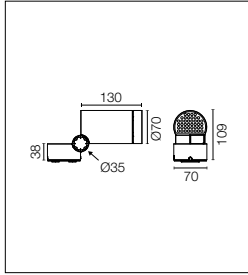

Source LED COB incluse. Source d'alimentation électrique intégrée 220-240V ON/OFF. Plaque d'ancrage incluse. La connexion électrique a lieu à l'intérieur de la plaque par un connecteur étanche inclus. Pour garantir l'étanchéité, il est conseillé d'utiliser des câbles flexibles conçus pour l'extérieur. Clou métallique pour l'installation au sol, à commander séparément. Sur commande, version réglable 1-10V ou DALI avec source d'alimentation à distance 24Vdc.

LED COB light source included. Integrated electric power supply 220-240V ON/OFF. Fixing plate included. The electrical connection is made on the inside of the plate by means of a watertight connector included. To guarantee its water tightness, it is recommended to use flexible cables designed for outdoor use. Ground spike for ground installations to be ordered separately. Upon request: 1-10V or DALI dimmable version with 24Vdc remote power supply.

Optic Spot 15°

CoB Led: 11W - 1247 lm ≠ FIXT 923 lm - 2700K/CRI 80 - 220-240V / 11W - 1325 lm ≠ FIXT 982 lm - 3000K/CRI 80 - 220-240V / 11W - 1364 lm ≠ FIXT 1011 lm - 4000K/CRI 80 - 220-240V

2700K

Non Dimmable

○ F025A2BA001	355,00 €
● F025A2BA006	355,00 €
● F025A2BA012	355,00 €
● F025A2BA018	355,00 €
● F025A2BA030	355,00 €
● F025A2BA033	355,00 €

3000K

Non Dimmable

○ F025A3BA001	355,00 €
● F025A3BA006	355,00 €
● F025A3BA012	355,00 €
● F025A3BA018	355,00 €
● F025A3BA030	355,00 €
● F025A3BA033	355,00 €

4000K

Non Dimmable

○ F025A4BA001	355,00 €
● F025A4BA006	355,00 €
● F025A4BA012	355,00 €
● F025A4BA018	355,00 €
● F025A4BA030	355,00 €
● F025A4BA033	355,00 €

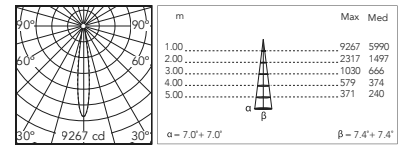

@ 3000K

Optic Medium Flood 33°

CoB Led: 11W - 1247 lm ≠ FIXT 906 lm - 2700K/CRI 80 - 220-240V / 11W - 1325 lm ≠ FIXT 964 lm - 3000K/CRI 80 - 220-240V / 11W - 1364 lm ≠ FIXT 993 lm - 4000K/CRI 80 - 220-240V

2700K

Non Dimmable

○ F025A2CA001	355,00 €
● F025A2CA006	355,00 €
● F025A2CA012	355,00 €
● F025A2CA018	355,00 €
● F025A2CA030	355,00 €
● F025A2CA033	355,00 €

3000K

Non Dimmable

○ F025A3CA001	355,00 €
● F025A3CA006	355,00 €
● F025A3CA012	355,00 €
● F025A3CA018	355,00 €
● F025A3CA030	355,00 €
● F025A3CA033	355,00 €

4000K

Non Dimmable

○ F025A4CA001	355,00 €
● F025A4CA006	355,00 €
● F025A4CA012	355,00 €
● F025A4CA018	355,00 €
● F025A4CA030	355,00 €
● F025A4CA033	355,00 €

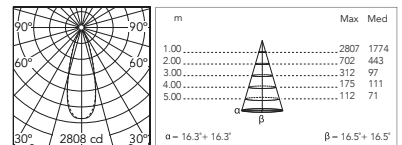

@ 3000K

Spine 1 Absolute: Accessoires / Accessories

Pique de terre. Ground spike. F026Z010000 27,00 €



Honeycomb Honeycomb Louvre F025Z060000 20,00 €

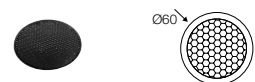

Spine 2 Absolute

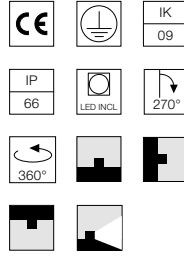
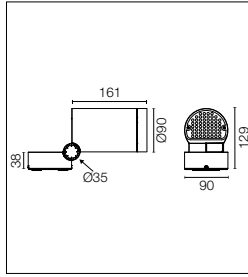

Source LED COB incluse. Source d'alimentation électrique intégrée 220-240V ON/OFF et réglable 1-10V ou DALI. Plaque d'ancrage incluse. La connexion électrique a lieu à l'intérieur de la plaque par un connecteur étanche inclus. Pour garantir l'étanchéité, il est conseillé d'utiliser des câbles flexibles conçus pour l'extérieur. Clou métallique pour l'installation au sol, à commander séparément.

LED COB light source included. Integrated electric power supply 220-240V ON/OFF and adjustable 1-10V or DALI. Fixing plate included. The electrical connection is made on the inside of the plate by means of a watertight connector included. To guarantee its water tightness, it is recommended to use flexible cables designed for outdoor use. Ground spike for ground installations to be ordered separately.

Optic Spot 22°

CoB Led: 19,5W - 2197 lm ≠ FIXT 1939 lm - 2700K/CRI 80 - 220-240V / 19,5W - 2367 lm ≠ FIXT 2085 lm - 3000K/CRI 80 - 220-240V / 19,5W - 2497 lm ≠ FIXT 2120 lm - 4000K/CRI 80 - 220-240V

2700K		3000K		4000K	
Non Dimmable		Non Dimmable		Non Dimmable	
○ F026A2BA001.A	475,00 €	○ F026A3BA001	475,00 €	○ F026A4BA001.A	475,00 €
● F026A2BA006.A	475,00 €	● F026A3BA006	475,00 €	● F026A4BA006.A	475,00 €
● F026A2BA012.A	475,00 €	● F026A3BA012	475,00 €	● F026A4BA012.A	475,00 €
● F026A2BA018.A	475,00 €	● F026A3BA018	475,00 €	● F026A4BA018.A	475,00 €
● F026A2BA030.A	475,00 €	● F026A3BA030	475,00 €	● F026A4BA030.A	475,00 €
● F026A2BA033.A	475,00 €	● F026A3BA033	475,00 €	● F026A4BA033.A	475,00 €
1-10V		1-10V		1-10V	
○ F026A2BB001.A	517,00 €	○ F026A3BB001	517,00 €	○ F026A4BB001.A	517,00 €
● F026A2BB006.A	517,00 €	● F026A3BB006	517,00 €	● F026A4BB006.A	517,00 €
● F026A2BB012.A	517,00 €	● F026A3BB012	517,00 €	● F026A4BB012.A	517,00 €
● F026A2BB018.A	517,00 €	● F026A3BB018	517,00 €	● F026A4BB018.A	517,00 €
● F026A2BB030.A	517,00 €	● F026A3BB030	517,00 €	● F026A4BB030.A	517,00 €
● F026A2BB033.A	517,00 €	● F026A3BB033	517,00 €	● F026A4BB033.A	517,00 €
Dali		Dali		Dali	
○ F026A2BD001.A	517,00 €	○ F026A3BD001	517,00 €	○ F026A4BD001.A	517,00 €
● F026A2BD006.A	517,00 €	● F026A3BD006	517,00 €	● F026A4BD006.A	517,00 €
● F026A2BD012.A	517,00 €	● F026A3BD012	517,00 €	● F026A4BD012.A	517,00 €
● F026A2BD018.A	517,00 €	● F026A3BD018	517,00 €	● F026A4BD018.A	517,00 €
● F026A2BD030.A	517,00 €	● F026A3BD030	517,00 €	● F026A4BD030.A	517,00 €
● F026A2BD033.A	517,00 €	● F026A3BD033	517,00 €	● F026A4BD033.A	517,00 €

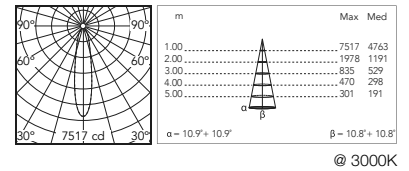

Optic Medium Flood 43°

CoB Led: 19,5W - 2197 lm ≠ FIXT 2026 lm - 2700K/CRI 80 - 220-240V / 19,5W - 2367 lm ≠ FIXT 2178 lm - 3000K/CRI 80 - 220-240V / 19,5W - 2497 lm ≠ FIXT 2298 lm - 4000K/CRI 80 - 220-240V

2700K		3000K		4000K	
Non Dimmable		Non Dimmable		Non Dimmable	
○ F026A2CA001.A	475,00 €	○ F026A3CA001	475,00 €	○ F026A4CA001.A	475,00 €
● F026A2CA006.A	475,00 €	● F026A3CA006	475,00 €	● F026A4CA006.A	475,00 €
● F026A2CA012.A	475,00 €	● F026A3CA012	475,00 €	● F026A4CA012.A	475,00 €
● F026A2CA018.A	475,00 €	● F026A3CA018	475,00 €	● F026A4CA018.A	475,00 €
● F026A2CA030.A	475,00 €	● F026A3CA030	475,00 €	● F026A4CA030.A	475,00 €
● F026A2CA033.A	475,00 €	● F026A3CA033	475,00 €	● F026A4CA033.A	475,00 €
1-10V		1-10V		1-10V	
○ F026A2CB001.A	517,00 €	○ F026A3CB001	517,00 €	○ F026A4CB001.A	517,00 €
● F026A2CB006.A	517,00 €	● F026A3CB006	517,00 €	● F026A4CB006.A	517,00 €
● F026A2CB012.A	517,00 €	● F026A3CB012	517,00 €	● F026A4CB012.A	517,00 €
● F026A2CB018.A	517,00 €	● F026A3CB018	517,00 €	● F026A4CB018.A	517,00 €
● F026A2CB030.A	517,00 €	● F026A3CB030	517,00 €	● F026A4CB030.A	517,00 €
● F026A2CB033.A	517,00 €	● F026A3CB033	517,00 €	● F026A4CB033.A	517,00 €
Dali		Dali		Dali	
○ F026A2CD001.A	517,00 €	○ F026A3CD001	517,00 €	○ F026A4CD001.A	517,00 €
● F026A2CD006.A	517,00 €	● F026A3CD006	517,00 €	● F026A4CD006.A	517,00 €
● F026A2CD012.A	517,00 €	● F026A3CD012	517,00 €	● F026A4CD012.A	517,00 €
● F026A2CD018.A	517,00 €	● F026A3CD018	517,00 €	● F026A4CD018.A	517,00 €
● F026A2CD030.A	517,00 €	● F026A3CD030	517,00 €	● F026A4CD030.A	517,00 €
● F026A2CD033.A	517,00 €	● F026A3CD033	517,00 €	● F026A4CD033.A	517,00 €

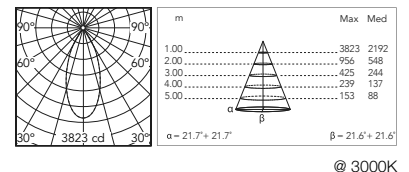

Spine 2 Absolute: Accessoires / Accessories

Pique de terre. Ground spike. F026Z010000 27,00 €



Honeycomb Honeycomb Louvre F026Z060000 21,00 €

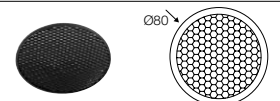

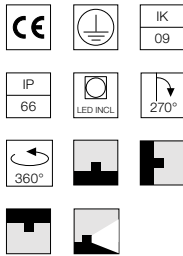
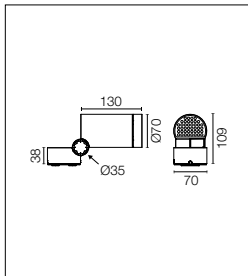

Source Power LED incluse. Équipée d'un snoot intégré pour un plus grand confort visuel. Les collimateurs sont des accessoires disponibles pour modifier la largeur du faisceau lumineux. Source d'alimentation électrique intégrée 220-240V ON/OFF. Plaque d'ancrage incluse. La connexion électrique a lieu à l'intérieur de la plaque par un connecteur étanche inclus. Pour garantir l'étanchéité, il est conseillé d'utiliser des câbles flexibles conçus pour l'extérieur. Clou métallique pour l'installation au sol, à commander séparément. Sur demande, version réglable 1-10V ou DALI avec source d'alimentation à distance 24Vdc.

Power LED source included. Equipped with an integrated snoot for higher visual comfort. Collimators are available as an accessory to modify the beam opening. Integrated electric power supply 220-240V ON/OFF. Fixing plate included. The electrical connection is made on the inside of the plate by means of a watertight connector included. To guarantee its water tightness, it is recommended to use flexible cables designed for outdoor use. Ground spike for ground installations to be ordered separately. Upon request: 1-10V or DALI dimmable version with 24Vdc remote power supply.

2200K disponible sur demande.

2200K available on request.

Optic Narrow Spot 7°

Power Led: 3,5W - 168 lm ≠ FIXT 143 lm - 2700K/CRI 80 - 220-240V / 3,5W - 174 lm ≠ FIXT 149 lm - 3000K/CRI 80 - 220-240V / 3,5W - 180 lm ≠ FIXT 154 lm - 4000K/CRI 80 - 220-240V

2700K Non Dimmable		3000K Non Dimmable		4000K Non Dimmable		
○ F025D2AA001	517,00 €	○ F025D3AA001	517,00 €	○ F025D4AA001	517,00 €	
● F025D2AA006	517,00 €	● F025D3AA006	517,00 €	● F025D4AA006	517,00 €	
● F025D2AA012	517,00 €	● F025D3AA012	517,00 €	● F025D4AA012	517,00 €	
● F025D2AA018	517,00 €	● F025D3AA018	517,00 €	● F025D4AA018	517,00 €	
● F025D2AA030	517,00 €	● F025D3AA030	517,00 €	● F025D4AA030	517,00 €	
● F025D2AA033	517,00 €	● F025D3AA033	517,00 €	● F025D4AA033	517,00 €	

Optic Spot 14°

Power Led: 7,9W - 671 lm ≠ FIXT 550 lm - 2700K/CRI 80 - 220-240V / 7,9W - 696 lm ≠ FIXT 571 lm - 3000K/CRI 80 - 220-240V / 7,9W - 720 lm ≠ FIXT 591 lm - 4000K/CRI 80 - 220-240V

2700K Non Dimmable		3000K Non Dimmable		4000K Non Dimmable		
○ F025D2BA001	517,00 €	○ F025D3BA001	517,00 €	○ F025D4BA001	517,00 €	
● F025D2BA006	517,00 €	● F025D3BA006	517,00 €	● F025D4BA006	517,00 €	
● F025D2BA012	517,00 €	● F025D3BA012	517,00 €	● F025D4BA012	517,00 €	
● F025D2BA018	517,00 €	● F025D3BA018	517,00 €	● F025D4BA018	517,00 €	
● F025D2BA030	517,00 €	● F025D3BA030	517,00 €	● F025D4BA030	517,00 €	
● F025D2BA033	517,00 €	● F025D3BA033	517,00 €	● F025D4BA033	517,00 €	

Optic Medium Flood 24,5°

Power Led: 7,9W - 671 lm ≠ FIXT 499 lm - 2700K/CRI 80 - 220-240V / 7,9W - 696 lm ≠ FIXT 518 lm - 3000K/CRI 80 - 220-240V / 7,9W - 720 lm ≠ FIXT 536 lm - 4000K/CRI 80 - 220-240V

2700K Non Dimmable		3000K Non Dimmable		4000K Non Dimmable		
○ F025D2CA001	517,00 €	○ F025D3CA001	517,00 €	○ F025D4CA001	517,00 €	
● F025D2CA006	517,00 €	● F025D3CA006	517,00 €	● F025D4CA006	517,00 €	
● F025D2CA012	517,00 €	● F025D3CA012	517,00 €	● F025D4CA012	517,00 €	
● F025D2CA018	517,00 €	● F025D3CA018	517,00 €	● F025D4CA018	517,00 €	
● F025D2CA030	517,00 €	● F025D3CA030	517,00 €	● F025D4CA030	517,00 €	
● F025D2CA033	517,00 €	● F025D3CA033	517,00 €	● F025D4CA033	517,00 €	

Optic Flood 32°

Power Led: 7,9W - 671 lm ≠ FIXT 482 lm - 2700K/CRI 80 - 220-240V / 7,9W - 696 lm ≠ FIXT 500 lm - 3000K/CRI 80 - 220-240V / 7,9W - 720 lm ≠ FIXT 518 lm - 4000K/CRI 80 - 220-240V

2700K Non Dimmable		3000K Non Dimmable		4000K Non Dimmable		
○ F025D2DA001	517,00 €	○ F025D3DA001	517,00 €	○ F025D4DA001	517,00 €	
● F025D2DA006	517,00 €	● F025D3DA006	517,00 €	● F025D4DA006	517,00 €	
● F025D2DA012	517,00 €	● F025D3DA012	517,00 €	● F025D4DA012	517,00 €	
● F025D2DA018	517,00 €	● F025D3DA018	517,00 €	● F025D4DA018	517,00 €	
● F025D2DA030	517,00 €	● F025D3DA030	517,00 €	● F025D4DA030	517,00 €	
● F025D2DA033	517,00 €	● F025D3DA033	517,00 €	● F025D4DA033	517,00 €	

Spine 1 Pro

Optic Wide Flood 49°

Power Led: 7,9W - 671 lm ≠ FIXT 480 lm - 2700K/CRI 80 - 220-240V / 7,9W - 696 lm ≠ FIXT 490 lm - 3000K/CRI 80 - 220-240V / 7,9W - 720 lm ≠ FIXT 505 lm - 4000K/CRI 80 - 220-240V

2700K

Non Dimmable

- F025D2EA001 517,00 €
- F025D2EA006 517,00 €
- F025D2EA012 517,00 €
- F025D2EA018 517,00 €
- F025D2EA030 517,00 €
- F025D2EA033 517,00 €

3000K

Non Dimmable

- F025D3EA001 517,00 €
- F025D3EA006 517,00 €
- F025D3EA012 517,00 €
- F025D3EA018 517,00 €
- F025D3EA030 517,00 €
- F025D3EA033 517,00 €

4000K

Non Dimmable

- F025D4EA001 517,00 €
- F025D4EA006 517,00 €
- F025D4EA012 517,00 €
- F025D4EA018 517,00 €
- F025D4EA030 517,00 €
- F025D4EA033 517,00 €

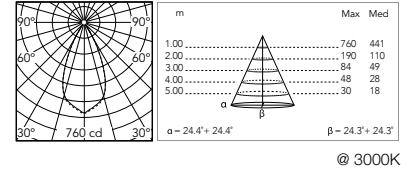

Optic Elliptical 1 13,5° x 50°

Power Led: 7,9W - 671 lm ≠ FIXT 500 lm - 2700K/CRI 80 - 220-240V / 7,9W - 696 lm ≠ FIXT 519 lm - 3000K/CRI 80 - 220-240V / 7,9W - 720 lm ≠ FIXT 537 lm - 4000K/CRI 80 - 220-240V

2700K

Non Dimmable

- F025D2FA001 517,00 €
- F025D2FA006 517,00 €
- F025D2FA012 517,00 €
- F025D2FA018 517,00 €
- F025D2FA030 517,00 €
- F025D2FA033 517,00 €

3000K

Non Dimmable

- F025D3FA001 517,00 €
- F025D3FA006 517,00 €
- F025D3FA012 517,00 €
- F025D3FA018 517,00 €
- F025D3FA030 517,00 €
- F025D3FA033 517,00 €

4000K

Non Dimmable

- F025D4FA001 517,00 €
- F025D4FA006 517,00 €
- F025D4FA012 517,00 €
- F025D4FA018 517,00 €
- F025D4FA030 517,00 €
- F025D4FA033 517,00 €

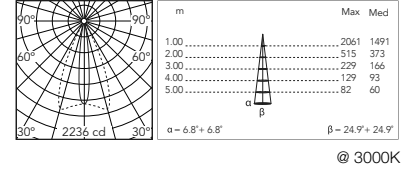

Optic Elliptical 2 26° x 51°

Power Led: 7,9W - 671 lm ≠ FIXT 487 lm - 2700K/CRI 80 - 220-240V / 7,9W - 696 lm ≠ FIXT 505 lm - 3000K/CRI 80 - 220-240V / 7,9W - 720 lm ≠ FIXT 523 lm - 4000K/CRI 80 - 220-240V

2700K

Non Dimmable

- F025D2GA001 517,00 €
- F025D2GA006 517,00 €
- F025D2GA012 517,00 €
- F025D2GA018 517,00 €
- F025D2GA030 517,00 €
- F025D2GA033 517,00 €

3000K

Non Dimmable

- F025D3GA001 517,00 €
- F025D3GA006 517,00 €
- F025D3GA012 517,00 €
- F025D3GA018 517,00 €
- F025D3GA030 517,00 €
- F025D3GA033 517,00 €

4000K

Non Dimmable

- F025D4GA001 517,00 €
- F025D4GA006 517,00 €
- F025D4GA012 517,00 €
- F025D4GA018 517,00 €
- F025D4GA030 517,00 €
- F025D4GA033 517,00 €

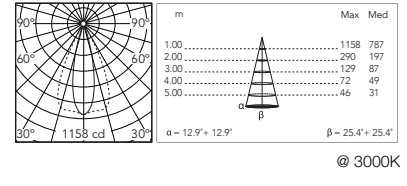

Optic Wall Washer

Power Led: 7,9W - 671 lm ≠ FIXT 471 lm - 2700K/CRI 80 - 220-240V / 7,9W - 696 lm ≠ FIXT 489 lm - 3000K/CRI 80 - 220-240V / 7,9W - 720 lm ≠ FIXT 506 lm - 4000K/CRI 80 - 220-240V

2700K

Non Dimmable

- F025D2HA001 517,00 €
- F025D2HA006 517,00 €
- F025D2HA012 517,00 €
- F025D2HA018 517,00 €
- F025D2HA030 517,00 €
- F025D2HA033 517,00 €

3000K

Non Dimmable

- F025D3HA001 517,00 €
- F025D3HA006 517,00 €
- F025D3HA012 517,00 €
- F025D3HA018 517,00 €
- F025D3HA030 517,00 €
- F025D3HA033 517,00 €

4000K

Non Dimmable

- F025D4HA001 517,00 €
- F025D4HA006 517,00 €
- F025D4HA012 517,00 €
- F025D4HA018 517,00 €
- F025D4HA030 517,00 €
- F025D4HA033 517,00 €

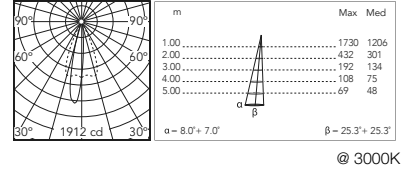

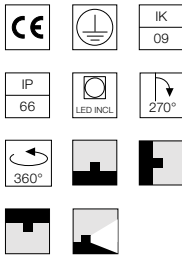
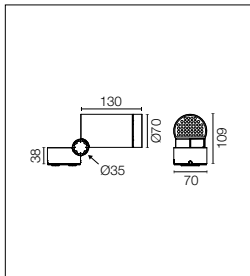

Source LED à base consommation incluse. Équipée d'un snoot intégré pour un plus grand confort visuel. Les collimateurs sont des accessoires disponibles pour modifier la largeur du faisceau lumineux. Source d'alimentation électrique intégrée 220-240V ON/OFF. Plaque d'ancrage incluse. La connexion électrique a lieu à l'intérieur de la plaque par un connecteur étanche inclus. Pour garantir l'étanchéité, il est conseillé d'utiliser des câbles flexibles conçus pour l'extérieur. Clou métallique pour l'installation au sol, à commander séparément. Sur commande, version réglable 1-10V ou DALI avec source d'alimentation à distance 24Vdc.

Energy-efficient Power LED source included Equipped with an integrated snoot for higher visual comfort. Collimators are available as an accessory to modify the beam opening. Integrated electric power supply 220-240V ON/OFF. Fixing plate included. The electrical connection is made on the inside of the plate by means of a watertight connector included. To guarantee its water tightness, it is recommended to use flexible cables designed for outdoor use. Ground spike for ground installations to be ordered separately. Upon request: 1-10V or DALI dimmable version with 24Vdc remote power supply.

Optic Spot 12°

Power Led: 10,5W - 920 lm ≠ FIXT 680 lm - 2700K/CRI 80 - 220-240V / 10,5W - 966 lm ≠ FIXT 706 lm - 3000K/CRI 80 - 220-240V / 10,5W - 1012 lm ≠ FIXT 730 lm - 4000K/CRI 80 - 220-240V

2700K

Non Dimmable

- F025E2BA001 517,00 €
- F025E2BA006 517,00 €
- F025E2BA012 517,00 €
- F025E2BA018 517,00 €
- F025E2BA030 517,00 €
- F025E2BA033 517,00 €

3000K

Non Dimmable

- F025E3BA001 517,00 €
- F025E3BA006 517,00 €
- F025E3BA012 517,00 €
- F025E3BA018 517,00 €
- F025E3BA030 517,00 €
- F025E3BA033 517,00 €

4000K

Non Dimmable

- F025E4BA001 517,00 €
- F025E4BA006 517,00 €
- F025E4BA012 517,00 €
- F025E4BA018 517,00 €
- F025E4BA030 517,00 €
- F025E4BA033 517,00 €

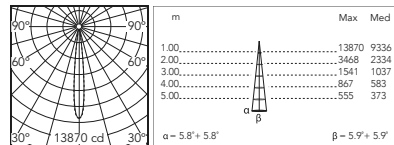

@ 3000K

Optic Medium Flood 26,5°

Power Led: 10,5W - 920 lm ≠ FIXT 594 lm - 2700K/CRI 80 - 220-240V / 10,5W - 966 lm ≠ FIXT 630 lm - 3000K/CRI 80 - 220-240V / 10,5W - 1012 lm ≠ FIXT 654 lm - 4000K/CRI 80 - 220-240V

2700K

Non Dimmable

- F025E2CA001 517,00 €
- F025E2CA006 517,00 €
- F025E2CA012 517,00 €
- F025E2CA018 517,00 €
- F025E2CA030 517,00 €
- F025E2CA033 517,00 €

3000K

Non Dimmable

- F025E3CA001 517,00 €
- F025E3CA006 517,00 €
- F025E3CA012 517,00 €
- F025E3CA018 517,00 €
- F025E3CA030 517,00 €
- F025E3CA033 517,00 €

4000K

Non Dimmable

- F025E4CA001 517,00 €
- F025E4CA006 517,00 €
- F025E4CA012 517,00 €
- F025E4CA018 517,00 €
- F025E4CA030 517,00 €
- F025E4CA033 517,00 €

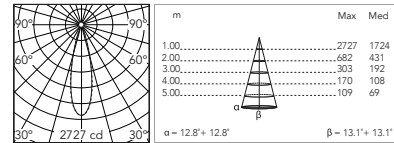

@ 3000K

Optic Flood 33,5°

Power Led: 10,5W - 920 lm ≠ FIXT 592 lm - 2700K/CRI 80 - 220-240V / 10,5W - 966 lm ≠ FIXT 627 lm - 3000K/CRI 80 - 220-240V / 10,5W - 1012 lm ≠ FIXT 651 lm - 4000K/CRI 80 - 220-240V

2700K

Non Dimmable

- F025E2DA001 517,00 €
- F025E2DA006 517,00 €
- F025E2DA012 517,00 €
- F025E2DA018 517,00 €
- F025E2DA030 517,00 €
- F025E2DA033 517,00 €

3000K

Non Dimmable

- F025E3DA001 517,00 €
- F025E3DA006 517,00 €
- F025E3DA012 517,00 €
- F025E3DA018 517,00 €
- F025E3DA030 517,00 €
- F025E3DA033 517,00 €

4000K

Non Dimmable

- F025E4DA001 517,00 €
- F025E4DA006 517,00 €
- F025E4DA012 517,00 €
- F025E4DA018 517,00 €
- F025E4DA030 517,00 €
- F025E4DA033 517,00 €

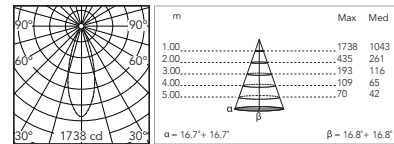

@ 3000K

Optic Wide Flood 50°

Power Led: 10,5W - 920 lm ≠ FIXT 591 lm - 2700K/CRI 80 - 220-240V / 10,5W - 966 lm ≠ FIXT 619 lm - 3000K/CRI 80 - 220-240V / 10,5W - 1012 lm ≠ FIXT 650 lm - 4000K/CRI 80 - 220-240V

2700K

Non Dimmable

- F025E2EA001 517,00 €
- F025E2EA006 517,00 €
- F025E2EA012 517,00 €
- F025E2EA018 517,00 €
- F025E2EA030 517,00 €
- F025E2EA033 517,00 €

3000K

Non Dimmable

- F025E3EA001 517,00 €
- F025E3EA006 517,00 €
- F025E3EA012 517,00 €
- F025E3EA018 517,00 €
- F025E3EA030 517,00 €
- F025E3EA033 517,00 €

4000K

Non Dimmable

- F025E4EA001 517,00 €
- F025E4EA006 517,00 €
- F025E4EA012 517,00 €
- F025E4EA018 517,00 €
- F025E4EA030 517,00 €
- F025E4EA033 517,00 €

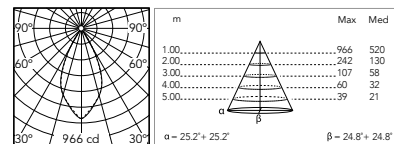

@ 3000K

Spine 1 Pro Hp

Optic Elliptical 1 11,5° x 49°

Power Led: 10,5W - 920 lm ≠ FIXT 603 lm - 2700K/CRI 80 - 220-240V / 10,5W - 966 lm ≠ FIXT 639 lm - 3000K/CRI 80 - 220-240V / 10,5W - 1012 lm ≠ FIXT 663 lm - 4000K/CRI 80 - 220-240V

2700K

Non Dimmable

○ F025E2FA001	517,00 €
● F025E2FA006	517,00 €
● F025E2FA012	517,00 €
● F025E2FA018	517,00 €
● F025E2FA030	517,00 €
● F025E2FA033	517,00 €

3000K

Non Dimmable

○ F025E3FA001	517,00 €
● F025E3FA006	517,00 €
● F025E3FA012	517,00 €
● F025E3FA018	517,00 €
● F025E3FA030	517,00 €
● F025E3FA033	517,00 €

4000K

Non Dimmable

○ F025E4FA001	517,00 €
● F025E4FA006	517,00 €
● F025E4FA012	517,00 €
● F025E4FA018	517,00 €
● F025E4FA030	517,00 €
● F025E4FA033	517,00 €

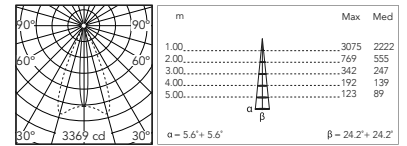

@ 3000K

Optic Elliptical 2 25,5° x 50°

Power Led: 10,5W - 920 lm ≠ FIXT 601 lm - 2700K/CRI 80 - 220-240V / 10,5W - 966 lm ≠ FIXT 624 lm - 3000K/CRI 80 - 220-240V / 10,5W - 1012 lm ≠ FIXT 645 lm - 4000K/CRI 80 - 220-240V

2700K

Non Dimmable

○ F025E2GA001	517,00 €
● F025E2GA006	517,00 €
● F025E2GA012	517,00 €
● F025E2GA018	517,00 €
● F025E2GA030	517,00 €
● F025E2GA033	517,00 €

3000K

Non Dimmable

○ F025E3GA001	517,00 €
● F025E3GA006	517,00 €
● F025E3GA012	517,00 €
● F025E3GA018	517,00 €
● F025E3GA030	517,00 €
● F025E3GA033	517,00 €

4000K

Non Dimmable

○ F025E4GA001	517,00 €
● F025E4GA006	517,00 €
● F025E4GA012	517,00 €
● F025E4GA018	517,00 €
● F025E4GA030	517,00 €
● F025E4GA033	517,00 €

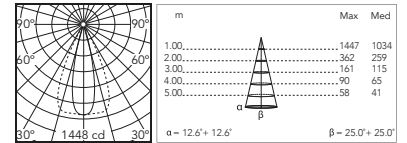

@ 3000K

Optic Wall Washer

Power Led: 10,5W - 920 lm ≠ FIXT 574 lm - 2700K/CRI 80 - 220-240V / 10,5W - 966 lm ≠ FIXT 609 lm - 3000K/CRI 80 - 220-240V / 10,5W - 1012 lm ≠ FIXT 631 lm - 4000K/CRI 80 - 220-240V

2700K

Non Dimmable

○ F025E2HA001	517,00 €
● F025E2HA006	517,00 €
● F025E2HA012	517,00 €
● F025E2HA018	517,00 €
● F025E2HA030	517,00 €
● F025E2HA033	517,00 €

3000K

Non Dimmable

○ F025E3HA001	517,00 €
● F025E3HA006	517,00 €
● F025E3HA012	517,00 €
● F025E3HA018	517,00 €
● F025E3HA030	517,00 €
● F025E3HA033	517,00 €

4000K

Non Dimmable

○ F025E4HA001	517,00 €
● F025E4HA006	517,00 €
● F025E4HA012	517,00 €
● F025E4HA018	517,00 €
● F025E4HA030	517,00 €
● F025E4HA033	517,00 €

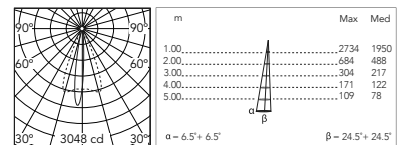

@ 3000K

Spine 1 Pro: Accessoires / Accessories

Pique de terre. Ground spike. F026Z010000 27,00 €

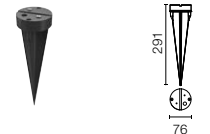

Honeycomb Honeycomb Louvre F025Z060000 20,00 €



Lentilles de conversion / Converter lenses:

- Converter Spine 0 / Spine 1 Optic Medium Flood	F029Z010000	35,00 €
- Converter Spine 0 / Spine 1 Optic Flood	F029Z011000	35,00 €
- Converter Spine 0 / Spine 1 Optic Wide Flood	F029Z012000	35,00 €
- Converter Spine 0 / Spine 1 Optic Elliptic 1	F029Z013000	35,00 €
- Converter Spine 0 / Spine 1 Optic Elliptic 2	F029Z014000	35,00 €
- Converter Spine 0 / Spine 1 Optic Wall Washer	F029Z015000	35,00 €



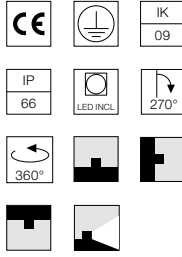
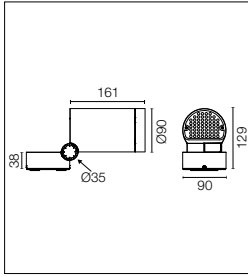

Source Power LED incluse. Équipée d'un snoot intégré pour un plus grand confort visuel. Les collimateurs sont des accessoires disponibles pour modifier la largeur du faisceau lumineux. Source d'alimentation électrique intégrée 220-240V ON/OFF et réglable 1-10V ou DALI. Plaque d'ancrage incluse. La connexion électrique a lieu à l'intérieur de la plaque par un connecteur étanche inclus. Pour garantir l'étanchéité, il est conseillé d'utiliser des câbles flexibles conçus pour l'extérieur. Clou métallique pour l'installation au sol, à commander séparément.

Power LED source included. Equipped with an integrated snoot for higher visual comfort. Collimators are available as an accessory to modify the beam opening. Integrated electric power supply 220-240V ON/OFF and adjustable 1-10V or DALI. Fixing plate included. The electrical connection is made on the inside of the plate by means of a watertight connector included. To guarantee its watertightness, it is recommended to use flexible cables designed for outdoor use. Ground spike for ground installations to be ordered separately.

Optic Narrow Spot
2200K disponible sur demande.

Optic Narrow Spot
2200K available on request.

Optic Narrow Spot 6°

Power Led: 4,1W - 248 lm ≠ FIXT 230 lm - 2700K/CRI 80 - 220-240V / 4,1W - 258 lm ≠ FIXT 239 lm - 3000K/CRI 80 - 220-240V / 4,1W - 267 lm ≠ FIXT 247 lm - 4000K/CRI 80 - 220-240V

2700K		3000K		4000K	
Non Dimmable		Non Dimmable		Non Dimmable	
○ F026D2AA001	621,00 €	○ F026D3AA001	621,00 €	○ F026D4AA001	621,00 €
● F026D2AA006	621,00 €	● F026D3AA006	621,00 €	● F026D4AA006	621,00 €
● F026D2AA012	621,00 €	● F026D3AA012	621,00 €	● F026D4AA012	621,00 €
● F026D2AA018	621,00 €	● F026D3AA018	621,00 €	● F026D4AA018	621,00 €
● F026D2AA030	621,00 €	● F026D3AA030	621,00 €	● F026D4AA030	621,00 €
● F026D2AA033	621,00 €	● F026D3AA033	621,00 €	● F026D4AA033	621,00 €
1-10V					
○ F026D2AB001	670,00 €	○ F026D3AB001	670,00 €	○ F026D4AB001	670,00 €
● F026D2AB006	670,00 €	● F026D3AB006	670,00 €	● F026D4AB006	670,00 €
● F026D2AB012	670,00 €	● F026D3AB012	670,00 €	● F026D4AB012	670,00 €
● F026D2AB018	670,00 €	● F026D3AB018	670,00 €	● F026D4AB018	670,00 €
● F026D2AB030	670,00 €	● F026D3AB030	670,00 €	● F026D4AB030	670,00 €
● F026D2AB033	670,00 €	● F026D3AB033	670,00 €	● F026D4AB033	670,00 €
Dali					
○ F026D2AD001	670,00 €	○ F026D3AD001	670,00 €	○ F026D4AD001	670,00 €
● F026D2AD006	670,00 €	● F026D3AD006	670,00 €	● F026D4AD006	670,00 €
● F026D2AD012	670,00 €	● F026D3AD012	670,00 €	● F026D4AD012	670,00 €
● F026D2AD018	670,00 €	● F026D3AD018	670,00 €	● F026D4AD018	670,00 €
● F026D2AD030	670,00 €	● F026D3AD030	670,00 €	● F026D4AD030	670,00 €
● F026D2AD033	670,00 €	● F026D3AD033	670,00 €	● F026D4AD033	670,00 €

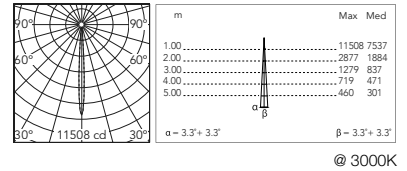

Optic Spot 9,5°

Power Led: 10,5W - 920 lm ≠ FIXT 769 lm - 2700K/CRI 80 - 220-240V / 10,5W - 966 lm ≠ FIXT 808 lm - 3000K/CRI 80 - 220-240V / 10,5W - 1012 lm ≠ FIXT 846 lm - 4000K/CRI 80 - 220-240V

2700K		3000K		4000K	
Non Dimmable		Non Dimmable		Non Dimmable	
○ F026D2BA001	621,00 €	○ F026D3BA001	621,00 €	○ F026D4BA001	621,00 €
● F026D2BA006	621,00 €	● F026D3BA006	621,00 €	● F026D4BA006	621,00 €
● F026D2BA012	621,00 €	● F026D3BA012	621,00 €	● F026D4BA012	621,00 €
● F026D2BA018	621,00 €	● F026D3BA018	621,00 €	● F026D4BA018	621,00 €
● F026D2BA030	621,00 €	● F026D3BA030	621,00 €	● F026D4BA030	621,00 €
● F026D2BA033	621,00 €	● F026D3BA033	621,00 €	● F026D4BA033	621,00 €
1-10V					
○ F026D2BB001	670,00 €	○ F026D3BB001	670,00 €	○ F026D4BB001	670,00 €
● F026D2BB006	670,00 €	● F026D3BB006	670,00 €	● F026D4BB006	670,00 €
● F026D2BB012	670,00 €	● F026D3BB012	670,00 €	● F026D4BB012	670,00 €
● F026D2BB018	670,00 €	● F026D3BB018	670,00 €	● F026D4BB018	670,00 €
● F026D2BB030	670,00 €	● F026D3BB030	670,00 €	● F026D4BB030	670,00 €
● F026D2BB033	670,00 €	● F026D3BB033	670,00 €	● F026D4BB033	670,00 €
Dali					
○ F026D2BD001	670,00 €	○ F026D3BD001	670,00 €	○ F026D4BD001	670,00 €
● F026D2BD006	670,00 €	● F026D3BD006	670,00 €	● F026D4BD006	670,00 €
● F026D2BD012	670,00 €	● F026D3BD012	670,00 €	● F026D4BD012	670,00 €
● F026D2BD018	670,00 €	● F026D3BD018	670,00 €	● F026D4BD018	670,00 €
● F026D2BD030	670,00 €	● F026D3BD030	670,00 €	● F026D4BD030	670,00 €
● F026D2BD033	670,00 €	● F026D3BD033	670,00 €	● F026D4BD033	670,00 €

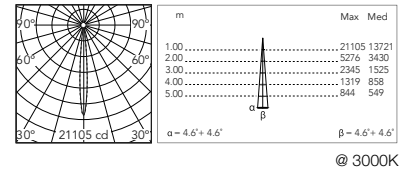

Optic Medium Flood 28°

Power Led: 10,5W - 920 lm ≠ FIXT 715 lm - 2700K/CRI 80 - 220-240V / 10,5W - 966 lm ≠ FIXT 742 lm - 3000K/CRI 80 - 220-240V / 10,5W - 1012 lm ≠ FIXT 767 lm - 4000K/CRI 80 - 220-240V

2700K		3000K		4000K	
Non Dimmable		Non Dimmable		Non Dimmable	
○ F026D2CA001	621,00 €	○ F026D3CA001	621,00 €	○ F026D4CA001	621,00 €
● F026D2CA006	621,00 €	● F026D3CA006	621,00 €	● F026D4CA006	621,00 €
● F026D2CA012	621,00 €	● F026D3CA012	621,00 €	● F026D4CA012	621,00 €
● F026D2CA018	621,00 €	● F026D3CA018	621,00 €	● F026D4CA018	621,00 €
● F026D2CA030	621,00 €	● F026D3CA030	621,00 €	● F026D4CA030	621,00 €
● F026D2CA033	621,00 €	● F026D3CA033	621,00 €	● F026D4CA033	621,00 €
1-10V					
○ F026D2CB001	670,00 €	○ F026D3CB001	670,00 €	○ F026D4CB001	670,00 €
● F026D2CB006	670,00 €	● F026D3CB006	670,00 €	● F026D4CB006	670,00 €
● F026D2CB012	670,00 €	● F026D3CB012	670,00 €	● F026D4CB012	670,00 €
● F026D2CB018	670,00 €	● F026D3CB018	670,00 €	● F026D4CB018	670,00 €
● F026D2CB030	670,00 €	● F026D3CB030	670,00 €	● F026D4CB030	670,00 €
● F026D2CB033	670,00 €	● F026D3CB033	670,00 €	● F026D4CB033	670,00 €
Dali					
○ F026D2CD001	670,00 €	○ F026D3CD001	670,00 €	○ F026D4CD001	670,00 €
● F026D2CD006	670,00 €	● F026D3CD006	670,00 €	● F026D4CD006	670,00 €
● F026D2CD012	670,00 €	● F026D3CD012	670,00 €	● F026D4CD012	670,00 €
● F026D2CD018	670,00 €	● F026D3CD018	670,00 €	● F026D4CD018	670,00 €
● F026D2CD030	670,00 €	● F026D3CD030	670,00 €	● F026D4CD030	670,00 €
● F026D2CD033	670,00 €	● F026D3CD033	670,00 €	● F026D4CD033	670,00 €

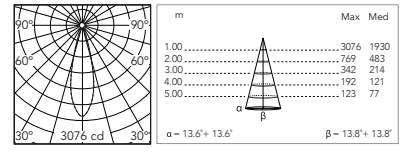

@ 3000K

Optic Flood 33°

Power Led: 10,5W - 920 lm ≠ FIXT 695 lm - 2700K/CRI 80 - 220-240V / 10,5W - 966 lm ≠ FIXT 721 lm - 3000K/CRI 80 - 220-240V / 10,5W - 1012 lm ≠ FIXT 746 lm - 4000K/CRI 80 - 220-240V

2700K		3000K		4000K	
Non Dimmable		Non Dimmable		Non Dimmable	
○ F026D2DA001	621,00 €	○ F026D3DA001	621,00 €	○ F026D4DA001	621,00 €
● F026D2DA006	621,00 €	● F026D3DA006	621,00 €	● F026D4DA006	621,00 €
● F026D2DA012	621,00 €	● F026D3DA012	621,00 €	● F026D4DA012	621,00 €
● F026D2DA018	621,00 €	● F026D3DA018	621,00 €	● F026D4DA018	621,00 €
● F026D2DA030	621,00 €	● F026D3DA030	621,00 €	● F026D4DA030	621,00 €
● F026D2DA033	621,00 €	● F026D3DA033	621,00 €	● F026D4DA033	621,00 €
1-10V					
○ F026D2DB001	670,00 €	○ F026D3DB001	670,00 €	○ F026D4DB001	670,00 €
● F026D2DB006	670,00 €	● F026D3DB006	670,00 €	● F026D4DB006	670,00 €
● F026D2DB012	670,00 €	● F026D3DB012	670,00 €	● F026D4DB012	670,00 €
● F026D2DB018	670,00 €	● F026D3DB018	670,00 €	● F026D4DB018	670,00 €
● F026D2DB030	670,00 €	● F026D3DB030	670,00 €	● F026D4DB030	670,00 €
● F026D2DB033	670,00 €	● F026D3DB033	670,00 €	● F026D4DB033	670,00 €
Dali					
○ F026D2DD001	670,00 €	○ F026D3DD001	670,00 €	○ F026D4DD001	670,00 €
● F026D2DD006	670,00 €	● F026D3DD006	670,00 €	● F026D4DD006	670,00 €
● F026D2DD012	670,00 €	● F026D3DD012	670,00 €	● F026D4DD012	670,00 €
● F026D2DD018	670,00 €	● F026D3DD018	670,00 €	● F026D4DD018	670,00 €
● F026D2DD030	670,00 €	● F026D3DD030	670,00 €	● F026D4DD030	670,00 €
● F026D2DD033	670,00 €	● F026D3DD033	670,00 €	● F026D4DD033	670,00 €

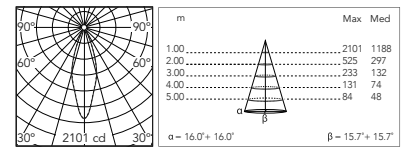

@ 3000K

Optic Wide Flood 51°

Power Led: 10,5W - 920 lm ≠ FIXT 711 lm - 2700K/CRI 80 - 220-240V / 10,5W - 966 lm ≠ FIXT 741 lm - 3000K/CRI 80 - 220-240V / 10,5W - 1012 lm ≠ FIXT 778 lm - 4000K/CRI 80 - 220-240V

2700K		3000K		4000K	
Non Dimmable		Non Dimmable		Non Dimmable	
○ F026D2EA001	621,00 €	○ F026D3EA001	621,00 €	○ F026D4EA001	621,00 €
● F026D2EA006	621,00 €	● F026D3EA006	621,00 €	● F026D4EA006	621,00 €
● F026D2EA012	621,00 €	● F026D3EA012	621,00 €	● F026D4EA012	621,00 €
● F026D2EA018	621,00 €	● F026D3EA018	621,00 €	● F026D4EA018	621,00 €
● F026D2EA030	621,00 €	● F026D3EA030	621,00 €	● F026D4EA030	621,00 €
● F026D2EA033	621,00 €	● F026D3EA033	621,00 €	● F026D4EA033	621,00 €
1-10V					
○ F026D2EB001	670,00 €	○ F026D3EB001	670,00 €	○ F026D4EB001	670,00 €
● F026D2EB006	670,00 €	● F026D3EB006	670,00 €	● F026D4EB006	670,00 €
● F026D2EB012	670,00 €	● F026D3EB012	670,00 €	● F026D4EB012	670,00 €
● F026D2EB018	670,00 €	● F026D3EB018	670,00 €	● F026D4EB018	670,00 €
● F026D2EB030	670,00 €	● F026D3EB030	670,00 €	● F026D4EB030	670,00 €
● F026D2EB033	670,00 €	● F026D3EB033	670,00 €	● F026D4EB033	670,00 €
Dali					
○ F026D2ED001	670,00 €	○ F026D3ED001	670,00 €	○ F026D4ED001	670,00 €
● F026D2ED006	670,00 €	● F026D3ED006	670,00 €	● F026D4ED006	670,00 €
● F026D2ED012	670,00 €	● F026D3ED012	670,00 €	● F026D4ED012	670,00 €
● F026D2ED018	670,00 €	● F026D3ED018	670,00 €	● F026D4ED018	670,00 €
● F026D2ED030	670,00 €	● F026D3ED030	670,00 €	● F026D4ED030	670,00 €
● F026D2ED033	670,00 €	● F026D3ED033	670,00 €	● F026D4ED033	670,00 €

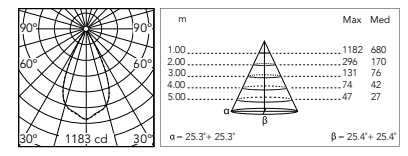

@ 3000K

Spine 2 Pro

Optic Elliptical 1 9,5° x 48°

Power Led: 10,5W - 920 lm ≠ FIXT 717 lm - 2700K/CRI 80 - 220-240V / 10,5W - 966 lm ≠ FIXT 744 lm - 3000K/CRI 80 - 220-240V / 10,5W - 1012 lm ≠ FIXT 770 lm - 4000K/CRI 80 - 220-240V

2700K

Non Dimmable

○ F026D2FA001	621,00 €
● F026D2FA006	621,00 €
● F026D2FA012	621,00 €
● F026D2FA018	621,00 €
● F026D2FA030	621,00 €
● F026D2FA033	621,00 €
1-10V	
○ F026D2FB001	670,00 €
○ F026D2FB006	670,00 €
● F026D2FB012	670,00 €
● F026D2FB018	670,00 €
● F026D2FB030	670,00 €
● F026D2FB033	670,00 €
Dali	
○ F026D2FD001	670,00 €
○ F026D2FD006	670,00 €
● F026D2FD012	670,00 €
● F026D2FD018	670,00 €
● F026D2FD030	670,00 €
● F026D2FD033	670,00 €

3000K

Non Dimmable

○ F026D3FA001	621,00 €
● F026D3FA006	621,00 €
● F026D3FA012	621,00 €
● F026D3FA018	621,00 €
● F026D3FA030	621,00 €
● F026D3FA033	621,00 €
1-10V	
○ F026D3FB001	670,00 €
○ F026D3FB006	670,00 €
● F026D3FB012	670,00 €
● F026D3FB018	670,00 €
● F026D3FB030	670,00 €
● F026D3FB033	670,00 €
Dali	
○ F026D3FD001	670,00 €
○ F026D3FD006	670,00 €
● F026D3FD012	670,00 €
● F026D3FD018	670,00 €
● F026D3FD030	670,00 €
● F026D3FD033	670,00 €

4000K

Non Dimmable

○ F026D4FA001	621,00 €
● F026D4FA006	621,00 €
● F026D4FA012	621,00 €
● F026D4FA018	621,00 €
● F026D4FA030	621,00 €
● F026D4FA033	621,00 €
1-10V	
○ F026D4FB001	670,00 €
○ F026D4FB006	670,00 €
● F026D4FB012	670,00 €
● F026D4FB018	670,00 €
● F026D4FB030	670,00 €
● F026D4FB033	670,00 €
Dali	
○ F026D4FD001	670,00 €
○ F026D4FD006	670,00 €
● F026D4FD012	670,00 €
● F026D4FD018	670,00 €
● F026D4FD030	670,00 €
● F026D4FD033	670,00 €

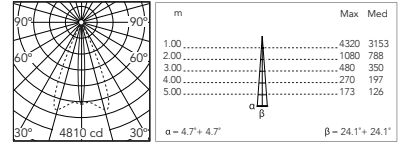

@ 3000K

Optic Elliptical 2 24° x 50°

Power Led: 10,5W - 920 lm ≠ FIXT 699 lm - 2700K/CRI 80 - 220-240V / 10,5W - 966 lm ≠ FIXT 725 lm - 3000K/CRI 80 - 220-240V / 10,5W - 1012 lm ≠ FIXT 750 lm - 4000K/CRI 80 - 220-240V

2700K

Non Dimmable

○ F026D2GA001	621,00 €
○ F026D2GA006	621,00 €
● F026D2GA012	621,00 €
● F026D2GA018	621,00 €
● F026D2GA030	621,00 €
● F026D2GA033	621,00 €
1-10V	
○ F026D2GB001	670,00 €
○ F026D2GB006	670,00 €
● F026D2GB012	670,00 €
● F026D2GB018	670,00 €
● F026D2GB030	670,00 €
● F026D2GB033	670,00 €
Dali	
○ F026D2GD001	670,00 €
○ F026D2GD006	670,00 €
● F026D2GD012	670,00 €
● F026D2GD018	670,00 €
● F026D2GD030	670,00 €
● F026D2GD033	670,00 €

3000K

Non Dimmable

○ F026D3GA001	621,00 €
○ F026D3GA006	621,00 €
● F026D3GA012	621,00 €
● F026D3GA018	621,00 €
● F026D3GA030	621,00 €
● F026D3GA033	621,00 €
1-10V	
○ F026D3GB001	670,00 €
○ F026D3GB006	670,00 €
● F026D3GB012	670,00 €
● F026D3GB018	670,00 €
● F026D3GB030	670,00 €
● F026D3GB033	670,00 €
Dali	
○ F026D3GD001	670,00 €
○ F026D3GD006	670,00 €
● F026D3GD012	670,00 €
● F026D3GD018	670,00 €
● F026D3GD030	670,00 €
● F026D3GD033	670,00 €

4000K

Non Dimmable

○ F026D4GA001	621,00 €
○ F026D4GA006	621,00 €
● F026D4GA012	621,00 €
● F026D4GA018	621,00 €
● F026D4GA030	621,00 €
● F026D4GA033	621,00 €
1-10V	
○ F026D4GB001	670,00 €
○ F026D4GB006	670,00 €
● F026D4GB012	670,00 €
● F026D4GB018	670,00 €
● F026D4GB030	670,00 €
● F026D4GB033	670,00 €
Dali	
○ F026D4GD001	670,00 €
○ F026D4GD006	670,00 €
● F026D4GD012	670,00 €
● F026D4GD018	670,00 €
● F026D4GD030	670,00 €
● F026D4GD033	670,00 €

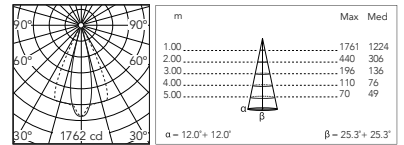

@ 3000K

Optic Wall Washer

Power Led: 10,5W - 920 lm ≠ FIXT 673 lm - 2700K/CRI 80 - 220-240V / 10,5W - 966 lm ≠ FIXT 698 lm - 3000K/CRI 80 - 220-240V / 10,5W - 1012 lm ≠ FIXT 672 lm - 4000K/CRI 80 - 220-240V

2700K

Non Dimmable

○ F026D2HA001	621,00 €
● F026D2HA006	621,00 €
● F026D2HA012	621,00 €
● F026D2HA018	621,00 €
● F026D2HA030	621,00 €
● F026D2HA033	621,00 €
1-10V	
○ F026D2HB001	670,00 €
○ F026D2HB006	670,00 €
● F026D2HB012	670,00 €
● F026D2HB018	670,00 €
● F026D2HB030	670,00 €
● F026D2HB033	670,00 €
Dali	
○ F026D2HD001	670,00 €
○ F026D2HD006	670,00 €
● F026D2HD012	670,00 €
● F026D2HD018	670,00 €
● F026D2HD030	670,00 €
● F026D2HD033	670,00 €

3000K

Non Dimmable

○ F026D3HA001	621,00 €
● F026D3HA006	621,00 €
● F026D3HA012	621,00 €
● F026D3HA018	621,00 €
● F026D3HA030	621,00 €
● F026D3HA033	621,00 €
1-10V	
○ F026D3HB001	670,00 €
○ F026D3HB006	670,00 €
● F026D3HB012	670,00 €
● F026D3HB018	670,00 €
● F026D3HB030	670,00 €
● F026D3HB033	670,00 €
Dali	
○ F026D3HD001	670,00 €
○ F026D3HD006	670,00 €
● F026D3HD012	670,00 €
● F026D3HD018	670,00 €
● F026D3HD030	670,00 €
● F026D3HD033	670,00 €

4000K

Non Dimmable

○ F026D4HA001	621,00 €
● F026D4HA006	621,00 €
● F026D4HA012	621,00 €
● F026D4HA018	621,00 €
● F026D4HA030	621,00 €
● F026D4HA033	621,00 €
1-10V	
○ F026D4HB001	670,00 €
○ F026D4HB006	670,00 €
● F026D4HB012	670,00 €
● F026D4HB018	670,00 €
● F026D4HB030	670,00 €
● F026D4HB033	670,00 €
Dali	
○ F026D4HD001	670,00 €
○ F026D4HD006	670,00 €
● F026D4HD012	670,00 €
● F026D4HD018	670,00 €
● F026D4HD030	670,00 €
● F026D4HD033	670,00 €

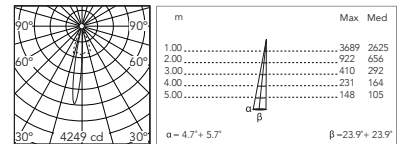

@ 3000K

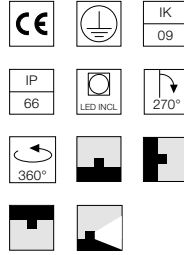
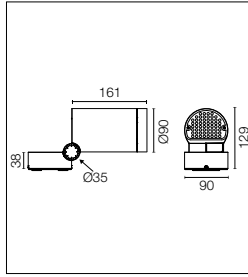

Source LED à basse consommation incluse. Équipée d'un snoot intégré pour un plus grand confort visuel. Équipée d'un snoot intégré pour un plus grand confort visuel. Les colimateurs sont des accessoires disponibles pour modifier la largeur du faisceau lumineux. Source d'alimentation électrique intégrée 220-240V ON/OFF et réglable 1-10V ou DALI. Plaque d'ancrage incluse. La connexion électrique a lieu à l'intérieur de la plaque par un connecteur étanche inclus. Pour garantir l'étanchéité, il est conseillé d'utiliser des câbles flexibles conçus pour l'installation au sol, à commander séparément.

Energy-efficient Power LED source included. Equipped with an integrated snoot for higher visual comfort. Equipped with an integrated snoot for higher visual comfort. Collimators are available as an accessory to modify the beam opening. Integrated electric power supply 220-240V ON/OFF and adjustable 1-10V or DALI. Fixing plate included. The electrical connection is made on the inside of the plate by means of a watertight connector included. To guarantee its water tightness, it is recommended to use flexible cables designed for outdoor use. Ground spike for ground installations to be ordered separately.

2200K disponible sur demande.

2200K available on request.

Optic Spot 14,5°

Power Led: 17W - 1739 lm ≠ FIXT 1443 lm - 2700K/CRI 80 - 220-240V / 17W - 1803 lm ≠ FIXT 1497 lm - 3000K/CRI 80 - 220-240V / 17W - 1868 lm ≠ FIXT 1548 lm - 4000K/CRI 80 - 220-240V

2700K

Non Dimmable

- F026E2BA001 621,00 €
- F026E2BA006 621,00 €
- F026E2BA012 621,00 €
- F026E2BA018 621,00 €
- F026E2BA030 621,00 €
- F026E2BA033 621,00 €
- 1-10V
- F026E2BB001 670,00 €
- F026E2BB006 670,00 €
- F026E2BB012 670,00 €
- F026E2BB018 670,00 €
- F026E2BB030 670,00 €
- F026E2BB033 670,00 €
- Dali
- F026E2BD001 670,00 €
- F026E2BD006 670,00 €
- F026E2BD012 670,00 €
- F026E2BD018 670,00 €
- F026E2BD030 670,00 €
- F026E2BD033 670,00 €

3000K

Non Dimmable

- F026E3BA001 621,00 €
- F026E3BA006 621,00 €
- F026E3BA012 621,00 €
- F026E3BA018 621,00 €
- F026E3BA030 621,00 €
- F026E3BA033 621,00 €
- 1-10V
- F026E3BB001 670,00 €
- F026E3BB006 670,00 €
- F026E3BB012 670,00 €
- F026E3BB018 670,00 €
- F026E3BB030 670,00 €
- F026E3BB033 670,00 €
- Dali
- F026E3BD001 670,00 €
- F026E3BD006 670,00 €
- F026E3BD012 670,00 €
- F026E3BD018 670,00 €
- F026E3BD030 670,00 €
- F026E3BD033 670,00 €

4000K

Non Dimmable

- F026E4BA001 621,00 €
- F026E4BA006 621,00 €
- F026E4BA012 621,00 €
- F026E4BA018 621,00 €
- F026E4BA030 621,00 €
- F026E4BA033 621,00 €
- 1-10V
- F026E4BB001 670,00 €
- F026E4BB006 670,00 €
- F026E4BB012 670,00 €
- F026E4BB018 670,00 €
- F026E4BB030 670,00 €
- F026E4BB033 670,00 €
- Dali
- F026E4BD001 670,00 €
- F026E4BD006 670,00 €
- F026E4BD012 670,00 €
- F026E4BD018 670,00 €
- F026E4BD030 670,00 €
- F026E4BD033 670,00 €

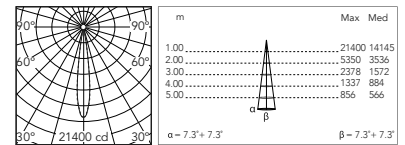

@ 3000K

Optic Medium Flood 26°

Power Led: 17W - 1739 lm ≠ FIXT 1336 lm - 2700K/CRI 80 - 220-240V / 17W - 1803 lm ≠ FIXT 1386 lm - 3000K/CRI 80 - 220-240V / 17W - 1868 lm ≠ FIXT 1434 lm - 4000K/CRI 80 - 220-240V

2700K

Non Dimmable

- F026E2CA001 621,00 €
- F026E2CA006 621,00 €
- F026E2CA012 621,00 €
- F026E2CA018 621,00 €
- F026E2CA030 621,00 €
- F026E2CA033 621,00 €
- 1-10V
- F026E2CB001 670,00 €
- F026E2CB006 670,00 €
- F026E2CB012 670,00 €
- F026E2CB018 670,00 €
- F026E2CB030 670,00 €
- F026E2CB033 670,00 €
- Dali
- F026E2CD001 670,00 €
- F026E2CD006 670,00 €
- F026E2CD012 670,00 €
- F026E2CD018 670,00 €
- F026E2CD030 670,00 €
- F026E2CD033 670,00 €

3000K

Non Dimmable

- F026E3CA001 621,00 €
- F026E3CA006 621,00 €
- F026E3CA012 621,00 €
- F026E3CA018 621,00 €
- F026E3CA030 621,00 €
- F026E3CA033 621,00 €
- 1-10V
- F026E3CB001 670,00 €
- F026E3CB006 670,00 €
- F026E3CB012 670,00 €
- F026E3CB018 670,00 €
- F026E3CB030 670,00 €
- F026E3CB033 670,00 €
- Dali
- F026E3CD001 670,00 €
- F026E3CD006 670,00 €
- F026E3CD012 670,00 €
- F026E3CD018 670,00 €
- F026E3CD030 670,00 €
- F026E3CD033 670,00 €

4000K

Non Dimmable

- F026E4CA001 621,00 €
- F026E4CA006 621,00 €
- F026E4CA012 621,00 €
- F026E4CA018 621,00 €
- F026E4CA030 621,00 €
- F026E4CA033 621,00 €
- 1-10V
- F026E4CB001 670,00 €
- F026E4CB006 670,00 €
- F026E4CB012 670,00 €
- F026E4CB018 670,00 €
- F026E4CB030 670,00 €
- F026E4CB033 670,00 €
- Dali
- F026E4CD001 670,00 €
- F026E4CD006 670,00 €
- F026E4CD012 670,00 €
- F026E4CD018 670,00 €
- F026E4CD030 670,00 €
- F026E4CD033 670,00 €

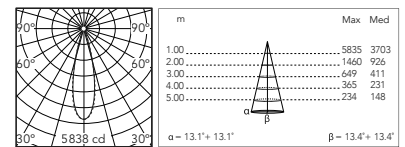

@ 3000K

Optic Flood 36°

Power Led: 17W - 1739 lm ≠ FIXT 1302 lm - 2700K/CRI 80 - 220-240V / 17W - 1803 lm ≠ FIXT 1351 lm - 3000K/CRI 80 - 220-240V / 17W - 1868 lm ≠ FIXT 1397 lm - 4000K/CRI 80 - 220-240V

2700K		3000K		4000K	
Non Dimmable		Non Dimmable		Non Dimmable	
○ F026E2DA001	621,00 €	○ F026E3DA001	621,00 €	○ F026E4DA001	621,00 €
● F026E2DA006	621,00 €	● F026E3DA006	621,00 €	● F026E4DA006	621,00 €
● F026E2DA012	621,00 €	● F026E3DA012	621,00 €	● F026E4DA012	621,00 €
● F026E2DA018	621,00 €	● F026E3DA018	621,00 €	● F026E4DA018	621,00 €
● F026E2DA030	621,00 €	● F026E3DA030	621,00 €	● F026E4DA030	621,00 €
● F026E2DA033	621,00 €	● F026E3DA033	621,00 €	● F026E4DA033	621,00 €
1-10V					
○ F026E2DB001	670,00 €	○ F026E3DB001	670,00 €	○ F026E4DB001	670,00 €
● F026E2DB006	670,00 €	● F026E3DB006	670,00 €	● F026E4DB006	670,00 €
● F026E2DB012	670,00 €	● F026E3DB012	670,00 €	● F026E4DB012	670,00 €
● F026E2DB018	670,00 €	● F026E3DB018	670,00 €	● F026E4DB018	670,00 €
● F026E2DB030	670,00 €	● F026E3DB030	670,00 €	● F026E4DB030	670,00 €
● F026E2DB033	670,00 €	● F026E3DB033	670,00 €	● F026E4DB033	670,00 €
Dali					
○ F026E2DD001	670,00 €	○ F026E3DD001	670,00 €	○ F026E4DD001	670,00 €
● F026E2DD006	670,00 €	● F026E3DD006	670,00 €	● F026E4DD006	670,00 €
● F026E2DD012	670,00 €	● F026E3DD012	670,00 €	● F026E4DD012	670,00 €
● F026E2DD018	670,00 €	● F026E3DD018	670,00 €	● F026E4DD018	670,00 €
● F026E2DD030	670,00 €	● F026E3DD030	670,00 €	● F026E4DD030	670,00 €
● F026E2DD033	670,00 €	● F026E3DD033	670,00 €	● F026E4DD033	670,00 €

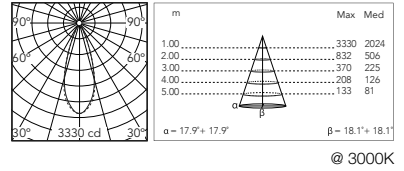

Optic Wide Flood 52°

Power Led: 17W - 1739 lm ≠ FIXT 1303 lm - 2700K/CRI 80 - 220-240V / 17W - 1803 lm ≠ FIXT 1357 lm - 3000K/CRI 80 - 220-240V / 17W - 1868 lm ≠ FIXT 1411 lm - 4000K/CRI 80 - 220-240V

2700K		3000K		4000K	
Non Dimmable		Non Dimmable		Non Dimmable	
○ F026E2EA001	621,00 €	○ F026E3EA001	621,00 €	○ F026E4EA001	621,00 €
● F026E2EA006	621,00 €	● F026E3EA006	621,00 €	● F026E4EA006	621,00 €
● F026E2EA012	621,00 €	● F026E3EA012	621,00 €	● F026E4EA012	621,00 €
● F026E2EA018	621,00 €	● F026E3EA018	621,00 €	● F026E4EA018	621,00 €
● F026E2EA030	621,00 €	● F026E3EA030	621,00 €	● F026E4EA030	621,00 €
● F026E2EA033	621,00 €	● F026E3EA033	621,00 €	● F026E4EA033	621,00 €
1-10V					
○ F026E2EB001	670,00 €	○ F026E3EB001	670,00 €	○ F026E4EB001	670,00 €
● F026E2EB006	670,00 €	● F026E3EB006	670,00 €	● F026E4EB006	670,00 €
● F026E2EB012	670,00 €	● F026E3EB012	670,00 €	● F026E4EB012	670,00 €
● F026E2EB018	670,00 €	● F026E3EB018	670,00 €	● F026E4EB018	670,00 €
● F026E2EB030	670,00 €	● F026E3EB030	670,00 €	● F026E4EB030	670,00 €
● F026E2EB033	670,00 €	● F026E3EB033	670,00 €	● F026E4EB033	670,00 €
Dali					
○ F026E2ED001	670,00 €	○ F026E3ED001	670,00 €	○ F026E4ED001	670,00 €
● F026E2ED006	670,00 €	● F026E3ED006	670,00 €	● F026E4ED006	670,00 €
● F026E2ED012	670,00 €	● F026E3ED012	670,00 €	● F026E4ED012	670,00 €
● F026E2ED018	670,00 €	● F026E3ED018	670,00 €	● F026E4ED018	670,00 €
● F026E2ED030	670,00 €	● F026E3ED030	670,00 €	● F026E4ED030	670,00 €
● F026E2ED033	670,00 €	● F026E3ED033	670,00 €	● F026E4ED033	670,00 €

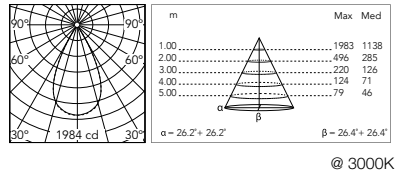

Optic Elliptical 1 14° x 50°

Power Led: 17W - 1739 lm ≠ FIXT 1315 lm - 2700K/CRI 80 - 220-240V / 17W - 1803 lm ≠ FIXT 1364 lm - 3000K/CRI 80 - 220-240V / 17W - 1868 lm ≠ FIXT 1410 lm - 4000K/CRI 80 - 220-240V

2700K		3000K		4000K	
Non Dimmable		Non Dimmable		Non Dimmable	
○ F026E2FA001	621,00 €	○ F026E3FA001	621,00 €	○ F026E4FA001	621,00 €
● F026E2FA006	621,00 €	● F026E3FA006	621,00 €	● F026E4FA006	621,00 €
● F026E2FA012	621,00 €	● F026E3FA012	621,00 €	● F026E4FA012	621,00 €
● F026E2FA018	621,00 €	● F026E3FA018	621,00 €	● F026E4FA018	621,00 €
● F026E2FA030	621,00 €	● F026E3FA030	621,00 €	● F026E4FA030	621,00 €
● F026E2FA033	621,00 €	● F026E3FA033	621,00 €	● F026E4FA033	621,00 €
1-10V					
○ F026E2FB001	670,00 €	○ F026E3FB001	670,00 €	○ F026E4FB001	670,00 €
● F026E2FB006	670,00 €	● F026E3FB006	670,00 €	● F026E4FB006	670,00 €
● F026E2FB012	670,00 €	● F026E3FB012	670,00 €	● F026E4FB012	670,00 €
● F026E2FB018	670,00 €	● F026E3FB018	670,00 €	● F026E4FB018	670,00 €
● F026E2FB030	670,00 €	● F026E3FB030	670,00 €	● F026E4FB030	670,00 €
● F026E2FB033	670,00 €	● F026E3FB033	670,00 €	● F026E4FB033	670,00 €
Dali					
○ F026E2FD001	670,00 €	○ F026E3FD001	670,00 €	○ F026E4FD001	670,00 €
● F026E2FD006	670,00 €	● F026E3FD006	670,00 €	● F026E4FD006	670,00 €
● F026E2FD012	670,00 €	● F026E3FD012	670,00 €	● F026E4FD012	670,00 €
● F026E2FD018	670,00 €	● F026E3FD018	670,00 €	● F026E4FD018	670,00 €
● F026E2FD030	670,00 €	● F026E3FD030	670,00 €	● F026E4FD030	670,00 €
● F026E2FD033	670,00 €	● F026E3FD033	670,00 €	● F026E4FD033	670,00 €

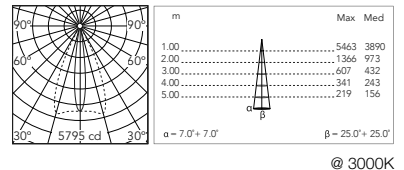

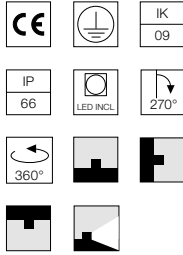
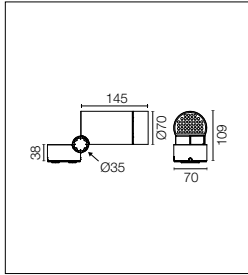

Source Power LED incluse. Équipée d'un snoot intégré pour un plus grand confort visuel: viseur asymétrique disponible en tant qu'accessoire. Les collimateurs sont des accessoires disponibles pour modifier la largeur du faisceau lumineux. Source d'alimentation électrique intégrée 220-240V ON/OFF. Plaque d'ancrage incluse. La connexion électrique a lieu à l'intérieur de la plaque par un connecteur étanche inclus. Pour garantir l'étanchéité, il est conseillé d'utiliser des câbles flexibles conçus pour l'extérieur. Clou métallique pour l'installation au sol, à commander séparément. Sur commande, version réglable 1-10V ou DALI avec source d'alimentation à distance 24Vdc.

Power LED source included. Equipped with an integrated snoot for higher visual comfort: the asymmetrical cut visor is available as an accessory. Collimators are available as an accessory to modify the beam opening. Integrated electric power supply 220-240V ON/OFF. Fixing plate included. The electrical connection is made on the inside of the plate by means of a watertight connector included. To guarantee its water tightness, it is recommended to use flexible cables designed for outdoor use. Ground spike for ground installations to be ordered separately. Upon request: 1-10V or DALI dimmable version with 24Vdc remote power supply.

2200K disponible sur demande.

2200K available on request.

Optic Narrow Spot 7°

Power Led: 3,5W - 168 lm ≠ FIXT 143 lm - 2700K/CRI 80 - 220-240V / 3,5W - 174 lm ≠ FIXT 149 lm - 3000K/CRI 80 - 220-240V / 3,5W - 180 lm ≠ FIXT 154 lm - 4000K/CRI 80 - 220-240V

2700K

Non Dimmable

○ F025B2AA001	533,00 €
● F025B2AA006	533,00 €
● F025B2AA012	533,00 €
● F025B2AA018	533,00 €
● F025B2AA030	533,00 €
● F025B2AA033	533,00 €

3000K

Non Dimmable

○ F025B3AA001	533,00 €
● F025B3AA006	533,00 €
● F025B3AA012	533,00 €
● F025B3AA018	533,00 €
● F025B3AA030	533,00 €
● F025B3AA033	533,00 €

4000K

Non Dimmable

○ F025B4AA001	533,00 €
● F025B4AA006	533,00 €
● F025B4AA012	533,00 €
● F025B4AA018	533,00 €
● F025B4AA030	533,00 €
● F025B4AA033	533,00 €

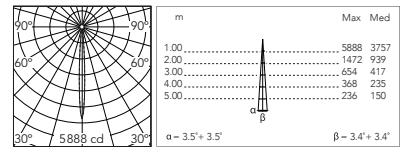

@ 3000K

Optic Spot 14°

Power Led: 7,9W - 671 lm ≠ FIXT 550 lm - 2700K/CRI 80 - 220-240V / 7,9W - 696 lm ≠ FIXT 571 lm - 3000K/CRI 80 - 220-240V / 7,9W - 720 lm ≠ FIXT 591 lm - 4000K/CRI 80 - 220-240V

2700K

Non Dimmable

○ F025B2BA001	533,00 €
● F025B2BA006	533,00 €
● F025B2BA012	533,00 €
● F025B2BA018	533,00 €
● F025B2BA030	533,00 €
● F025B2BA033	533,00 €

3000K

Non Dimmable

○ F025B3BA001	533,00 €
● F025B3BA006	533,00 €
● F025B3BA012	533,00 €
● F025B3BA018	533,00 €
● F025B3BA030	533,00 €
● F025B3BA033	533,00 €

4000K

Non Dimmable

○ F025B4BA001	533,00 €
● F025B4BA006	533,00 €
● F025B4BA012	533,00 €
● F025B4BA018	533,00 €
● F025B4BA030	533,00 €
● F025B4BA033	533,00 €

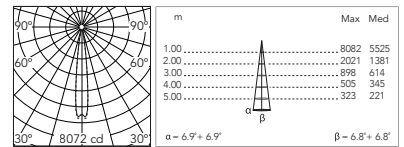

@ 3000K

Optic Medium Flood 24,5°

Power Led: 7,9W - 671 lm ≠ FIXT 499 lm - 2700K/CRI 80 - 220-240V / 7,9W - 696 lm ≠ FIXT 518 lm - 3000K/CRI 80 - 220-240V / 7,9W - 720 lm ≠ FIXT 536 lm - 4000K/CRI 80 - 220-240V

2700K

Non Dimmable

○ F025B2CA001	533,00 €
● F025B2CA006	533,00 €
● F025B2CA012	533,00 €
● F025B2CA018	533,00 €
● F025B2CA030	533,00 €
● F025B2CA033	533,00 €

3000K

Non Dimmable

○ F025B3CA001	533,00 €
● F025B3CA006	533,00 €
● F025B3CA012	533,00 €
● F025B3CA018	533,00 €
● F025B3CA030	533,00 €
● F025B3CA033	533,00 €

4000K

Non Dimmable

○ F025B4CA001	533,00 €
● F025B4CA006	533,00 €
● F025B4CA012	533,00 €
● F025B4CA018	533,00 €
● F025B4CA030	533,00 €
● F025B4CA033	533,00 €

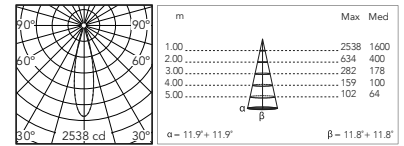

@ 3000K

Optic Flood 32°

Power Led: 7,9W - 671 lm ≠ FIXT 482 lm - 2700K/CRI 80 - 220-240V / 7,9W - 696 lm ≠ FIXT 500 lm - 3000K/CRI 80 - 220-240V / 7,9W - 720 lm ≠ FIXT 518 lm - 4000K/CRI 80 - 220-240V

2700K

Non Dimmable

○ F025B2DA001	533,00 €
● F025B2DA006	533,00 €
● F025B2DA012	533,00 €
● F025B2DA018	533,00 €
● F025B2DA030	533,00 €
● F025B2DA033	533,00 €

3000K

Non Dimmable

○ F025B3DA001	533,00 €
● F025B3DA006	533,00 €
● F025B3DA012	533,00 €
● F025B3DA018	533,00 €
● F025B3DA030	533,00 €
● F025B3DA033	533,00 €

4000K

Non Dimmable

○ F025B4DA001	533,00 €
● F025B4DA006	533,00 €
● F025B4DA012	533,00 €
● F025B4DA018	533,00 €
● F025B4DA030	533,00 €
● F025B4DA033	533,00 €

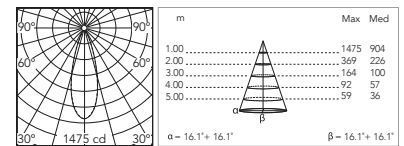

@ 3000K

Spine 1 Ultra

Optic Wide Flood 49°

Power Led: 7,9W - 671 lm ≠ FIXT 480 lm - 2700K/CRI 80 - 220-240V / 7,9W - 696 lm ≠ FIXT 490 lm - 3000K/CRI 80 - 220-240V / 7,9W - 720 lm ≠ FIXT 505 lm - 4000K/CRI 80 - 220-240V

2700K		3000K		4000K	
Non Dimmable		Non Dimmable		Non Dimmable	
○ F025B2EA001	533,00 €	○ F025B3EA001	533,00 €	○ F025B4EA001	533,00 €
● F025B2EA006	533,00 €	● F025B3EA006	533,00 €	● F025B4EA006	533,00 €
● F025B2EA012	533,00 €	● F025B3EA012	533,00 €	● F025B4EA012	533,00 €
● F025B2EA018	533,00 €	● F025B3EA018	533,00 €	● F025B4EA018	533,00 €
● F025B2EA030	533,00 €	● F025B3EA030	533,00 €	● F025B4EA030	533,00 €
● F025B2EA033	533,00 €	● F025B3EA033	533,00 €	● F025B4EA033	533,00 €

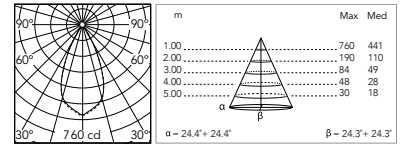

@ 3000K

Optic Elliptical 1 13,5° x 50°

Power Led: 7,9W - 671 lm ≠ FIXT 500 lm - 2700K/CRI 80 - 220-240V / 7,9W - 696 lm ≠ FIXT 519 lm - 3000K/CRI 80 - 220-240V / 7,9W - 720 lm ≠ FIXT 537 lm - 4000K/CRI 80 - 220-240V

2700K		3000K		4000K	
Non Dimmable		Non Dimmable		Non Dimmable	
○ F025B2FA001	533,00 €	○ F025B3FA001	533,00 €	○ F025B4FA001	533,00 €
● F025B2FA006	533,00 €	● F025B3FA006	533,00 €	● F025B4FA006	533,00 €
● F025B2FA012	533,00 €	● F025B3FA012	533,00 €	● F025B4FA012	533,00 €
● F025B2FA018	533,00 €	● F025B3FA018	533,00 €	● F025B4FA018	533,00 €
● F025B2FA030	533,00 €	● F025B3FA030	533,00 €	● F025B4FA030	533,00 €
● F025B2FA033	533,00 €	● F025B3FA033	533,00 €	● F025B4FA033	533,00 €

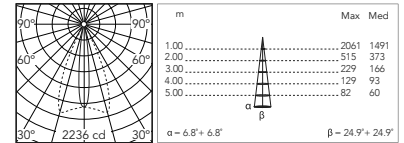

@ 3000K

Optic Elliptical 2 26° x 51°

Power Led: 7,9W - 671 lm ≠ FIXT 487 lm - 2700K/CRI 80 - 220-240V / 7,9W - 696 lm ≠ FIXT 505 lm - 3000K/CRI 80 - 220-240V / 7,9W - 720 lm ≠ FIXT 523 lm - 4000K/CRI 80 - 220-240V

2700K		3000K		4000K	
Non Dimmable		Non Dimmable		Non Dimmable	
○ F025B2GA001	533,00 €	○ F025B3GA001	533,00 €	○ F025B4GA001	533,00 €
● F025B2GA006	533,00 €	● F025B3GA006	533,00 €	● F025B4GA006	533,00 €
● F025B2GA012	533,00 €	● F025B3GA012	533,00 €	● F025B4GA012	533,00 €
● F025B2GA018	533,00 €	● F025B3GA018	533,00 €	● F025B4GA018	533,00 €
● F025B2GA030	533,00 €	● F025B3GA030	533,00 €	● F025B4GA030	533,00 €
● F025B2GA033	533,00 €	● F025B3GA033	533,00 €	● F025B4GA033	533,00 €

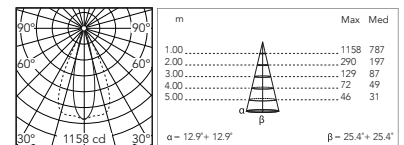

@ 3000K

Optic Wall Washer

Power Led: 7,9W - 671 lm ≠ FIXT 471 lm - 2700K/CRI 80 - 220-240V / 7,9W - 696 lm ≠ FIXT 489 lm - 3000K/CRI 80 - 220-240V / 7,9W - 720 lm ≠ FIXT 506 lm - 4000K/CRI 80 - 220-240V

2700K		3000K		4000K	
Non Dimmable		Non Dimmable		Non Dimmable	
○ F025B2HA001	533,00 €	○ F025B3HA001	533,00 €	○ F025B4HA001	533,00 €
● F025B2HA006	533,00 €	● F025B3HA006	533,00 €	● F025B4HA006	533,00 €
● F025B2HA012	533,00 €	● F025B3HA012	533,00 €	● F025B4HA012	533,00 €
● F025B2HA018	533,00 €	● F025B3HA018	533,00 €	● F025B4HA018	533,00 €
● F025B2HA030	533,00 €	● F025B3HA030	533,00 €	● F025B4HA030	533,00 €
● F025B2HA033	533,00 €	● F025B3HA033	533,00 €	● F025B4HA033	533,00 €

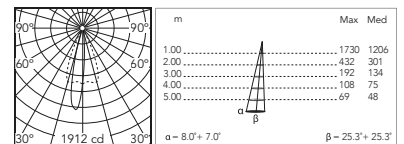

@ 3000K

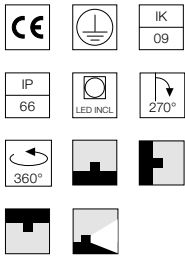
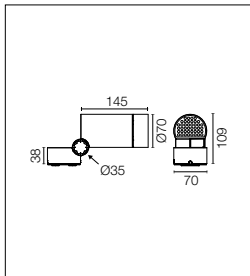

Source LED à basse consommation incluse. Équipée d'un snoot intégré pour un plus grand confort visuel: viseur asymétrique disponible en tant qu'accessoire. Les collimateurs sont des accessoires disponibles pour modifier la largeur du faisceau lumineux. Source d'alimentation électrique intégrée 220-240V ON/OFF. Plaque d'ancrage incluse. La connexion électrique a lieu à l'intérieur de la plaque par un connecteur étanche inclus. Pour garantir l'étanchéité, il est conseillé d'utiliser des câbles flexibles conçus pour l'extérieur. Clou métallique pour l'installation au sol, à commander séparément. Sur commande, version réglable 1-10V ou DALI avec source d'alimentation à distance 24Vdc.

Energy-efficient Power LED source included Equipped with an integrated snoot for higher visual comfort: the asymmetrical cut visor is available as an accessory. Collimators are available as an accessory to modify the beam opening. Integrated electric power supply 220-240V ON/OFF. Fixing plate included. The electrical connection is made on the inside of the plate by means of a watertight connector included. To guarantee its water tightness, it is recommended to use flexible cables designed for outdoor use. Ground spike for ground installations to be ordered separately. Upon request: 1-10V or DALI dimmable version with 24Vdc remote power supply.

Optic Spot 12°

Power Led: 10,5W - 920 lm ≠ FIXT 680 lm - 2700K/CRI 80 - 220-240V / 10,5W - 966 lm ≠ FIXT 706 lm - 3000K/CRI 80 - 220-240V / 10,5W - 1012 lm ≠ FIXT 730 lm - 4000K/CRI 80 - 220-240V

2700K

Non Dimmable

○ F025C2BA001	533,00 €
● F025C2BA006	533,00 €
● F025C2BA012	533,00 €
● F025C2BA018	533,00 €
● F025C2BA030	533,00 €
● F025C2BA033	533,00 €

3000K

Non Dimmable

○ F025C3BA001	533,00 €
● F025C3BA006	533,00 €
● F025C3BA012	533,00 €
● F025C3BA018	533,00 €
● F025C3BA030	533,00 €
● F025C3BA033	533,00 €

4000K

Non Dimmable

○ F025C4BA001	533,00 €
● F025C4BA006	533,00 €
● F025C4BA012	533,00 €
● F025C4BA018	533,00 €
● F025C4BA030	533,00 €
● F025C4BA033	533,00 €

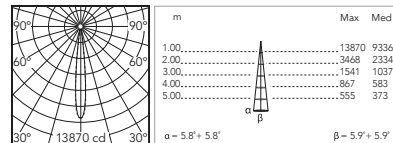

@ 3000K

Optic Medium Flood 26,5°

Power Led: 10,5W - 920 lm ≠ FIXT 594 lm - 2700K/CRI 80 - 220-240V / 10,5W - 966 lm ≠ FIXT 630 lm - 3000K/CRI 80 - 220-240V / 10,5W - 1012 lm ≠ FIXT 654 lm - 4000K/CRI 80 - 220-240V

2700K

Non Dimmable

○ F025C2CA001	533,00 €
● F025C2CA006	533,00 €
● F025C2CA012	533,00 €
● F025C2CA018	533,00 €
● F025C2CA030	533,00 €
● F025C2CA033	533,00 €

3000K

Non Dimmable

○ F025C3CA001	533,00 €
● F025C3CA006	533,00 €
● F025C3CA012	533,00 €
● F025C3CA018	533,00 €
● F025C3CA030	533,00 €
● F025C3CA033	533,00 €

4000K

Non Dimmable

○ F025C4CA001	533,00 €
● F025C4CA006	533,00 €
● F025C4CA012	533,00 €
● F025C4CA018	533,00 €
● F025C4CA030	533,00 €
● F025C4CA033	533,00 €

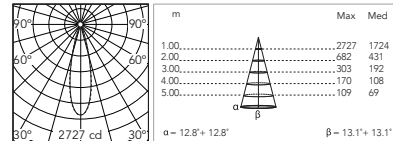

@ 3000K

Optic Flood 33,5°

Power Led: 10,5W - 920 lm ≠ FIXT 592 lm - 2700K/CRI 80 - 220-240V / 10,5W - 966 lm ≠ FIXT 627 lm - 3000K/CRI 80 - 220-240V / 10,5W - 1012 lm ≠ FIXT 651 lm - 4000K/CRI 80 - 220-240V

2700K

Non Dimmable

○ F025C2DA001	533,00 €
● F025C2DA006	533,00 €
● F025C2DA012	533,00 €
● F025C2DA018	533,00 €
● F025C2DA030	533,00 €
● F025C2DA033	533,00 €

3000K

Non Dimmable

○ F025C3DA001	533,00 €
● F025C3DA006	533,00 €
● F025C3DA012	533,00 €
● F025C3DA018	533,00 €
● F025C3DA030	533,00 €
● F025C3DA033	533,00 €

4000K

Non Dimmable

○ F025C4DA001	533,00 €
● F025C4DA006	533,00 €
● F025C4DA012	533,00 €
● F025C4DA018	533,00 €
● F025C4DA030	533,00 €
● F025C4DA033	533,00 €

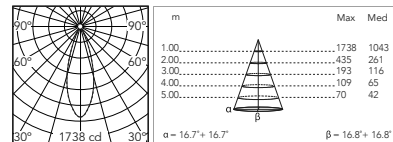

@ 3000K

Optic Wide Flood 50°

Power Led: 10,5W - 920 lm ≠ FIXT 591 lm - 2700K/CRI 80 - 220-240V / 10,5W - 966 lm ≠ FIXT 619 lm - 3000K/CRI 80 - 220-240V / 10,5W - 1012 lm ≠ FIXT 650 lm - 4000K/CRI 80 - 220-240V

2700K

Non Dimmable

○ F025C2EA001	533,00 €
● F025C2EA006	533,00 €
● F025C2EA012	533,00 €
● F025C2EA018	533,00 €
● F025C2EA030	533,00 €
● F025C2EA033	533,00 €

3000K

Non Dimmable

○ F025C3EA001	533,00 €
● F025C3EA006	533,00 €
● F025C3EA012	533,00 €
● F025C3EA018	533,00 €
● F025C3EA030	533,00 €
● F025C3EA033	533,00 €

4000K

Non Dimmable

○ F025C4EA001	533,00 €
● F025C4EA006	533,00 €
● F025C4EA012	533,00 €
● F025C4EA018	533,00 €
● F025C4EA030	533,00 €
● F025C4EA033	533,00 €

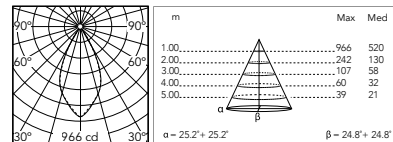

@ 3000K

Spine 1 Ultra Hp

Optic Elliptical 1 11,5° x 49°

Power Led: 10,5W - 920 lm ≠ FIXT 603 lm - 2700K/CRI 80 - 220-240V / 10,5W - 966 lm ≠ FIXT 639 lm - 3000K/CRI 80 - 220-240V / 10,5W - 1012 lm ≠ FIXT 663 lm - 4000K/CRI 80 - 220-240V

2700K

Non Dimmable

○ F025C2FA001	533,00 €
● F025C2FA006	533,00 €
● F025C2FA012	533,00 €
● F025C2FA018	533,00 €
● F025C2FA030	533,00 €
● F025C2FA033	533,00 €

3000K

Non Dimmable

○ F025C3FA001	533,00 €
● F025C3FA006	533,00 €
● F025C3FA012	533,00 €
● F025C3FA018	533,00 €
● F025C3FA030	533,00 €
● F025C3FA033	533,00 €

4000K

Non Dimmable

○ F025C4FA001	533,00 €
● F025C4FA006	533,00 €
● F025C4FA012	533,00 €
● F025C4FA018	533,00 €
● F025C4FA030	533,00 €
● F025C4FA033	533,00 €

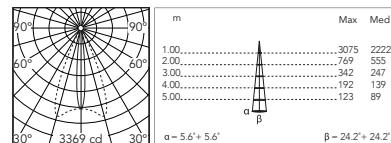

@ 3000K

Optic Elliptical 2 25,5° x 50°

Power Led: 10,5W - 920 lm ≠ FIXT 601 lm - 2700K/CRI 80 - 220-240V / 10,5W - 966 lm ≠ FIXT 624 lm - 3000K/CRI 80 - 220-240V / 10,5W - 1012 lm ≠ FIXT 645 lm - 4000K/CRI 80 - 220-240V

2700K

Non Dimmable

○ F025C2GA001	533,00 €
● F025C2GA006	533,00 €
● F025C2GA012	533,00 €
● F025C2GA018	533,00 €
● F025C2GA030	533,00 €
● F025C2GA033	533,00 €

3000K

Non Dimmable

○ F025C3GA001	533,00 €
● F025C3GA006	533,00 €
● F025C3GA012	533,00 €
● F025C3GA018	533,00 €
● F025C3GA030	533,00 €
● F025C3GA033	533,00 €

4000K

Non Dimmable

○ F025C4GA001	533,00 €
● F025C4GA006	533,00 €
● F025C4GA012	533,00 €
● F025C4GA018	533,00 €
● F025C4GA030	533,00 €
● F025C4GA033	533,00 €

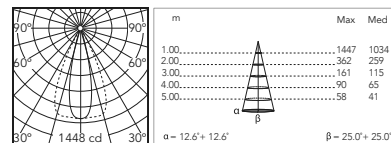

@ 3000K

Optic Wall Washer

Power Led: 10,5W - 920 lm ≠ FIXT 574 lm - 2700K/CRI 80 - 220-240V / 10,5W - 966 lm ≠ FIXT 609 lm - 3000K/CRI 80 - 220-240V / 10,5W - 1012 lm ≠ FIXT 631 lm - 4000K/CRI 80 - 220-240V

2700K

Non Dimmable

○ F025C2HA001	533,00 €
● F025C2HA006	533,00 €
● F025C2HA012	533,00 €
● F025C2HA018	533,00 €
● F025C2HA030	533,00 €
● F025C2HA033	533,00 €

3000K

Non Dimmable

○ F025C3HA001	533,00 €
● F025C3HA006	533,00 €
● F025C3HA012	533,00 €
● F025C3HA018	533,00 €
● F025C3HA030	533,00 €
● F025C3HA033	533,00 €

4000K

Non Dimmable

○ F025C4HA001	533,00 €
● F025C4HA006	533,00 €
● F025C4HA012	533,00 €
● F025C4HA018	533,00 €
● F025C4HA030	533,00 €
● F025C4HA033	533,00 €

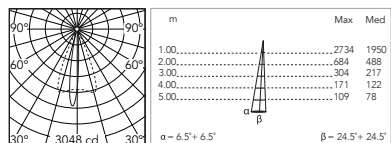

@ 3000K

Spine 1 Ultra: Accessoires / Accessories

Visueur	Visor	○ F025Z050001	50,00 €	
		● F025Z050006	50,00 €	
		● F025Z050012	50,00 €	
		● F025Z050018	50,00 €	
		● F025Z050030	50,00 €	
		● F025Z050033	50,00 €	

Pique de terre.	Ground spike.	F026Z010000	27,00 €	
-----------------	---------------	-------------	---------	--

Honeycomb	Honeycomb Louvre	F025Z060000	20,00 €	
-----------	------------------	-------------	---------	--

Lentilles de conversion / Converter lenses:

- Converter Spine 0 / Spine 1 Optic Medium Flood	F029Z010000	35,00 €	
- Converter Spine 0 / Spine 1 Optic Flood	F029Z011000	35,00 €	
- Converter Spine 0 / Spine 1 Optic Wide Flood	F029Z012000	35,00 €	
- Converter Spine 0 / Spine 1 Optic Elliptic 1	F029Z013000	35,00 €	
- Converter Spine 0 / Spine 1 Optic Elliptic 2	F029Z014000	35,00 €	
- Converter Spine 0 / Spine 1 Optic Wall Washer	F029Z015000	35,00 €	

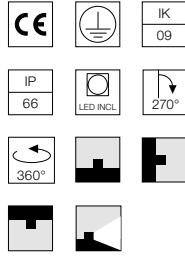
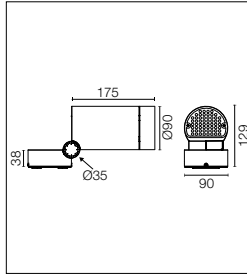

Source LED incluse. Équipée d'un snoot intégré pour un plus grand confort visuel: viseur asymétrique disponible en tant qu'accessoire. Les collimateurs sont des accessoires disponibles pour modifier la largeur du faisceau lumineux. Source d'alimentation électrique intégrée 220-240V ON/OFF et réglable 1-10V ou DALI. Plaque d'ancrage incluse. La connexion électrique a lieu à l'intérieur de la plaque par un connecteur étanche inclus. Pour garantir l'étanchéité, il est conseillé d'utiliser des câbles flexibles conçus pour l'extérieur. Clou métallique pour l'installation au sol, à commander séparément.

Power LED source included. Equipped with an integrated snoot for higher visual comfort: the asymmetrical cut visor is available as an accessory. Collimators are available as an accessory to modify the beam opening. Integrated electric power supply 220-240V ON/OFF and adjustable 1-10V or DALI. Fixing plate included. The electrical connection is made on the inside of the plate by means of a watertight connector included. To guarantee its water tightness, it is recommended to use flexible cables designed for outdoor use. Ground spike for ground installations to be ordered separately.

Optic Narrow Spot
2200K disponible sur demande.

Optic Narrow Spot
2200K available on request.

Optic Narrow Spot 6°

Power Led: 4,1W - 248 lm ≠ FIXT 230 lm - 2700K/CRI 80 - 220-240V / 4,1W - 258 lm ≠ FIXT 239 lm - 3000K/CRI 80 - 220-240V / 4,1W - 267 lm ≠ FIXT 247 lm - 4000K/CRI 80 - 220-240V

2700K

Non Dimmable

- F026B2AA001 637,00 €
- F026B2AA006 637,00 €
- F026B2AA012 637,00 €
- F026B2AA018 637,00 €
- F026B2AA030 637,00 €
- F026B2AA033 637,00 €
- 1-10V
- F026B2AB001 689,00 €
- F026B2AB006 689,00 €
- F026B2AB012 689,00 €
- F026B2AB018 689,00 €
- F026B2AB030 689,00 €
- F026B2AB033 689,00 €
- Dali
- F026B2AD001 689,00 €
- F026B2AD006 689,00 €
- F026B2AD012 689,00 €
- F026B2AD018 689,00 €
- F026B2AD030 689,00 €
- F026B2AD033 689,00 €

3000K

Non Dimmable

- F026B3AA001 637,00 €
- F026B3AA006 637,00 €
- F026B3AA012 637,00 €
- F026B3AA018 637,00 €
- F026B3AA030 637,00 €
- F026B3AA033 637,00 €
- 1-10V
- F026B3AB001 689,00 €
- F026B3AB006 689,00 €
- F026B3AB012 689,00 €
- F026B3AB018 689,00 €
- F026B3AB030 689,00 €
- F026B3AB033 689,00 €
- Dali
- F026B3AD001 689,00 €
- F026B3AD006 689,00 €
- F026B3AD012 689,00 €
- F026B3AD018 689,00 €
- F026B3AD030 689,00 €
- F026B3AD033 689,00 €

4000K

Non Dimmable

- F026B4AA001 637,00 €
- F026B4AA006 637,00 €
- F026B4AA012 637,00 €
- F026B4AA018 637,00 €
- F026B4AA030 637,00 €
- F026B4AA033 637,00 €
- 1-10V
- F026B4AB001 689,00 €
- F026B4AB006 689,00 €
- F026B4AB012 689,00 €
- F026B4AB018 689,00 €
- F026B4AB030 689,00 €
- F026B4AB033 689,00 €
- Dali
- F026B4AD001 689,00 €
- F026B4AD006 689,00 €
- F026B4AD012 689,00 €
- F026B4AD018 689,00 €
- F026B4AD030 689,00 €
- F026B4AD033 689,00 €

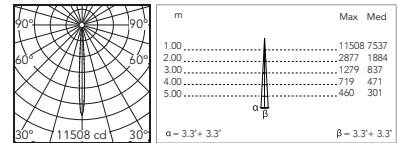

@ 3000K

Optic Spot 9,5°

Power Led: 10,5W - 920 lm ≠ FIXT 769 lm - 2700K/CRI 80 - 220-240V / 10,5W - 966 lm ≠ FIXT 808 lm - 3000K/CRI 80 - 220-240V / 10,5W - 1012 lm ≠ FIXT 846 lm - 4000K/CRI 80 - 220-240V

2700K

Non Dimmable

- F026B2BA001 637,00 €
- F026B2BA006 637,00 €
- F026B2BA012 637,00 €
- F026B2BA018 637,00 €
- F026B2BA030 637,00 €
- F026B2BA033 637,00 €
- 1-10V
- F026B2BB001 689,00 €
- F026B2BB006 689,00 €
- F026B2BB012 689,00 €
- F026B2BB018 689,00 €
- F026B2BB030 689,00 €
- F026B2BB033 689,00 €
- Dali
- F026B2BD001 689,00 €
- F026B2BD006 689,00 €
- F026B2BD012 689,00 €
- F026B2BD018 689,00 €
- F026B2BD030 689,00 €
- F026B2BD033 689,00 €

3000K

Non Dimmable

- F026B3BA001 637,00 €
- F026B3BA006 637,00 €
- F026B3BA012 637,00 €
- F026B3BA018 637,00 €
- F026B3BA030 637,00 €
- F026B3BA033 637,00 €
- 1-10V
- F026B3BB001 689,00 €
- F026B3BB006 689,00 €
- F026B3BB012 689,00 €
- F026B3BB018 689,00 €
- F026B3BB030 689,00 €
- F026B3BB033 689,00 €
- Dali
- F026B3BD001 689,00 €
- F026B3BD006 689,00 €
- F026B3BD012 689,00 €
- F026B3BD018 689,00 €
- F026B3BD030 689,00 €
- F026B3BD033 689,00 €

4000K

Non Dimmable

- F026B4BA001 637,00 €
- F026B4BA006 637,00 €
- F026B4BA012 637,00 €
- F026B4BA018 637,00 €
- F026B4BA030 637,00 €
- F026B4BA033 637,00 €
- 1-10V
- F026B4BB001 689,00 €
- F026B4BB006 689,00 €
- F026B4BB012 689,00 €
- F026B4BB018 689,00 €
- F026B4BB030 689,00 €
- F026B4BB033 689,00 €
- Dali
- F026B4BD001 689,00 €
- F026B4BD006 689,00 €
- F026B4BD012 689,00 €
- F026B4BD018 689,00 €
- F026B4BD030 689,00 €
- F026B4BD033 689,00 €

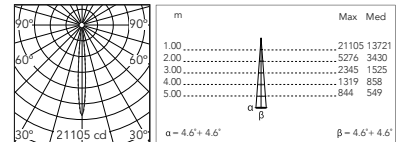

@ 3000K

Spine 2 Ultra

Optic Elliptical 1 9,5° x 48°

Power Led: 10,5W - 920 lm ≠ FIXT 717 lm - 2700K/CRI 80 - 220-240V / 10,5W - 966 lm ≠ FIXT 744 lm - 3000K/CRI 80 - 220-240V / 10,5W - 1012 lm ≠ FIXT 770 lm - 4000K/CRI 80 - 220-240V

2700K		3000K		4000K	
Non Dimmable		Non Dimmable		Non Dimmable	
○ F026B2FA001	637,00 €	○ F026B3FA001	637,00 €	○ F026B4FA001	637,00 €
● F026B2FA006	637,00 €	● F026B3FA006	637,00 €	● F026B4FA006	637,00 €
● F026B2FA012	637,00 €	● F026B3FA012	637,00 €	● F026B4FA012	637,00 €
● F026B2FA018	637,00 €	● F026B3FA018	637,00 €	● F026B4FA018	637,00 €
● F026B2FA030	637,00 €	● F026B3FA030	637,00 €	● F026B4FA030	637,00 €
● F026B2FA033	637,00 €	● F026B3FA033	637,00 €	● F026B4FA033	637,00 €
1-10V					
○ F026B2FB001	689,00 €	○ F026B3FB001	689,00 €	○ F026B4FB001	689,00 €
● F026B2FB006	689,00 €	● F026B3FB006	689,00 €	● F026B4FB006	689,00 €
● F026B2FB012	689,00 €	● F026B3FB012	689,00 €	● F026B4FB012	689,00 €
● F026B2FB018	689,00 €	● F026B3FB018	689,00 €	● F026B4FB018	689,00 €
● F026B2FB030	689,00 €	● F026B3FB030	689,00 €	● F026B4FB030	689,00 €
● F026B2FB033	689,00 €	● F026B3FB033	689,00 €	● F026B4FB033	689,00 €
Dali					
○ F026B2FD001	689,00 €	○ F026B3FD001	689,00 €	○ F026B4FD001	689,00 €
● F026B2FD006	689,00 €	● F026B3FD006	689,00 €	● F026B4FD006	689,00 €
● F026B2FD012	689,00 €	● F026B3FD012	689,00 €	● F026B4FD012	689,00 €
● F026B2FD018	689,00 €	● F026B3FD018	689,00 €	● F026B4FD018	689,00 €
● F026B2FD030	689,00 €	● F026B3FD030	689,00 €	● F026B4FD030	689,00 €
● F026B2FD033	689,00 €	● F026B3FD033	689,00 €	● F026B4FD033	689,00 €

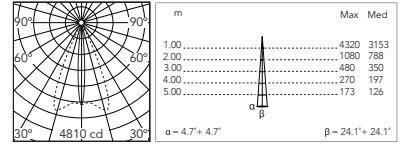

@ 3000K

Optic Elliptical 2 24° x 50°

Power Led: 10,5W - 920 lm ≠ FIXT 699 lm - 2700K/CRI 80 - 220-240V / 10,5W - 966 lm ≠ FIXT 725 lm - 3000K/CRI 80 - 220-240V / 10,5W - 1012 lm ≠ FIXT 750 lm - 4000K/CRI 80 - 220-240V

2700K		3000K		4000K	
Non Dimmable		Non Dimmable		Non Dimmable	
○ F026B2GA001	637,00 €	○ F026B3GA001	637,00 €	○ F026B4GA001	637,00 €
● F026B2GA006	637,00 €	● F026B3GA006	637,00 €	● F026B4GA006	637,00 €
● F026B2GA012	637,00 €	● F026B3GA012	637,00 €	● F026B4GA012	637,00 €
● F026B2GA018	637,00 €	● F026B3GA018	637,00 €	● F026B4GA018	637,00 €
● F026B2GA030	637,00 €	● F026B3GA030	637,00 €	● F026B4GA030	637,00 €
● F026B2GA033	637,00 €	● F026B3GA033	637,00 €	● F026B4GA033	637,00 €
1-10V					
○ F026B2GB001	689,00 €	○ F026B3GB001	689,00 €	○ F026B4GB001	689,00 €
● F026B2GB006	689,00 €	● F026B3GB006	689,00 €	● F026B4GB006	689,00 €
● F026B2GB012	689,00 €	● F026B3GB012	689,00 €	● F026B4GB012	689,00 €
● F026B2GB018	689,00 €	● F026B3GB018	689,00 €	● F026B4GB018	689,00 €
● F026B2GB030	689,00 €	● F026B3GB030	689,00 €	● F026B4GB030	689,00 €
● F026B2GB033	689,00 €	● F026B3GB033	689,00 €	● F026B4GB033	689,00 €
Dali					
○ F026B2GD001	689,00 €	○ F026B3GD001	689,00 €	○ F026B4GD001	689,00 €
● F026B2GD006	689,00 €	● F026B3GD006	689,00 €	● F026B4GD006	689,00 €
● F026B2GD012	689,00 €	● F026B3GD012	689,00 €	● F026B4GD012	689,00 €
● F026B2GD018	689,00 €	● F026B3GD018	689,00 €	● F026B4GD018	689,00 €
● F026B2GD030	689,00 €	● F026B3GD030	689,00 €	● F026B4GD030	689,00 €
● F026B2GD033	689,00 €	● F026B3GD033	689,00 €	● F026B4GD033	689,00 €

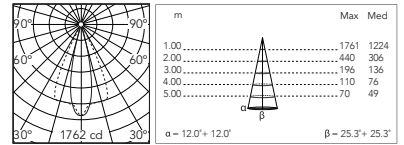

@ 3000K

Optic Wall Washer

Power Led: 10,5W - 920 lm ≠ FIXT 673 lm - 2700K/CRI 80 - 220-240V / 10,5W - 966 lm ≠ FIXT 698 lm - 3000K/CRI 80 - 220-240V / 10,5W - 1012 lm ≠ FIXT 672 lm - 4000K/CRI 80 - 220-240V

2700K		3000K		4000K	
Non Dimmable		Non Dimmable		Non Dimmable	
○ F026B2HA001	637,00 €	○ F026B3HA001	637,00 €	○ F026B4HA001	637,00 €
● F026B2HA006	637,00 €	● F026B3HA006	637,00 €	● F026B4HA006	637,00 €
● F026B2HA012	637,00 €	● F026B3HA012	637,00 €	● F026B4HA012	637,00 €
● F026B2HA018	637,00 €	● F026B3HA018	637,00 €	● F026B4HA018	637,00 €
● F026B2HA030	637,00 €	● F026B3HA030	637,00 €	● F026B4HA030	637,00 €
● F026B2HA033	637,00 €	● F026B3HA033	637,00 €	● F026B4HA033	637,00 €
1-10V					
○ F026B2HB001	689,00 €	○ F026B3HB001	689,00 €	○ F026B4HB001	689,00 €
● F026B2HB006	689,00 €	● F026B3HB006	689,00 €	● F026B4HB006	689,00 €
● F026B2HB012	689,00 €	● F026B3HB012	689,00 €	● F026B4HB012	689,00 €
● F026B2HB018	689,00 €	● F026B3HB018	689,00 €	● F026B4HB018	689,00 €
● F026B2HB030	689,00 €	● F026B3HB030	689,00 €	● F026B4HB030	689,00 €
● F026B2HB033	689,00 €	● F026B3HB033	689,00 €	● F026B4HB033	689,00 €
Dali					
○ F026B2HD001	689,00 €	○ F026B3HD001	689,00 €	○ F026B4HD001	689,00 €
● F026B2HD006	689,00 €	● F026B3HD006	689,00 €	● F026B4HD006	689,00 €
● F026B2HD012	689,00 €	● F026B3HD012	689,00 €	● F026B4HD012	689,00 €
● F026B2HD018	689,00 €	● F026B3HD018	689,00 €	● F026B4HD018	689,00 €
● F026B2HD030	689,00 €	● F026B3HD030	689,00 €	● F026B4HD030	689,00 €
● F026B2HD033	689,00 €	● F026B3HD033	689,00 €	● F026B4HD033	689,00 €

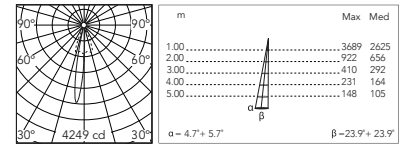

@ 3000K

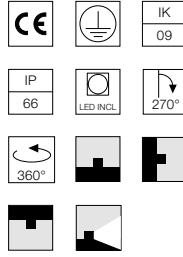
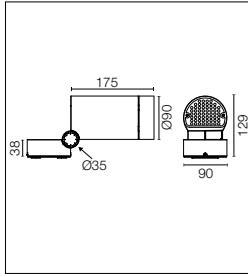

Source LED à basse consommation incluse. Équipée d'un snoot intégré pour un plus grand confort visuel: viseur asymétrique disponible en tant qu'accessoire. Les collimateurs sont des accessoires disponibles pour modifier la largeur du faisceau lumineux. Source d'alimentation électrique intégrée 220-240V ON/OFF et réglable 1-10V ou DALI. Plaque d'ancrage incluse. La connexion électrique a lieu à l'intérieur de la plaque par un connecteur étanche inclus. Pour garantir l'étanchéité, il est conseillé d'utiliser des câbles flexibles conçus pour l'extérieur. Clou métallique pour l'installation au sol, à commander séparément.

Energy-efficient Power LED source included Equipped with an integrated snoot for higher visual comfort: the asymmetrical cut visor is available as an accessory. Collimators are available as an accessory to modify the beam opening. Integrated electric power supply 220-240V ON/OFF and adjustable 1-10V or DALI. Fixing plate included. The electrical connection is made on the inside of the plate by means of a watertight connector included. To guarantee its water tightness, it is recommended to use flexible cables designed for outdoor use. Ground spike for ground installations to be ordered separately.

2200K disponible sur demande.

2200K available on request.

Optic Spot 14,5°

Power Led: 17W - 1739 lm ≠ FIXT 1443 lm - 2700K/CRI 80 - 220-240V / 17W - 1803 lm ≠ FIXT 1497 lm - 3000K/CRI 80 - 220-240V / 17W - 1868 lm ≠ FIXT 1548 lm - 4000K/CRI 80 - 220-240V

2700K

Non Dimmable

- F026C2BA001 637,00 €
- F026C2BA006 637,00 €
- F026C2BA012 637,00 €
- F026C2BA018 637,00 €
- F026C2BA030 637,00 €
- F026C2BA033 637,00 €
- 1-10V
- F026C2BB001 689,00 €
- F026C2BB006 689,00 €
- F026C2BB012 689,00 €
- F026C2BB018 689,00 €
- F026C2BB030 689,00 €
- F026C2BB033 689,00 €
- Dali
- F026C2BD001 689,00 €
- F026C2BD006 689,00 €
- F026C2BD012 689,00 €
- F026C2BD018 689,00 €
- F026C2BD030 689,00 €
- F026C2BD033 689,00 €

3000K

Non Dimmable

- F026C3BA001 637,00 €
- F026C3BA006 637,00 €
- F026C3BA012 637,00 €
- F026C3BA018 637,00 €
- F026C3BA030 637,00 €
- F026C3BA033 637,00 €
- 1-10V
- F026C3BB001 689,00 €
- F026C3BB006 689,00 €
- F026C3BB012 689,00 €
- F026C3BB018 689,00 €
- F026C3BB030 689,00 €
- F026C3BB033 689,00 €
- Dali
- F026C3BD001 689,00 €
- F026C3BD006 689,00 €
- F026C3BD012 689,00 €
- F026C3BD018 689,00 €
- F026C3BD030 689,00 €
- F026C3BD033 689,00 €

4000K

Non Dimmable

- F026C4BA001 637,00 €
- F026C4BA006 637,00 €
- F026C4BA012 637,00 €
- F026C4BA018 637,00 €
- F026C4BA030 637,00 €
- F026C4BA033 637,00 €
- 1-10V
- F026C4BB001 689,00 €
- F026C4BB006 689,00 €
- F026C4BB012 689,00 €
- F026C4BB018 689,00 €
- F026C4BB030 689,00 €
- F026C4BB033 689,00 €
- Dali
- F026C4BD001 689,00 €
- F026C4BD006 689,00 €
- F026C4BD012 689,00 €
- F026C4BD018 689,00 €
- F026C4BD030 689,00 €
- F026C4BD033 689,00 €

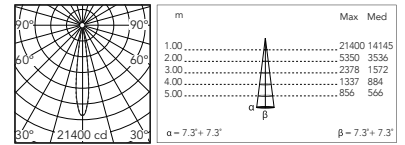

@ 3000K

Optic Medium Flood 26°

Power Led: 17W - 1739 lm ≠ FIXT 1336 lm - 2700K/CRI 80 - 220-240V / 17W - 1803 lm ≠ FIXT 1386 lm - 3000K/CRI 80 - 220-240V / 17W - 1868 lm ≠ FIXT 1434 lm - 4000K/CRI 80 - 220-240V

2700K

Non Dimmable

- F026C2CA001 637,00 €
- F026C2CA006 637,00 €
- F026C2CA012 637,00 €
- F026C2CA018 637,00 €
- F026C2CA030 637,00 €
- F026C2CA033 637,00 €
- 1-10V
- F026C2CB001 689,00 €
- F026C2CB006 689,00 €
- F026C2CB012 689,00 €
- F026C2CB018 689,00 €
- F026C2CB030 689,00 €
- F026C2CB033 689,00 €
- Dali
- F026C2CD001 689,00 €
- F026C2CD006 689,00 €
- F026C2CD012 689,00 €
- F026C2CD018 689,00 €
- F026C2CD030 689,00 €
- F026C2CD033 689,00 €

3000K

Non Dimmable

- F026C3CA001 637,00 €
- F026C3CA006 637,00 €
- F026C3CA012 637,00 €
- F026C3CA018 637,00 €
- F026C3CA030 637,00 €
- F026C3CA033 637,00 €
- 1-10V
- F026C3CB001 689,00 €
- F026C3CB006 689,00 €
- F026C3CB012 689,00 €
- F026C3CB018 689,00 €
- F026C3CB030 689,00 €
- F026C3CB033 689,00 €
- Dali
- F026C3CD001 689,00 €
- F026C3CD006 689,00 €
- F026C3CD012 689,00 €
- F026C3CD018 689,00 €
- F026C3CD030 689,00 €
- F026C3CD033 689,00 €

4000K

Non Dimmable

- F026C4CA001 637,00 €
- F026C4CA006 637,00 €
- F026C4CA012 637,00 €
- F026C4CA018 637,00 €
- F026C4CA030 637,00 €
- F026C4CA033 637,00 €
- 1-10V
- F026C4CB001 689,00 €
- F026C4CB006 689,00 €
- F026C4CB012 689,00 €
- F026C4CB018 689,00 €
- F026C4CB030 689,00 €
- F026C4CB033 689,00 €
- Dali
- F026C4CD001 689,00 €
- F026C4CD006 689,00 €
- F026C4CD012 689,00 €
- F026C4CD018 689,00 €
- F026C4CD030 689,00 €
- F026C4CD033 689,00 €

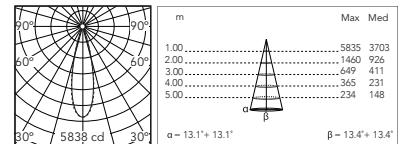

@ 3000K

Spine 2 Ultra Hp

Optic Flood 36°

Power Led: 17W - 1739 lm ≠ FIXT 1302 lm - 2700K/CRI 80 - 220-240V / 17W - 1803 lm ≠ FIXT 1351 lm - 3000K/CRI 80 - 220-240V / 17W - 1868 lm ≠ FIXT 1397 lm - 4000K/CRI 80 - 220-240V

2700K		3000K		4000K	
Non Dimmable		Non Dimmable		Non Dimmable	
○ F026C2DA001	637,00 €	○ F026C3DA001	637,00 €	○ F026C4DA001	637,00 €
● F026C2DA006	637,00 €	● F026C3DA006	637,00 €	● F026C4DA006	637,00 €
● F026C2DA012	637,00 €	● F026C3DA012	637,00 €	● F026C4DA012	637,00 €
● F026C2DA018	637,00 €	● F026C3DA018	637,00 €	● F026C4DA018	637,00 €
● F026C2DA030	637,00 €	● F026C3DA030	637,00 €	● F026C4DA030	637,00 €
● F026C2DA033	637,00 €	● F026C3DA033	637,00 €	● F026C4DA033	637,00 €
1-10V					
○ F026C2DB001	689,00 €	○ F026C3DB001	689,00 €	○ F026C4DB001	689,00 €
● F026C2DB006	689,00 €	● F026C3DB006	689,00 €	● F026C4DB006	689,00 €
● F026C2DB012	689,00 €	● F026C3DB012	689,00 €	● F026C4DB012	689,00 €
● F026C2DB018	689,00 €	● F026C3DB018	689,00 €	● F026C4DB018	689,00 €
● F026C2DB030	689,00 €	● F026C3DB030	689,00 €	● F026C4DB030	689,00 €
● F026C2DB033	689,00 €	● F026C3DB033	689,00 €	● F026C4DB033	689,00 €
Dali					
○ F026C2DD001	689,00 €	○ F026C3DD001	689,00 €	○ F026C4DD001	689,00 €
● F026C2DD006	689,00 €	● F026C3DD006	689,00 €	● F026C4DD006	689,00 €
● F026C2DD012	689,00 €	● F026C3DD012	689,00 €	● F026C4DD012	689,00 €
● F026C2DD018	689,00 €	● F026C3DD018	689,00 €	● F026C4DD018	689,00 €
● F026C2DD030	689,00 €	● F026C3DD030	689,00 €	● F026C4DD030	689,00 €
● F026C2DD033	689,00 €	● F026C3DD033	689,00 €	● F026C4DD033	689,00 €

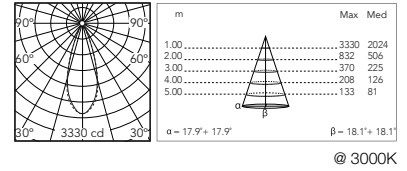

Optic Wide Flood 52°

Power Led: 17W - 1739 lm ≠ FIXT 1303 lm - 2700K/CRI 80 - 220-240V / 17W - 1803 lm ≠ FIXT 1357 lm - 3000K/CRI 80 - 220-240V / 17W - 1868 lm ≠ FIXT 1411 lm - 4000K/CRI 80 - 220-240V

2700K		3000K		4000K	
Non Dimmable		Non Dimmable		Non Dimmable	
○ F026C2EA001	637,00 €	○ F026C3EA001	637,00 €	○ F026C4EA001	637,00 €
● F026C2EA006	637,00 €	● F026C3EA006	637,00 €	● F026C4EA006	637,00 €
● F026C2EA012	637,00 €	● F026C3EA012	637,00 €	● F026C4EA012	637,00 €
● F026C2EA018	637,00 €	● F026C3EA018	637,00 €	● F026C4EA018	637,00 €
● F026C2EA030	637,00 €	● F026C3EA030	637,00 €	● F026C4EA030	637,00 €
● F026C2EA033	637,00 €	● F026C3EA033	637,00 €	● F026C4EA033	637,00 €
1-10V					
○ F026C2EB001	689,00 €	○ F026C3EB001	689,00 €	○ F026C4EB001	689,00 €
● F026C2EB006	689,00 €	● F026C3EB006	689,00 €	● F026C4EB006	689,00 €
● F026C2EB012	689,00 €	● F026C3EB012	689,00 €	● F026C4EB012	689,00 €
● F026C2EB018	689,00 €	● F026C3EB018	689,00 €	● F026C4EB018	689,00 €
● F026C2EB030	689,00 €	● F026C3EB030	689,00 €	● F026C4EB030	689,00 €
● F026C2EB033	689,00 €	● F026C3EB033	689,00 €	● F026C4EB033	689,00 €
Dali					
○ F026C2ED001	689,00 €	○ F026C3ED001	689,00 €	○ F026C4ED001	689,00 €
● F026C2ED006	689,00 €	● F026C3ED006	689,00 €	● F026C4ED006	689,00 €
● F026C2ED012	689,00 €	● F026C3ED012	689,00 €	● F026C4ED012	689,00 €
● F026C2ED018	689,00 €	● F026C3ED018	689,00 €	● F026C4ED018	689,00 €
● F026C2ED030	689,00 €	● F026C3ED030	689,00 €	● F026C4ED030	689,00 €
● F026C2ED033	689,00 €	● F026C3ED033	689,00 €	● F026C4ED033	689,00 €

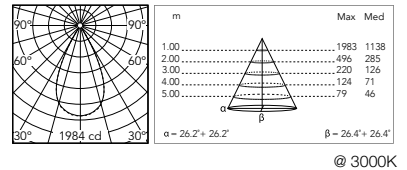

Optic Elliptical 1 14° x 50°

Power Led: 17W - 1739 lm ≠ FIXT 1315 lm - 2700K/CRI 80 - 220-240V / 17W - 1803 lm ≠ FIXT 1364 lm - 3000K/CRI 80 - 220-240V / 17W - 1868 lm ≠ FIXT 1410 lm - 4000K/CRI 80 - 220-240V

2700K		3000K		4000K	
Non Dimmable		Non Dimmable		Non Dimmable	
○ F026C2FA001	637,00 €	○ F026C3FA001	637,00 €	○ F026C4FA001	637,00 €
● F026C2FA006	637,00 €	● F026C3FA006	637,00 €	● F026C4FA006	637,00 €
● F026C2FA012	637,00 €	● F026C3FA012	637,00 €	● F026C4FA012	637,00 €
● F026C2FA018	637,00 €	● F026C3FA018	637,00 €	● F026C4FA018	637,00 €
● F026C2FA030	637,00 €	● F026C3FA030	637,00 €	● F026C4FA030	637,00 €
● F026C2FA033	637,00 €	● F026C3FA033	637,00 €	● F026C4FA033	637,00 €
1-10V					
○ F026C2FB001	689,00 €	○ F026C3FB001	689,00 €	○ F026C4FB001	689,00 €
● F026C2FB006	689,00 €	● F026C3FB006	689,00 €	● F026C4FB006	689,00 €
● F026C2FB012	689,00 €	● F026C3FB012	689,00 €	● F026C4FB012	689,00 €
● F026C2FB018	689,00 €	● F026C3FB018	689,00 €	● F026C4FB018	689,00 €
● F026C2FB030	689,00 €	● F026C3FB030	689,00 €	● F026C4FB030	689,00 €
● F026C2FB033	689,00 €	● F026C3FB033	689,00 €	● F026C4FB033	689,00 €
Dali					
○ F026C2FD001	689,00 €	○ F026C3FD001	689,00 €	○ F026C4FD001	689,00 €
● F026C2FD006	689,00 €	● F026C3FD006	689,00 €	● F026C4FD006	689,00 €
● F026C2FD012	689,00 €	● F026C3FD012	689,00 €	● F026C4FD012	689,00 €
● F026C2FD018	689,00 €	● F026C3FD018	689,00 €	● F026C4FD018	689,00 €
● F026C2FD030	689,00 €	● F026C3FD030	689,00 €	● F026C4FD030	689,00 €
● F026C2FD033	689,00 €	● F026C3FD033	689,00 €	● F026C4FD033	689,00 €

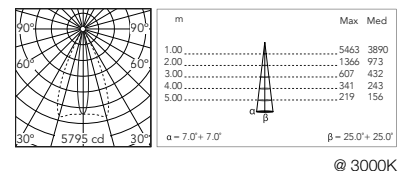

Spine 2 Ultra Hp

Optic Elliptical 2 25° x 52°

Power Led: 17W - 1739 lm ≠ FIXT 1298 lm - 2700K/CRI 80 - 220-240V / 17W - 1803 lm ≠ FIXT 1351 lm - 3000K/CRI 80 - 220-240V / 17W - 1868 lm ≠ FIXT 1393 lm - 4000K/CRI 80 - 220-240V

2700K

Non Dimmable

○ F026C2GA001	637,00 €
● F026C2GA006	637,00 €
● F026C2GA012	637,00 €
● F026C2GA018	637,00 €
● F026C2GA030	637,00 €
● F026C2GA033	637,00 €
1-10V	
○ F026C2GB001	689,00 €
● F026C2GB006	689,00 €
● F026C2GB012	689,00 €
● F026C2GB018	689,00 €
● F026C2GB030	689,00 €
● F026C2GB033	689,00 €
Dali	
○ F026C2GD001	689,00 €
● F026C2GD006	689,00 €
● F026C2GD012	689,00 €
● F026C2GD018	689,00 €
● F026C2GD030	689,00 €
● F026C2GD033	689,00 €

3000K

Non Dimmable

○ F026C3GA001	637,00 €
● F026C3GA006	637,00 €
● F026C3GA012	637,00 €
● F026C3GA018	637,00 €
● F026C3GA030	637,00 €
● F026C3GA033	637,00 €
1-10V	
○ F026C3GB001	689,00 €
● F026C3GB006	689,00 €
● F026C3GB012	689,00 €
● F026C3GB018	689,00 €
● F026C3GB030	689,00 €
● F026C3GB033	689,00 €
Dali	
○ F026C3GD001	689,00 €
● F026C3GD006	689,00 €
● F026C3GD012	689,00 €
● F026C3GD018	689,00 €
● F026C3GD030	689,00 €
● F026C3GD033	689,00 €

4000K

Non Dimmable

○ F026C4GA001	637,00 €
● F026C4GA006	637,00 €
● F026C4GA012	637,00 €
● F026C4GA018	637,00 €
● F026C4GA030	637,00 €
● F026C4GA033	637,00 €
1-10V	
○ F026C4GB001	689,00 €
● F026C4GB006	689,00 €
● F026C4GB012	689,00 €
● F026C4GB018	689,00 €
● F026C4GB030	689,00 €
● F026C4GB033	689,00 €
Dali	
○ F026C4GD001	689,00 €
● F026C4GD006	689,00 €
● F026C4GD012	689,00 €
● F026C4GD018	689,00 €
● F026C4GD030	689,00 €
● F026C4GD033	689,00 €

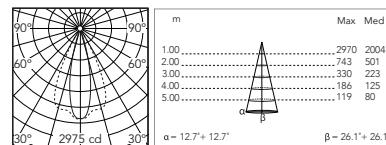

@ 3000K

Optic Wall Washer

Power Led: 17W - 1739 lm ≠ FIXT 1277 lm - 2700K/CRI 80 - 220-240V / 17W - 1803 lm ≠ FIXT 1325 lm - 3000K/CRI 80 - 220-240V / 17W - 1868 lm ≠ FIXT 1370 lm - 4000K/CRI 80 - 220-240V

2700K

Non Dimmable

○ F026C2HA001	637,00 €
● F026C2HA006	637,00 €
● F026C2HA012	637,00 €
● F026C2HA018	637,00 €
● F026C2HA030	637,00 €
● F026C2HA033	637,00 €
1-10V	
○ F026C2HB001	689,00 €
● F026C2HB006	689,00 €
● F026C2HB012	689,00 €
● F026C2HB018	689,00 €
● F026C2HB030	689,00 €
● F026C2HB033	689,00 €
Dali	
○ F026C2HD001	689,00 €
● F026C2HD006	689,00 €
● F026C2HD012	689,00 €
● F026C2HD018	689,00 €
● F026C2HD030	689,00 €
● F026C2HD033	689,00 €

3000K

Non Dimmable

○ F026C3HA001	637,00 €
● F026C3HA006	637,00 €
● F026C3HA012	637,00 €
● F026C3HA018	637,00 €
● F026C3HA030	637,00 €
● F026C3HA033	637,00 €
1-10V	
○ F026C3HB001	689,00 €
● F026C3HB006	689,00 €
● F026C3HB012	689,00 €
● F026C3HB018	689,00 €
● F026C3HB030	689,00 €
● F026C3HB033	689,00 €
Dali	
○ F026C3HD001	689,00 €
● F026C3HD006	689,00 €
● F026C3HD012	689,00 €
● F026C3HD018	689,00 €
● F026C3HD030	689,00 €
● F026C3HD033	689,00 €

4000K

Non Dimmable

○ F026C4HA001	637,00 €
● F026C4HA006	637,00 €
● F026C4HA012	637,00 €
● F026C4HA018	637,00 €
● F026C4HA030	637,00 €
● F026C4HA033	637,00 €
1-10V	
○ F026C4HB001	689,00 €
● F026C4HB006	689,00 €
● F026C4HB012	689,00 €
● F026C4HB018	689,00 €
● F026C4HB030	689,00 €
● F026C4HB033	689,00 €
Dali	
○ F026C4HD001	689,00 €
● F026C4HD006	689,00 €
● F026C4HD012	689,00 €
● F026C4HD018	689,00 €
● F026C4HD030	689,00 €
● F026C4HD033	689,00 €

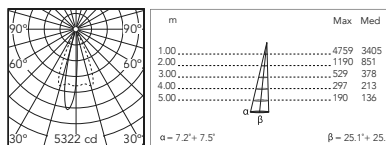

@ 3000K

Spine 2 Ultra: Accessoires / Accessories

Visueur	Visor	○ F026Z050001	57,00 €	
		● F026Z050006	57,00 €	
		● F026Z050012	57,00 €	
		● F026Z050018	57,00 €	
		● F026Z050030	57,00 €	

Pique de terre.	Ground spike.	F026Z010000	27,00 €	
-----------------	---------------	-------------	---------	--

Honeycomb	Honeycomb Louvre	F026Z060000	21,00 €	
-----------	------------------	-------------	---------	--

Lentilles de conversion / Converter lenses:

- Converter Spine 2 Optic Medium Flood	F029Z020000	37,00 €	
- Converter Spine 2 Optic Flood	F029Z021000	37,00 €	
- Converter Spine 2 Optic Wide Flood	F029Z022000	37,00 €	
- Converter Spine 2 Optic Elliptic 1	F029Z023000	37,00 €	
- Converter Spine 2 Optic Elliptic 2	F029Z024000	37,00 €	
- Converter Spine 2 Optic Wall Washer	F029Z025000	37,00 €	

Spine

Spine F

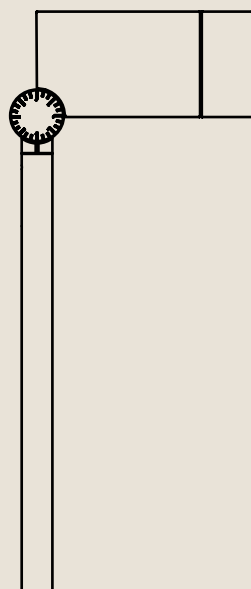

Une barre spéciale peut être installée facilement au sol, ce qui augmente la polyvalence du produit.

A special rod can be easily installed in the ground increasing the product versatility.

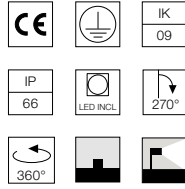
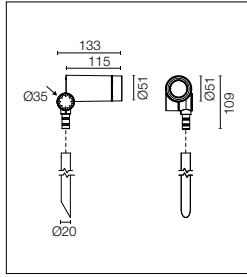

Source Power LED incluse. Équipée d'un snoot intégré pour un plus grand confort visuel. Les collimateurs sont des accessoires disponibles pour modifier la largeur du faisceau lumineux. Source d'alimentation électrique intégrée 220-240V ON/OFF. Plaque d'ancrage incluse. La connexion électrique a lieu à l'intérieur de la plaque par un connecteur étanche inclus. Pour garantir l'étanchéité, il est conseillé d'utiliser des câbles flexibles conçus pour l'extérieur. Clou métallique pour l'installation au sol, à commander séparément.

Power LED source included. Equipped with an integrated snoot for higher visual comfort. Collimators are available as an accessory to modify the beam opening. Integrated electric power supply 220-240V ON/OFF. Fixing plate included. The electrical connection is made on the inside of the plate by means of a watertight connector included. To guarantee its water tightness, it is recommended to use flexible cables designed for outdoor use. Ground spike for ground installations to be ordered separately.

2200K disponible sur demande.

2200K available on request.

Version dimmable DALI disponible sur demande.

DALI dimmable version available on request.

Optic Spot 14°

Power Led: 5W - 481 lm ≠ FIXT 368 lm - 2700K/CRI 80 - 220-240V / 5W - 493 lm ≠ FIXT 377 lm - 3000K/CRI 80 - 220-240V / 5W - 540 lm ≠ FIXT 413 lm - 4000K/CRI 80 - 220-240V

2700K

Non Dimmable

○ F027L2BA001	316,00 €
● F027L2BA006	316,00 €
● F027L2BA012	316,00 €
● F027L2BA018	316,00 €
● F027L2BA030	316,00 €
● F027L2BA033	316,00 €

3000K

Non Dimmable

○ F027L3BA001	316,00 €
● F027L3BA006	316,00 €
● F027L3BA012	316,00 €
● F027L3BA018	316,00 €
● F027L3BA030	316,00 €
● F027L3BA033	316,00 €

4000K

Non Dimmable

○ F027L4BA001	316,00 €
● F027L4BA006	316,00 €
● F027L4BA012	316,00 €
● F027L4BA018	316,00 €
● F027L4BA030	316,00 €
● F027L4BA033	316,00 €

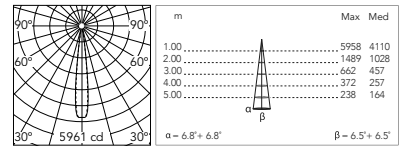

@ 3000K

Optic Medium Flood 26°

Power Led: 5W - 481 lm ≠ FIXT 337 lm - 2700K/CRI 80 - 220-240V / 5W - 493 lm ≠ FIXT 346 lm - 3000K/CRI 80 - 220-240V / 5W - 540 lm ≠ FIXT 378 lm - 4000K/CRI 80 - 220-240V

2700K

Non Dimmable

○ F027L2CA001	316,00 €
● F027L2CA006	316,00 €
● F027L2CA012	316,00 €
● F027L2CA018	316,00 €
● F027L2CA030	316,00 €
● F027L2CA033	316,00 €

3000K

Non Dimmable

○ F027L3CA001	316,00 €
● F027L3CA006	316,00 €
● F027L3CA012	316,00 €
● F027L3CA018	316,00 €
● F027L3CA030	316,00 €
● F027L3CA033	316,00 €

4000K

Non Dimmable

○ F027L4CA001	316,00 €
● F027L4CA006	316,00 €
● F027L4CA012	316,00 €
● F027L4CA018	316,00 €
● F027L4CA030	316,00 €
● F027L4CA033	316,00 €

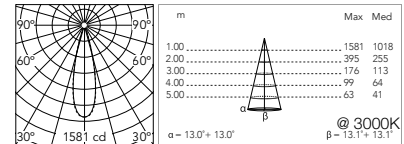

@ 3000K

Optic Flood 36°

Power Led: 5W - 481 lm ≠ FIXT 332 lm - 2700K/CRI 80 - 220-240V / 5W - 493 lm ≠ FIXT 340 lm - 3000K/CRI 80 - 220-240V / 5W - 540 lm ≠ FIXT 373 lm - 4000K/CRI 80 - 220-240V

2700K

Non Dimmable

○ F027L2DA001	316,00 €
● F027L2DA006	316,00 €
● F027L2DA012	316,00 €
● F027L2DA018	316,00 €
● F027L2DA030	316,00 €
● F027L2DA033	316,00 €

3000K

Non Dimmable

○ F027L3DA001	316,00 €
● F027L3DA006	316,00 €
● F027L3DA012	316,00 €
● F027L3DA018	316,00 €
● F027L3DA030	316,00 €
● F027L3DA033	316,00 €

4000K

Non Dimmable

○ F027L4DA001	316,00 €
● F027L4DA006	316,00 €
● F027L4DA012	316,00 €
● F027L4DA018	316,00 €
● F027L4DA030	316,00 €
● F027L4DA033	316,00 €

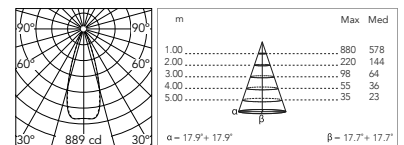

@ 3000K

Optic Wide Flood 50°

Power Led: 5W - 481 lm ≠ FIXT 324 lm - 2700K/CRI 80 - 220-240V / 5W - 493 lm ≠ FIXT 332 lm - 3000K/CRI 80 - 220-240V / 5W - 540 lm ≠ FIXT 363 lm - 4000K/CRI 80 - 220-240V

2700K

Non Dimmable

○ F027L2EA001	316,00 €
● F027L2EA006	316,00 €
● F027L2EA012	316,00 €
● F027L2EA018	316,00 €
● F027L2EA030	316,00 €
● F027L2EA033	316,00 €

3000K

Non Dimmable

○ F027L3EA001	316,00 €
● F027L3EA006	316,00 €
● F027L3EA012	316,00 €
● F027L3EA018	316,00 €
● F027L3EA030	316,00 €
● F027L3EA033	316,00 €

4000K

Non Dimmable

○ F027L4EA001	316,00 €
● F027L4EA006	316,00 €
● F027L4EA012	316,00 €
● F027L4EA018	316,00 €
● F027L4EA030	316,00 €
● F027L4EA033	316,00 €

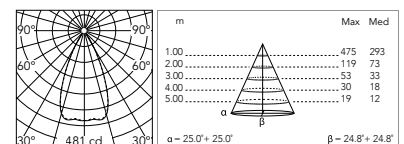

@ 3000K

Optic Elliptical 1 12° x 50°

Power Led: 5W - 481 lm ≠ FIXT 342 lm - 2700K/CRI 80 - 220-240V / 5W - 493 lm ≠ FIXT 350 lm - 3000K/CRI 80 - 220-240V / 5W - 540 lm ≠ FIXT 383 lm - 4000K/CRI 80 - 220-240V

2700K

Non Dimmable

○ F027L2FA001	316,00 €
● F027L2FA006	316,00 €
● F027L2FA012	316,00 €
● F027L2FA018	316,00 €
● F027L2FA030	316,00 €
● F027L2FA033	316,00 €

3000K

Non Dimmable

○ F027L3FA001	316,00 €
● F027L3FA006	316,00 €
● F027L3FA012	316,00 €
● F027L3FA018	316,00 €
● F027L3FA030	316,00 €
● F027L3FA033	316,00 €

4000K

Non Dimmable

○ F027L4FA001	316,00 €
● F027L4FA006	316,00 €
● F027L4FA012	316,00 €
● F027L4FA018	316,00 €
● F027L4FA030	316,00 €
● F027L4FA033	316,00 €

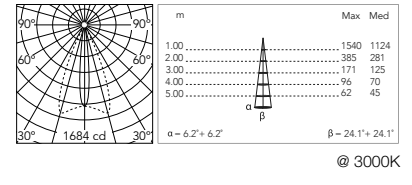

Optic Elliptical 2 26° x 51°

Power Led: 5W - 481 lm ≠ FIXT 334 lm - 2700K/CRI 80 - 220-240V / 5W - 493 lm ≠ FIXT 342 lm - 3000K/CRI 80 - 220-240V / 5W - 540 lm ≠ FIXT 375 lm - 4000K/CRI 80 - 220-240V

2700K

Non Dimmable

○ F027L2GA001	316,00 €
● F027L2GA006	316,00 €
● F027L2GA012	316,00 €
● F027L2GA018	316,00 €
● F027L2GA030	316,00 €
● F027L2GA033	316,00 €

3000K

Non Dimmable

○ F027L3GA001	316,00 €
● F027L3GA006	316,00 €
● F027L3GA012	316,00 €
● F027L3GA018	316,00 €
● F027L3GA030	316,00 €
● F027L3GA033	316,00 €

4000K

Non Dimmable

○ F027L4GA001	316,00 €
● F027L4GA006	316,00 €
● F027L4GA012	316,00 €
● F027L4GA018	316,00 €
● F027L4GA030	316,00 €
● F027L4GA033	316,00 €

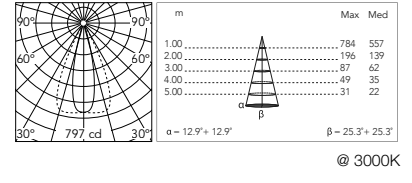

Optic Wall Washer

Power Led: 5W - 481 lm ≠ FIXT 321 lm - 2700K/CRI 80 - 220-240V / 5W - 493 lm ≠ FIXT 329 lm - 3000K/CRI 80 - 220-240V / 5W - 540 lm ≠ FIXT 360 lm - 4000K/CRI 80 - 220-240V

2700K

Non Dimmable

○ F027L2HA001	316,00 €
● F027L2HA006	316,00 €
● F027L2HA012	316,00 €
● F027L2HA018	316,00 €
● F027L2HA030	316,00 €
● F027L2HA033	316,00 €

3000K

Non Dimmable

○ F027L3HA001	316,00 €
● F027L3HA006	316,00 €
● F027L3HA012	316,00 €
● F027L3HA018	316,00 €
● F027L3HA030	316,00 €
● F027L3HA033	316,00 €

4000K

Non Dimmable

○ F027L4HA001	316,00 €
● F027L4HA006	316,00 €
● F027L4HA012	316,00 €
● F027L4HA018	316,00 €
● F027L4HA030	316,00 €
● F027L4HA033	316,00 €

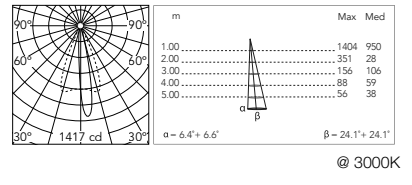

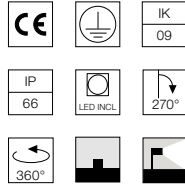
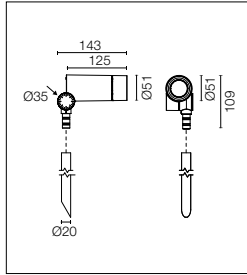

Source Power LED incluse. Équipée d'un snoot intégré pour un plus grand confort visuel. Les collimateurs sont des accessoires disponibles pour modifier la largeur du faisceau lumineux. Source d'alimentation électrique intégrée 220-240V ON/OFF. Plaque d'ancrage incluse. La connexion électrique a lieu à l'intérieur de la plaque par un connecteur étanche inclus. Pour garantir l'étanchéité, il est conseillé d'utiliser des câbles flexibles conçus pour l'extérieur. Clou métallique pour l'installation au sol, à commander séparément.

Power LED source included. Equipped with an integrated snoot for higher visual comfort. Collimators are available as an accessory to modify the beam opening. Integrated electric power supply 220-240V ON/OFF. Fixing plate included. The electrical connection is made on the inside of the plate by means of a watertight connector included. To guarantee its water tightness, it is recommended to use flexible cables designed for outdoor use. Ground spike for ground installations to be ordered separately.

2200K disponible sur demande.

2200K available on request.

Version dimmable DALI disponible sur demande.

DALI dimmable version available on request.

Optic Spot 14°

Power Led: 5W - 481 lm ≠ FIXT 368 lm - 2700K/CRI 80 - 220-240V / 5W - 493 lm ≠ FIXT 377 lm - 3000K/CRI 80 - 220-240V / 5W - 540 lm ≠ FIXT 413 lm - 4000K/CRI 80 - 220-240V

2700K

Non Dimmable

○ F027G2BA001	349,00 €
● F027G2BA006	349,00 €
● F027G2BA012	349,00 €
● F027G2BA018	349,00 €
● F027G2BA030	349,00 €
● F027G2BA033	349,00 €

3000K

Non Dimmable

○ F027G3BA001	349,00 €
● F027G3BA006	349,00 €
● F027G3BA012	349,00 €
● F027G3BA018	349,00 €
● F027G3BA030	349,00 €
● F027G3BA033	349,00 €

4000K

Non Dimmable

○ F027G4BA001	349,00 €
● F027G4BA006	349,00 €
● F027G4BA012	349,00 €
● F027G4BA018	349,00 €
● F027G4BA030	349,00 €
● F027G4BA033	349,00 €

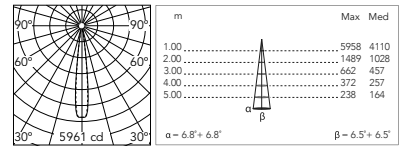

@ 3000K

Optic Medium Flood 26°

Power Led: 5W - 481 lm ≠ FIXT 337 lm - 2700K/CRI 80 - 220-240V / 5W - 493 lm ≠ FIXT 346 lm - 3000K/CRI 80 - 220-240V / 5W - 540 lm ≠ FIXT 378 lm - 4000K/CRI 80 - 220-240V

2700K

Non Dimmable

○ F027G2CA001	349,00 €
● F027G2CA006	349,00 €
● F027G2CA012	349,00 €
● F027G2CA018	349,00 €
● F027G2CA030	349,00 €
● F027G2CA033	349,00 €

3000K

Non Dimmable

○ F027G3CA001	349,00 €
● F027G3CA006	349,00 €
● F027G3CA012	349,00 €
● F027G3CA018	349,00 €
● F027G3CA030	349,00 €
● F027G3CA033	349,00 €

4000K

Non Dimmable

○ F027G4CA001	349,00 €
● F027G4CA006	349,00 €
● F027G4CA012	349,00 €
● F027G4CA018	349,00 €
● F027G4CA030	349,00 €
● F027G4CA033	349,00 €

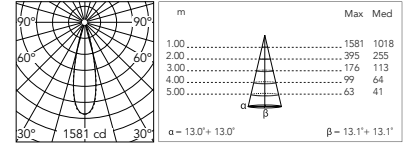

@ 3000K

Optic Flood 36°

Power Led: 5W - 481 lm ≠ FIXT 332 lm - 2700K/CRI 80 - 220-240V / 5W - 493 lm ≠ FIXT 340 lm - 3000K/CRI 80 - 220-240V / 5W - 540 lm ≠ FIXT 373 lm - 4000K/CRI 80 - 220-240V

2700K

Non Dimmable

○ F027G2DA001	349,00 €
● F027G2DA006	349,00 €
● F027G2DA012	349,00 €
● F027G2DA018	349,00 €
● F027G2DA030	349,00 €
● F027G2DA033	349,00 €

3000K

Non Dimmable

○ F027G3DA001	349,00 €
● F027G3DA006	349,00 €
● F027G3DA012	349,00 €
● F027G3DA018	349,00 €
● F027G3DA030	349,00 €
● F027G3DA033	349,00 €

4000K

Non Dimmable

○ F027G4DA001	349,00 €
● F027G4DA006	349,00 €
● F027G4DA012	349,00 €
● F027G4DA018	349,00 €
● F027G4DA030	349,00 €
● F027G4DA033	349,00 €

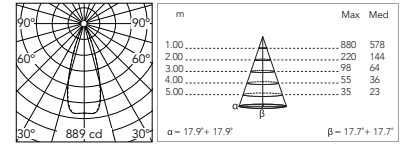

@ 3000K

Optic Wide Flood 50°

Power Led: 5W - 481 lm ≠ FIXT 324 lm - 2700K/CRI 80 - 220-240V / 5W - 493 lm ≠ FIXT 332 lm - 3000K/CRI 80 - 220-240V / 5W - 540 lm ≠ FIXT 363 lm - 4000K/CRI 80 - 220-240V

2700K

Non Dimmable

○ F027G2EA001	349,00 €
● F027G2EA006	349,00 €
● F027G2EA012	349,00 €
● F027G2EA018	349,00 €
● F027G2EA030	349,00 €
● F027G2EA033	349,00 €

3000K

Non Dimmable

○ F027G3EA001	349,00 €
● F027G3EA006	349,00 €
● F027G3EA012	349,00 €
● F027G3EA018	349,00 €
● F027G3EA030	349,00 €
● F027G3EA033	349,00 €

4000K

Non Dimmable

○ F027G4EA001	349,00 €
● F027G4EA006	349,00 €
● F027G4EA012	349,00 €
● F027G4EA018	349,00 €
● F027G4EA030	349,00 €
● F027G4EA033	349,00 €

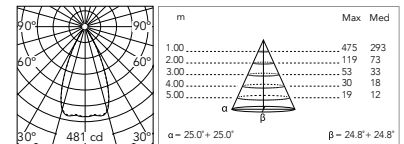

@ 3000K

Spine F 0 Ultra

Optic Elliptical 1 12° x 50°

Power Led: 5W - 481 lm ≠ FIXT 342 lm - 2700K/CRI 80 - 220-240V / 5W - 493 lm ≠ FIXT 350 lm - 3000K/CRI 80 - 220-240V / 5W - 540 lm ≠ FIXT 383 lm - 4000K/CRI 80 - 220-240V

2700K

Non Dimmable

○ F027G2FA001	349,00 €
● F027G2FA006	349,00 €
● F027G2FA012	349,00 €
● F027G2FA018	349,00 €
● F027G2FA030	349,00 €
● F027G2FA033	349,00 €

3000K

Non Dimmable

○ F027G3FA001	349,00 €
● F027G3FA006	349,00 €
● F027G3FA012	349,00 €
● F027G3FA018	349,00 €
● F027G3FA030	349,00 €
● F027G3FA033	349,00 €

4000K

Non Dimmable

○ F027G4FA001	349,00 €
● F027G4FA006	349,00 €
● F027G4FA012	349,00 €
● F027G4FA018	349,00 €
● F027G4FA030	349,00 €
● F027G4FA033	349,00 €

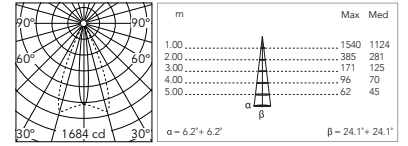

@ 3000K

Optic Elliptical 2 26° x 51°

Power Led: 5W - 481 lm ≠ FIXT 334 lm - 2700K/CRI 80 - 220-240V / 5W - 493 lm ≠ FIXT 342 lm - 3000K/CRI 80 - 220-240V / 5W - 540 lm ≠ FIXT 375 lm - 4000K/CRI 80 - 220-240V

2700K

Non Dimmable

○ F027G2GA001	349,00 €
● F027G2GA006	349,00 €
● F027G2GA012	349,00 €
● F027G2GA018	349,00 €
● F027G2GA030	349,00 €
● F027G2GA033	349,00 €

3000K

Non Dimmable

○ F027G3GA001	349,00 €
● F027G3GA006	349,00 €
● F027G3GA012	349,00 €
● F027G3GA018	349,00 €
● F027G3GA030	349,00 €
● F027G3GA033	349,00 €

4000K

Non Dimmable

○ F027G4GA001	349,00 €
● F027G4GA006	349,00 €
● F027G4GA012	349,00 €
● F027G4GA018	349,00 €
● F027G4GA030	349,00 €
● F027G4GA033	349,00 €

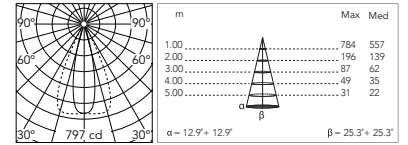

@ 3000K

Optic Wall Washer

Power Led: 5W - 481 lm ≠ FIXT 321 lm - 2700K/CRI 80 - 220-240V / 5W - 493 lm ≠ FIXT 329 lm - 3000K/CRI 80 - 220-240V / 5W - 540 lm ≠ FIXT 360 lm - 4000K/CRI 80 - 220-240V

2700K

Non Dimmable

○ F027G2HA001	349,00 €
● F027G2HA006	349,00 €
● F027G2HA012	349,00 €
● F027G2HA018	349,00 €
● F027G2HA030	349,00 €
● F027G2HA033	349,00 €

3000K

Non Dimmable

○ F027G3HA001	349,00 €
● F027G3HA006	349,00 €
● F027G3HA012	349,00 €
● F027G3HA018	349,00 €
● F027G3HA030	349,00 €
● F027G3HA033	349,00 €

4000K

Non Dimmable

○ F027G4HA001	349,00 €
● F027G4HA006	349,00 €
● F027G4HA012	349,00 €
● F027G4HA018	349,00 €
● F027G4HA030	349,00 €
● F027G4HA033	349,00 €

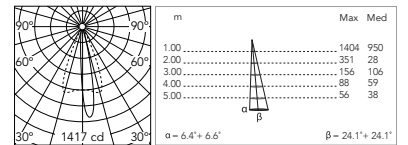



@ 3000K

Spine F 0: Accessoires / Accessories

Viseur	Visor	○ F027Z050001	47,00 €	 
		● F027Z050006	47,00 €	
		● F027Z050012	47,00 €	
		● F027Z050018	47,00 €	
		● F027Z050030	47,00 €	
		● F027Z050033	47,00 €	

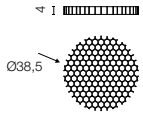
Spine F 0 Ultra: Accessoires / Accessories

Honeycomb	Honeycomb Louvre	F027Z060000	17,00 €	 
-----------	------------------	-------------	---------	---

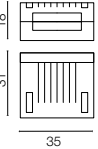
Gelbox IPX8 pour le raccordement électrique.	Gelbox IPX8 for splicing connectors.	F990C100000	14,00 €	 
--	--------------------------------------	-------------	---------	---

Lentilles de conversion / Converter lenses:

- Converter Spine 0 / Spine 1 Optic Medium Flood	F029Z010000	35,00 €	 
- Converter Spine 0 / Spine 1 Optic Flood	F029Z011000	35,00 €	
- Converter Spine 0 / Spine 1 Optic Wide Flood	F029Z012000	35,00 €	
- Converter Spine 0 / Spine 1 Optic Elliptic 1	F029Z013000	35,00 €	
- Converter Spine 0 / Spine 1 Optic Elliptic 2	F029Z014000	35,00 €	
- Converter Spine 0 / Spine 1 Optic Wall Washer	F029Z015000	35,00 €	

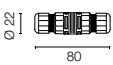
Système de jonction IP68 H2O Stop anti-condensation à 2 voies 4 pôles.	2 way terminal block 4 poles IP68 H2O Stop.	F990C00A000	33,00 €	 
--	---	-------------	---------	---

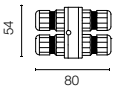
Système de jonction IP68 H2O Stop anti-condensation à 3/4 voies 4 pôles. (Ø5,5÷12mm câble).	3/4 way terminal block 4 poles IP68 H2O Stop. (ø5,5÷12mm cable).	F990C010000	60,00 €	 
---	--	-------------	---------	---

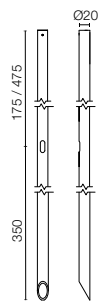
Poteau longueur 200 - 500 mm au-dessus du sol pour des installations au sol.	Pole with an overground length of 200 - 500 mm for ground installation.	200 mm		 
		○ F026Z020001	51,00 €	
		● F026Z020006	51,00 €	
		● F026Z020012	51,00 €	
		● F026Z020018	51,00 €	
		● F026Z020030	51,00 €	
		● F026Z020033	51,00 €	
		500 mm		
		○ F026Z030001	55,00 €	
		● F026Z030006	55,00 €	
		● F026Z030012	55,00 €	
		● F026Z030018	55,00 €	
		● F026Z030030	55,00 €	
		● F026Z030033	55,00 €	



Spine F 1 Absolute

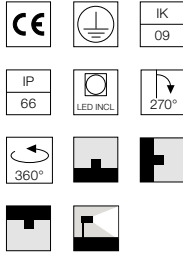
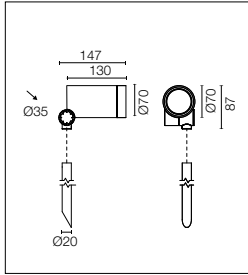

Source LED COB incluse. Source d'alimentation électrique intégrée 220-240V ON/OFF. Équipée d'un câble en néoprène de 5m (10m sur commande) pour une connexion à distance; pour garantir l'étanchéité, il est conseillé d'utiliser des câbles flexibles conçus pour l'extérieur. La tige pour les installations au sol est disponible en deux tailles et doit se commander séparément. Sur demande, version réglable 1-10V ou DALI avec source d'alimentation à distance 24Vdc.

LED COB light source included. Integrated electric power supply 220-240V ON/OFF. Equipped with a 5m neoprene cable (10m upon request) for remote connection. To guarantee its water tightness, it is recommended to use flexible cables designed for outdoor use. The rod for ground installations is available in two sizes and needs to be ordered separately. Upon request: 1-10V or DALI dimmable version with 24Vdc remote power supply.

Optic Spot 15°

CoB Led: 11W - 1247 lm ≠ FIXT 923 lm - 2700K/CRI 80 - 220-240V / 11W - 1325 lm ≠ FIXT 982 lm - 3000K/CRI 80 - 220-240V / 11W - 1364 lm ≠ FIXT 1011 lm - 4000K/CRI 80 - 220-240V

2700K

Non Dimmable

- F025F2BA001 360,00 €
- F025F2BA006 360,00 €
- F025F2BA012 360,00 €
- F025F2BA018 360,00 €
- F025F2BA030 360,00 €
- F025F2BA033 360,00 €

3000K

Non Dimmable

- F025F3BA001 360,00 €
- F025F3BA006 360,00 €
- F025F3BA012 360,00 €
- F025F3BA018 360,00 €
- F025F3BA030 360,00 €
- F025F3BA033 360,00 €

4000K

Non Dimmable

- F025F4BA001 360,00 €
- F025F4BA006 360,00 €
- F025F4BA012 360,00 €
- F025F4BA018 360,00 €
- F025F4BA030 360,00 €
- F025F4BA033 360,00 €

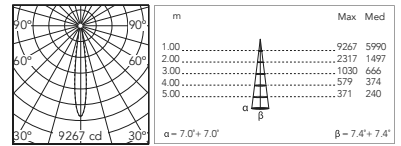

@ 3000K

Optic Medium Flood 33°

CoB Led: 11W - 1247 lm ≠ FIXT 906 lm - 2700K/CRI 80 - 220-240V / 11W - 1325 lm ≠ FIXT 964 lm - 3000K/CRI 80 - 220-240V / 11W - 1364 lm ≠ FIXT 993 lm - 4000K/CRI 80 - 220-240V

2700K

Non Dimmable

- F025F2CA001 360,00 €
- F025F2CA006 360,00 €
- F025F2CA012 360,00 €
- F025F2CA018 360,00 €
- F025F2CA030 360,00 €
- F025F2CA033 360,00 €

3000K

Non Dimmable

- F025F3CA001 360,00 €
- F025F3CA006 360,00 €
- F025F3CA012 360,00 €
- F025F3CA018 360,00 €
- F025F3CA030 360,00 €
- F025F3CA033 360,00 €

4000K

Non Dimmable

- F025F4CA001 360,00 €
- F025F4CA006 360,00 €
- F025F4CA012 360,00 €
- F025F4CA018 360,00 €
- F025F4CA030 360,00 €
- F025F4CA033 360,00 €

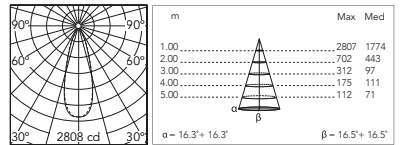

@ 3000K

Spine F 1 / F 2 Absolute: Accessoires / Accessories

Honeycomb	Honeycomb Louvre	Spine F 1 F025Z060000	20,00 €		Ø60
Honeycomb	Honeycomb Louvre	Spine F 2 F026Z060000	21,00 €		Ø80
Gelbox IPX8 pour le raccordement électrique.	Gelbox IPX8 for splicing connectors.	Spine F 1 F990C100000	14,00 €		18, 31, 35
Gelbox IPX8 pour le raccordement électrique.	Gelbox IPX8 for splicing connectors.	Spine F 2 F990C110000	22,00 €		21,5, 41, 50

Spine F 1 / F 2 Absolute: Accessoires pour les versions non dimmables / Accessories for non-dimmable versions

Système de jonction IP68 H2O Stop anti-condensation à 2 voies 4 pôles.	2 way terminal block 4 poles IP68 H2O Stop.	F990C00A000	33,00 €		Ø22, 80
Système de jonction IP68 H2O Stop anti-condensation à 3/4 voies 4 pôles. (Ø5,5÷12mm câble).	3/4 way terminal block 4 poles IP68 H2O Stop. (Ø5,5÷12mm câble).	F990C010000	60,00 €		54, 80

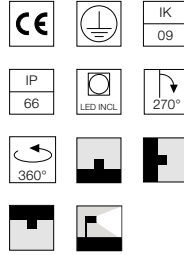
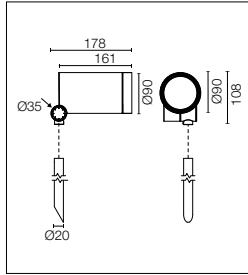

Source LED COB incluse.
Source d'alimentation électrique intégrée 220-240V ON/OFF et réglable 1-10V ou DALI. Équipée d'un câble en néoprène de 5m (10m sur commande) pour une connexion à distance; pour garantir l'étanchéité, il est conseillé d'utiliser des câbles flexibles conçus pour l'extérieur. La tige pour les installations au sol est disponible en deux tailles et doit se commander séparément.

LED COB light source included. Integrated electric power supply 220-240V ON/OFF and adjustable 1-10V or DALI. Equipped with a 5m neoprene cable (10m upon request) for remote connection. To guarantee its water tightness, it is recommended to use flexible cables designed for outdoor use. The rod for ground installations is available in two sizes and needs to be ordered separately.

Optic Spot 22°

CoB Led: 19,5W - 2197 lm ≠ FIXT 1939 lm - 2700K/CRI 80 - 220-240V / 19,5W - 2367 lm ≠ FIXT 2085 lm - 3000K/CRI 80 - 220-240V / 19,5W - 2497 lm ≠ FIXT 2120 lm - 4000K/CRI 80 - 220-240V

2700K Non Dimmable		3000K Non Dimmable		4000K Non Dimmable	
○ F026F2BA001.A	490,00 €	○ F026F3BA001	490,00 €	○ F026F4BA001.A	490,00 €
● F026F2BA006.A	490,00 €	● F026F3BA006	490,00 €	● F026F4BA006.A	490,00 €
● F026F2BA012.A	490,00 €	● F026F3BA012	490,00 €	● F026F4BA012.A	490,00 €
● F026F2BA018.A	490,00 €	● F026F3BA018	490,00 €	● F026F4BA018.A	490,00 €
● F026F2BA030.A	490,00 €	● F026F3BA030	490,00 €	● F026F4BA030.A	490,00 €
● F026F2BA033.A	490,00 €	● F026F3BA033	490,00 €	● F026F4BA033.A	490,00 €
1-10V					
○ F026F2BB001.A	533,00 €	○ F026F3BB001	533,00 €	○ F026F4BB001.A	533,00 €
● F026F2BB006.A	533,00 €	● F026F3BB006	533,00 €	● F026F4BB006.A	533,00 €
● F026F2BB012.A	533,00 €	● F026F3BB012	533,00 €	● F026F4BB012.A	533,00 €
● F026F2BB018.A	533,00 €	● F026F3BB018	533,00 €	● F026F4BB018.A	533,00 €
● F026F2BB030.A	533,00 €	● F026F3BB030	533,00 €	● F026F4BB030.A	533,00 €
● F026F2BB033.A	533,00 €	● F026F3BB033	533,00 €	● F026F4BB033.A	533,00 €
Dali					
○ F026F2BD001.A	533,00 €	○ F026F3BD001	533,00 €	○ F026F4BD001.A	533,00 €
● F026F2BD006.A	533,00 €	● F026F3BD006	533,00 €	● F026F4BD006.A	533,00 €
● F026F2BD012.A	533,00 €	● F026F3BD012	533,00 €	● F026F4BD012.A	533,00 €
● F026F2BD018.A	533,00 €	● F026F3BD018	533,00 €	● F026F4BD018.A	533,00 €
● F026F2BD030.A	533,00 €	● F026F3BD030	533,00 €	● F026F4BD030.A	533,00 €
● F026F2BD033.A	533,00 €	● F026F3BD033	533,00 €	● F026F4BD033.A	533,00 €

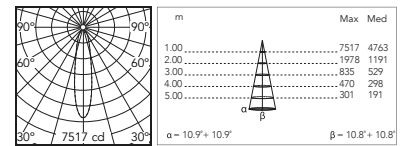

@ 3000K

Optic Medium Flood 43°

CoB Led: 19,5W - 2197 lm ≠ FIXT 2026 lm - 2700K/CRI 80 - 220-240V / 19,5W - 2367 lm ≠ FIXT 2178 lm - 3000K/CRI 80 - 220-240V / 19,5W - 2497 lm ≠ FIXT 2298 lm - 4000K/CRI 80 - 220-240V

2700K Non Dimmable		3000K Non Dimmable		4000K Non Dimmable	
○ F026F2CA001.A	490,00 €	○ F026F3CA001	490,00 €	○ F026F4CA001.A	490,00 €
● F026F2CA006.A	490,00 €	● F026F3CA006	490,00 €	● F026F4CA006.A	490,00 €
● F026F2CA012.A	490,00 €	● F026F3CA012	490,00 €	● F026F4CA012.A	490,00 €
● F026F2CA018.A	490,00 €	● F026F3CA018	490,00 €	● F026F4CA018.A	490,00 €
● F026F2CA030.A	490,00 €	● F026F3CA030	490,00 €	● F026F4CA030.A	490,00 €
● F026F2CA033.A	490,00 €	● F026F3CA033	490,00 €	● F026F4CA033.A	490,00 €
1-10V					
○ F026F2CB001.A	533,00 €	○ F026F3CB001	533,00 €	○ F026F4CB001.A	533,00 €
● F026F2CB006.A	533,00 €	● F026F3CB006	533,00 €	● F026F4CB006.A	533,00 €
● F026F2CB012.A	533,00 €	● F026F3CB012	533,00 €	● F026F4CB012.A	533,00 €
● F026F2CB018.A	533,00 €	● F026F3CB018	533,00 €	● F026F4CB018.A	533,00 €
● F026F2CB030.A	533,00 €	● F026F3CB030	533,00 €	● F026F4CB030.A	533,00 €
● F026F2CB033.A	533,00 €	● F026F3CB033	533,00 €	● F026F4CB033.A	533,00 €
Dali					
○ F026F2CD001.A	533,00 €	○ F026F3CD001	533,00 €	○ F026F4CD001.A	533,00 €
● F026F2CD006.A	533,00 €	● F026F3CD006	533,00 €	● F026F4CD006.A	533,00 €
● F026F2CD012.A	533,00 €	● F026F3CD012	533,00 €	● F026F4CD012.A	533,00 €
● F026F2CD018.A	533,00 €	● F026F3CD018	533,00 €	● F026F4CD018.A	533,00 €
● F026F2CD030.A	533,00 €	● F026F3CD030	533,00 €	● F026F4CD030.A	533,00 €
● F026F2CD033.A	533,00 €	● F026F3CD033	533,00 €	● F026F4CD033.A	533,00 €

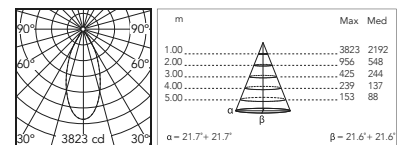

@ 3000K

Spine F 2 Absolute: Accessoires pour les versions dimmables / Accessories for dimmable versions

Kit de connecteurs à 5 pôles: fiche volante + fiche EU IP68. Connector kit 5-pole flying socket + EU plug IP68. F990C080000 48,00 €



Boitier de dérivation 5 pôles 4 voies (câbles 6-14 mm). 4 way junction box 5 poles IP68 (6-14 mm cables). F990C030000 62,00 €



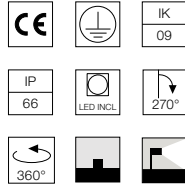
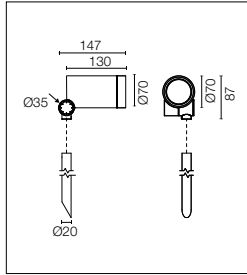

Source Power LED incluse. Équipée d'un snoot intégré pour un plus grand confort visuel: viseur asymétrique disponible en tant qu'accessoire. Les collimateurs sont des accessoires disponibles pour modifier la largeur du faisceau lumineux. Source d'alimentation électrique intégrée 220-240V ON/OFF. Équipée d'un câble en néoprène de 5m (10m sur commande) pour une connexion à distance; pour garantir l'étanchéité, il est conseillé d'utiliser des câbles flexibles conçus pour l'extérieur. La tige pour les installations au sol est disponible en deux tailles et doit se commander séparément. Sur commande, version réglable 1-10V ou DALI avec source d'alimentation à distance 24Vdc.

Power LED source included. Equipped with an integrated snoot for higher visual comfort: the asymmetrical cut visor is available as an accessory. Collimators are available as an accessory to modify the beam opening. Integrated electric power supply 220-240V ON/OFF. Equipped with a 5m neoprene cable (10m upon request) for remote connection. To guarantee its water tightness, it is recommended to use flexible cables designed for outdoor use. The rod for ground installations is available in two sizes and needs to be ordered separately. Upon request: 1-10V or DALI dimmable version with 24Vdc remote power supply.

2200K disponible sur demande.

2200K available on request.

Optic Narrow Spot 7°

Power Led: 3,5W - 168 lm ≠ FIXT 143 lm - 2700K/CRI 80 - 220-240V / 3,5W - 174 lm ≠ FIXT 149 lm - 3000K/CRI 80 - 220-240V / 3,5W - 180 lm ≠ FIXT 154 lm - 4000K/CRI 80 - 220-240V

2700K

Non Dimmable

○ F025L2AA001	522,00 €
● F025L2AA006	522,00 €
● F025L2AA012	522,00 €
● F025L2AA018	522,00 €
● F025L2AA030	522,00 €
● F025L2AA033	522,00 €

3000K

Non Dimmable

○ F025L3AA001	522,00 €
● F025L3AA006	522,00 €
● F025L3AA012	522,00 €
● F025L3AA018	522,00 €
● F025L3AA030	522,00 €
● F025L3AA033	522,00 €

4000K

Non Dimmable

○ F025L4AA001	522,00 €
● F025L4AA006	522,00 €
● F025L4AA012	522,00 €
● F025L4AA018	522,00 €
● F025L4AA030	522,00 €
● F025L4AA033	522,00 €

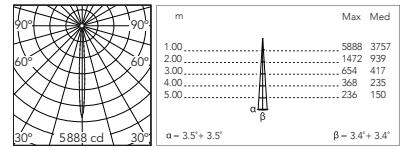

@ 3000K

Optic Spot 14°

Power Led: 7,9W - 671 lm ≠ FIXT 550 lm - 2700K/CRI 80 - 220-240V / 7,9W - 696 lm ≠ FIXT 571 lm - 3000K/CRI 80 - 220-240V / 7,9W - 720 lm ≠ FIXT 591 lm - 4000K/CRI 80 - 220-240V

2700K

Non Dimmable

○ F025L2BA001	522,00 €
● F025L2BA006	522,00 €
● F025L2BA012	522,00 €
● F025L2BA018	522,00 €
● F025L2BA030	522,00 €
● F025L2BA033	522,00 €

3000K

Non Dimmable

○ F025L3BA001	522,00 €
● F025L3BA006	522,00 €
● F025L3BA012	522,00 €
● F025L3BA018	522,00 €
● F025L3BA030	522,00 €
● F025L3BA033	522,00 €

4000K

Non Dimmable

○ F025L4BA001	522,00 €
● F025L4BA006	522,00 €
● F025L4BA012	522,00 €
● F025L4BA018	522,00 €
● F025L4BA030	522,00 €
● F025L4BA033	522,00 €

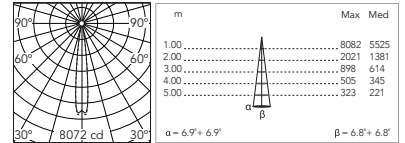

@ 3000K

Optic Medium Flood 24,5°

Power Led: 7,9W - 671 lm ≠ FIXT 499 lm - 2700K/CRI 80 - 220-240V / 7,9W - 696 lm ≠ FIXT 518 lm - 3000K/CRI 80 - 220-240V / 7,9W - 720 lm ≠ FIXT 536 lm - 4000K/CRI 80 - 220-240V

2700K

Non Dimmable

○ F025L2CA001	522,00 €
● F025L2CA006	522,00 €
● F025L2CA012	522,00 €
● F025L2CA018	522,00 €
● F025L2CA030	522,00 €
● F025L2CA033	522,00 €

3000K

Non Dimmable

○ F025L3CA001	522,00 €
● F025L3CA006	522,00 €
● F025L3CA012	522,00 €
● F025L3CA018	522,00 €
● F025L3CA030	522,00 €
● F025L3CA033	522,00 €

4000K

Non Dimmable

○ F025L4CA001	522,00 €
● F025L4CA006	522,00 €
● F025L4CA012	522,00 €
● F025L4CA018	522,00 €
● F025L4CA030	522,00 €
● F025L4CA033	522,00 €

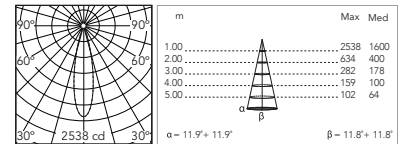

@ 3000K

Optic Flood 32°

Power Led: 7,9W - 671 lm ≠ FIXT 482 lm - 2700K/CRI 80 - 220-240V / 7,9W - 696 lm ≠ FIXT 500 lm - 3000K/CRI 80 - 220-240V / 7,9W - 720 lm ≠ FIXT 518 lm - 4000K/CRI 80 - 220-240V

2700K

Non Dimmable

○ F025L2DA001	522,00 €
● F025L2DA006	522,00 €
● F025L2DA012	522,00 €
● F025L2DA018	522,00 €
● F025L2DA030	522,00 €
● F025L2DA033	522,00 €

3000K

Non Dimmable

○ F025L3DA001	522,00 €
● F025L3DA006	522,00 €
● F025L3DA012	522,00 €
● F025L3DA018	522,00 €
● F025L3DA030	522,00 €
● F025L3DA033	522,00 €

4000K

Non Dimmable

○ F025L4DA001	522,00 €
● F025L4DA006	522,00 €
● F025L4DA012	522,00 €
● F025L4DA018	522,00 €
● F025L4DA030	522,00 €
● F025L4DA033	522,00 €

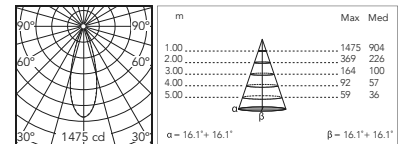

@ 3000K

Optic Wide Flood 49°

Power Led: 7,9W - 671 lm ≠ FIXT 480 lm - 2700K/CRI 80 - 220-240V / 7,9W - 696 lm ≠ FIXT 490 lm - 3000K/CRI 80 - 220-240V / 7,9W - 720 lm ≠ FIXT 505 lm - 4000K/CRI 80 - 220-240V

2700K

Non Dimmable

- F025L2EA001 522,00 €
- F025L2EA006 522,00 €
- F025L2EA012 522,00 €
- F025L2EA018 522,00 €
- F025L2EA030 522,00 €
- F025L2EA033 522,00 €

3000K

Non Dimmable

- F025L3EA001 522,00 €
- F025L3EA006 522,00 €
- F025L3EA012 522,00 €
- F025L3EA018 522,00 €
- F025L3EA030 522,00 €
- F025L3EA033 522,00 €

4000K

Non Dimmable

- F025L4EA001 522,00 €
- F025L4EA006 522,00 €
- F025L4EA012 522,00 €
- F025L4EA018 522,00 €
- F025L4EA030 522,00 €
- F025L4EA033 522,00 €

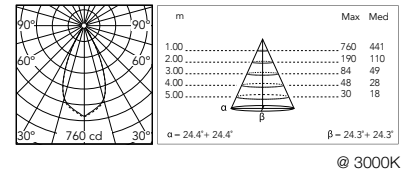

Optic Elliptical 1 13,5° x 50°

Power Led: 7,9W - 671 lm ≠ FIXT 500 lm - 2700K/CRI 80 - 220-240V / 7,9W - 696 lm ≠ FIXT 519 lm - 3000K/CRI 80 - 220-240V / 7,9W - 720 lm ≠ FIXT 537 lm - 4000K/CRI 80 - 220-240V

2700K

Non Dimmable

- F025L2FA001 522,00 €
- F025L2FA006 522,00 €
- F025L2FA012 522,00 €
- F025L2FA018 522,00 €
- F025L2FA030 522,00 €
- F025L2FA033 522,00 €

3000K

Non Dimmable

- F025L3FA001 522,00 €
- F025L3FA006 522,00 €
- F025L3FA012 522,00 €
- F025L3FA018 522,00 €
- F025L3FA030 522,00 €
- F025L3FA033 522,00 €

4000K

Non Dimmable

- F025L4FA001 522,00 €
- F025L4FA006 522,00 €
- F025L4FA012 522,00 €
- F025L4FA018 522,00 €
- F025L4FA030 522,00 €
- F025L4FA033 522,00 €

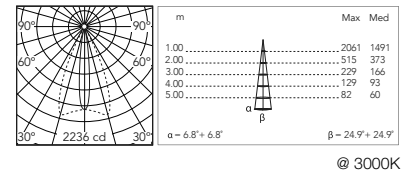

Optic Elliptical 2 26° x 51°

Power Led: 7,9W - 671 lm ≠ FIXT 487 lm - 2700K/CRI 80 - 220-240V / 7,9W - 696 lm ≠ FIXT 505 lm - 3000K/CRI 80 - 220-240V / 7,9W - 720 lm ≠ FIXT 523 lm - 4000K/CRI 80 - 220-240V

2700K

Non Dimmable

- F025L2GA001 522,00 €
- F025L2GA006 522,00 €
- F025L2GA012 522,00 €
- F025L2GA018 522,00 €
- F025L2GA030 522,00 €
- F025L2GA033 522,00 €

3000K

Non Dimmable

- F025L3GA001 522,00 €
- F025L3GA006 522,00 €
- F025L3GA012 522,00 €
- F025L3GA018 522,00 €
- F025L3GA030 522,00 €
- F025L3GA033 522,00 €

4000K

Non Dimmable

- F025L4GA001 522,00 €
- F025L4GA006 522,00 €
- F025L4GA012 522,00 €
- F025L4GA018 522,00 €
- F025L4GA030 522,00 €
- F025L4GA033 522,00 €

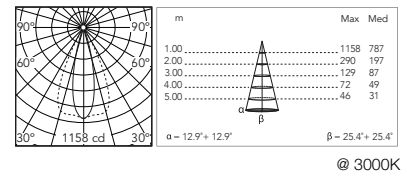

Optic Wall Washer

Power Led: 7,9W - 671 lm ≠ FIXT 471 lm - 2700K/CRI 80 - 220-240V / 7,9W - 696 lm ≠ FIXT 489 lm - 3000K/CRI 80 - 220-240V / 7,9W - 720 lm ≠ FIXT 506 lm - 4000K/CRI 80 - 220-240V

2700K

Non Dimmable

- F025L2HA001 522,00 €
- F025L2HA006 522,00 €
- F025L2HA012 522,00 €
- F025L2HA018 522,00 €
- F025L2HA030 522,00 €
- F025L2HA033 522,00 €

3000K

Non Dimmable

- F025L3HA001 522,00 €
- F025L3HA006 522,00 €
- F025L3HA012 522,00 €
- F025L3HA018 522,00 €
- F025L3HA030 522,00 €
- F025L3HA033 522,00 €

4000K

Non Dimmable

- F025L4HA001 522,00 €
- F025L4HA006 522,00 €
- F025L4HA012 522,00 €
- F025L4HA018 522,00 €
- F025L4HA030 522,00 €
- F025L4HA033 522,00 €

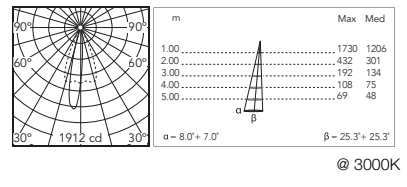

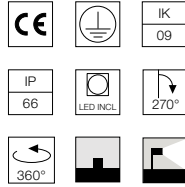
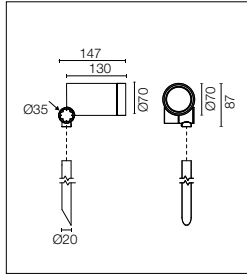

Source LED à basse consommation incluse. Équipée d'un snoot intégré pour un plus grand confort visuel: viseur asymétrique disponible en tant qu'accessoire. Les collimateurs sont des accessoires disponibles pour modifier la largeur du faisceau lumineux. Source d'alimentation électrique intégrée 220-240V ON/OFF. Équipée d'un câble en néoprène de 5m (10m sur commande) pour une connexion à distance; pour garantir l'étanchéité, il est conseillé d'utiliser des câbles flexibles conçus pour l'extérieur. La tige pour les installations au sol est disponible en deux tailles et doit se commander séparément. Sur commande, version réglable 1-10V ou DALI avec source d'alimentation à distance 24Vdc.

Energy-efficient Power LED source included Equipped with an integrated snoot for higher visual comfort: the asymmetrical cut visor is available as an accessory. Collimators are available as an accessory to modify the beam opening. Integrated electric power supply 220-240V ON/OFF. Equipped with a 5m neoprene cable (10m upon request) for remote connection. To guarantee its water tightness, it is recommended to use flexible cables designed for outdoor use. The rod for ground installations is available in two sizes and needs to be ordered separately. Upon request: 1-10V or DALI dimmable version with 24Vdc remote power supply.

Optic Spot 12°

Power Led: 10,5W - 920 lm ≠ FIXT 680 lm - 2700K/CRI 80 - 220-240V / 10,5W - 966 lm ≠ FIXT 706 lm - 3000K/CRI 80 - 220-240V / 10,5W - 1012 lm ≠ FIXT 730 lm - 4000K/CRI 80 - 220-240V

2700K

Non Dimmable

○ F025M2BA001	522,00 €
● F025M2BA006	522,00 €
● F025M2BA012	522,00 €
● F025M2BA018	522,00 €
● F025M2BA030	522,00 €
● F025M2BA033	522,00 €

3000K

Non Dimmable

○ F025M3BA001	522,00 €
● F025M3BA006	522,00 €
● F025M3BA012	522,00 €
● F025M3BA018	522,00 €
● F025M3BA030	522,00 €
● F025M3BA033	522,00 €

4000K

Non Dimmable

○ F025M4BA001	522,00 €
● F025M4BA006	522,00 €
● F025M4BA012	522,00 €
● F025M4BA018	522,00 €
● F025M4BA030	522,00 €
● F025M4BA033	522,00 €

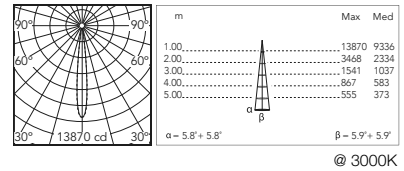

Optic Medium Flood 26,5°

Power Led: 10,5W - 920 lm ≠ FIXT 594 lm - 2700K/CRI 80 - 220-240V / 10,5W - 966 lm ≠ FIXT 630 lm - 3000K/CRI 80 - 220-240V / 10,5W - 1012 lm ≠ FIXT 654 lm - 4000K/CRI 80 - 220-240V

2700K

Non Dimmable

○ F025M2CA001	522,00 €
● F025M2CA006	522,00 €
● F025M2CA012	522,00 €
● F025M2CA018	522,00 €
● F025M2CA030	522,00 €
● F025M2CA033	522,00 €

3000K

Non Dimmable

○ F025M3CA001	522,00 €
● F025M3CA006	522,00 €
● F025M3CA012	522,00 €
● F025M3CA018	522,00 €
● F025M3CA030	522,00 €
● F025M3CA033	522,00 €

4000K

Non Dimmable

○ F025M4CA001	522,00 €
● F025M4CA006	522,00 €
● F025M4CA012	522,00 €
● F025M4CA018	522,00 €
● F025M4CA030	522,00 €
● F025M4CA033	522,00 €

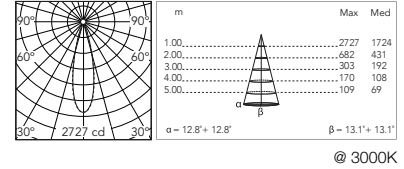

Optic Flood 33,5°

Power Led: 10,5W - 920 lm ≠ FIXT 592 lm - 2700K/CRI 80 - 220-240V / 10,5W - 966 lm ≠ FIXT 627 lm - 3000K/CRI 80 - 220-240V / 10,5W - 1012 lm ≠ FIXT 651 lm - 4000K/CRI 80 - 220-240V

2700K

Non Dimmable

○ F025M2DA001	522,00 €
● F025M2DA006	522,00 €
● F025M2DA012	522,00 €
● F025M2DA018	522,00 €
● F025M2DA030	522,00 €
● F025M2DA033	522,00 €

3000K

Non Dimmable

○ F025M3DA001	522,00 €
● F025M3DA006	522,00 €
● F025M3DA012	522,00 €
● F025M3DA018	522,00 €
● F025M3DA030	522,00 €
● F025M3DA033	522,00 €

4000K

Non Dimmable

○ F025M4DA001	522,00 €
● F025M4DA006	522,00 €
● F025M4DA012	522,00 €
● F025M4DA018	522,00 €
● F025M4DA030	522,00 €
● F025M4DA033	522,00 €

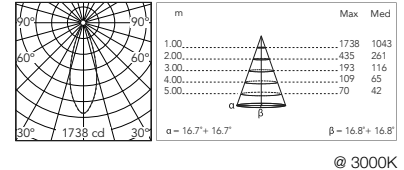

Optic Wide Flood 50°

Power Led: 10,5W - 920 lm ≠ FIXT 591 lm - 2700K/CRI 80 - 220-240V / 10,5W - 966 lm ≠ FIXT 619 lm - 3000K/CRI 80 - 220-240V / 10,5W - 1012 lm ≠ FIXT 650 lm - 4000K/CRI 80 - 220-240V

2700K

Non Dimmable

○ F025M2EA001	522,00 €
● F025M2EA006	522,00 €
● F025M2EA012	522,00 €
● F025M2EA018	522,00 €
● F025M2EA030	522,00 €
● F025M2EA033	522,00 €

3000K

Non Dimmable

○ F025M3EA001	522,00 €
● F025M3EA006	522,00 €
● F025M3EA012	522,00 €
● F025M3EA018	522,00 €
● F025M3EA030	522,00 €
● F025M3EA033	522,00 €

4000K

Non Dimmable

○ F025M4EA001	522,00 €
● F025M4EA006	522,00 €
● F025M4EA012	522,00 €
● F025M4EA018	522,00 €
● F025M4EA030	522,00 €
● F025M4EA033	522,00 €

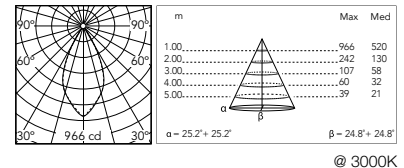

Spine F 1 Pro Hp

Optic Elliptical 1 11,5° x 49°

Power Led: 10,5W - 920 lm ≠ FIXT 603 lm - 2700K/CRI 80 - 220-240V / 10,5W - 966 lm ≠ FIXT 639 lm - 3000K/CRI 80 - 220-240V / 10,5W - 1012 lm ≠ FIXT 663 lm - 4000K/CRI 80 - 220-240V

2700K

Non Dimmable

○ F025M2FA001	522,00 €
● F025M2FA006	522,00 €
● F025M2FA012	522,00 €
● F025M2FA018	522,00 €
● F025M2FA030	522,00 €
● F025M2FA033	522,00 €

3000K

Non Dimmable

○ F025M3FA001	522,00 €
● F025M3FA006	522,00 €
● F025M3FA012	522,00 €
● F025M3FA018	522,00 €
● F025M3FA030	522,00 €
● F025M3FA033	522,00 €

4000K

Non Dimmable

○ F025M4FA001	522,00 €
● F025M4FA006	522,00 €
● F025M4FA012	522,00 €
● F025M4FA018	522,00 €
● F025M4FA030	522,00 €
● F025M4FA033	522,00 €

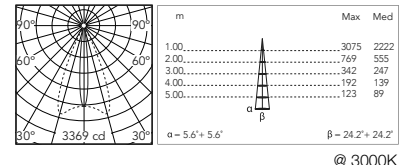

Optic Elliptical 2 25,5° x 50°

Power Led: 10,5W - 920 lm ≠ FIXT 601 lm - 2700K/CRI 80 - 220-240V / 10,5W - 966 lm ≠ FIXT 624 lm - 3000K/CRI 80 - 220-240V / 10,5W - 1012 lm ≠ FIXT 645 lm - 4000K/CRI 80 - 220-240V

2700K

Non Dimmable

○ F025M2GA001	522,00 €
● F025M2GA006	522,00 €
● F025M2GA012	522,00 €
● F025M2GA018	522,00 €
● F025M2GA030	522,00 €
● F025M2GA033	522,00 €

3000K

Non Dimmable

○ F025M3GA001	522,00 €
● F025M3GA006	522,00 €
● F025M3GA012	522,00 €
● F025M3GA018	522,00 €
● F025M3GA030	522,00 €
● F025M3GA033	522,00 €

4000K

Non Dimmable

○ F025M4GA001	522,00 €
● F025M4GA006	522,00 €
● F025M4GA012	522,00 €
● F025M4GA018	522,00 €
● F025M4GA030	522,00 €
● F025M4GA033	522,00 €

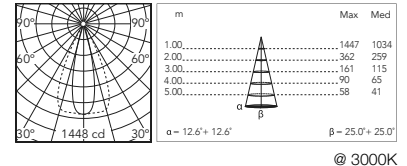

Optic Wall Washer

Power Led: 10,5W - 920 lm ≠ FIXT 574 lm - 2700K/CRI 80 - 220-240V / 10,5W - 966 lm ≠ FIXT 609 lm - 3000K/CRI 80 - 220-240V / 10,5W - 1012 lm ≠ FIXT 631 lm - 4000K/CRI 80 - 220-240V

2700K

Non Dimmable

○ F025M2HA001	522,00 €
● F025M2HA006	522,00 €
● F025M2HA012	522,00 €
● F025M2HA018	522,00 €
● F025M2HA030	522,00 €
● F025M2HA033	522,00 €

3000K

Non Dimmable

○ F025M3HA001	522,00 €
● F025M3HA006	522,00 €
● F025M3HA012	522,00 €
● F025M3HA018	522,00 €
● F025M3HA030	522,00 €
● F025M3HA033	522,00 €

4000K

Non Dimmable

○ F025M4HA001	522,00 €
● F025M4HA006	522,00 €
● F025M4HA012	522,00 €
● F025M4HA018	522,00 €
● F025M4HA030	522,00 €
● F025M4HA033	522,00 €

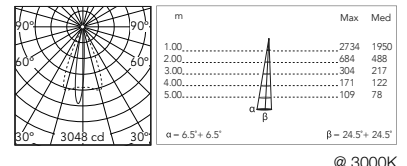

Spine F 1 Pro: Accessoires / Accessories

Honeycomb	Honeycomb Louvre	F025Z060000	20,00 €		
Gelbox IPX8 pour le raccordement électrique.	Gelbox IPX8 for splicing connectors.	F990C100000	14,00 €		
Lentilles de conversion / Converter lenses:					
- Converter Spine 0 / Spine 1 Optic Medium Flood		F029Z010000	35,00 €		
- Converter Spine 0 / Spine 1 Optic Flood		F029Z011000	35,00 €		
- Converter Spine 0 / Spine 1 Optic Wide Flood		F029Z012000	35,00 €		
- Converter Spine 0 / Spine 1 Optic Elliptic 1		F029Z013000	35,00 €		
- Converter Spine 0 / Spine 1 Optic Elliptic 2		F029Z014000	35,00 €		
- Converter Spine 0 / Spine 1 Optic Wall Washer		F029Z015000	35,00 €		
Système de jonction IP68 H2O Stop anti-condensation à 2 voies 4 pôles.	2 way terminal block 4 poles IP68 H2O Stop.	F990C00A000	33,00 €		
Système de jonction IP68 H2O Stop anti-condensation à 3/4 voies 4 pôles. (Ø5,5÷12mm câble).	3/4 way terminal block 4 poles IP68 H2O Stop. (Ø5,5÷12mm cable).	F990C010000	60,00 €		

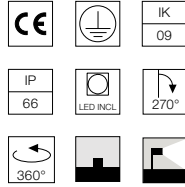
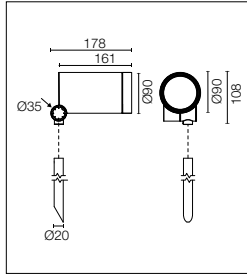

Source Power LED incluse. Équipée d'un snoot intégré pour un plus grand confort visuel. Les collimateurs sont des accessoires disponibles pour modifier la largeur du faisceau lumineux. Source d'alimentation électrique intégrée 220-240V ON/OFF et réglable 1-10V ou DALI. Équipée d'un câble en néoprène de 5m (10m sur commande) pour une connexion à distance; pour garantir l'étanchéité, il est conseillé d'utiliser des câbles flexibles conçus pour l'extérieur. La tige pour les installations au sol est disponible en deux tailles et doit se commander séparément.

Power LED source included. Equipped with an integrated snoot for higher visual comfort. Collimators are available as an accessory to modify the beam opening. Integrated electric power supply 220-240V ON/OFF and adjustable 1-10V or DALI. Equipped with a 5m neoprene cable (10m upon request) for remote connection. To guarantee its water tightness, it is recommended to use flexible cables designed for outdoor use. The rod for ground installations is available in two sizes and needs to be ordered separately.

Optic Narrow Spot
2200K disponible sur demande.

Optic Narrow Spot
2200K available on request.

Optic Narrow Spot 6°

Power Led: 4,1W - 248 lm ≠ FIXT 230 lm - 2700K/CRI 80 - 220-240V / 4,1W - 258 lm ≠ FIXT 239 lm - 3000K/CRI 80 - 220-240V / 4,1W - 267 lm ≠ FIXT 247 lm - 4000K/CRI 80 - 220-240V

2700K

Non Dimmable

- F026L2AA001 642,00 €
- F026L2AA006 642,00 €
- F026L2AA012 642,00 €
- F026L2AA018 642,00 €
- F026L2AA030 642,00 €
- F026L2AA033 642,00 €
- 1-10V
- F026L2AB001 689,00 €
- F026L2AB006 689,00 €
- F026L2AB012 689,00 €
- F026L2AB018 689,00 €
- F026L2AB030 689,00 €
- F026L2AB033 689,00 €
- Dali
- F026L2AD001 689,00 €
- F026L2AD006 689,00 €
- F026L2AD012 689,00 €
- F026L2AD018 689,00 €
- F026L2AD030 689,00 €
- F026L2AD033 689,00 €

3000K

Non Dimmable

- F026L3AA001 642,00 €
- F026L3AA006 642,00 €
- F026L3AA012 642,00 €
- F026L3AA018 642,00 €
- F026L3AA030 642,00 €
- F026L3AA033 642,00 €
- 1-10V
- F026L3AB001 689,00 €
- F026L3AB006 689,00 €
- F026L3AB012 689,00 €
- F026L3AB018 689,00 €
- F026L3AB030 689,00 €
- F026L3AB033 689,00 €
- Dali
- F026L3AD001 689,00 €
- F026L3AD006 689,00 €
- F026L3AD012 689,00 €
- F026L3AD018 689,00 €
- F026L3AD030 689,00 €
- F026L3AD033 689,00 €

4000K

Non Dimmable

- F026L4AA001 642,00 €
- F026L4AA006 642,00 €
- F026L4AA012 642,00 €
- F026L4AA018 642,00 €
- F026L4AA030 642,00 €
- F026L4AA033 642,00 €
- 1-10V
- F026L4AB001 689,00 €
- F026L4AB006 689,00 €
- F026L4AB012 689,00 €
- F026L4AB018 689,00 €
- F026L4AB030 689,00 €
- F026L4AB033 689,00 €
- Dali
- F026L4AD001 689,00 €
- F026L4AD006 689,00 €
- F026L4AD012 689,00 €
- F026L4AD018 689,00 €
- F026L4AD030 689,00 €
- F026L4AD033 689,00 €

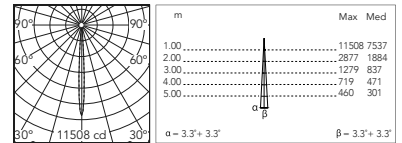

@ 3000K

Optic Spot 9,5°

Power Led: 10,5W - 920 lm ≠ FIXT 769 lm - 2700K/CRI 80 - 220-240V / 10,5W - 966 lm ≠ FIXT 808 lm - 3000K/CRI 80 - 220-240V / 10,5W - 1012 lm ≠ FIXT 846 lm - 4000K/CRI 80 - 220-240V

2700K

Non Dimmable

- F026L2BA001 642,00 €
- F026L2BA006 642,00 €
- F026L2BA012 642,00 €
- F026L2BA018 642,00 €
- F026L2BA030 642,00 €
- F026L2BA033 642,00 €
- 1-10V
- F026L2BB001 689,00 €
- F026L2BB006 689,00 €
- F026L2BB012 689,00 €
- F026L2BB018 689,00 €
- F026L2BB030 689,00 €
- F026L2BB033 689,00 €
- Dali
- F026L2BD001 689,00 €
- F026L2BD006 689,00 €
- F026L2BD012 689,00 €
- F026L2BD018 689,00 €
- F026L2BD030 689,00 €
- F026L2BD033 689,00 €

3000K

Non Dimmable

- F026L3BA001 642,00 €
- F026L3BA006 642,00 €
- F026L3BA012 642,00 €
- F026L3BA018 642,00 €
- F026L3BA030 642,00 €
- F026L3BA033 642,00 €
- 1-10V
- F026L3BB001 689,00 €
- F026L3BB006 689,00 €
- F026L3BB012 689,00 €
- F026L3BB018 689,00 €
- F026L3BB030 689,00 €
- F026L3BB033 689,00 €
- Dali
- F026L3BD001 689,00 €
- F026L3BD006 689,00 €
- F026L3BD012 689,00 €
- F026L3BD018 689,00 €
- F026L3BD030 689,00 €
- F026L3BD033 689,00 €

4000K

Non Dimmable

- F026L4BA001 642,00 €
- F026L4BA006 642,00 €
- F026L4BA012 642,00 €
- F026L4BA018 642,00 €
- F026L4BA030 642,00 €
- F026L4BA033 642,00 €
- 1-10V
- F026L4BB001 689,00 €
- F026L4BB006 689,00 €
- F026L4BB012 689,00 €
- F026L4BB018 689,00 €
- F026L4BB030 689,00 €
- F026L4BB033 689,00 €
- Dali
- F026L4BD001 689,00 €
- F026L4BD006 689,00 €
- F026L4BD012 689,00 €
- F026L4BD018 689,00 €
- F026L4BD030 689,00 €
- F026L4BD033 689,00 €

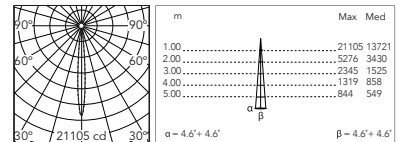

@ 3000K

Optic Elliptical 1 9,5° x 48°

Power Led: 10,5W - 920 lm ≠ FIXT 717 lm - 2700K/CRI 80 - 220-240V / 10,5W - 966 lm ≠ FIXT 744 lm - 3000K/CRI 80 - 220-240V / 10,5W - 1012 lm ≠ FIXT 770 lm - 4000K/CRI 80 - 220-240V

2700K		3000K		4000K	
Non Dimmable		Non Dimmable		Non Dimmable	
○ F026L2FA001	642,00 €	○ F026L3FA001	642,00 €	○ F026L4FA001	642,00 €
● F026L2FA006	642,00 €	● F026L3FA006	642,00 €	● F026L4FA006	642,00 €
● F026L2FA012	642,00 €	● F026L3FA012	642,00 €	● F026L4FA012	642,00 €
● F026L2FA018	642,00 €	● F026L3FA018	642,00 €	● F026L4FA018	642,00 €
● F026L2FA030	642,00 €	● F026L3FA030	642,00 €	● F026L4FA030	642,00 €
● F026L2FA033	642,00 €	● F026L3FA033	642,00 €	● F026L4FA033	642,00 €
1-10V					
○ F026L2FB001	689,00 €	○ F026L3FB001	689,00 €	○ F026L4FB001	689,00 €
● F026L2FB006	689,00 €	● F026L3FB006	689,00 €	● F026L4FB006	689,00 €
● F026L2FB012	689,00 €	● F026L3FB012	689,00 €	● F026L4FB012	689,00 €
● F026L2FB018	689,00 €	● F026L3FB018	689,00 €	● F026L4FB018	689,00 €
● F026L2FB030	689,00 €	● F026L3FB030	689,00 €	● F026L4FB030	689,00 €
● F026L2FB033	689,00 €	● F026L3FB033	689,00 €	● F026L4FB033	689,00 €
Dali					
○ F026L2FD001	689,00 €	○ F026L3FD001	689,00 €	○ F026L4FD001	689,00 €
● F026L2FD006	689,00 €	● F026L3FD006	689,00 €	● F026L4FD006	689,00 €
● F026L2FD012	689,00 €	● F026L3FD012	689,00 €	● F026L4FD012	689,00 €
● F026L2FD018	689,00 €	● F026L3FD018	689,00 €	● F026L4FD018	689,00 €
● F026L2FD030	689,00 €	● F026L3FD030	689,00 €	● F026L4FD030	689,00 €
● F026L2FD033	689,00 €	● F026L3FD033	689,00 €	● F026L4FD033	689,00 €

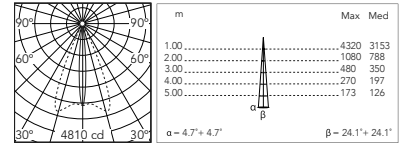

@ 3000K

Optic Elliptical 2 24° x 50°

Power Led: 10,5W - 920 lm ≠ FIXT 699 lm - 2700K/CRI 80 - 220-240V / 10,5W - 966 lm ≠ FIXT 725 lm - 3000K/CRI 80 - 220-240V / 10,5W - 1012 lm ≠ FIXT 750 lm - 4000K/CRI 80 - 220-240V

2700K		3000K		4000K	
Non Dimmable		Non Dimmable		Non Dimmable	
○ F026L2GA001	642,00 €	○ F026L3GA001	642,00 €	○ F026L4GA001	642,00 €
● F026L2GA006	642,00 €	● F026L3GA006	642,00 €	● F026L4GA006	642,00 €
● F026L2GA012	642,00 €	● F026L3GA012	642,00 €	● F026L4GA012	642,00 €
● F026L2GA018	642,00 €	● F026L3GA018	642,00 €	● F026L4GA018	642,00 €
● F026L2GA030	642,00 €	● F026L3GA030	642,00 €	● F026L4GA030	642,00 €
● F026L2GA033	642,00 €	● F026L3GA033	642,00 €	● F026L4GA033	642,00 €
1-10V					
○ F026L2GB001	689,00 €	○ F026L3GB001	689,00 €	○ F026L4GB001	689,00 €
● F026L2GB006	689,00 €	● F026L3GB006	689,00 €	● F026L4GB006	689,00 €
● F026L2GB012	689,00 €	● F026L3GB012	689,00 €	● F026L4GB012	689,00 €
● F026L2GB018	689,00 €	● F026L3GB018	689,00 €	● F026L4GB018	689,00 €
● F026L2GB030	689,00 €	● F026L3GB030	689,00 €	● F026L4GB030	689,00 €
● F026L2GB033	689,00 €	● F026L3GB033	689,00 €	● F026L4GB033	689,00 €
Dali					
○ F026L2GD001	689,00 €	○ F026L3GD001	689,00 €	○ F026L4GD001	689,00 €
● F026L2GD006	689,00 €	● F026L3GD006	689,00 €	● F026L4GD006	689,00 €
● F026L2GD012	689,00 €	● F026L3GD012	689,00 €	● F026L4GD012	689,00 €
● F026L2GD018	689,00 €	● F026L3GD018	689,00 €	● F026L4GD018	689,00 €
● F026L2GD030	689,00 €	● F026L3GD030	689,00 €	● F026L4GD030	689,00 €
● F026L2GD033	689,00 €	● F026L3GD033	689,00 €	● F026L4GD033	689,00 €

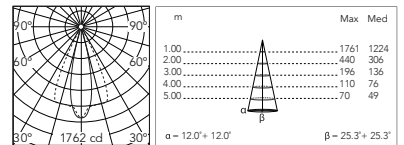

@ 3000K

Optic Wall Washer

Power Led: 10,5W - 920 lm ≠ FIXT 673 lm - 2700K/CRI 80 - 220-240V / 10,5W - 966 lm ≠ FIXT 698 lm - 3000K/CRI 80 - 220-240V / 10,5W - 1012 lm ≠ FIXT 672 lm - 4000K/CRI 80 - 220-240V

2700K		3000K		4000K	
Non Dimmable		Non Dimmable		Non Dimmable	
○ F026L2HA001	642,00 €	○ F026L3HA001	642,00 €	○ F026L4HA001	642,00 €
● F026L2HA006	642,00 €	● F026L3HA006	642,00 €	● F026L4HA006	642,00 €
● F026L2HA012	642,00 €	● F026L3HA012	642,00 €	● F026L4HA012	642,00 €
● F026L2HA018	642,00 €	● F026L3HA018	642,00 €	● F026L4HA018	642,00 €
● F026L2HA030	642,00 €	● F026L3HA030	642,00 €	● F026L4HA030	642,00 €
● F026L2HA033	642,00 €	● F026L3HA033	642,00 €	● F026L4HA033	642,00 €
1-10V					
○ F026L2HB001	689,00 €	○ F026L3HB001	689,00 €	○ F026L4HB001	689,00 €
● F026L2HB006	689,00 €	● F026L3HB006	689,00 €	● F026L4HB006	689,00 €
● F026L2HB012	689,00 €	● F026L3HB012	689,00 €	● F026L4HB012	689,00 €
● F026L2HB018	689,00 €	● F026L3HB018	689,00 €	● F026L4HB018	689,00 €
● F026L2HB030	689,00 €	● F026L3HB030	689,00 €	● F026L4HB030	689,00 €
● F026L2HB033	689,00 €	● F026L3HB033	689,00 €	● F026L4HB033	689,00 €
Dali					
○ F026L2HD001	689,00 €	○ F026L3HD001	689,00 €	○ F026L4HD001	689,00 €
● F026L2HD006	689,00 €	● F026L3HD006	689,00 €	● F026L4HD006	689,00 €
● F026L2HD012	689,00 €	● F026L3HD012	689,00 €	● F026L4HD012	689,00 €
● F026L2HD018	689,00 €	● F026L3HD018	689,00 €	● F026L4HD018	689,00 €
● F026L2HD030	689,00 €	● F026L3HD030	689,00 €	● F026L4HD030	689,00 €
● F026L2HD033	689,00 €	● F026L3HD033	689,00 €	● F026L4HD033	689,00 €

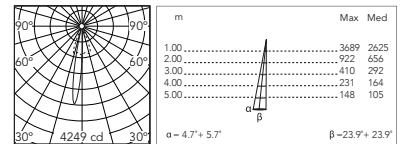

@ 3000K

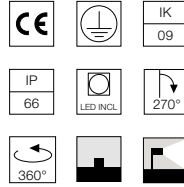
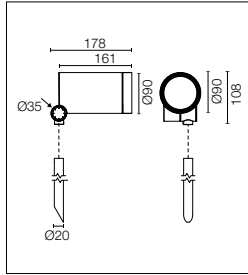

Source LED à basse consommation incluse. Équipée d'un snoot intégré pour un plus grand confort visuel. Les collimateurs sont des accessoires disponibles pour modifier la largeur du faisceau lumineux. Source d'alimentation électrique intégrée 220-240V ON/OFF et réglable 1-10V ou DALI. Équipée d'un câble en néoprène de 5m (10m sur commande) pour une connexion à distance; pour garantir l'étanchéité, il est conseillé d'utiliser des câbles flexibles conçus pour l'extérieur. La tige pour les installations au sol est disponible en deux tailles et doit se commander séparément.

Energy-efficient Power LED source included Equipped with an integrated snoot for higher visual comfort. Collimators are available as an accessory to modify the beam opening. Integrated electric power supply 220-240V ON/OFF and adjustable 1-10V or DALI. Equipped with a 5m neoprene cable (10m upon request) for remote connection. To guarantee its water tightness, it is recommended to use flexible cables designed for outdoor use. The rod for ground installations is available in two sizes and needs to be ordered separately.

2200K disponible sur demande.

2200K available on request.

Optic Spot 14,5°

Power Led: 17W - 1739 lm ≠ FIXT 1443 lm - 2700K/CRI 80 - 220-240V / 17W - 1803 lm ≠ FIXT 1497 lm - 3000K/CRI 80 - 220-240V / 17W - 1868 lm ≠ FIXT 1548 lm - 4000K/CRI 80 - 220-240V

2700K

Non Dimmable

- F026M2BA001 642,00 €
- F026M2BA006 642,00 €
- F026M2BA012 642,00 €
- F026M2BA018 642,00 €
- F026M2BA030 642,00 €
- F026M2BA033 642,00 €
- 1-10V
- F026M2BB001 689,00 €
- F026M2BB006 689,00 €
- F026M2BB012 689,00 €
- F026M2BB018 689,00 €
- F026M2BB030 689,00 €
- F026M2BB033 689,00 €
- Dali
- F026M2BD001 689,00 €
- F026M2BD006 689,00 €
- F026M2BD012 689,00 €
- F026M2BD018 689,00 €
- F026M2BD030 689,00 €
- F026M2BD033 689,00 €

3000K

Non Dimmable

- F026M3BA001 642,00 €
- F026M3BA006 642,00 €
- F026M3BA012 642,00 €
- F026M3BA018 642,00 €
- F026M3BA030 642,00 €
- F026M3BA033 642,00 €
- 1-10V
- F026M3BB001 689,00 €
- F026M3BB006 689,00 €
- F026M3BB012 689,00 €
- F026M3BB018 689,00 €
- F026M3BB030 689,00 €
- F026M3BB033 689,00 €
- Dali
- F026M3BD001 689,00 €
- F026M3BD006 689,00 €
- F026M3BD012 689,00 €
- F026M3BD018 689,00 €
- F026M3BD030 689,00 €
- F026M3BD033 689,00 €

4000K

Non Dimmable

- F026M4BA001 642,00 €
- F026M4BA006 642,00 €
- F026M4BA012 642,00 €
- F026M4BA018 642,00 €
- F026M4BA030 642,00 €
- F026M4BA033 642,00 €
- 1-10V
- F026M4BB001 689,00 €
- F026M4BB006 689,00 €
- F026M4BB012 689,00 €
- F026M4BB018 689,00 €
- F026M4BB030 689,00 €
- F026M4BB033 689,00 €
- Dali
- F026M4BD001 689,00 €
- F026M4BD006 689,00 €
- F026M4BD012 689,00 €
- F026M4BD018 689,00 €
- F026M4BD030 689,00 €
- F026M4BD033 689,00 €

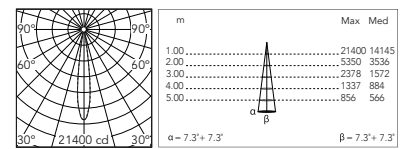

@ 3000K

Optic Medium Flood 26°

Power Led: 17W - 1739 lm ≠ FIXT 1336 lm - 2700K/CRI 80 - 220-240V / 17W - 1803 lm ≠ FIXT 1386 lm - 3000K/CRI 80 - 220-240V / 17W - 1868 lm ≠ FIXT 1434 lm - 4000K/CRI 80 - 220-240V

2700K

Non Dimmable

- F026M2CA001 642,00 €
- F026M2CA006 642,00 €
- F026M2CA012 642,00 €
- F026M2CA018 642,00 €
- F026M2CA030 642,00 €
- F026M2CA033 642,00 €
- 1-10V
- F026M2CB001 689,00 €
- F026M2CB006 689,00 €
- F026M2CB012 689,00 €
- F026M2CB018 689,00 €
- F026M2CB030 689,00 €
- F026M2CB033 689,00 €
- Dali
- F026M2CD001 689,00 €
- F026M2CD006 689,00 €
- F026M2CD012 689,00 €
- F026M2CD018 689,00 €
- F026M2CD030 689,00 €
- F026M2CD033 689,00 €

3000K

Non Dimmable

- F026M3CA001 642,00 €
- F026M3CA006 642,00 €
- F026M3CA012 642,00 €
- F026M3CA018 642,00 €
- F026M3CA030 642,00 €
- F026M3CA033 642,00 €
- 1-10V
- F026M3CB001 689,00 €
- F026M3CB006 689,00 €
- F026M3CB012 689,00 €
- F026M3CB018 689,00 €
- F026M3CB030 689,00 €
- F026M3CB033 689,00 €
- Dali
- F026M3CD001 689,00 €
- F026M3CD006 689,00 €
- F026M3CD012 689,00 €
- F026M3CD018 689,00 €
- F026M3CD030 689,00 €
- F026M3CD033 689,00 €

4000K

Non Dimmable

- F026M4CA001 642,00 €
- F026M4CA006 642,00 €
- F026M4CA012 642,00 €
- F026M4CA018 642,00 €
- F026M4CA030 642,00 €
- F026M4CA033 642,00 €
- 1-10V
- F026M4CB001 689,00 €
- F026M4CB006 689,00 €
- F026M4CB012 689,00 €
- F026M4CB018 689,00 €
- F026M4CB030 689,00 €
- F026M4CB033 689,00 €
- Dali
- F026M4CD001 689,00 €
- F026M4CD006 689,00 €
- F026M4CD012 689,00 €
- F026M4CD018 689,00 €
- F026M4CD030 689,00 €
- F026M4CD033 689,00 €

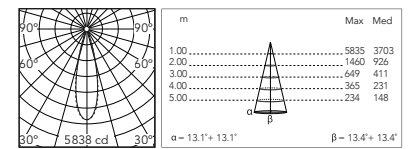

@ 3000K

Optic Elliptical 2 25° x 52°

Power Led: 17W - 1739 lm ≠ FIXT 1298 lm - 2700K/CRI 80 - 220-240V / 17W - 1803 lm ≠ FIXT 1351 lm - 3000K/CRI 80 - 220-240V / 17W - 1868 lm ≠ FIXT 1393 lm - 4000K/CRI 80 - 220-240V

2700K

Non Dimmable

- F026M2GA001 642,00 €
- F026M2GA006 642,00 €
- F026M2GA012 642,00 €
- F026M2GA018 642,00 €
- F026M2GA030 642,00 €
- F026M2GA033 642,00 €

1-10V

- F026M2GB001 689,00 €
- F026M2GB006 689,00 €
- F026M2GB012 689,00 €
- F026M2GB018 689,00 €
- F026M2GB030 689,00 €
- F026M2GB033 689,00 €

Dali

- F026M2GD001 689,00 €
- F026M2GD006 689,00 €
- F026M2GD012 689,00 €
- F026M2GD018 689,00 €
- F026M2GD030 689,00 €
- F026M2GD033 689,00 €

3000K

Non Dimmable

- F026M3GA001 642,00 €
- F026M3GA006 642,00 €
- F026M3GA012 642,00 €
- F026M3GA018 642,00 €
- F026M3GA030 642,00 €
- F026M3GA033 642,00 €

1-10V

- F026M3GB001 689,00 €
- F026M3GB006 689,00 €
- F026M3GB012 689,00 €
- F026M3GB018 689,00 €
- F026M3GB030 689,00 €
- F026M3GB033 689,00 €

Dali

- F026M3GD001 689,00 €
- F026M3GD006 689,00 €
- F026M3GD012 689,00 €
- F026M3GD018 689,00 €
- F026M3GD030 689,00 €
- F026M3GD033 689,00 €

4000K

Non Dimmable

- F026M4GA001 642,00 €
- F026M4GA006 642,00 €
- F026M4GA012 642,00 €
- F026M4GA018 642,00 €
- F026M4GA030 642,00 €
- F026M4GA033 642,00 €

1-10V

- F026M4GB001 689,00 €
- F026M4GB006 689,00 €
- F026M4GB012 689,00 €
- F026M4GB018 689,00 €
- F026M4GB030 689,00 €
- F026M4GB033 689,00 €

Dali

- F026M4GD001 689,00 €
- F026M4GD006 689,00 €
- F026M4GD012 689,00 €
- F026M4GD018 689,00 €
- F026M4GD030 689,00 €
- F026M4GD033 689,00 €

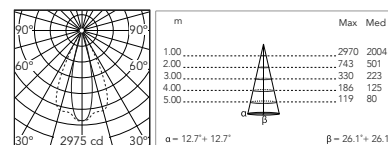

@ 3000K

Optic Wall Washer

Power Led: 17W - 1739 lm ≠ FIXT 1277 lm - 2700K/CRI 80 - 220-240V / 17W - 1803 lm ≠ FIXT 1325 lm - 3000K/CRI 80 - 220-240V / 17W - 1868 lm ≠ FIXT 1370 lm - 4000K/CRI 80 - 220-240V

2700K

Non Dimmable

- F026M2HA001 642,00 €
- F026M2HA006 642,00 €
- F026M2HA012 642,00 €
- F026M2HA018 642,00 €
- F026M2HA030 642,00 €
- F026M2HA033 642,00 €

1-10V

- F026M2HB001 689,00 €
- F026M2HB006 689,00 €
- F026M2HB012 689,00 €
- F026M2HB018 689,00 €
- F026M2HB030 689,00 €
- F026M2HB033 689,00 €

Dali

- F026M2HD001 689,00 €
- F026M2HD006 689,00 €
- F026M2HD012 689,00 €
- F026M2HD018 689,00 €
- F026M2HD030 689,00 €
- F026M2HD033 689,00 €

3000K

Non Dimmable

- F026M3HA001 642,00 €
- F026M3HA006 642,00 €
- F026M3HA012 642,00 €
- F026M3HA018 642,00 €
- F026M3HA030 642,00 €
- F026M3HA033 642,00 €

1-10V

- F026M3HB001 689,00 €
- F026M3HB006 689,00 €
- F026M3HB012 689,00 €
- F026M3HB018 689,00 €
- F026M3HB030 689,00 €
- F026M3HB033 689,00 €

Dali

- F026M3HD001 689,00 €
- F026M3HD006 689,00 €
- F026M3HD012 689,00 €
- F026M3HD018 689,00 €
- F026M3HD030 689,00 €
- F026M3HD033 689,00 €

4000K

Non Dimmable

- F026M4HA001 642,00 €
- F026M4HA006 642,00 €
- F026M4HA012 642,00 €
- F026M4HA018 642,00 €
- F026M4HA030 642,00 €
- F026M4HA033 642,00 €

1-10V

- F026M4HB001 689,00 €
- F026M4HB006 689,00 €
- F026M4HB012 689,00 €
- F026M4HB018 689,00 €
- F026M4HB030 689,00 €
- F026M4HB033 689,00 €





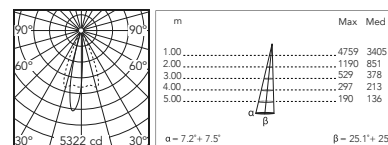



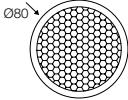
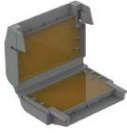
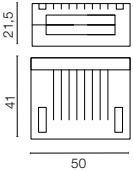

Dali

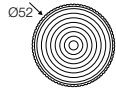
- F026M4HD001 689,00 €
- F026M4HD006 689,00 €
- F026M4HD012 689,00 €
- F026M4HD018 689,00 €
- F026M4HD030 689,00 €
- F026M4HD033 689,00 €

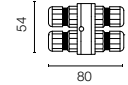

@ 3000K

Spine F 2 Pro: Accessoires / Accessories

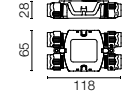
Honeycomb	Honeycomb Louvre	F026Z060000	21,00 €		
Gelbox IPX8 pour le raccordement électrique.	Gelbox IPX8 for splicing connectors.	F990C110000	22,00 €		
Lentilles de conversion / Converter lenses:					
- Converter Spine 2 Optic Medium Flood		F029Z020000	37,00 €		
- Converter Spine 2 Optic Flood		F029Z021000	37,00 €		
- Converter Spine 2 Optic Wide Flood		F029Z022000	37,00 €		
- Converter Spine 2 Optic Elliptic 1		F029Z023000	37,00 €		
- Converter Spine 2 Optic Elliptic 2		F029Z024000	37,00 €		
- Converter Spine 2 Optic Wall Washer		F029Z025000	37,00 €		
Système de jonction IP68 H2O Stop anti-condensation à 2 voies 4 pôles.	2 way terminal block 4 poles IP68 H2O Stop.	F990C00A000	33,00 €		
Système de jonction IP68 H2O Stop anti-condensation à 3/4 voies 4 pôles. (Ø5,5÷12mm câble).	3/4 way terminal block 4 poles IP68 H2O Stop. (ø5,5÷12mm câble).	F990C010000	60,00 €		
Kit de connecteurs à 5 pôles: fiche volante + fiche EU IP68.	Connector kit 5-pole flying socket + EU plug IP68.	F990C080000	48,00 €		
Boitier de dérivation 5 pôles 4 voies (câbles 6-14 mm).	4 way junction box 5 poles IP68 (6-14 mm cables).	F990C030000	62,00 €		

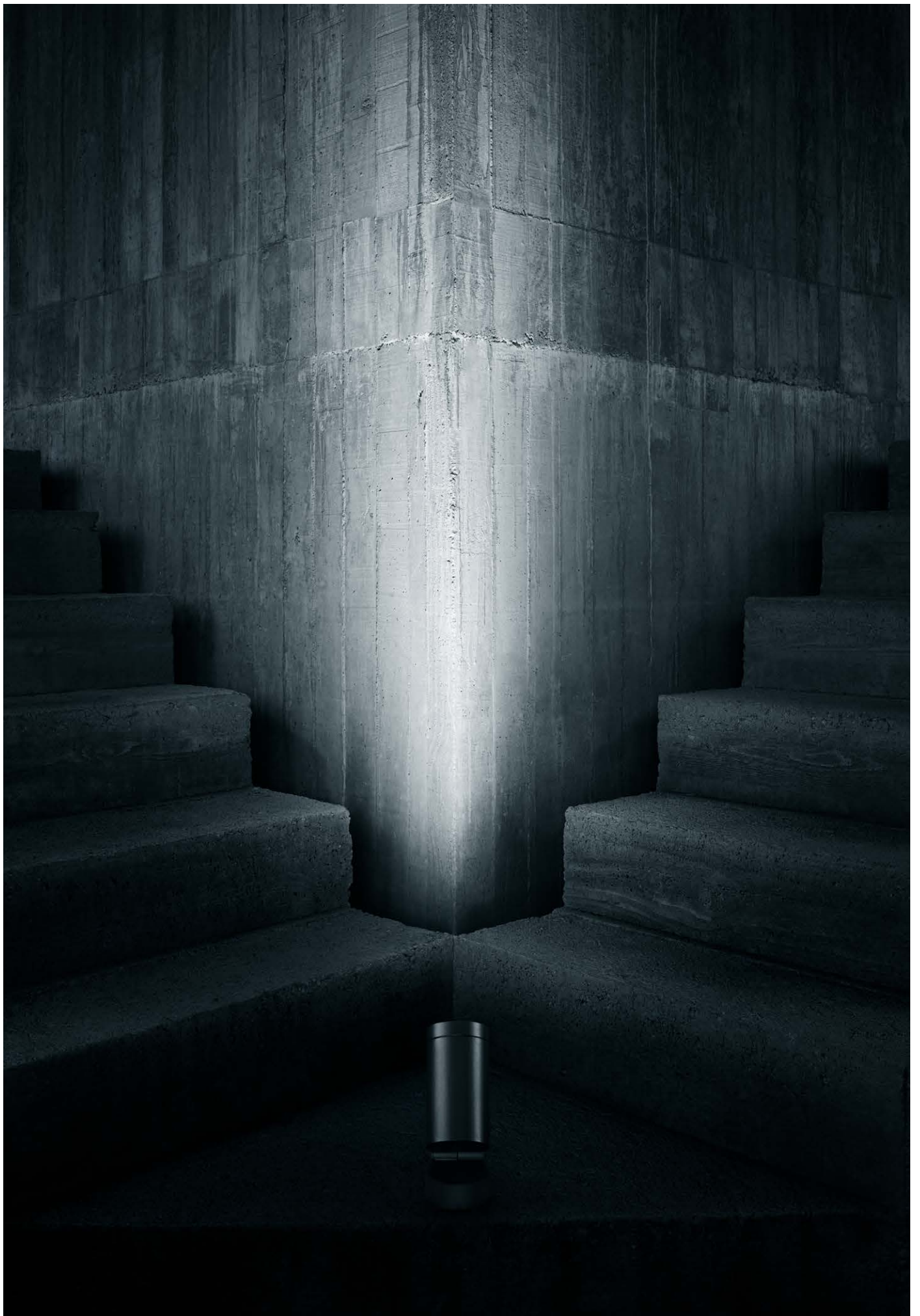

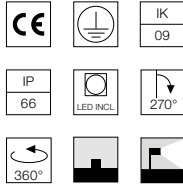
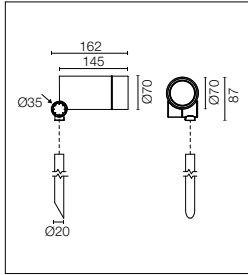

Source Power LED incluse. Équipée d'un snoot intégré pour un plus grand confort visuel: viseur asymétrique disponible en tant qu'accessoire. Les collimateurs sont des accessoires disponibles pour modifier la largeur du faisceau lumineux. Source d'alimentation électrique intégrée 220-240V ON/OFF. Équipée d'un câble en néoprène de 5m (10m sur commande) pour une connexion à distance; pour garantir l'étanchéité, il est conseillé d'utiliser des câbles flexibles conçus pour l'extérieur. La tige pour les installations au sol est disponible en deux tailles et doit se commander séparément. Sur commande, version réglable 1-10V ou DALI avec source d'alimentation à distance 24Vdc.

Power LED source included. Equipped with an integrated snoot for higher visual comfort: the asymmetrical cut visor is available as an accessory. Collimators are available as an accessory to modify the beam opening. Integrated electric power supply 220-240V ON/OFF. Equipped with a 5m neoprene cable (10m upon request) for remote connection. To guarantee its water tightness, it is recommended to use flexible cables designed for outdoor use. The rod for ground installations is available in two sizes and needs to be ordered separately. Upon request: 1-10V or DALI dimmable version with 24Vdc remote power supply.

2200K disponible sur demande.

2200K available on request.

Optic Narrow Spot 7°

Power Led: 3,5W - 168 lm ≠ FIXT 143 lm - 2700K/CRI 80 - 220-240V / 3,5W - 174 lm ≠ FIXT 149 lm - 3000K/CRI 80 - 220-240V / 3,5W - 180 lm ≠ FIXT 154 lm - 4000K/CRI 80 - 220-240V

2700K

Non Dimmable

○ F025G2AA001	538,00 €
● F025G2AA006	538,00 €
● F025G2AA012	538,00 €
● F025G2AA018	538,00 €
● F025G2AA030	538,00 €
● F025G2AA033	538,00 €

3000K

Non Dimmable

○ F025G3AA001	538,00 €
● F025G3AA006	538,00 €
● F025G3AA012	538,00 €
● F025G3AA018	538,00 €
● F025G3AA030	538,00 €
● F025G3AA033	538,00 €

4000K

Non Dimmable

○ F025G4AA001	538,00 €
● F025G4AA006	538,00 €
● F025G4AA012	538,00 €
● F025G4AA018	538,00 €
● F025G4AA030	538,00 €
● F025G4AA033	538,00 €

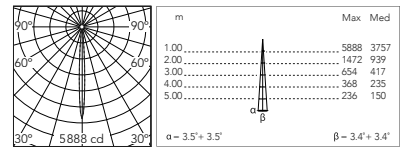

@ 3000K

Optic Spot 14°

Power Led: 7,9W - 671 lm ≠ FIXT 550 lm - 2700K/CRI 80 - 220-240V / 7,9W - 696 lm ≠ FIXT 571 lm - 3000K/CRI 80 - 220-240V / 7,9W - 720 lm ≠ FIXT 591 lm - 4000K/CRI 80 - 220-240V

2700K

Non Dimmable

○ F025G2BA001	538,00 €
● F025G2BA006	538,00 €
● F025G2BA012	538,00 €
● F025G2BA018	538,00 €
● F025G2BA030	538,00 €
● F025G2BA033	538,00 €

3000K

Non Dimmable

○ F025G3BA001	538,00 €
● F025G3BA006	538,00 €
● F025G3BA012	538,00 €
● F025G3BA018	538,00 €
● F025G3BA030	538,00 €
● F025G3BA033	538,00 €

4000K

Non Dimmable

○ F025G4BA001	538,00 €
● F025G4BA006	538,00 €
● F025G4BA012	538,00 €
● F025G4BA018	538,00 €
● F025G4BA030	538,00 €
● F025G4BA033	538,00 €

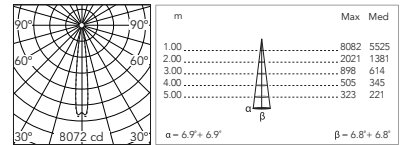

@ 3000K

Optic Medium Flood 24,5°

Power Led: 7,9W - 671 lm ≠ FIXT 499 lm - 2700K/CRI 80 - 220-240V / 7,9W - 696 lm ≠ FIXT 518 lm - 3000K/CRI 80 - 220-240V / 7,9W - 720 lm ≠ FIXT 536 lm - 4000K/CRI 80 - 220-240V

2700K

Non Dimmable

○ F025G2CA001	538,00 €
● F025G2CA006	538,00 €
● F025G2CA012	538,00 €
● F025G2CA018	538,00 €
● F025G2CA030	538,00 €
● F025G2CA033	538,00 €

3000K

Non Dimmable

○ F025G3CA001	538,00 €
● F025G3CA006	538,00 €
● F025G3CA012	538,00 €
● F025G3CA018	538,00 €
● F025G3CA030	538,00 €
● F025G3CA033	538,00 €

4000K

Non Dimmable

○ F025G4CA001	538,00 €
● F025G4CA006	538,00 €
● F025G4CA012	538,00 €
● F025G4CA018	538,00 €
● F025G4CA030	538,00 €
● F025G4CA033	538,00 €

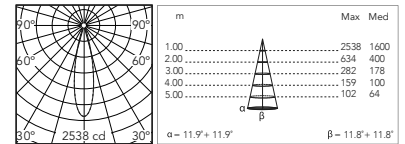

@ 3000K

Optic Flood 32°

Power Led: 7,9W - 671 lm ≠ FIXT 482 lm - 2700K/CRI 80 - 220-240V / 7,9W - 696 lm ≠ FIXT 500 lm - 3000K/CRI 80 - 220-240V / 7,9W - 720 lm ≠ FIXT 518 lm - 4000K/CRI 80 - 220-240V

2700K

Non Dimmable

○ F025G2DA001	538,00 €
● F025G2DA006	538,00 €
● F025G2DA012	538,00 €
● F025G2DA018	538,00 €
● F025G2DA030	538,00 €
● F025G2DA033	538,00 €

3000K

Non Dimmable

○ F025G3DA001	538,00 €
● F025G3DA006	538,00 €
● F025G3DA012	538,00 €
● F025G3DA018	538,00 €
● F025G3DA030	538,00 €
● F025G3DA033	538,00 €

4000K

Non Dimmable

○ F025G4DA001	538,00 €
● F025G4DA006	538,00 €
● F025G4DA012	538,00 €
● F025G4DA018	538,00 €
● F025G4DA030	538,00 €
● F025G4DA033	538,00 €

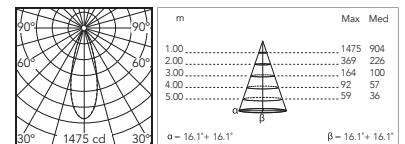

@ 3000K

Spine F 1 Ultra

Optic Wide Flood 49°

Power Led: 7,9W - 671 lm ≠ FIXT 480 lm - 2700K/CRI 80 - 220-240V / 7,9W - 696 lm ≠ FIXT 490 lm - 3000K/CRI 80 - 220-240V / 7,9W - 720 lm ≠ FIXT 505 lm - 4000K/CRI 80 - 220-240V

2700K

Non Dimmable

○ F025G2EA001	538,00 €
● F025G2EA006	538,00 €
● F025G2EA012	538,00 €
● F025G2EA018	538,00 €
● F025G2EA030	538,00 €
● F025G2EA033	538,00 €

3000K

Non Dimmable

○ F025G3EA001	538,00 €
● F025G3EA006	538,00 €
● F025G3EA012	538,00 €
● F025G3EA018	538,00 €
● F025G3EA030	538,00 €
● F025G3EA033	538,00 €

4000K

Non Dimmable

○ F025G4EA001	538,00 €
● F025G4EA006	538,00 €
● F025G4EA012	538,00 €
● F025G4EA018	538,00 €
● F025G4EA030	538,00 €
● F025G4EA033	538,00 €

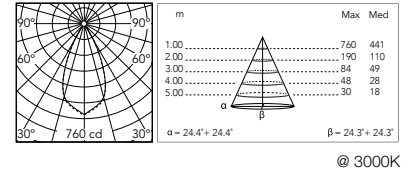

@ 3000K

Optic Elliptical 1 13,5° x 50°

Power Led: 7,9W - 671 lm ≠ FIXT 500 lm - 2700K/CRI 80 - 220-240V / 7,9W - 696 lm ≠ FIXT 519 lm - 3000K/CRI 80 - 220-240V / 7,9W - 720 lm ≠ FIXT 537 lm - 4000K/CRI 80 - 220-240V

2700K

Non Dimmable

○ F025G2FA001	538,00 €
● F025G2FA006	538,00 €
● F025G2FA012	538,00 €
● F025G2FA018	538,00 €
● F025G2FA030	538,00 €
● F025G2FA033	538,00 €

3000K

Non Dimmable

○ F025G3FA001	538,00 €
● F025G3FA006	538,00 €
● F025G3FA012	538,00 €
● F025G3FA018	538,00 €
● F025G3FA030	538,00 €
● F025G3FA033	538,00 €

4000K

Non Dimmable

○ F025G4FA001	538,00 €
● F025G4FA006	538,00 €
● F025G4FA012	538,00 €
● F025G4FA018	538,00 €
● F025G4FA030	538,00 €
● F025G4FA033	538,00 €

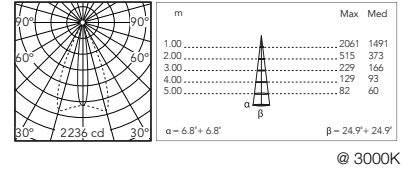

@ 3000K

Optic Elliptical 2 26° x 51°

Power Led: 7,9W - 671 lm ≠ FIXT 487 lm - 2700K/CRI 80 - 220-240V / 7,9W - 696 lm ≠ FIXT 505 lm - 3000K/CRI 80 - 220-240V / 7,9W - 720 lm ≠ FIXT 523 lm - 4000K/CRI 80 - 220-240V

2700K

Non Dimmable

○ F025G2GA001	538,00 €
● F025G2GA006	538,00 €
● F025G2GA012	538,00 €
● F025G2GA018	538,00 €
● F025G2GA030	538,00 €
● F025G2GA033	538,00 €

3000K

Non Dimmable

○ F025G3GA001	538,00 €
● F025G3GA006	538,00 €
● F025G3GA012	538,00 €
● F025G3GA018	538,00 €
● F025G3GA030	538,00 €
● F025G3GA033	538,00 €

4000K

Non Dimmable

○ F025G4GA001	538,00 €
● F025G4GA006	538,00 €
● F025G4GA012	538,00 €
● F025G4GA018	538,00 €
● F025G4GA030	538,00 €
● F025G4GA033	538,00 €

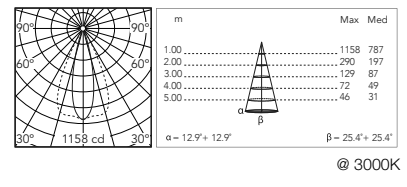

@ 3000K

Optic Wall Washer

Power Led: 7,9W - 671 lm ≠ FIXT 471 lm - 2700K/CRI 80 - 220-240V / 7,9W - 696 lm ≠ FIXT 489 lm - 3000K/CRI 80 - 220-240V / 7,9W - 720 lm ≠ FIXT 506 lm - 4000K/CRI 80 - 220-240V

2700K

Non Dimmable

○ F025G2HA001	538,00 €
● F025G2HA006	538,00 €
● F025G2HA012	538,00 €
● F025G2HA018	538,00 €
● F025G2HA030	538,00 €
● F025G2HA033	538,00 €

3000K

Non Dimmable

○ F025G3HA001	538,00 €
● F025G3HA006	538,00 €
● F025G3HA012	538,00 €
● F025G3HA018	538,00 €
● F025G3HA030	538,00 €
● F025G3HA033	538,00 €

4000K

Non Dimmable

○ F025G4HA001	538,00 €
● F025G4HA006	538,00 €
● F025G4HA012	538,00 €
● F025G4HA018	538,00 €
● F025G4HA030	538,00 €
● F025G4HA033	538,00 €

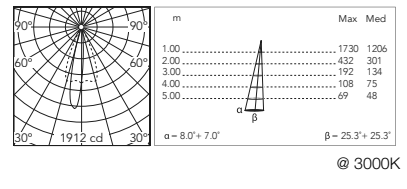

@ 3000K

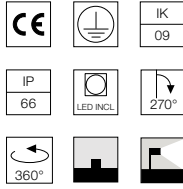
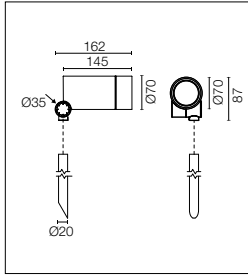

Source LED à basse consommation incluse. Équipée d'un snoot intégré pour un plus grand confort visuel: viseur asymétrique disponible en tant qu'accessoire. Les collimateurs sont des accessoires disponibles pour modifier la largeur du faisceau lumineux. Source d'alimentation électrique intégrée 220-240V ON/OFF. Équipée d'un câble en néoprène de 5m (10m sur commande) pour une connexion à distance; pour garantir l'étanchéité, il est conseillé d'utiliser des câbles flexibles conçus pour l'extérieur. La tige pour les installations au sol est disponible en deux tailles et doit se commander séparément. Sur commande, version réglable 1-10V ou DALI avec source d'alimentation à distance 24Vdc.

Energy-efficient Power LED source included Equipped with an integrated snoot for higher visual comfort: the asymmetrical cut visor is available as an accessory. Collimators are available as an accessory to modify the beam opening. Integrated electric power supply 220-240V ON/OFF. Equipped with a 5m neoprene cable (10m upon request) for remote connection. To guarantee its water tightness, it is recommended to use flexible cables designed for outdoor use. The rod for ground installations is available in two sizes and needs to be ordered separately. Upon request: 1-10V or DALI dimmable version with 24Vdc remote power supply.

Optic Spot 12°

Power Led: 10,5W - 920 lm ≠ FIXT 680 lm - 2700K/CRI 80 - 220-240V / 10,5W - 966 lm ≠ FIXT 706 lm - 3000K/CRI 80 - 220-240V / 10,5W - 1012 lm ≠ FIXT 730 lm - 4000K/CRI 80 - 220-240V

2700K

Non Dimmable

○ F025H2BA001	538,00 €
● F025H2BA006	538,00 €
● F025H2BA012	538,00 €
● F025H2BA018	538,00 €
● F025H2BA030	538,00 €
● F025H2BA033	538,00 €

3000K

Non Dimmable

○ F025H3BA001	538,00 €
● F025H3BA006	538,00 €
● F025H3BA012	538,00 €
● F025H3BA018	538,00 €
● F025H3BA030	538,00 €
● F025H3BA033	538,00 €

4000K

Non Dimmable

○ F025H4BA001	538,00 €
● F025H4BA006	538,00 €
● F025H4BA012	538,00 €
● F025H4BA018	538,00 €
● F025H4BA030	538,00 €
● F025H4BA033	538,00 €

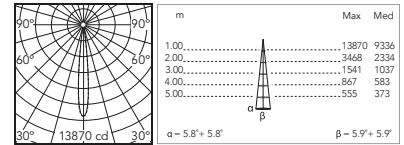

@ 3000K

Optic Medium Flood 26,5°

Power Led: 10,5W - 920 lm ≠ FIXT 594 lm - 2700K/CRI 80 - 220-240V / 10,5W - 966 lm ≠ FIXT 630 lm - 3000K/CRI 80 - 220-240V / 10,5W - 1012 lm ≠ FIXT 654 lm - 4000K/CRI 80 - 220-240V

2700K

Non Dimmable

○ F025H2CA001	538,00 €
● F025H2CA006	538,00 €
● F025H2CA012	538,00 €
● F025H2CA018	538,00 €
● F025H2CA030	538,00 €
● F025H2CA033	538,00 €

3000K

Non Dimmable

○ F025H3CA001	538,00 €
● F025H3CA006	538,00 €
● F025H3CA012	538,00 €
● F025H3CA018	538,00 €
● F025H3CA030	538,00 €
● F025H3CA033	538,00 €

4000K

Non Dimmable

○ F025H4CA001	538,00 €
● F025H4CA006	538,00 €
● F025H4CA012	538,00 €
● F025H4CA018	538,00 €
● F025H4CA030	538,00 €
● F025H4CA033	538,00 €

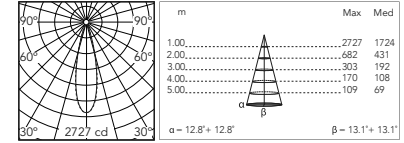

@ 3000K

Optic Flood 33,5°

Power Led: 10,5W - 920 lm ≠ FIXT 592 lm - 2700K/CRI 80 - 220-240V / 10,5W - 966 lm ≠ FIXT 627 lm - 3000K/CRI 80 - 220-240V / 10,5W - 1012 lm ≠ FIXT 651 lm - 4000K/CRI 80 - 220-240V

2700K

Non Dimmable

○ F025H2DA001	538,00 €
● F025H2DA006	538,00 €
● F025H2DA012	538,00 €
● F025H2DA018	538,00 €
● F025H2DA030	538,00 €
● F025H2DA033	538,00 €

3000K

Non Dimmable

○ F025H3DA001	538,00 €
● F025H3DA006	538,00 €
● F025H3DA012	538,00 €
● F025H3DA018	538,00 €
● F025H3DA030	538,00 €
● F025H3DA033	538,00 €

4000K

Non Dimmable

○ F025H4DA001	538,00 €
● F025H4DA006	538,00 €
● F025H4DA012	538,00 €
● F025H4DA018	538,00 €
● F025H4DA030	538,00 €
● F025H4DA033	538,00 €

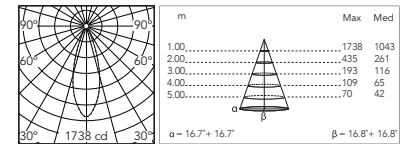

@ 3000K

Optic Wide Flood 50°

Power Led: 10,5W - 920 lm ≠ FIXT 591 lm - 2700K/CRI 80 - 220-240V / 10,5W - 966 lm ≠ FIXT 619 lm - 3000K/CRI 80 - 220-240V / 10,5W - 1012 lm ≠ FIXT 650 lm - 4000K/CRI 80 - 220-240V

2700K

Non Dimmable

○ F025H2EA001	538,00 €
● F025H2EA006	538,00 €
● F025H2EA012	538,00 €
● F025H2EA018	538,00 €
● F025H2EA030	538,00 €
● F025H2EA033	538,00 €

3000K

Non Dimmable

○ F025H3EA001	538,00 €
● F025H3EA006	538,00 €
● F025H3EA012	538,00 €
● F025H3EA018	538,00 €
● F025H3EA030	538,00 €
● F025H3EA033	538,00 €

4000K

Non Dimmable

○ F025H4EA001	538,00 €
● F025H4EA006	538,00 €
● F025H4EA012	538,00 €
● F025H4EA018	538,00 €
● F025H4EA030	538,00 €
● F025H4EA033	538,00 €

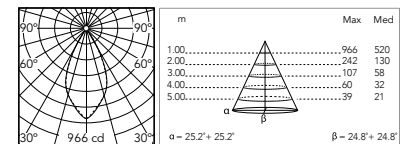

@ 3000K

Spine F 1 Ultra Hp

Optic Elliptical 1 11,5° x 49°

Power Led: 10,5W - 920 lm ≠ FIXT 603 lm - 2700K/CRI 80 - 220-240V / 10,5W - 966 lm ≠ FIXT 639 lm - 3000K/CRI 80 - 220-240V / 10,5W - 1012 lm ≠ FIXT 663 lm - 4000K/CRI 80 - 220-240V

2700K

Non Dimmable

○ F025H2FA001	538,00 €
● F025H2FA006	538,00 €
● F025H2FA012	538,00 €
● F025H2FA018	538,00 €
● F025H2FA030	538,00 €
● F025H2FA033	538,00 €

3000K

Non Dimmable

○ F025H3FA001	538,00 €
● F025H3FA006	538,00 €
● F025H3FA012	538,00 €
● F025H3FA018	538,00 €
● F025H3FA030	538,00 €
● F025H3FA033	538,00 €

4000K

Non Dimmable

○ F025H4FA001	538,00 €
● F025H4FA006	538,00 €
● F025H4FA012	538,00 €
● F025H4FA018	538,00 €
● F025H4FA030	538,00 €
● F025H4FA033	538,00 €

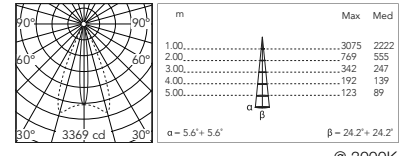

Optic Elliptical 2 25,5° x 50°

Power Led: 10,5W - 920 lm ≠ FIXT 601 lm - 2700K/CRI 80 - 220-240V / 10,5W - 966 lm ≠ FIXT 624 lm - 3000K/CRI 80 - 220-240V / 10,5W - 1012 lm ≠ FIXT 645 lm - 4000K/CRI 80 - 220-240V

2700K

Non Dimmable

○ F025H2GA001	538,00 €
● F025H2GA006	538,00 €
● F025H2GA012	538,00 €
● F025H2GA018	538,00 €
● F025H2GA030	538,00 €
● F025H2GA033	538,00 €

3000K

Non Dimmable

○ F025H3GA001	538,00 €
● F025H3GA006	538,00 €
● F025H3GA012	538,00 €
● F025H3GA018	538,00 €
● F025H3GA030	538,00 €
● F025H3GA033	538,00 €

4000K

Non Dimmable

○ F025H4GA001	538,00 €
● F025H4GA006	538,00 €
● F025H4GA012	538,00 €
● F025H4GA018	538,00 €
● F025H4GA030	538,00 €
● F025H4GA033	538,00 €

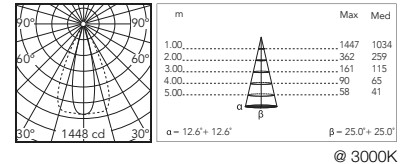

Optic Wall Washer

Power Led: 10,5W - 920 lm ≠ FIXT 574 lm - 2700K/CRI 80 - 220-240V / 10,5W - 966 lm ≠ FIXT 609 lm - 3000K/CRI 80 - 220-240V / 10,5W - 1012 lm ≠ FIXT 631 lm - 4000K/CRI 80 - 220-240V

2700K

Non Dimmable

○ F025H2HA001	538,00 €
● F025H2HA006	538,00 €
● F025H2HA012	538,00 €
● F025H2HA018	538,00 €
● F025H2HA030	538,00 €
● F025H2HA033	538,00 €

3000K

Non Dimmable

○ F025H3HA001	538,00 €
● F025H3HA006	538,00 €
● F025H3HA012	538,00 €
● F025H3HA018	538,00 €
● F025H3HA030	538,00 €
● F025H3HA033	538,00 €







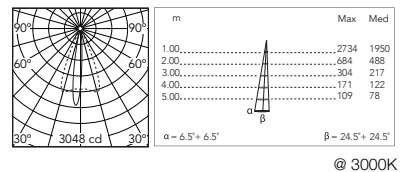



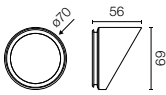

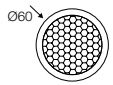
4000K

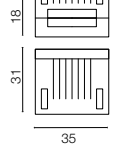
Non Dimmable

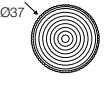
○ F025H4HA001	538,00 €
● F025H4HA006	538,00 €
● F025H4HA012	538,00 €
● F025H4HA018	538,00 €
● F025H4HA030	538,00 €
● F025H4HA033	538,00 €

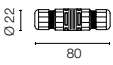

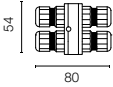
Spine F 1 Ultra: Accessoires / Accessories

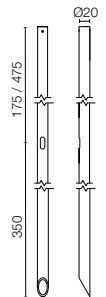
Viseur	Visor	○ F025Z050001	50,00 €		
		● F025Z050006	50,00 €		
		● F025Z050012	50,00 €		
		● F025Z050018	50,00 €		
		● F025Z050030	50,00 €		
		● F025Z050033	50,00 €		
Honeycomb	Honeycomb Louvre	F025Z060000	20,00 €		
Gelbox IPX8 pour le raccordement électrique.	Gelbox IPX8 for splicing connectors.	F990C100000	14,00 €		
Lentilles de conversion / Converter lenses:					
- Converter Spine 0 / Spine 1 Optic Medium Flood	F029Z010000	35,00 €			
- Converter Spine 0 / Spine 1 Optic Flood	F029Z011000	35,00 €			
- Converter Spine 0 / Spine 1 Optic Wide Flood	F029Z012000	35,00 €			
- Converter Spine 0 / Spine 1 Optic Elliptic 1	F029Z013000	35,00 €			
- Converter Spine 0 / Spine 1 Optic Elliptic 2	F029Z014000	35,00 €			
- Converter Spine 0 / Spine 1 Optic Wall Washer	F029Z015000	35,00 €			
Système de jonction IP68 H2O Stop anti-condensation à 2 voies 4 pôles.	2 way terminal block 4 poles IP68 H2O Stop.	F990C00A000	33,00 €		
Système de jonction IP68 H2O Stop anti-condensation à 3/4 voies 4 pôles. (Ø5,5÷12mm câble).	3/4 way terminal block 4 poles IP68 H2O Stop. (Ø5,5÷12mm cable).	F990C010000	60,00 €		
Poteau longueur 200 - 500 mm au-dessus du sol pour des installations au sol.	Pole with an overground length of 200 - 500 mm for ground installation.	200 mm			
		○ F026Z020001	51,00 €		
		● F026Z020006	51,00 €		
		● F026Z020012	51,00 €		
		● F026Z020018	51,00 €		
		● F026Z020030	51,00 €		
		● F026Z020033	51,00 €		
		500 mm			
		○ F026Z030001	55,00 €		
		● F026Z030006	55,00 €		
		● F026Z030012	55,00 €		
		● F026Z030018	55,00 €		
		● F026Z030030	55,00 €		
		● F026Z030033	55,00 €		



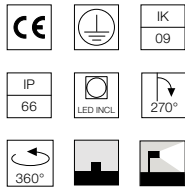
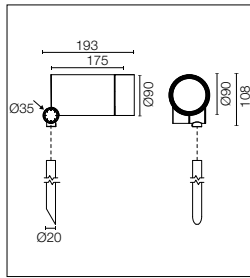

Source Power LED incluse. Équipée d'un snoot intégré pour un plus grand confort visuel: viseur asymétrique disponible en tant qu'accessoire. Les collimateurs sont des accessoires disponibles pour modifier la largeur du faisceau lumineux. Source d'alimentation électrique intégrée 220-240V ON/OFF et réglable 1-10V ou DALI. Équipée d'un câble en néoprène de 5m (10m sur commande) pour une connexion à distance; pour garantir l'étanchéité, il est conseillé d'utiliser des câbles flexibles conçus pour l'extérieur. La tige pour les installations au sol est disponible en deux tailles et doit se commander séparément.

Power LED source included. Equipped with an integrated snoot for higher visual comfort: the asymmetrical cut visor is available as an accessory. Collimators are available as an accessory to modify the beam opening. Integrated electric power supply 220-240V ON/OFF and adjustable 1-10V or DALI. Equipped with a 5m neoprene cable (10m upon request) for remote connection. To guarantee its water tightness, it is recommended to use flexible cables designed for outdoor use. The rod for ground installations is available in two sizes and needs to be ordered separately.

Optic Narrow Spot
2200K disponible sur demande.

Optic Narrow Spot
2200K available on request.

Optic Narrow Spot 6°

Power Led: 4,1W - 248 lm ≠ FIXT 230 lm - 2700K/CRI 80 - 220-240V / 4,1W - 258 lm ≠ FIXT 239 lm - 3000K/CRI 80 - 220-240V / 4,1W - 267 lm ≠ FIXT 247 lm - 4000K/CRI 80 - 220-240V

2700K

Non Dimmable

- F026G2AA001 658,00 €
- F026G2AA006 658,00 €
- F026G2AA012 658,00 €
- F026G2AA018 658,00 €
- F026G2AA030 658,00 €
- F026G2AA033 658,00 €
- 1-10V
- F026G2AB001 710,00 €
- F026G2AB006 710,00 €
- F026G2AB012 710,00 €
- F026G2AB018 710,00 €
- F026G2AB030 710,00 €
- F026G2AB033 710,00 €
- Dali
- F026G2AD001 710,00 €
- F026G2AD006 710,00 €
- F026G2AD012 710,00 €
- F026G2AD018 710,00 €
- F026G2AD030 710,00 €
- F026G2AD033 710,00 €

3000K

Non Dimmable

- F026G3AA001 658,00 €
- F026G3AA006 658,00 €
- F026G3AA012 658,00 €
- F026G3AA018 658,00 €
- F026G3AA030 658,00 €
- F026G3AA033 658,00 €
- 1-10V
- F026G3AB001 710,00 €
- F026G3AB006 710,00 €
- F026G3AB012 710,00 €
- F026G3AB018 710,00 €
- F026G3AB030 710,00 €
- F026G3AB033 710,00 €
- Dali
- F026G3AD001 710,00 €
- F026G3AD006 710,00 €
- F026G3AD012 710,00 €
- F026G3AD018 710,00 €
- F026G3AD030 710,00 €
- F026G3AD033 710,00 €

4000K

Non Dimmable

- F026G4AA001 658,00 €
- F026G4AA006 658,00 €
- F026G4AA012 658,00 €
- F026G4AA018 658,00 €
- F026G4AA030 658,00 €
- F026G4AA033 658,00 €
- 1-10V
- F026G4AB001 710,00 €
- F026G4AB006 710,00 €
- F026G4AB012 710,00 €
- F026G4AB018 710,00 €
- F026G4AB030 710,00 €
- F026G4AB033 710,00 €
- Dali
- F026G4AD001 710,00 €
- F026G4AD006 710,00 €
- F026G4AD012 710,00 €
- F026G4AD018 710,00 €
- F026G4AD030 710,00 €
- F026G4AD033 710,00 €

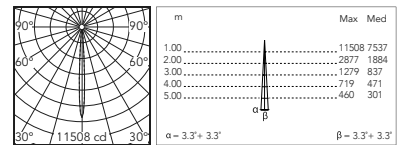

@ 3000K

Optic Spot 9,5°

Power Led: 10,5W - 920 lm ≠ FIXT 769 lm - 2700K/CRI 80 - 220-240V / 10,5W - 966 lm ≠ FIXT 808 lm - 3000K/CRI 80 - 220-240V / 10,5W - 1012 lm ≠ FIXT 846 lm - 4000K/CRI 80 - 220-240V

2700K

Non Dimmable

- F026G2BA001 658,00 €
- F026G2BA006 658,00 €
- F026G2BA012 658,00 €
- F026G2BA018 658,00 €
- F026G2BA030 658,00 €
- F026G2BA033 658,00 €
- 1-10V
- F026G2BB001 710,00 €
- F026G2BB006 710,00 €
- F026G2BB012 710,00 €
- F026G2BB018 710,00 €
- F026G2BB030 710,00 €
- F026G2BB033 710,00 €
- Dali
- F026G2BD001 710,00 €
- F026G2BD006 710,00 €
- F026G2BD012 710,00 €
- F026G2BD018 710,00 €
- F026G2BD030 710,00 €
- F026G2BD033 710,00 €

3000K

Non Dimmable

- F026G3BA001 658,00 €
- F026G3BA006 658,00 €
- F026G3BA012 658,00 €
- F026G3BA018 658,00 €
- F026G3BA030 658,00 €
- F026G3BA033 658,00 €
- 1-10V
- F026G3BB001 710,00 €
- F026G3BB006 710,00 €
- F026G3BB012 710,00 €
- F026G3BB018 710,00 €
- F026G3BB030 710,00 €
- F026G3BB033 710,00 €
- Dali
- F026G3BD001 710,00 €
- F026G3BD006 710,00 €
- F026G3BD012 710,00 €
- F026G3BD018 710,00 €
- F026G3BD030 710,00 €
- F026G3BD033 710,00 €

4000K

Non Dimmable

- F026G4BA001 658,00 €
- F026G4BA006 658,00 €
- F026G4BA012 658,00 €
- F026G4BA018 658,00 €
- F026G4BA030 658,00 €
- F026G4BA033 658,00 €
- 1-10V
- F026G4BB001 710,00 €
- F026G4BB006 710,00 €
- F026G4BB012 710,00 €
- F026G4BB018 710,00 €
- F026G4BB030 710,00 €
- F026G4BB033 710,00 €
- Dali
- F026G4BD001 710,00 €
- F026G4BD006 710,00 €
- F026G4BD012 710,00 €
- F026G4BD018 710,00 €
- F026G4BD030 710,00 €
- F026G4BD033 710,00 €

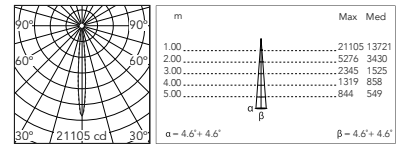

@ 3000K

Spine F 2 Ultra

Optic Medium Flood 28°

Power Led: 10,5W - 920 lm ≠ FIXT 715 lm - 2700K/CRI 80 - 220-240V / 10,5W - 966 lm ≠ FIXT 742 lm - 3000K/CRI 80 - 220-240V / 10,5W - 1012 lm ≠ FIXT 767 lm - 4000K/CRI 80 - 220-240V

2700K		3000K		4000K	
Non Dimmable		Non Dimmable		Non Dimmable	
○ F026G2CA001	658,00 €	○ F026G3CA001	658,00 €	○ F026G4CA001	658,00 €
● F026G2CA006	658,00 €	● F026G3CA006	658,00 €	● F026G4CA006	658,00 €
● F026G2CA012	658,00 €	● F026G3CA012	658,00 €	● F026G4CA012	658,00 €
● F026G2CA018	658,00 €	● F026G3CA018	658,00 €	● F026G4CA018	658,00 €
● F026G2CA030	658,00 €	● F026G3CA030	658,00 €	● F026G4CA030	658,00 €
● F026G2CA033	658,00 €	● F026G3CA033	658,00 €	● F026G4CA033	658,00 €
1-10V		1-10V		1-10V	
○ F026G2CB001	710,00 €	○ F026G3CB001	710,00 €	○ F026G4CB001	710,00 €
● F026G2CB006	710,00 €	● F026G3CB006	710,00 €	● F026G4CB006	710,00 €
● F026G2CB012	710,00 €	● F026G3CB012	710,00 €	● F026G4CB012	710,00 €
● F026G2CB018	710,00 €	● F026G3CB018	710,00 €	● F026G4CB018	710,00 €
● F026G2CB030	710,00 €	● F026G3CB030	710,00 €	● F026G4CB030	710,00 €
● F026G2CB033	710,00 €	● F026G3CB033	710,00 €	● F026G4CB033	710,00 €
Dali		Dali		Dali	
○ F026G2CD001	710,00 €	○ F026G3CD001	710,00 €	○ F026G4CD001	710,00 €
● F026G2CD006	710,00 €	● F026G3CD006	710,00 €	● F026G4CD006	710,00 €
● F026G2CD012	710,00 €	● F026G3CD012	710,00 €	● F026G4CD012	710,00 €
● F026G2CD018	710,00 €	● F026G3CD018	710,00 €	● F026G4CD018	710,00 €
● F026G2CD030	710,00 €	● F026G3CD030	710,00 €	● F026G4CD030	710,00 €
● F026G2CD033	710,00 €	● F026G3CD033	710,00 €	● F026G4CD033	710,00 €

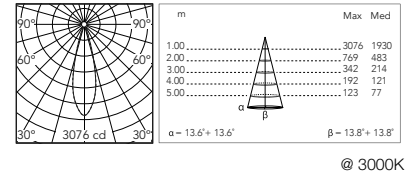

Optic Flood 33°

Power Led: 10,5W - 920 lm ≠ FIXT 695 lm - 2700K/CRI 80 - 220-240V / 10,5W - 966 lm ≠ FIXT 721 lm - 3000K/CRI 80 - 220-240V / 10,5W - 1012 lm ≠ FIXT 746 lm - 4000K/CRI 80 - 220-240V

2700K		3000K		4000K	
Non Dimmable		Non Dimmable		Non Dimmable	
○ F026G2DA001	658,00 €	○ F026G3DA001	658,00 €	○ F026G4DA001	658,00 €
● F026G2DA006	658,00 €	● F026G3DA006	658,00 €	● F026G4DA006	658,00 €
● F026G2DA012	658,00 €	● F026G3DA012	658,00 €	● F026G4DA012	658,00 €
● F026G2DA018	658,00 €	● F026G3DA018	658,00 €	● F026G4DA018	658,00 €
● F026G2DA030	658,00 €	● F026G3DA030	658,00 €	● F026G4DA030	658,00 €
● F026G2DA033	658,00 €	● F026G3DA033	658,00 €	● F026G4DA033	658,00 €
1-10V		1-10V		1-10V	
○ F026G2DB001	710,00 €	○ F026G3DB001	710,00 €	○ F026G4DB001	710,00 €
● F026G2DB006	710,00 €	● F026G3DB006	710,00 €	● F026G4DB006	710,00 €
● F026G2DB012	710,00 €	● F026G3DB012	710,00 €	● F026G4DB012	710,00 €
● F026G2DB018	710,00 €	● F026G3DB018	710,00 €	● F026G4DB018	710,00 €
● F026G2DB030	710,00 €	● F026G3DB030	710,00 €	● F026G4DB030	710,00 €
● F026G2DB033	710,00 €	● F026G3DB033	710,00 €	● F026G4DB033	710,00 €
Dali		Dali		Dali	
○ F026G2DD001	710,00 €	○ F026G3DD001	710,00 €	○ F026G4DD001	710,00 €
● F026G2DD006	710,00 €	● F026G3DD006	710,00 €	● F026G4DD006	710,00 €
● F026G2DD012	710,00 €	● F026G3DD012	710,00 €	● F026G4DD012	710,00 €
● F026G2DD018	710,00 €	● F026G3DD018	710,00 €	● F026G4DD018	710,00 €
● F026G2DD030	710,00 €	● F026G3DD030	710,00 €	● F026G4DD030	710,00 €
● F026G2DD033	710,00 €	● F026G3DD033	710,00 €	● F026G4DD033	710,00 €

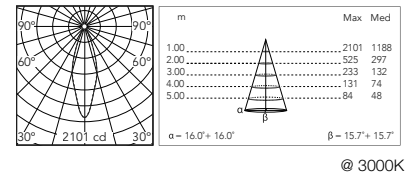

Optic Wide Flood 51°

Power Led: 10,5W - 920 lm ≠ FIXT 711 lm - 2700K/CRI 80 - 220-240V / 10,5W - 966 lm ≠ FIXT 741 lm - 3000K/CRI 80 - 220-240V / 10,5W - 1012 lm ≠ FIXT 778 lm - 4000K/CRI 80 - 220-240V

2700K		3000K		4000K	
Non Dimmable		Non Dimmable		Non Dimmable	
○ F026G2EA001	658,00 €	○ F026G3EA001	658,00 €	○ F026G4EA001	658,00 €
● F026G2EA006	658,00 €	● F026G3EA006	658,00 €	● F026G4EA006	658,00 €
● F026G2EA012	658,00 €	● F026G3EA012	658,00 €	● F026G4EA012	658,00 €
● F026G2EA018	658,00 €	● F026G3EA018	658,00 €	● F026G4EA018	658,00 €
● F026G2EA030	658,00 €	● F026G3EA030	658,00 €	● F026G4EA030	658,00 €
● F026G2EA033	658,00 €	● F026G3EA033	658,00 €	● F026G4EA033	658,00 €
1-10V		1-10V		1-10V	
○ F026G2EB001	710,00 €	○ F026G3EB001	710,00 €	○ F026G4EB001	710,00 €
● F026G2EB006	710,00 €	● F026G3EB006	710,00 €	● F026G4EB006	710,00 €
● F026G2EB012	710,00 €	● F026G3EB012	710,00 €	● F026G4EB012	710,00 €
● F026G2EB018	710,00 €	● F026G3EB018	710,00 €	● F026G4EB018	710,00 €
● F026G2EB030	710,00 €	● F026G3EB030	710,00 €	● F026G4EB030	710,00 €
● F026G2EB033	710,00 €	● F026G3EB033	710,00 €	● F026G4EB033	710,00 €
Dali		Dali		Dali	
○ F026G2ED001	710,00 €	○ F026G3ED001	710,00 €	○ F026G4ED001	710,00 €
● F026G2ED006	710,00 €	● F026G3ED006	710,00 €	● F026G4ED006	710,00 €
● F026G2ED012	710,00 €	● F026G3ED012	710,00 €	● F026G4ED012	710,00 €
● F026G2ED018	710,00 €	● F026G3ED018	710,00 €	● F026G4ED018	710,00 €
● F026G2ED030	710,00 €	● F026G3ED030	710,00 €	● F026G4ED030	710,00 €
● F026G2ED033	710,00 €	● F026G3ED033	710,00 €	● F026G4ED033	710,00 €

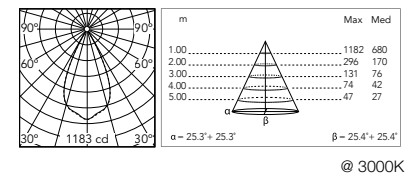

Spine F 2 Ultra

Optic Elliptical 1 9,5° x 48°

Power Led: 10,5W - 920 lm ≠ FIXT 717 lm - 2700K/CRI 80 - 220-240V / 10,5W - 966 lm ≠ FIXT 744 lm - 3000K/CRI 80 - 220-240V / 10,5W - 1012 lm ≠ FIXT 770 lm - 4000K/CRI 80 - 220-240V

2700K		3000K		4000K	
Non Dimmable		Non Dimmable		Non Dimmable	
○ F026G2FA001	658,00 €	○ F026G3FA001	658,00 €	○ F026G4FA001	658,00 €
● F026G2FA006	658,00 €	● F026G3FA006	658,00 €	● F026G4FA006	658,00 €
● F026G2FA012	658,00 €	● F026G3FA012	658,00 €	● F026G4FA012	658,00 €
● F026G2FA018	658,00 €	● F026G3FA018	658,00 €	● F026G4FA018	658,00 €
● F026G2FA030	658,00 €	● F026G3FA030	658,00 €	● F026G4FA030	658,00 €
● F026G2FA033	658,00 €	● F026G3FA033	658,00 €	● F026G4FA033	658,00 €
1-10V					
○ F026G2FB001	710,00 €	○ F026G3FB001	710,00 €	○ F026G4FB001	710,00 €
● F026G2FB006	710,00 €	● F026G3FB006	710,00 €	● F026G4FB006	710,00 €
● F026G2FB012	710,00 €	● F026G3FB012	710,00 €	● F026G4FB012	710,00 €
● F026G2FB018	710,00 €	● F026G3FB018	710,00 €	● F026G4FB018	710,00 €
● F026G2FB030	710,00 €	● F026G3FB030	710,00 €	● F026G4FB030	710,00 €
● F026G2FB033	710,00 €	● F026G3FB033	710,00 €	● F026G4FB033	710,00 €
Dali					
○ F026G2FD001	710,00 €	○ F026G3FD001	710,00 €	○ F026G4FD001	710,00 €
● F026G2FD006	710,00 €	● F026G3FD006	710,00 €	● F026G4FD006	710,00 €
● F026G2FD012	710,00 €	● F026G3FD012	710,00 €	● F026G4FD012	710,00 €
● F026G2FD018	710,00 €	● F026G3FD018	710,00 €	● F026G4FD018	710,00 €
● F026G2FD030	710,00 €	● F026G3FD030	710,00 €	● F026G4FD030	710,00 €
● F026G2FD033	710,00 €	● F026G3FD033	710,00 €	● F026G4FD033	710,00 €

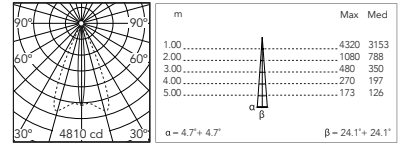

© 3000K

Optic Elliptical 2 24° x 50°

Power Led: 10,5W - 920 lm ≠ FIXT 699 lm - 2700K/CRI 80 - 220-240V / 10,5W - 966 lm ≠ FIXT 725 lm - 3000K/CRI 80 - 220-240V / 10,5W - 1012 lm ≠ FIXT 750 lm - 4000K/CRI 80 - 220-240V

2700K		3000K		4000K	
Non Dimmable		Non Dimmable		Non Dimmable	
○ F026G2GA001	658,00 €	○ F026G3GA001	658,00 €	○ F026G4GA001	658,00 €
● F026G2GA006	658,00 €	● F026G3GA006	658,00 €	● F026G4GA006	658,00 €
● F026G2GA012	658,00 €	● F026G3GA012	658,00 €	● F026G4GA012	658,00 €
● F026G2GA018	658,00 €	● F026G3GA018	658,00 €	● F026G4GA018	658,00 €
● F026G2GA030	658,00 €	● F026G3GA030	658,00 €	● F026G4GA030	658,00 €
● F026G2GA033	658,00 €	● F026G3GA033	658,00 €	● F026G4GA033	658,00 €
1-10V					
○ F026G2GB001	710,00 €	○ F026G3GB001	710,00 €	○ F026G4GB001	710,00 €
● F026G2GB006	710,00 €	● F026G3GB006	710,00 €	● F026G4GB006	710,00 €
● F026G2GB012	710,00 €	● F026G3GB012	710,00 €	● F026G4GB012	710,00 €
● F026G2GB018	710,00 €	● F026G3GB018	710,00 €	● F026G4GB018	710,00 €
● F026G2GB030	710,00 €	● F026G3GB030	710,00 €	● F026G4GB030	710,00 €
● F026G2GB033	710,00 €	● F026G3GB033	710,00 €	● F026G4GB033	710,00 €
Dali					
○ F026G2GD001	710,00 €	○ F026G3GD001	710,00 €	○ F026G4GD001	710,00 €
● F026G2GD006	710,00 €	● F026G3GD006	710,00 €	● F026G4GD006	710,00 €
● F026G2GD012	710,00 €	● F026G3GD012	710,00 €	● F026G4GD012	710,00 €
● F026G2GD018	710,00 €	● F026G3GD018	710,00 €	● F026G4GD018	710,00 €
● F026G2GD030	710,00 €	● F026G3GD030	710,00 €	● F026G4GD030	710,00 €
● F026G2GD033	710,00 €	● F026G3GD033	710,00 €	● F026G4GD033	710,00 €

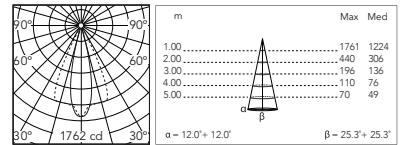

© 3000K

Optic Wall Washer

Power Led: 10,5W - 920 lm ≠ FIXT 673 lm - 2700K/CRI 80 - 220-240V / 10,5W - 966 lm ≠ FIXT 698 lm - 3000K/CRI 80 - 220-240V / 10,5W - 1012 lm ≠ FIXT 672 lm - 4000K/CRI 80 - 220-240V

2700K		3000K		4000K	
Non Dimmable		Non Dimmable		Non Dimmable	
○ F026G2HA001	658,00 €	○ F026G3HA001	658,00 €	○ F026G4HA001	658,00 €
● F026G2HA006	658,00 €	● F026G3HA006	658,00 €	● F026G4HA006	658,00 €
● F026G2HA012	658,00 €	● F026G3HA012	658,00 €	● F026G4HA012	658,00 €
● F026G2HA018	658,00 €	● F026G3HA018	658,00 €	● F026G4HA018	658,00 €
● F026G2HA030	658,00 €	● F026G3HA030	658,00 €	● F026G4HA030	658,00 €
● F026G2HA033	658,00 €	● F026G3HA033	658,00 €	● F026G4HA033	658,00 €
1-10V					
○ F026G2HB001	710,00 €	○ F026G3HB001	710,00 €	○ F026G4HB001	710,00 €
● F026G2HB006	710,00 €	● F026G3HB006	710,00 €	● F026G4HB006	710,00 €
● F026G2HB012	710,00 €	● F026G3HB012	710,00 €	● F026G4HB012	710,00 €
● F026G2HB018	710,00 €	● F026G3HB018	710,00 €	● F026G4HB018	710,00 €
● F026G2HB030	710,00 €	● F026G3HB030	710,00 €	● F026G4HB030	710,00 €
● F026G2HB033	710,00 €	● F026G3HB033	710,00 €	● F026G4HB033	710,00 €
Dali					
○ F026G2HD001	710,00 €	○ F026G3HD001	710,00 €	○ F026G4HD001	710,00 €
● F026G2HD006	710,00 €	● F026G3HD006	710,00 €	● F026G4HD006	710,00 €
● F026G2HD012	710,00 €	● F026G3HD012	710,00 €	● F026G4HD012	710,00 €
● F026G2HD018	710,00 €	● F026G3HD018	710,00 €	● F026G4HD018	710,00 €
● F026G2HD030	710,00 €	● F026G3HD030	710,00 €	● F026G4HD030	710,00 €
● F026G2HD033	710,00 €	● F026G3HD033	710,00 €	● F026G4HD033	710,00 €

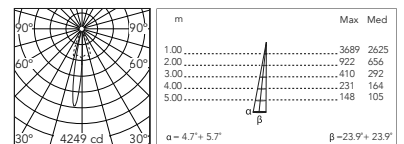

© 3000K

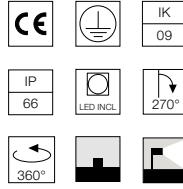
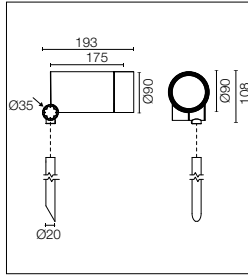

Source LED à basse consommation incluse. Équipée d'un snoot intégré pour un plus grand confort visuel: viseur asymétrique disponible en tant qu'accessoire. Les collimateurs sont des accessoires disponibles pour modifier la largeur du faisceau lumineux. Source d'alimentation électrique intégrée 220-240V ON/OFF et réglable 1-10V ou DALI. Équipée d'un câble en néoprène de 5m (10m sur commande) pour une connexion à distance; pour garantir l'étanchéité, il est conseillé d'utiliser des câbles flexibles conçus pour l'extérieur. La tige pour les installations au sol est disponible en deux tailles et doit se commander séparément.

Energy-efficient Power LED source included Equipped with an integrated snoot for higher visual comfort: the asymmetrical cut visor is available as an accessory. Collimators are available as an accessory to modify the beam opening. Integrated electric power supply 220-240V ON/OFF and adjustable 1-10V or DALI. Equipped with a 5m neoprene cable (10m upon request) for remote connection. To guarantee its water tightness, it is recommended to use flexible cables designed for outdoor use. The rod for ground installations is available in two sizes and needs to be ordered separately.

2200K disponible sur demande.

2200K available on request.

Optic Spot 14,5°

Power Led: 17W - 1739 lm ≠ FIXT 1443 lm - 2700K/CRI 80 - 220-240V / 17W - 1803 lm ≠ FIXT 1497 lm - 3000K/CRI 80 - 220-240V / 17W - 1868 lm ≠ FIXT 1548 lm - 4000K/CRI 80 - 220-240V

2700K		3000K		4000K	
Non Dimmable		Non Dimmable		Non Dimmable	
○ F026H2BA001	658,00 €	○ F026H3BA001	658,00 €	○ F026H4BA001	658,00 €
● F026H2BA006	658,00 €	● F026H3BA006	658,00 €	● F026H4BA006	658,00 €
● F026H2BA012	658,00 €	● F026H3BA012	658,00 €	● F026H4BA012	658,00 €
● F026H2BA018	658,00 €	● F026H3BA018	658,00 €	● F026H4BA018	658,00 €
● F026H2BA030	658,00 €	● F026H3BA030	658,00 €	● F026H4BA030	658,00 €
● F026H2BA033	658,00 €	● F026H3BA033	658,00 €	● F026H4BA033	658,00 €
1-10V		1-10V		1-10V	
○ F026H2BB001	710,00 €	○ F026H3BB001	710,00 €	○ F026H4BB001	710,00 €
● F026H2BB006	710,00 €	● F026H3BB006	710,00 €	● F026H4BB006	710,00 €
● F026H2BB012	710,00 €	● F026H3BB012	710,00 €	● F026H4BB012	710,00 €
● F026H2BB018	710,00 €	● F026H3BB018	710,00 €	● F026H4BB018	710,00 €
● F026H2BB030	710,00 €	● F026H3BB030	710,00 €	● F026H4BB030	710,00 €
● F026H2BB033	710,00 €	● F026H3BB033	710,00 €	● F026H4BB033	710,00 €
Dali		Dali		Dali	
○ F026H2BD001	710,00 €	○ F026H3BD001	710,00 €	○ F026H4BD001	710,00 €
● F026H2BD006	710,00 €	● F026H3BD006	710,00 €	● F026H4BD006	710,00 €
● F026H2BD012	710,00 €	● F026H3BD012	710,00 €	● F026H4BD012	710,00 €
● F026H2BD018	710,00 €	● F026H3BD018	710,00 €	● F026H4BD018	710,00 €
● F026H2BD030	710,00 €	● F026H3BD030	710,00 €	● F026H4BD030	710,00 €
● F026H2BD033	710,00 €	● F026H3BD033	710,00 €	● F026H4BD033	710,00 €

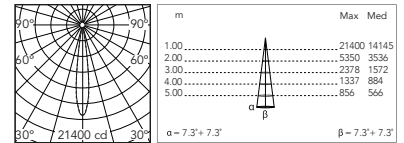

@ 3000K

Optic Medium Flood 26°

Power Led: 17W - 1739 lm ≠ FIXT 1336 lm - 2700K/CRI 80 - 220-240V / 17W - 1803 lm ≠ FIXT 1386 lm - 3000K/CRI 80 - 220-240V / 17W - 1868 lm ≠ FIXT 1434 lm - 4000K/CRI 80 - 220-240V

2700K		3000K		4000K	
Non Dimmable		Non Dimmable		Non Dimmable	
○ F026H2CA001	658,00 €	○ F026H3CA001	658,00 €	○ F026H4CA001	658,00 €
● F026H2CA006	658,00 €	● F026H3CA006	658,00 €	● F026H4CA006	658,00 €
● F026H2CA012	658,00 €	● F026H3CA012	658,00 €	● F026H4CA012	658,00 €
● F026H2CA018	658,00 €	● F026H3CA018	658,00 €	● F026H4CA018	658,00 €
● F026H2CA030	658,00 €	● F026H3CA030	658,00 €	● F026H4CA030	658,00 €
● F026H2CA033	658,00 €	● F026H3CA033	658,00 €	● F026H4CA033	658,00 €
1-10V		1-10V		1-10V	
○ F026H2CB001	710,00 €	○ F026H3CB001	710,00 €	○ F026H4CB001	710,00 €
● F026H2CB006	710,00 €	● F026H3CB006	710,00 €	● F026H4CB006	710,00 €
● F026H2CB012	710,00 €	● F026H3CB012	710,00 €	● F026H4CB012	710,00 €
● F026H2CB018	710,00 €	● F026H3CB018	710,00 €	● F026H4CB018	710,00 €
● F026H2CB030	710,00 €	● F026H3CB030	710,00 €	● F026H4CB030	710,00 €
● F026H2CB033	710,00 €	● F026H3CB033	710,00 €	● F026H4CB033	710,00 €
Dali		Dali		Dali	
○ F026H2CD001	710,00 €	○ F026H3CD001	710,00 €	○ F026H4CD001	710,00 €
● F026H2CD006	710,00 €	● F026H3CD006	710,00 €	● F026H4CD006	710,00 €
● F026H2CD012	710,00 €	● F026H3CD012	710,00 €	● F026H4CD012	710,00 €
● F026H2CD018	710,00 €	● F026H3CD018	710,00 €	● F026H4CD018	710,00 €
● F026H2CD030	710,00 €	● F026H3CD030	710,00 €	● F026H4CD030	710,00 €
● F026H2CD033	710,00 €	● F026H3CD033	710,00 €	● F026H4CD033	710,00 €

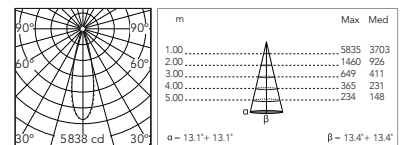

@ 3000K

Optic Flood 36°

Power Led: 17W - 1739 lm ≠ FIXT 1302 lm - 2700K/CRI 80 - 220-240V / 17W - 1803 lm ≠ FIXT 1351 lm - 3000K/CRI 80 - 220-240V / 17W - 1868 lm ≠ FIXT 1397 lm - 4000K/CRI 80 - 220-240V

2700K		3000K		4000K	
Non Dimmable		Non Dimmable		Non Dimmable	
○ F026H2DA001	658,00 €	○ F026H3DA001	658,00 €	○ F026H4DA001	658,00 €
● F026H2DA006	658,00 €	● F026H3DA006	658,00 €	● F026H4DA006	658,00 €
● F026H2DA012	658,00 €	● F026H3DA012	658,00 €	● F026H4DA012	658,00 €
● F026H2DA018	658,00 €	● F026H3DA018	658,00 €	● F026H4DA018	658,00 €
● F026H2DA030	658,00 €	● F026H3DA030	658,00 €	● F026H4DA030	658,00 €
● F026H2DA033	658,00 €	● F026H3DA033	658,00 €	● F026H4DA033	658,00 €
1-10V					
○ F026H2DB001	710,00 €	○ F026H3DB001	710,00 €	○ F026H4DB001	710,00 €
● F026H2DB006	710,00 €	● F026H3DB006	710,00 €	● F026H4DB006	710,00 €
● F026H2DB012	710,00 €	● F026H3DB012	710,00 €	● F026H4DB012	710,00 €
● F026H2DB018	710,00 €	● F026H3DB018	710,00 €	● F026H4DB018	710,00 €
● F026H2DB030	710,00 €	● F026H3DB030	710,00 €	● F026H4DB030	710,00 €
● F026H2DB033	710,00 €	● F026H3DB033	710,00 €	● F026H4DB033	710,00 €
Dali					
○ F026H2DD001	710,00 €	○ F026H3DD001	710,00 €	○ F026H4DD001	710,00 €
● F026H2DD006	710,00 €	● F026H3DD006	710,00 €	● F026H4DD006	710,00 €
● F026H2DD012	710,00 €	● F026H3DD012	710,00 €	● F026H4DD012	710,00 €
● F026H2DD018	710,00 €	● F026H3DD018	710,00 €	● F026H4DD018	710,00 €
● F026H2DD030	710,00 €	● F026H3DD030	710,00 €	● F026H4DD030	710,00 €
● F026H2DD033	710,00 €	● F026H3DD033	710,00 €	● F026H4DD033	710,00 €

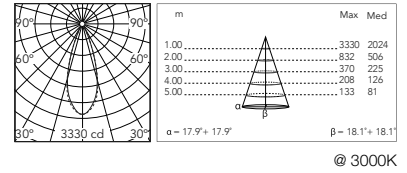

Optic Wide Flood 52°

Power Led: 17W - 1739 lm ≠ FIXT 1303 lm - 2700K/CRI 80 - 220-240V / 17W - 1803 lm ≠ FIXT 1357 lm - 3000K/CRI 80 - 220-240V / 17W - 1868 lm ≠ FIXT 1411 lm - 4000K/CRI 80 - 220-240V

2700K		3000K		4000K	
Non Dimmable		Non Dimmable		Non Dimmable	
○ F026H2EA001	658,00 €	○ F026H3EA001	658,00 €	○ F026H4EA001	658,00 €
● F026H2EA006	658,00 €	● F026H3EA006	658,00 €	● F026H4EA006	658,00 €
● F026H2EA012	658,00 €	● F026H3EA012	658,00 €	● F026H4EA012	658,00 €
● F026H2EA018	658,00 €	● F026H3EA018	658,00 €	● F026H4EA018	658,00 €
● F026H2EA030	658,00 €	● F026H3EA030	658,00 €	● F026H4EA030	658,00 €
● F026H2EA033	658,00 €	● F026H3EA033	658,00 €	● F026H4EA033	658,00 €
1-10V					
○ F026H2EB001	710,00 €	○ F026H3EB001	710,00 €	○ F026H4EB001	710,00 €
● F026H2EB006	710,00 €	● F026H3EB006	710,00 €	● F026H4EB006	710,00 €
● F026H2EB012	710,00 €	● F026H3EB012	710,00 €	● F026H4EB012	710,00 €
● F026H2EB018	710,00 €	● F026H3EB018	710,00 €	● F026H4EB018	710,00 €
● F026H2EB030	710,00 €	● F026H3EB030	710,00 €	● F026H4EB030	710,00 €
● F026H2EB033	710,00 €	● F026H3EB033	710,00 €	● F026H4EB033	710,00 €
Dali					
○ F026H2ED001	710,00 €	○ F026H3ED001	710,00 €	○ F026H4ED001	710,00 €
● F026H2ED006	710,00 €	● F026H3ED006	710,00 €	● F026H4ED006	710,00 €
● F026H2ED012	710,00 €	● F026H3ED012	710,00 €	● F026H4ED012	710,00 €
● F026H2ED018	710,00 €	● F026H3ED018	710,00 €	● F026H4ED018	710,00 €
● F026H2ED030	710,00 €	● F026H3ED030	710,00 €	● F026H4ED030	710,00 €
● F026H2ED033	710,00 €	● F026H3ED033	710,00 €	● F026H4ED033	710,00 €

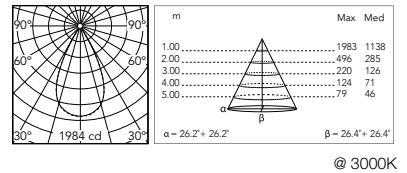

Optic Elliptical 1 14° x 50°

Power Led: 17W - 1739 lm ≠ FIXT 1315 lm - 2700K/CRI 80 - 220-240V / 17W - 1803 lm ≠ FIXT 1364 lm - 3000K/CRI 80 - 220-240V / 17W - 1868 lm ≠ FIXT 1410 lm - 4000K/CRI 80 - 220-240V

2700K		3000K		4000K	
Non Dimmable		Non Dimmable		Non Dimmable	
○ F026H2FA001	658,00 €	○ F026H3FA001	658,00 €	○ F026H4FA001	658,00 €
● F026H2FA006	658,00 €	● F026H3FA006	658,00 €	● F026H4FA006	658,00 €
● F026H2FA012	658,00 €	● F026H3FA012	658,00 €	● F026H4FA012	658,00 €
● F026H2FA018	658,00 €	● F026H3FA018	658,00 €	● F026H4FA018	658,00 €
● F026H2FA030	658,00 €	● F026H3FA030	658,00 €	● F026H4FA030	658,00 €
● F026H2FA033	658,00 €	● F026H3FA033	658,00 €	● F026H4FA033	658,00 €
1-10V					
○ F026H2FB001	710,00 €	○ F026H3FB001	710,00 €	○ F026H4FB001	710,00 €
● F026H2FB006	710,00 €	● F026H3FB006	710,00 €	● F026H4FB006	710,00 €
● F026H2FB012	710,00 €	● F026H3FB012	710,00 €	● F026H4FB012	710,00 €
● F026H2FB018	710,00 €	● F026H3FB018	710,00 €	● F026H4FB018	710,00 €
● F026H2FB030	710,00 €	● F026H3FB030	710,00 €	● F026H4FB030	710,00 €
● F026H2FB033	710,00 €	● F026H3FB033	710,00 €	● F026H4FB033	710,00 €
Dali					
○ F026H2FD001	710,00 €	○ F026H3FD001	710,00 €	○ F026H4FD001	710,00 €
● F026H2FD006	710,00 €	● F026H3FD006	710,00 €	● F026H4FD006	710,00 €
● F026H2FD012	710,00 €	● F026H3FD012	710,00 €	● F026H4FD012	710,00 €
● F026H2FD018	710,00 €	● F026H3FD018	710,00 €	● F026H4FD018	710,00 €
● F026H2FD030	710,00 €	● F026H3FD030	710,00 €	● F026H4FD030	710,00 €
● F026H2FD033	710,00 €	● F026H3FD033	710,00 €	● F026H4FD033	710,00 €

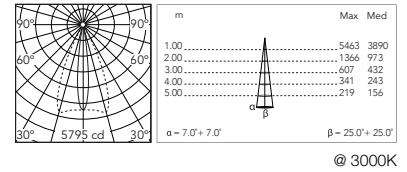

Spine F 2 Ultra Hp

Optic Elliptical 2 25° x 52°

Power Led: 17W - 1739 lm ≠ FIXT 1298 lm - 2700K/CRI 80 - 220-240V / 17W - 1803 lm ≠ FIXT 1351 lm - 3000K/CRI 80 - 220-240V / 17W - 1868 lm ≠ FIXT 1393 lm - 4000K/CRI 80 - 220-240V

2700K

Non Dimmable

- F026H2GA001 658,00 €
- F026H2GA006 658,00 €
- F026H2GA012 658,00 €
- F026H2GA018 658,00 €
- F026H2GA030 658,00 €
- F026H2GA033 658,00 €

1-10V

- F026H2GB001 710,00 €
- F026H2GB006 710,00 €
- F026H2GB012 710,00 €
- F026H2GB018 710,00 €
- F026H2GB030 710,00 €
- F026H2GB033 710,00 €

Dali

- F026H2GD001 710,00 €
- F026H2GD006 710,00 €
- F026H2GD012 710,00 €
- F026H2GD018 710,00 €
- F026H2GD030 710,00 €
- F026H2GD033 710,00 €

3000K

Non Dimmable

- F026H3GA001 658,00 €
- F026H3GA006 658,00 €
- F026H3GA012 658,00 €
- F026H3GA018 658,00 €
- F026H3GA030 658,00 €
- F026H3GA033 658,00 €

1-10V

- F026H3GB001 710,00 €
- F026H3GB006 710,00 €
- F026H3GB012 710,00 €
- F026H3GB018 710,00 €
- F026H3GB030 710,00 €
- F026H3GB033 710,00 €

Dali

- F026H3GD001 710,00 €
- F026H3GD006 710,00 €
- F026H3GD012 710,00 €
- F026H3GD018 710,00 €
- F026H3GD030 710,00 €
- F026H3GD033 710,00 €

4000K

Non Dimmable

- F026H4GA001 658,00 €
- F026H4GA006 658,00 €
- F026H4GA012 658,00 €
- F026H4GA018 658,00 €
- F026H4GA030 658,00 €
- F026H4GA033 658,00 €

1-10V

- F026H4GB001 710,00 €
- F026H4GB006 710,00 €
- F026H4GB012 710,00 €
- F026H4GB018 710,00 €
- F026H4GB030 710,00 €
- F026H4GB033 710,00 €

Dali

- F026H4GD001 710,00 €
- F026H4GD006 710,00 €
- F026H4GD012 710,00 €
- F026H4GD018 710,00 €
- F026H4GD030 710,00 €
- F026H4GD033 710,00 €

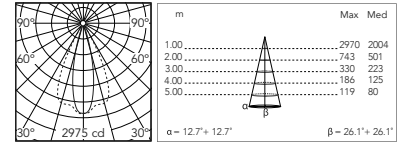

@ 3000K

Optic Wall Washer

Power Led: 17W - 1739 lm ≠ FIXT 1277 lm - 2700K/CRI 80 - 220-240V / 17W - 1803 lm ≠ FIXT 1325 lm - 3000K/CRI 80 - 220-240V / 17W - 1868 lm ≠ FIXT 1370 lm - 4000K/CRI 80 - 220-240V

2700K

Non Dimmable

- F026H2HA001 658,00 €
- F026H2HA006 658,00 €
- F026H2HA012 658,00 €
- F026H2HA018 658,00 €
- F026H2HA030 658,00 €
- F026H2HA033 658,00 €

1-10V

- F026H2HB001 710,00 €
- F026H2HB006 710,00 €
- F026H2HB012 710,00 €
- F026H2HB018 710,00 €
- F026H2HB030 710,00 €
- F026H2HB033 710,00 €

Dali

- F026H2HD001 710,00 €
- F026H2HD006 710,00 €
- F026H2HD012 710,00 €
- F026H2HD018 710,00 €
- F026H2HD030 710,00 €
- F026H2HD033 710,00 €

3000K

Non Dimmable

- F026H3HA001 658,00 €
- F026H3HA006 658,00 €
- F026H3HA012 658,00 €
- F026H3HA018 658,00 €
- F026H3HA030 658,00 €
- F026H3HA033 658,00 €

1-10V

- F026H3HB001 710,00 €
- F026H3HB006 710,00 €
- F026H3HB012 710,00 €
- F026H3HB018 710,00 €
- F026H3HB030 710,00 €
- F026H3HB033 710,00 €

Dali

- F026H3HD001 710,00 €
- F026H3HD006 710,00 €
- F026H3HD012 710,00 €
- F026H3HD018 710,00 €
- F026H3HD030 710,00 €
- F026H3HD033 710,00 €

4000K

Non Dimmable

- F026H4HA001 658,00 €
- F026H4HA006 658,00 €
- F026H4HA012 658,00 €
- F026H4HA018 658,00 €
- F026H4HA030 658,00 €
- F026H4HA033 658,00 €

1-10V

- F026H4HB001 710,00 €
- F026H4HB006 710,00 €
- F026H4HB012 710,00 €
- F026H4HB018 710,00 €
- F026H4HB030 710,00 €
- F026H4HB033 710,00 €





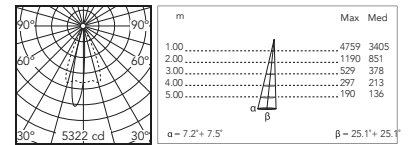





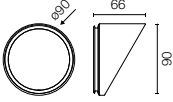

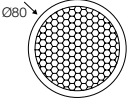

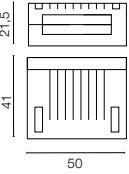

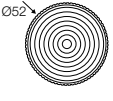
Dali

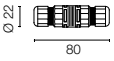
- F026H4HD001 710,00 €
- F026H4HD006 710,00 €
- F026H4HD012 710,00 €
- F026H4HD018 710,00 €
- F026H4HD030 710,00 €
- F026H4HD033 710,00 €

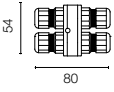

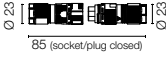
@ 3000K

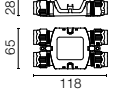
Spine F 2 Ultra: Accessoires / Accessories

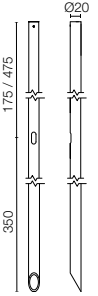
Visueur	Visor	<ul style="list-style-type: none"> ○ F026Z050001 57,00 € ● F026Z050006 57,00 € ● F026Z050012 57,00 € ● F026Z050018 57,00 € ● F026Z050030 57,00 € ● F026Z050033 57,00 € 		 
Honeycomb	Honeycomb Louvre	F026Z060000	21,00 €	 
Gelbox IPX8 pour le raccordement électrique.	Gelbox IPX8 for splicing connectors.	F990C110000	22,00 €	 
Lentilles de conversion / Converter lenses:				
- Converter Spine 2 Optic Medium Flood		F029Z020000	37,00 €	 
- Converter Spine 2 Optic Flood		F029Z021000	37,00 €	
- Converter Spine 2 Optic Wide Flood		F029Z022000	37,00 €	
- Converter Spine 2 Optic Elliptic 1		F029Z023000	37,00 €	
- Converter Spine 2 Optic Elliptic 2		F029Z024000	37,00 €	
- Converter Spine 2 Optic Wall Washer		F029Z025000	37,00 €	
Système de jonction IP68 H2O Stop anti-condensation à 2 voies 4 pôles.	2 way terminal block 4 poles IP68 H2O Stop.	F990C00A000	33,00 €	 
Système de jonction IP68 H2O Stop anti-condensation à 3/4 voies 4 pôles. (Ø5,5÷12mm câble).	3/4 way terminal block 4 poles IP68 H2O Stop. (ø5,5÷12mm cable).	F990C010000	60,00 €	 
Kit de connecteurs à 5 pôles: fiche volante + fiche EU IP68.	Connector kit 5-pole flying socket + EU plug IP68.	F990C080000	48,00 €	 
Boitier de dérivation 5 pôles 4 voies (câbles 6-14 mm).	4 way junction box 5 poles IP68 (6-14 mm cables).	F990C030000	62,00 €	 
Poteau longueur 200 - 500 mm au-dessus du sol pour des installations au sol.	Pole with an overground length of 200 - 500 mm for ground installation.	200 mm <ul style="list-style-type: none"> ○ F026Z020001 51,00 € ● F026Z020006 51,00 € ● F026Z020012 51,00 € ● F026Z020018 51,00 € ● F026Z020030 51,00 € ● F026Z020033 51,00 € 500 mm <ul style="list-style-type: none"> ○ F026Z030001 55,00 € ● F026Z030006 55,00 € ● F026Z030012 55,00 € ● F026Z030018 55,00 € ● F026Z030030 55,00 € ● F026Z030033 55,00 € 		 



Spine L

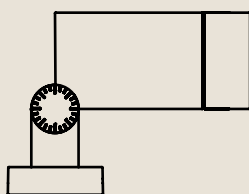

L'option de support en L permet une connexion plus facile grâce à la possibilité d'une entrée de câble latérale ainsi qu'une taille minimale pour répondre à toutes les exigences.

The L bracket option allows for an easier connection thanks to the possibility of a side cable entry as well as minimal size to meet any exigencies.

Spine L 1 Absolute

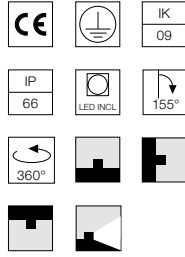
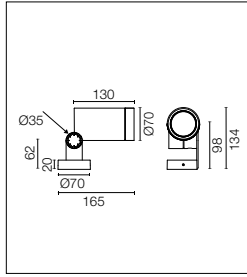

Source LED COB intégrée.
Source d'alimentation électrique intégrée 220-240V ON/OFF.
Support de montage minimum en L intégré. Équipée d'un câble en néoprène de 5m (10m sur commande) pour une connexion à distance; pour garantir l'étanchéité, il est conseillé d'utiliser des câbles flexibles conçus pour l'extérieur.
Sur demande, version réglable 1-10V ou DALI avec source d'alimentation à distance 24Vdc.

LED COB light source integrated. Integrated electric power supply 220-240V ON/OFF.
Minimum L-shaped mounting support integrated. Equipped with a 5m neoprene cable (10m upon request) for remote connection. To guarantee its water tightness, it is recommended to use flexible cables designed for outdoor use.
Upon request: 1-10V or DALI dimmable version with 24Vdc remote power supply.

Optic Spot 15°

CoB Led: 11W - 1247 lm ≠ FIXT 923 lm - 2700K/CRI 80 - 220-240V / 11W - 1325 lm ≠ FIXT 982 lm - 3000K/CRI 80 - 220-240V / 11W - 1364 lm ≠ FIXT 1011 lm - 4000K/CRI 80 - 220-240V

2700K

Non Dimmable

○ F025Q2BA001	428,00 €
● F025Q2BA006	428,00 €
● F025Q2BA012	428,00 €
● F025Q2BA018	428,00 €
● F025Q2BA030	428,00 €
● F025Q2BA033	428,00 €

3000K

Non Dimmable

○ F025Q3BA001	428,00 €
● F025Q3BA006	428,00 €
● F025Q3BA012	428,00 €
● F025Q3BA018	428,00 €
● F025Q3BA030	428,00 €
● F025Q3BA033	428,00 €

4000K

Non Dimmable

○ F025Q4BA001	428,00 €
● F025Q4BA006	428,00 €
● F025Q4BA012	428,00 €
● F025Q4BA018	428,00 €
● F025Q4BA030	428,00 €
● F025Q4BA033	428,00 €

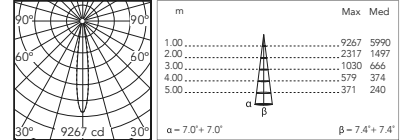

@ 3000K

Optic Medium Flood 33°

CoB Led: 11W - 1247 lm ≠ FIXT 906 lm - 2700K/CRI 80 - 220-240V / 11W - 1325 lm ≠ FIXT 964 lm - 3000K/CRI 80 - 220-240V / 11W - 1364 lm ≠ FIXT 993 lm - 4000K/CRI 80 - 220-240V

2700K

Non Dimmable

○ F025Q2CA001	428,00 €
● F025Q2CA006	428,00 €
● F025Q2CA012	428,00 €
● F025Q2CA018	428,00 €
● F025Q2CA030	428,00 €
● F025Q2CA033	428,00 €

3000K

Non Dimmable

○ F025Q3CA001	428,00 €
● F025Q3CA006	428,00 €
● F025Q3CA012	428,00 €
● F025Q3CA018	428,00 €
● F025Q3CA030	428,00 €
● F025Q3CA033	428,00 €

4000K

Non Dimmable

○ F025Q4CA001	428,00 €
● F025Q4CA006	428,00 €
● F025Q4CA012	428,00 €
● F025Q4CA018	428,00 €
● F025Q4CA030	428,00 €
● F025Q4CA033	428,00 €

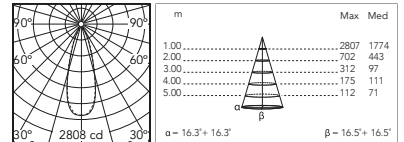

@ 3000K

Spine L 1 / L 2 Absolute: Accessoires / Accessories

Honeycomb	Honeycomb Louvre	Spine L 1 F025Z060000	20,00 €		
Honeycomb	Honeycomb Louvre	Spine L 2 F026Z060000	21,00 €		
Gelbox IPX8 pour le raccordement électrique.	Gelbox IPX8 for splicing connectors.	Spine L 1 F990C100000	14,00 €		
Gelbox IPX8 pour le raccordement électrique.	Gelbox IPX8 for splicing connectors.	Spine L 2 F990C110000	22,00 €		

Spine L 1 / L 2 Absolute: Accessoires pour les versions non dimmables / Accessories for non-dimmable versions

Système de jonction IP68 H2O Stop anti-condensation à 2 voies 4 pôles.	2 way terminal block 4 poles IP68 H2O Stop.	F990C00A000	33,00 €		
Système de jonction IP68 H2O Stop anti-condensation à 3/4 voies 4 pôles. (Ø5,5÷12mm câble).	3/4 way terminal block 4 poles IP68 H2O Stop. (Ø5,5÷12mm cable).	F990C010000	60,00 €		

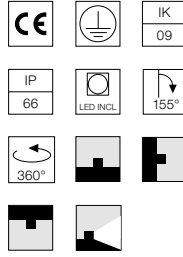
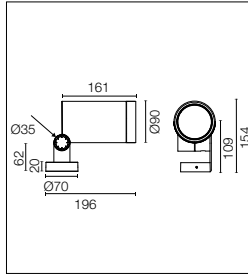

Source LED COB intégrée. Source d'alimentation électrique intégrée 220-240V ON/OFF et réglable 1-10V ou DALI. Support de montage minimum en L intégré. Équipée d'un câble en néoprène de 5m (10m sur commande) pour une connexion à distance; pour garantir l'étanchéité, il est conseillé d'utiliser des câbles flexibles conçus pour l'extérieur.

LED COB light source integrated. Integrated electric power supply 220-240V ON/OFF and adjustable 1-10V or DALI. Minimum L-shaped mounting support integrated. Equipped with a 5m neoprene cable (10m upon request) for remote connection. To guarantee its water tightness, it is recommended to use flexible cables designed for outdoor use.

Optic Spot 22°

CoB Led: 19,5W - 2197 lm ≠ FIXT 1939 lm - 2700K/CRI 80 - 220-240V / 19,5W - 2367 lm ≠ FIXT 2085 lm - 3000K/CRI 80 - 220-240V / 19,5W - 2497 lm ≠ FIXT 2120 lm - 4000K/CRI 80 - 220-240V

2700K		3000K		4000K	
Non Dimmable		Non Dimmable		Non Dimmable	
○ F026Q2BA001.A	564,00 €	○ F026Q3BA001	564,00 €	○ F026Q4BA001.A	564,00 €
● F026Q2BA006.A	564,00 €	● F026Q3BA006	564,00 €	● F026Q4BA006.A	564,00 €
● F026Q2BA012.A	564,00 €	● F026Q3BA012	564,00 €	● F026Q4BA012.A	564,00 €
● F026Q2BA018.A	564,00 €	● F026Q3BA018	564,00 €	● F026Q4BA018.A	564,00 €
● F026Q2BA030.A	564,00 €	● F026Q3BA030	564,00 €	● F026Q4BA030.A	564,00 €
● F026Q2BA033.A	564,00 €	● F026Q3BA033	564,00 €	● F026Q4BA033.A	564,00 €
1-10V		1-10V		1-10V	
○ F026Q2BB001.A	606,00 €	○ F026Q3BB001	606,00 €	○ F026Q4BB001.A	606,00 €
● F026Q2BB006.A	606,00 €	● F026Q3BB006	606,00 €	● F026Q4BB006.A	606,00 €
● F026Q2BB012.A	606,00 €	● F026Q3BB012	606,00 €	● F026Q4BB012.A	606,00 €
● F026Q2BB018.A	606,00 €	● F026Q3BB018	606,00 €	● F026Q4BB018.A	606,00 €
● F026Q2BB030.A	606,00 €	● F026Q3BB030	606,00 €	● F026Q4BB030.A	606,00 €
● F026Q2BB033.A	606,00 €	● F026Q3BB033	606,00 €	● F026Q4BB033.A	606,00 €
Dali		Dali		Dali	
○ F026Q2BD001.A	606,00 €	○ F026Q3BD001	606,00 €	○ F026Q4BD001.A	606,00 €
● F026Q2BD006.A	606,00 €	● F026Q3BD006	606,00 €	● F026Q4BD006.A	606,00 €
● F026Q2BD012.A	606,00 €	● F026Q3BD012	606,00 €	● F026Q4BD012.A	606,00 €
● F026Q2BD018.A	606,00 €	● F026Q3BD018	606,00 €	● F026Q4BD018.A	606,00 €
● F026Q2BD030.A	606,00 €	● F026Q3BD030	606,00 €	● F026Q4BD030.A	606,00 €
● F026Q2BD033.A	606,00 €	● F026Q3BD033	606,00 €	● F026Q4BD033.A	606,00 €

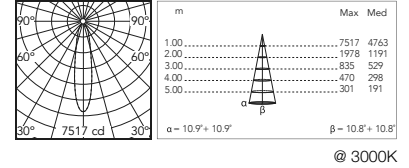

Optic Medium Flood 43°

CoB Led: 19,5W - 2197 lm ≠ FIXT 2026 lm - 2700K/CRI 80 - 220-240V / 19,5W - 2367 lm ≠ FIXT 2178 lm - 3000K/CRI 80 - 220-240V / 19,5W - 2497 lm ≠ FIXT 2298 lm - 4000K/CRI 80 - 220-240V

2700K		3000K		4000K	
Non Dimmable		Non Dimmable		Non Dimmable	
○ F026Q2CA001.A	564,00 €	○ F026Q3CA001	564,00 €	○ F026Q4CA001.A	564,00 €
● F026Q2CA006.A	564,00 €	● F026Q3CA006	564,00 €	● F026Q4CA006.A	564,00 €
● F026Q2CA012.A	564,00 €	● F026Q3CA012	564,00 €	● F026Q4CA012.A	564,00 €
● F026Q2CA018.A	564,00 €	● F026Q3CA018	564,00 €	● F026Q4CA018.A	564,00 €
● F026Q2CA030.A	564,00 €	● F026Q3CA030	564,00 €	● F026Q4CA030.A	564,00 €
● F026Q2CA033.A	564,00 €	● F026Q3CA033	564,00 €	● F026Q4CA033.A	564,00 €
1-10V		1-10V		1-10V	
○ F026Q2CB001.A	606,00 €	○ F026Q3CB001	606,00 €	○ F026Q4CB001.A	606,00 €
● F026Q2CB006.A	606,00 €	● F026Q3CB006	606,00 €	● F026Q4CB006.A	606,00 €
● F026Q2CB012.A	606,00 €	● F026Q3CB012	606,00 €	● F026Q4CB012.A	606,00 €
● F026Q2CB018.A	606,00 €	● F026Q3CB018	606,00 €	● F026Q4CB018.A	606,00 €
● F026Q2CB030.A	606,00 €	● F026Q3CB030	606,00 €	● F026Q4CB030.A	606,00 €
● F026Q2CB033.A	606,00 €	● F026Q3CB033	606,00 €	● F026Q4CB033.A	606,00 €
Dali		Dali		Dali	
○ F026Q2CD001.A	606,00 €	○ F026Q3CD001	606,00 €	○ F026Q4CD001.A	606,00 €
● F026Q2CD006.A	606,00 €	● F026Q3CD006	606,00 €	● F026Q4CD006.A	606,00 €
● F026Q2CD012.A	606,00 €	● F026Q3CD012	606,00 €	● F026Q4CD012.A	606,00 €
● F026Q2CD018.A	606,00 €	● F026Q3CD018	606,00 €	● F026Q4CD018.A	606,00 €
● F026Q2CD030.A	606,00 €	● F026Q3CD030	606,00 €	● F026Q4CD030.A	606,00 €
● F026Q2CD033.A	606,00 €	● F026Q3CD033	606,00 €	● F026Q4CD033.A	606,00 €

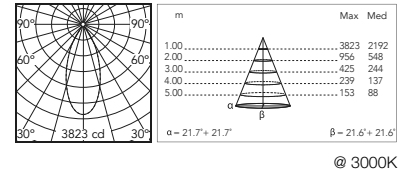

Spine L 2 Absolute: Accessoires pour les versions dimmables / Accessories for dimmable versions

Kit de connecteurs à 5 pôles: fiche volante + fiche EU IP68.	Connector kit 5-pole flying socket + EU plug IP68.	F990C080000	48,00 €	
Boîtier de dérivation 5 pôles 4 voies (câbles 6-14 mm).	4 way junction box 5 poles IP68 (6-14 mm cables).	F990C030000	62,00 €	

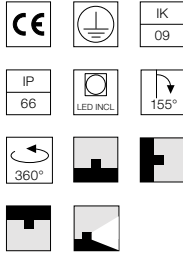
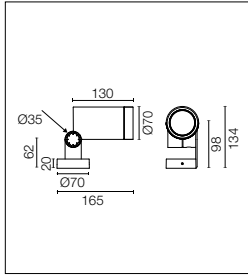

Source Power LED incluse. Équipée d'un snoot intégré pour un plus grand confort visuel. Les collimateurs sont des accessoires disponibles pour modifier la largeur du faisceau lumineux. Source d'alimentation électrique intégrée 220-240V ON/OFF. Support de montage minimum en L intégré. Équipée d'un câble en néoprène de 5m (10m sur commande) pour une connexion à distance; pour garantir l'étanchéité, il est conseillé d'utiliser des câbles flexibles conçus pour l'extérieur. Sur demande, version réglable 1-10V ou DALI avec source d'alimentation à distance 24Vdc.

Power LED source included. Equipped with an integrated snoot for higher visual comfort. Collimators are available as an accessory to modify the beam opening. Integrated electric power supply 220-240V ON/OFF. Minimum L-shaped mounting support integrated. Equipped with a 5m neoprene cable (10m upon request) for remote connection. To guarantee its water tightness, it is recommended to use flexible cables designed for outdoor use. Upon request: 1-10V or DALI dimmable version with 24Vdc remote power supply.

2200K disponible sur demande.

2200K available on request.

Optic Narrow Spot 7°

Power Led: 3,5W - 168 lm ≠ FIXT 143 lm - 2700K/CRI 80 - 220-240V / 3,5W - 174 lm ≠ FIXT 149 lm - 3000K/CRI 80 - 220-240V / 3,5W - 180 lm ≠ FIXT 154 lm - 4000K/CRI 80 - 220-240V

2700K

Non Dimmable

- F025V2AA001 616,00 €
- F025V2AA006 616,00 €
- F025V2AA012 616,00 €
- F025V2AA018 616,00 €
- F025V2AA030 616,00 €
- F025V2AA033 616,00 €

3000K

Non Dimmable

- F025V3AA001 616,00 €
- F025V3AA006 616,00 €
- F025V3AA012 616,00 €
- F025V3AA018 616,00 €
- F025V3AA030 616,00 €
- F025V3AA033 616,00 €

4000K

Non Dimmable

- F025V4AA001 616,00 €
- F025V4AA006 616,00 €
- F025V4AA012 616,00 €
- F025V4AA018 616,00 €
- F025V4AA030 616,00 €
- F025V4AA033 616,00 €

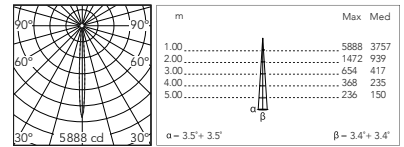

@ 3000K

Optic Spot 14°

Power Led: 7,9W - 671 lm ≠ FIXT 550 lm - 2700K/CRI 80 - 220-240V / 7,9W - 696 lm ≠ FIXT 571 lm - 3000K/CRI 80 - 220-240V / 7,9W - 720 lm ≠ FIXT 591 lm - 4000K/CRI 80 - 220-240V

2700K

Non Dimmable

- F025V2BA001 616,00 €
- F025V2BA006 616,00 €
- F025V2BA012 616,00 €
- F025V2BA018 616,00 €
- F025V2BA030 616,00 €
- F025V2BA033 616,00 €

3000K

Non Dimmable

- F025V3BA001 616,00 €
- F025V3BA006 616,00 €
- F025V3BA012 616,00 €
- F025V3BA018 616,00 €
- F025V3BA030 616,00 €
- F025V3BA033 616,00 €

4000K

Non Dimmable

- F025V4BA001 616,00 €
- F025V4BA006 616,00 €
- F025V4BA012 616,00 €
- F025V4BA018 616,00 €
- F025V4BA030 616,00 €
- F025V4BA033 616,00 €

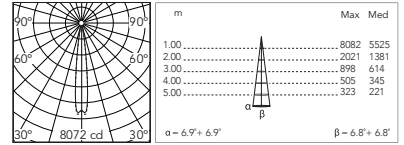

@ 3000K

Optic Medium Flood 24,5°

Power Led: 7,9W - 671 lm ≠ FIXT 499 lm - 2700K/CRI 80 - 220-240V / 7,9W - 696 lm ≠ FIXT 518 lm - 3000K/CRI 80 - 220-240V / 7,9W - 720 lm ≠ FIXT 536 lm - 4000K/CRI 80 - 220-240V

2700K

Non Dimmable

- F025V2CA001 616,00 €
- F025V2CA006 616,00 €
- F025V2CA012 616,00 €
- F025V2CA018 616,00 €
- F025V2CA030 616,00 €
- F025V2CA033 616,00 €

3000K

Non Dimmable

- F025V3CA001 616,00 €
- F025V3CA006 616,00 €
- F025V3CA012 616,00 €
- F025V3CA018 616,00 €
- F025V3CA030 616,00 €
- F025V3CA033 616,00 €

4000K

Non Dimmable

- F025V4CA001 616,00 €
- F025V4CA006 616,00 €
- F025V4CA012 616,00 €
- F025V4CA018 616,00 €
- F025V4CA030 616,00 €
- F025V4CA033 616,00 €

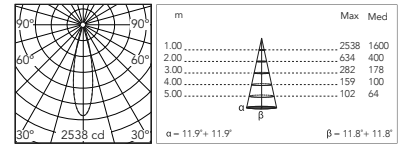

@ 3000K

Optic Flood 32°

Power Led: 7,9W - 671 lm ≠ FIXT 482 lm - 2700K/CRI 80 - 220-240V / 7,9W - 696 lm ≠ FIXT 500 lm - 3000K/CRI 80 - 220-240V / 7,9W - 720 lm ≠ FIXT 518 lm - 4000K/CRI 80 - 220-240V

2700K

Non Dimmable

- F025V2DA001 616,00 €
- F025V2DA006 616,00 €
- F025V2DA012 616,00 €
- F025V2DA018 616,00 €
- F025V2DA030 616,00 €
- F025V2DA033 616,00 €

3000K

Non Dimmable

- F025V3DA001 616,00 €
- F025V3DA006 616,00 €
- F025V3DA012 616,00 €
- F025V3DA018 616,00 €
- F025V3DA030 616,00 €
- F025V3DA033 616,00 €

4000K

Non Dimmable

- F025V4DA001 616,00 €
- F025V4DA006 616,00 €
- F025V4DA012 616,00 €
- F025V4DA018 616,00 €
- F025V4DA030 616,00 €
- F025V4DA033 616,00 €

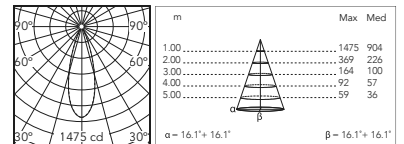

@ 3000K

Optic Wide Flood 49°

Power Led: 7,9W - 671 lm ≠ FIXT 480 lm - 2700K/CRI 80 - 220-240V / 7,9W - 696 lm ≠ FIXT 490 lm - 3000K/CRI 80 - 220-240V / 7,9W - 720 lm ≠ FIXT 505 lm - 4000K/CRI 80 - 220-240V

2700K		3000K		4000K	
Non Dimmable		Non Dimmable		Non Dimmable	
○ F025V2EA001	616,00 €	○ F025V3EA001	616,00 €	○ F025V4EA001	616,00 €
● F025V2EA006	616,00 €	● F025V3EA006	616,00 €	● F025V4EA006	616,00 €
● F025V2EA012	616,00 €	● F025V3EA012	616,00 €	● F025V4EA012	616,00 €
● F025V2EA018	616,00 €	● F025V3EA018	616,00 €	● F025V4EA018	616,00 €
● F025V2EA030	616,00 €	● F025V3EA030	616,00 €	● F025V4EA030	616,00 €
● F025V2EA033	616,00 €	● F025V3EA033	616,00 €	● F025V4EA033	616,00 €

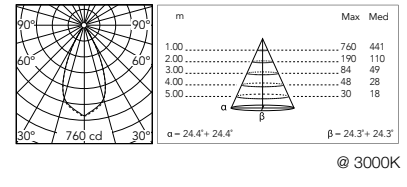

Optic Elliptical 1 13,5° x 50°

Power Led: 7,9W - 671 lm ≠ FIXT 500 lm - 2700K/CRI 80 - 220-240V / 7,9W - 696 lm ≠ FIXT 519 lm - 3000K/CRI 80 - 220-240V / 7,9W - 720 lm ≠ FIXT 537 lm - 4000K/CRI 80 - 220-240V

2700K		3000K		4000K	
Non Dimmable		Non Dimmable		Non Dimmable	
○ F025V2FA001	616,00 €	○ F025V3FA001	616,00 €	○ F025V4FA001	616,00 €
● F025V2FA006	616,00 €	● F025V3FA006	616,00 €	● F025V4FA006	616,00 €
● F025V2FA012	616,00 €	● F025V3FA012	616,00 €	● F025V4FA012	616,00 €
● F025V2FA018	616,00 €	● F025V3FA018	616,00 €	● F025V4FA018	616,00 €
● F025V2FA030	616,00 €	● F025V3FA030	616,00 €	● F025V4FA030	616,00 €
● F025V2FA033	616,00 €	● F025V3FA033	616,00 €	● F025V4FA033	616,00 €

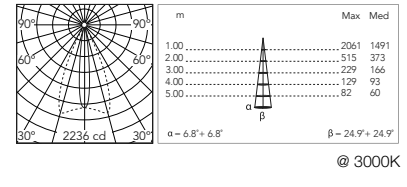

Optic Elliptical 2 26° x 51°

Power Led: 7,9W - 671 lm ≠ FIXT 487 lm - 2700K/CRI 80 - 220-240V / 7,9W - 696 lm ≠ FIXT 505 lm - 3000K/CRI 80 - 220-240V / 7,9W - 720 lm ≠ FIXT 523 lm - 4000K/CRI 80 - 220-240V

2700K		3000K		4000K	
Non Dimmable		Non Dimmable		Non Dimmable	
○ F025V2GA001	616,00 €	○ F025V3GA001	616,00 €	○ F025V4GA001	616,00 €
● F025V2GA006	616,00 €	● F025V3GA006	616,00 €	● F025V4GA006	616,00 €
● F025V2GA012	616,00 €	● F025V3GA012	616,00 €	● F025V4GA012	616,00 €
● F025V2GA018	616,00 €	● F025V3GA018	616,00 €	● F025V4GA018	616,00 €
● F025V2GA030	616,00 €	● F025V3GA030	616,00 €	● F025V4GA030	616,00 €
● F025V2GA033	616,00 €	● F025V3GA033	616,00 €	● F025V4GA033	616,00 €

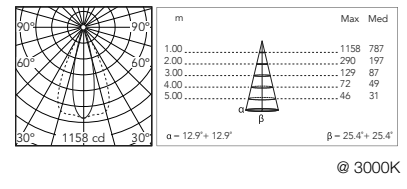

Optic Wall Washer

Power Led: 7,9W - 671 lm ≠ FIXT 471 lm - 2700K/CRI 80 - 220-240V / 7,9W - 696 lm ≠ FIXT 489 lm - 3000K/CRI 80 - 220-240V / 7,9W - 720 lm ≠ FIXT 506 lm - 4000K/CRI 80 - 220-240V

2700K		3000K		4000K	
Non Dimmable		Non Dimmable		Non Dimmable	
○ F025V2HA001	616,00 €	○ F025V3HA001	616,00 €	○ F025V4HA001	616,00 €
● F025V2HA006	616,00 €	● F025V3HA006	616,00 €	● F025V4HA006	616,00 €
● F025V2HA012	616,00 €	● F025V3HA012	616,00 €	● F025V4HA012	616,00 €
● F025V2HA018	616,00 €	● F025V3HA018	616,00 €	● F025V4HA018	616,00 €
● F025V2HA030	616,00 €	● F025V3HA030	616,00 €	● F025V4HA030	616,00 €
● F025V2HA033	616,00 €	● F025V3HA033	616,00 €	● F025V4HA033	616,00 €

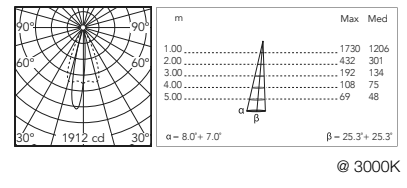

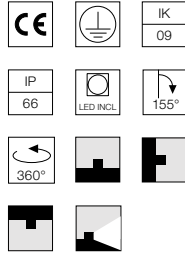
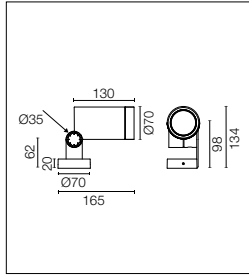

Source LED à basse consommation incluse. Équipée d'un snoot intégré pour un plus grand confort visuel. Les collimateurs sont des accessoires disponibles pour modifier la largeur du faisceau lumineux. Source d'alimentation électrique intégrée 220-240V ON/OFF. Support de montage minimum en L intégré. Équipée d'un câble en néoprène de 5m (10m sur commande) pour une connexion à distance; pour garantir l'étanchéité, il est conseillé d'utiliser des câbles flexibles conçus pour l'extérieur. Sur demande, version réglable 1-10V ou DALI avec source d'alimentation à distance 24Vdc.

Energy-efficient Power LED source included Equipped with an integrated snoot for higher visual comfort. Collimators are available as an accessory to modify the beam opening. Integrated electric power supply 220-240V ON/OFF. Minimum L-shaped mounting support integrated. Equipped with a 5m neoprene cable (10m upon request) for remote connection. To guarantee its water tightness, it is recommended to use flexible cables designed for outdoor use. Upon request: 1-10V or DALI dimmable version with 24Vdc remote power supply.

Optic Spot 12°

Power Led: 10,5W - 920 lm ≠ FIXT 680 lm - 2700K/CRI 80 - 220-240V / 10,5W - 966 lm ≠ FIXT 706 lm - 3000K/CRI 80 - 220-240V / 10,5W - 1012 lm ≠ FIXT 730 lm - 4000K/CRI 80 - 220-240V

2700K

Non Dimmable

- F025W2BA001 616,00 €
- F025W2BA006 616,00 €
- F025W2BA012 616,00 €
- F025W2BA018 616,00 €
- F025W2BA030 616,00 €
- F025W2BA033 616,00 €

3000K

Non Dimmable

- F025W3BA001 616,00 €
- F025W3BA006 616,00 €
- F025W3BA012 616,00 €
- F025W3BA018 616,00 €
- F025W3BA030 616,00 €
- F025W3BA033 616,00 €

4000K

Non Dimmable

- F025W4BA001 616,00 €
- F025W4BA006 616,00 €
- F025W4BA012 616,00 €
- F025W4BA018 616,00 €
- F025W4BA030 616,00 €
- F025W4BA033 616,00 €

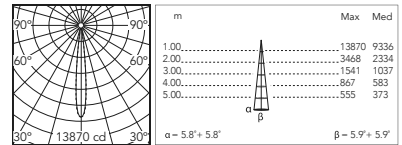

@ 3000K

Optic Medium Flood 26,5°

Power Led: 10,5W - 920 lm ≠ FIXT 594 lm - 2700K/CRI 80 - 220-240V / 10,5W - 966 lm ≠ FIXT 630 lm - 3000K/CRI 80 - 220-240V / 10,5W - 1012 lm ≠ FIXT 654 lm - 4000K/CRI 80 - 220-240V

2700K

Non Dimmable

- F025W2CA001 616,00 €
- F025W2CA006 616,00 €
- F025W2CA012 616,00 €
- F025W2CA018 616,00 €
- F025W2CA030 616,00 €
- F025W2CA033 616,00 €

3000K

Non Dimmable

- F025W3CA001 616,00 €
- F025W3CA006 616,00 €
- F025W3CA012 616,00 €
- F025W3CA018 616,00 €
- F025W3CA030 616,00 €
- F025W3CA033 616,00 €

4000K

Non Dimmable

- F025W4CA001 616,00 €
- F025W4CA006 616,00 €
- F025W4CA012 616,00 €
- F025W4CA018 616,00 €
- F025W4CA030 616,00 €
- F025W4CA033 616,00 €

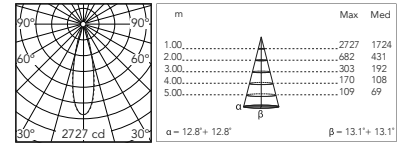

@ 3000K

Optic Flood 33,5°

Power Led: 10,5W - 920 lm ≠ FIXT 592 lm - 2700K/CRI 80 - 220-240V / 10,5W - 966 lm ≠ FIXT 627 lm - 3000K/CRI 80 - 220-240V / 10,5W - 1012 lm ≠ FIXT 651 lm - 4000K/CRI 80 - 220-240V

2700K

Non Dimmable

- F025W2DA001 616,00 €
- F025W2DA006 616,00 €
- F025W2DA012 616,00 €
- F025W2DA018 616,00 €
- F025W2DA030 616,00 €
- F025W2DA033 616,00 €

3000K

Non Dimmable

- F025W3DA001 616,00 €
- F025W3DA006 616,00 €
- F025W3DA012 616,00 €
- F025W3DA018 616,00 €
- F025W3DA030 616,00 €
- F025W3DA033 616,00 €

4000K

Non Dimmable

- F025W4DA001 616,00 €
- F025W4DA006 616,00 €
- F025W4DA012 616,00 €
- F025W4DA018 616,00 €
- F025W4DA030 616,00 €
- F025W4DA033 616,00 €

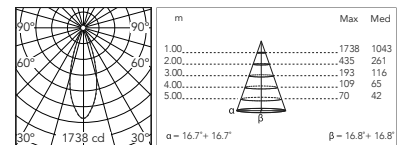

@ 3000K

Optic Wide Flood 50°

Power Led: 10,5W - 920 lm ≠ FIXT 591 lm - 2700K/CRI 80 - 220-240V / 10,5W - 966 lm ≠ FIXT 619 lm - 3000K/CRI 80 - 220-240V / 10,5W - 1012 lm ≠ FIXT 650 lm - 4000K/CRI 80 - 220-240V

2700K

Non Dimmable

- F025W2EA001 616,00 €
- F025W2EA006 616,00 €
- F025W2EA012 616,00 €
- F025W2EA018 616,00 €
- F025W2EA030 616,00 €
- F025W2EA033 616,00 €

3000K

Non Dimmable

- F025W3EA001 616,00 €
- F025W3EA006 616,00 €
- F025W3EA012 616,00 €
- F025W3EA018 616,00 €
- F025W3EA030 616,00 €
- F025W3EA033 616,00 €

4000K

Non Dimmable

- F025W4EA001 616,00 €
- F025W4EA006 616,00 €
- F025W4EA012 616,00 €
- F025W4EA018 616,00 €
- F025W4EA030 616,00 €
- F025W4EA033 616,00 €

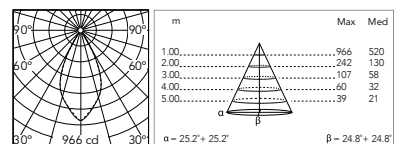

@ 3000K

Spine L 1 Pro Hp

Optic Elliptical 1 11,5° x 49°

Power Led: 10,5W - 920 lm ≠ FIXT 603 lm - 2700K/CRI 80 - 220-240V / 10,5W - 966 lm ≠ FIXT 639 lm - 3000K/CRI 80 - 220-240V / 10,5W - 1012 lm ≠ FIXT 663 lm - 4000K/CRI 80 - 220-240V

2700K

Non Dimmable

○ F025W2FA001	616,00 €
● F025W2FA006	616,00 €
● F025W2FA012	616,00 €
● F025W2FA018	616,00 €
● F025W2FA030	616,00 €
● F025W2FA033	616,00 €

3000K

Non Dimmable

○ F025W3FA001	616,00 €
● F025W3FA006	616,00 €
● F025W3FA012	616,00 €
● F025W3FA018	616,00 €
● F025W3FA030	616,00 €
● F025W3FA033	616,00 €

4000K

Non Dimmable

○ F025W4FA001	616,00 €
● F025W4FA006	616,00 €
● F025W4FA012	616,00 €
● F025W4FA018	616,00 €
● F025W4FA030	616,00 €
● F025W4FA033	616,00 €

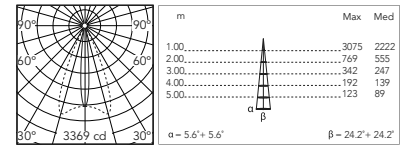

@ 3000K

Optic Elliptical 2 25,5° x 50°

Power Led: 10,5W - 920 lm ≠ FIXT 601 lm - 2700K/CRI 80 - 220-240V / 10,5W - 966 lm ≠ FIXT 624 lm - 3000K/CRI 80 - 220-240V / 10,5W - 1012 lm ≠ FIXT 645 lm - 4000K/CRI 80 - 220-240V

2700K

Non Dimmable

○ F025W2GA001	616,00 €
● F025W2GA006	616,00 €
● F025W2GA012	616,00 €
● F025W2GA018	616,00 €
● F025W2GA030	616,00 €
● F025W2GA033	616,00 €

3000K

Non Dimmable

○ F025W3GA001	616,00 €
● F025W3GA006	616,00 €
● F025W3GA012	616,00 €
● F025W3GA018	616,00 €
● F025W3GA030	616,00 €
● F025W3GA033	616,00 €

4000K

Non Dimmable

○ F025W4GA001	616,00 €
● F025W4GA006	616,00 €
● F025W4GA012	616,00 €
● F025W4GA018	616,00 €
● F025W4GA030	616,00 €
● F025W4GA033	616,00 €

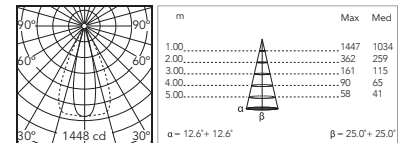

@ 3000K

Optic Wall Washer

Power Led: 10,5W - 920 lm ≠ FIXT 574 lm - 2700K/CRI 80 - 220-240V / 10,5W - 966 lm ≠ FIXT 609 lm - 3000K/CRI 80 - 220-240V / 10,5W - 1012 lm ≠ FIXT 631 lm - 4000K/CRI 80 - 220-240V

2700K

Non Dimmable

○ F025W2HA001	616,00 €
● F025W2HA006	616,00 €
● F025W2HA012	616,00 €
● F025W2HA018	616,00 €
● F025W2HA030	616,00 €
● F025W2HA033	616,00 €

3000K

Non Dimmable

○ F025W3HA001	616,00 €
● F025W3HA006	616,00 €
● F025W3HA012	616,00 €
● F025W3HA018	616,00 €
● F025W3HA030	616,00 €
● F025W3HA033	616,00 €

4000K

Non Dimmable

○ F025W4HA001	616,00 €
● F025W4HA006	616,00 €
● F025W4HA012	616,00 €
● F025W4HA018	616,00 €
● F025W4HA030	616,00 €
● F025W4HA033	616,00 €

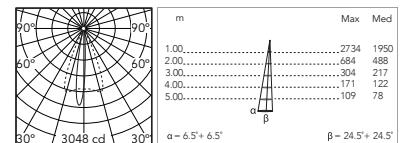

@ 3000K

Spine L 1 Pro: Accessoires / Accessories

Honeycomb	Honeycomb Louvre	F025Z060000	20,00 €		
Gelbox IPX8 pour le raccordement électrique.	Gelbox IPX8 for splicing connectors.	F990C100000	14,00 €		
Système de jonction IP68 H2O Stop anti-condensation à 2 voies 4 pôles.	2 way terminal block 4 poles IP68 H2O Stop.	F990C00A000	33,00 €		
Système de jonction IP68 H2O Stop anti-condensation à 3/4 voies 4 pôles. (Ø5,5÷12mm câble).	3/4 way terminal block 4 poles IP68 H2O Stop. (Ø5,5÷12mm cable).	F990C010000	60,00 €		
Lentilles de conversion / Converter lenses:					
- Converter Spine 0 / Spine 1 Optic Medium Flood		F029Z010000	35,00 €		
- Converter Spine 0 / Spine 1 Optic Flood		F029Z011000	35,00 €		
- Converter Spine 0 / Spine 1 Optic Wide Flood		F029Z012000	35,00 €		
- Converter Spine 0 / Spine 1 Optic Elliptic 1		F029Z013000	35,00 €		
- Converter Spine 0 / Spine 1 Optic Elliptic 2		F029Z014000	35,00 €		
- Converter Spine 0 / Spine 1 Optic Wall Washer		F029Z015000	35,00 €		

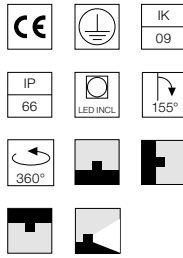
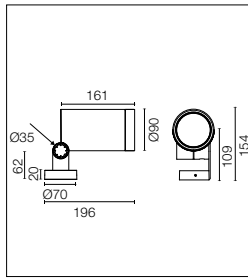

Source Power LED incluse. Équipée d'un snoot intégré pour un plus grand confort visuel. Les collimateurs sont des accessoires disponibles pour modifier la largeur du faisceau lumineux. Source d'alimentation électrique intégrée 220-240V ON/OFF et réglable 1-10V ou DALI. Support de montage minimum en L intégré. Équipée d'un câble en néoprène de 5m (10m sur commande) pour une connexion à distance; pour garantir l'étanchéité, il est conseillé d'utiliser des câbles flexibles conçus pour l'extérieur.

Power LED source included. Equipped with an integrated snoot for higher visual comfort. Collimators are available as an accessory to modify the beam opening. Integrated electric power supply 220-240V ON/OFF and adjustable 1-10V or DALI. Minimum L-shaped mounting support integrated. Equipped with a 5m neoprene cable (10m upon request) for remote connection. To guarantee its water tightness, it is recommended to use flexible cables designed for outdoor use.

Optic Narrow Spot
2200K disponible sur demande.

Optic Narrow Spot
2200K available on request.

Optic Narrow Spot 6°

Power Led: 4,1W - 248 lm ≠ FIXT 230 lm - 2700K/CRI 80 - 220-240V / 4,1W - 258 lm ≠ FIXT 239 lm - 3000K/CRI 80 - 220-240V / 4,1W - 267 lm ≠ FIXT 247 lm - 4000K/CRI 80 - 220-240V

2700K

Non Dimmable

○ F026V2AA001	720,00 €
● F026V2AA006	720,00 €
● F026V2AA012	720,00 €
● F026V2AA018	720,00 €
● F026V2AA030	720,00 €
● F026V2AA033	720,00 €
1-10V	
○ F026V2AB001	772,00 €
● F026V2AB006	772,00 €
● F026V2AB012	772,00 €
● F026V2AB018	772,00 €
● F026V2AB030	772,00 €
● F026V2AB033	772,00 €
Dali	
○ F026V2AD001	772,00 €
● F026V2AD006	772,00 €
● F026V2AD012	772,00 €
● F026V2AD018	772,00 €
● F026V2AD030	772,00 €
● F026V2AD033	772,00 €

3000K

Non Dimmable

○ F026V3AA001	720,00 €
● F026V3AA006	720,00 €
● F026V3AA012	720,00 €
● F026V3AA018	720,00 €
● F026V3AA030	720,00 €
● F026V3AA033	720,00 €
1-10V	
○ F026V3AB001	772,00 €
● F026V3AB006	772,00 €
● F026V3AB012	772,00 €
● F026V3AB018	772,00 €
● F026V3AB030	772,00 €
● F026V3AB033	772,00 €
Dali	
○ F026V3AD001	772,00 €
● F026V3AD006	772,00 €
● F026V3AD012	772,00 €
● F026V3AD018	772,00 €
● F026V3AD030	772,00 €
● F026V3AD033	772,00 €

4000K

Non Dimmable

○ F026V4AA001	720,00 €
● F026V4AA006	720,00 €
● F026V4AA012	720,00 €
● F026V4AA018	720,00 €
● F026V4AA030	720,00 €
● F026V4AA033	720,00 €
1-10V	
○ F026V4AB001	772,00 €
● F026V4AB006	772,00 €
● F026V4AB012	772,00 €
● F026V4AB018	772,00 €
● F026V4AB030	772,00 €
● F026V4AB033	772,00 €
Dali	
○ F026V4AD001	772,00 €
● F026V4AD006	772,00 €
● F026V4AD012	772,00 €
● F026V4AD018	772,00 €
● F026V4AD030	772,00 €
● F026V4AD033	772,00 €

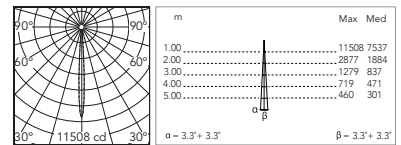

@ 3000K

Optic Spot 9,5°

Power Led: 10,5W - 920 lm ≠ FIXT 769 lm - 2700K/CRI 80 - 220-240V / 10,5W - 966 lm ≠ FIXT 808 lm - 3000K/CRI 80 - 220-240V / 10,5W - 1012 lm ≠ FIXT 846 lm - 4000K/CRI 80 - 220-240V

2700K

Non Dimmable

○ F026V2BA001	720,00 €
● F026V2BA006	720,00 €
● F026V2BA012	720,00 €
● F026V2BA018	720,00 €
● F026V2BA030	720,00 €
● F026V2BA033	720,00 €
1-10V	
○ F026V2BB001	772,00 €
● F026V2BB006	772,00 €
● F026V2BB012	772,00 €
● F026V2BB018	772,00 €
● F026V2BB030	772,00 €
● F026V2BB033	772,00 €
Dali	
○ F026V2BD001	772,00 €
● F026V2BD006	772,00 €
● F026V2BD012	772,00 €
● F026V2BD018	772,00 €
● F026V2BD030	772,00 €
● F026V2BD033	772,00 €

3000K

Non Dimmable

○ F026V3BA001	720,00 €
● F026V3BA006	720,00 €
● F026V3BA012	720,00 €
● F026V3BA018	720,00 €
● F026V3BA030	720,00 €
● F026V3BA033	720,00 €
1-10V	
○ F026V3BB001	772,00 €
● F026V3BB006	772,00 €
● F026V3BB012	772,00 €
● F026V3BB018	772,00 €
● F026V3BB030	772,00 €
● F026V3BB033	772,00 €
Dali	
○ F026V3BD001	772,00 €
● F026V3BD006	772,00 €
● F026V3BD012	772,00 €
● F026V3BD018	772,00 €
● F026V3BD030	772,00 €
● F026V3BD033	772,00 €

4000K

Non Dimmable

○ F026V4BA001	720,00 €
● F026V4BA006	720,00 €
● F026V4BA012	720,00 €
● F026V4BA018	720,00 €
● F026V4BA030	720,00 €
● F026V4BA033	720,00 €
1-10V	
○ F026V4BB001	772,00 €
● F026V4BB006	772,00 €
● F026V4BB012	772,00 €
● F026V4BB018	772,00 €
● F026V4BB030	772,00 €
● F026V4BB033	772,00 €
Dali	
○ F026V4BD001	772,00 €
● F026V4BD006	772,00 €
● F026V4BD012	772,00 €
● F026V4BD018	772,00 €
● F026V4BD030	772,00 €
● F026V4BD033	772,00 €

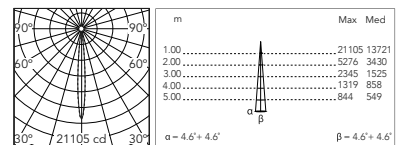

@ 3000K

Optic Medium Flood 28°

Power Led: 10,5W - 920 lm ≠ FIXT 715 lm - 2700K/CRI 80 - 220-240V / 10,5W - 966 lm ≠ FIXT 742 lm - 3000K/CRI 80 - 220-240V / 10,5W - 1012 lm ≠ FIXT 767 lm - 4000K/CRI 80 - 220-240V

2700K

Non Dimmable

- F026V2CA001 720,00 €
- F026V2CA006 720,00 €
- F026V2CA012 720,00 €
- F026V2CA018 720,00 €
- F026V2CA030 720,00 €
- F026V2CA033 720,00 €
- 1-10V
- F026V2CB001 772,00 €
- F026V2CB006 772,00 €
- F026V2CB012 772,00 €
- F026V2CB018 772,00 €
- F026V2CB030 772,00 €
- F026V2CB033 772,00 €
- Dali
- F026V2CD001 772,00 €
- F026V2CD006 772,00 €
- F026V2CD012 772,00 €
- F026V2CD018 772,00 €
- F026V2CD030 772,00 €
- F026V2CD033 772,00 €

3000K

Non Dimmable

- F026V3CA001 720,00 €
- F026V3CA006 720,00 €
- F026V3CA012 720,00 €
- F026V3CA018 720,00 €
- F026V3CA030 720,00 €
- F026V3CA033 720,00 €
- 1-10V
- F026V3CB001 772,00 €
- F026V3CB006 772,00 €
- F026V3CB012 772,00 €
- F026V3CB018 772,00 €
- F026V3CB030 772,00 €
- F026V3CB033 772,00 €
- Dali
- F026V3CD001 772,00 €
- F026V3CD006 772,00 €
- F026V3CD012 772,00 €
- F026V3CD018 772,00 €
- F026V3CD030 772,00 €
- F026V3CD033 772,00 €

4000K

Non Dimmable

- F026V4CA001 720,00 €
- F026V4CA006 720,00 €
- F026V4CA012 720,00 €
- F026V4CA018 720,00 €
- F026V4CA030 720,00 €
- F026V4CA033 720,00 €
- 1-10V
- F026V4CB001 772,00 €
- F026V4CB006 772,00 €
- F026V4CB012 772,00 €
- F026V4CB018 772,00 €
- F026V4CB030 772,00 €
- F026V4CB033 772,00 €
- Dali
- F026V4CD001 772,00 €
- F026V4CD006 772,00 €
- F026V4CD012 772,00 €
- F026V4CD018 772,00 €
- F026V4CD030 772,00 €
- F026V4CD033 772,00 €

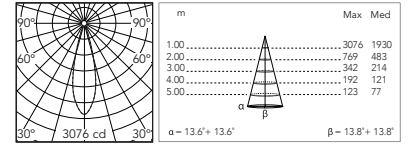

@ 3000K

Optic Flood 33°

Power Led: 10,5W - 920 lm ≠ FIXT 695 lm - 2700K/CRI 80 - 220-240V / 10,5W - 966 lm ≠ FIXT 721 lm - 3000K/CRI 80 - 220-240V / 10,5W - 1012 lm ≠ FIXT 746 lm - 4000K/CRI 80 - 220-240V

2700K

Non Dimmable

- F026V2DA001 720,00 €
- F026V2DA006 720,00 €
- F026V2DA012 720,00 €
- F026V2DA018 720,00 €
- F026V2DA030 720,00 €
- F026V2DA033 720,00 €
- 1-10V
- F026V2DB001 772,00 €
- F026V2DB006 772,00 €
- F026V2DB012 772,00 €
- F026V2DB018 772,00 €
- F026V2DB030 772,00 €
- F026V2DB033 772,00 €
- Dali
- F026V2DD001 772,00 €
- F026V2DD006 772,00 €
- F026V2DD012 772,00 €
- F026V2DD018 772,00 €
- F026V2DD030 772,00 €
- F026V2DD033 772,00 €

3000K

Non Dimmable

- F026V3DA001 720,00 €
- F026V3DA006 720,00 €
- F026V3DA012 720,00 €
- F026V3DA018 720,00 €
- F026V3DA030 720,00 €
- F026V3DA033 720,00 €
- 1-10V
- F026V3DB001 772,00 €
- F026V3DB006 772,00 €
- F026V3DB012 772,00 €
- F026V3DB018 772,00 €
- F026V3DB030 772,00 €
- F026V3DB033 772,00 €
- Dali
- F026V3DD001 772,00 €
- F026V3DD006 772,00 €
- F026V3DD012 772,00 €
- F026V3DD018 772,00 €
- F026V3DD030 772,00 €
- F026V3DD033 772,00 €

4000K

Non Dimmable

- F026V4DA001 720,00 €
- F026V4DA006 720,00 €
- F026V4DA012 720,00 €
- F026V4DA018 720,00 €
- F026V4DA030 720,00 €
- F026V4DA033 720,00 €
- 1-10V
- F026V4DB001 772,00 €
- F026V4DB006 772,00 €
- F026V4DB012 772,00 €
- F026V4DB018 772,00 €
- F026V4DB030 772,00 €
- F026V4DB033 772,00 €
- Dali
- F026V4DD001 772,00 €
- F026V4DD006 772,00 €
- F026V4DD012 772,00 €
- F026V4DD018 772,00 €
- F026V4DD030 772,00 €
- F026V4DD033 772,00 €

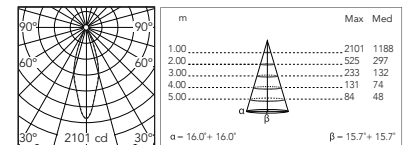

@ 3000K

Optic Wide Flood 51°

Power Led: 10,5W - 920 lm ≠ FIXT 711 lm - 2700K/CRI 80 - 220-240V / 10,5W - 966 lm ≠ FIXT 741 lm - 3000K/CRI 80 - 220-240V / 10,5W - 1012 lm ≠ FIXT 778 lm - 4000K/CRI 80 - 220-240V

2700K

Non Dimmable

- F026V2EA001 720,00 €
- F026V2EA006 720,00 €
- F026V2EA012 720,00 €
- F026V2EA018 720,00 €
- F026V2EA030 720,00 €
- F026V2EA033 720,00 €
- 1-10V
- F026V2EB001 772,00 €
- F026V2EB006 772,00 €
- F026V2EB012 772,00 €
- F026V2EB018 772,00 €
- F026V2EB030 772,00 €
- F026V2EB033 772,00 €
- Dali
- F026V2ED001 772,00 €
- F026V2ED006 772,00 €
- F026V2ED012 772,00 €
- F026V2ED018 772,00 €
- F026V2ED030 772,00 €
- F026V2ED033 772,00 €

3000K

Non Dimmable

- F026V3EA001 720,00 €
- F026V3EA006 720,00 €
- F026V3EA012 720,00 €
- F026V3EA018 720,00 €
- F026V3EA030 720,00 €
- F026V3EA033 720,00 €
- 1-10V
- F026V3EB001 772,00 €
- F026V3EB006 772,00 €
- F026V3EB012 772,00 €
- F026V3EB018 772,00 €
- F026V3EB030 772,00 €
- F026V3EB033 772,00 €
- Dali
- F026V3ED001 772,00 €
- F026V3ED006 772,00 €
- F026V3ED012 772,00 €
- F026V3ED018 772,00 €
- F026V3ED030 772,00 €
- F026V3ED033 772,00 €

4000K

Non Dimmable

- F026V4EA001 720,00 €
- F026V4EA006 720,00 €
- F026V4EA012 720,00 €
- F026V4EA018 720,00 €
- F026V4EA030 720,00 €
- F026V4EA033 720,00 €
- 1-10V
- F026V4EB001 772,00 €
- F026V4EB006 772,00 €
- F026V4EB012 772,00 €
- F026V4EB018 772,00 €
- F026V4EB030 772,00 €
- F026V4EB033 772,00 €
- Dali
- F026V4ED001 772,00 €
- F026V4ED006 772,00 €
- F026V4ED012 772,00 €
- F026V4ED018 772,00 €
- F026V4ED030 772,00 €
- F026V4ED033 772,00 €

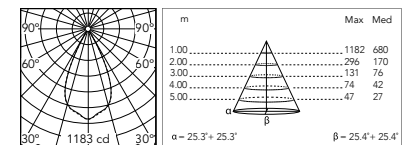

@ 3000K

Spine L 2 Pro

Optic Elliptical 1 9,5° x 48°

Power Led: 10,5W - 920 lm ≠ FIXT 717 lm - 2700K/CRI 80 - 220-240V / 10,5W - 966 lm ≠ FIXT 744 lm - 3000K/CRI 80 - 220-240V / 10,5W - 1012 lm ≠ FIXT 770 lm - 4000K/CRI 80 - 220-240V

2700K		3000K		4000K	
Non Dimmable		Non Dimmable		Non Dimmable	
○ F026V2FA001	720,00 €	○ F026V3FA001	720,00 €	○ F026V4FA001	720,00 €
● F026V2FA006	720,00 €	● F026V3FA006	720,00 €	● F026V4FA006	720,00 €
● F026V2FA012	720,00 €	● F026V3FA012	720,00 €	● F026V4FA012	720,00 €
● F026V2FA018	720,00 €	● F026V3FA018	720,00 €	● F026V4FA018	720,00 €
● F026V2FA030	720,00 €	● F026V3FA030	720,00 €	● F026V4FA030	720,00 €
● F026V2FA033	720,00 €	● F026V3FA033	720,00 €	● F026V4FA033	720,00 €
1-10V					
○ F026V2FB001	772,00 €	○ F026V3FB001	772,00 €	○ F026V4FB001	772,00 €
● F026V2FB006	772,00 €	● F026V3FB006	772,00 €	● F026V4FB006	772,00 €
● F026V2FB012	772,00 €	● F026V3FB012	772,00 €	● F026V4FB012	772,00 €
● F026V2FB018	772,00 €	● F026V3FB018	772,00 €	● F026V4FB018	772,00 €
● F026V2FB030	772,00 €	● F026V3FB030	772,00 €	● F026V4FB030	772,00 €
● F026V2FB033	772,00 €	● F026V3FB033	772,00 €	● F026V4FB033	772,00 €
Dali					
○ F026V2FD001	772,00 €	○ F026V3FD001	772,00 €	○ F026V4FD001	772,00 €
● F026V2FD006	772,00 €	● F026V3FD006	772,00 €	● F026V4FD006	772,00 €
● F026V2FD012	772,00 €	● F026V3FD012	772,00 €	● F026V4FD012	772,00 €
● F026V2FD018	772,00 €	● F026V3FD018	772,00 €	● F026V4FD018	772,00 €
● F026V2FD030	772,00 €	● F026V3FD030	772,00 €	● F026V4FD030	772,00 €
● F026V2FD033	772,00 €	● F026V3FD033	772,00 €	● F026V4FD033	772,00 €

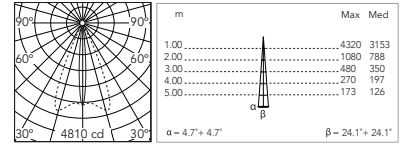

@ 3000K

Optic Elliptical 2 24° x 50°

Power Led: 10,5W - 920 lm ≠ FIXT 699 lm - 2700K/CRI 80 - 220-240V / 10,5W - 966 lm ≠ FIXT 725 lm - 3000K/CRI 80 - 220-240V / 10,5W - 1012 lm ≠ FIXT 750 lm - 4000K/CRI 80 - 220-240V

2700K		3000K		4000K	
Non Dimmable		Non Dimmable		Non Dimmable	
○ F026V2GA001	720,00 €	○ F026V3GA001	720,00 €	○ F026V4GA001	720,00 €
● F026V2GA006	720,00 €	● F026V3GA006	720,00 €	● F026V4GA006	720,00 €
● F026V2GA012	720,00 €	● F026V3GA012	720,00 €	● F026V4GA012	720,00 €
● F026V2GA018	720,00 €	● F026V3GA018	720,00 €	● F026V4GA018	720,00 €
● F026V2GA030	720,00 €	● F026V3GA030	720,00 €	● F026V4GA030	720,00 €
● F026V2GA033	720,00 €	● F026V3GA033	720,00 €	● F026V4GA033	720,00 €
1-10V					
○ F026V2GB001	772,00 €	○ F026V3GB001	772,00 €	○ F026V4GB001	772,00 €
● F026V2GB006	772,00 €	● F026V3GB006	772,00 €	● F026V4GB006	772,00 €
● F026V2GB012	772,00 €	● F026V3GB012	772,00 €	● F026V4GB012	772,00 €
● F026V2GB018	772,00 €	● F026V3GB018	772,00 €	● F026V4GB018	772,00 €
● F026V2GB030	772,00 €	● F026V3GB030	772,00 €	● F026V4GB030	772,00 €
● F026V2GB033	772,00 €	● F026V3GB033	772,00 €	● F026V4GB033	772,00 €
Dali					
○ F026V2GD001	772,00 €	○ F026V3GD001	772,00 €	○ F026V4GD001	772,00 €
● F026V2GD006	772,00 €	● F026V3GD006	772,00 €	● F026V4GD006	772,00 €
● F026V2GD012	772,00 €	● F026V3GD012	772,00 €	● F026V4GD012	772,00 €
● F026V2GD018	772,00 €	● F026V3GD018	772,00 €	● F026V4GD018	772,00 €
● F026V2GD030	772,00 €	● F026V3GD030	772,00 €	● F026V4GD030	772,00 €
● F026V2GD033	772,00 €	● F026V3GD033	772,00 €	● F026V4GD033	772,00 €

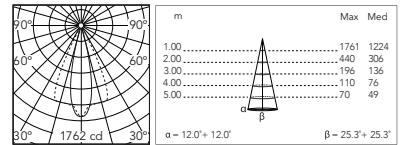

@ 3000K

Optic Wall Washer

Power Led: 10,5W - 920 lm ≠ FIXT 673 lm - 2700K/CRI 80 - 220-240V / 10,5W - 966 lm ≠ FIXT 698 lm - 3000K/CRI 80 - 220-240V / 10,5W - 1012 lm ≠ FIXT 672 lm - 4000K/CRI 80 - 220-240V

2700K		3000K		4000K	
Non Dimmable		Non Dimmable		Non Dimmable	
○ F026V2HA001	720,00 €	○ F026V3HA001	720,00 €	○ F026V4HA001	720,00 €
● F026V2HA006	720,00 €	● F026V3HA006	720,00 €	● F026V4HA006	720,00 €
● F026V2HA012	720,00 €	● F026V3HA012	720,00 €	● F026V4HA012	720,00 €
● F026V2HA018	720,00 €	● F026V3HA018	720,00 €	● F026V4HA018	720,00 €
● F026V2HA030	720,00 €	● F026V3HA030	720,00 €	● F026V4HA030	720,00 €
● F026V2HA033	720,00 €	● F026V3HA033	720,00 €	● F026V4HA033	720,00 €
1-10V					
○ F026V2HB001	772,00 €	○ F026V3HB001	772,00 €	○ F026V4HB001	772,00 €
● F026V2HB006	772,00 €	● F026V3HB006	772,00 €	● F026V4HB006	772,00 €
● F026V2HB012	772,00 €	● F026V3HB012	772,00 €	● F026V4HB012	772,00 €
● F026V2HB018	772,00 €	● F026V3HB018	772,00 €	● F026V4HB018	772,00 €
● F026V2HB030	772,00 €	● F026V3HB030	772,00 €	● F026V4HB030	772,00 €
● F026V2HB033	772,00 €	● F026V3HB033	772,00 €	● F026V4HB033	772,00 €
Dali					
○ F026V2HD001	772,00 €	○ F026V3HD001	772,00 €	○ F026V4HD001	772,00 €
● F026V2HD006	772,00 €	● F026V3HD006	772,00 €	● F026V4HD006	772,00 €
● F026V2HD012	772,00 €	● F026V3HD012	772,00 €	● F026V4HD012	772,00 €
● F026V2HD018	772,00 €	● F026V3HD018	772,00 €	● F026V4HD018	772,00 €
● F026V2HD030	772,00 €	● F026V3HD030	772,00 €	● F026V4HD030	772,00 €
● F026V2HD033	772,00 €	● F026V3HD033	772,00 €	● F026V4HD033	772,00 €

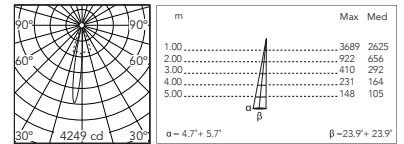

@ 3000K

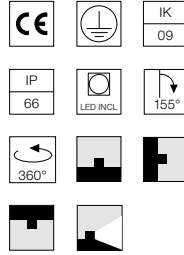
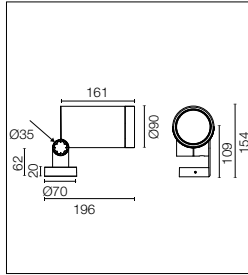

Source LED à basse consommation incluse. Équipée d'un snoot intégré pour un plus grand confort visuel. Les collimateurs sont des accessoires disponibles pour modifier la largeur du faisceau lumineux. Source d'alimentation électrique intégrée 220-240V ON/OFF et réglable 1-10V ou DALI. Support de montage minimum en L intégré. Équipée d'un câble en néoprène de 5m (10m sur commande) pour une connexion à distance; pour garantir l'étanchéité, il est conseillé d'utiliser des câbles flexibles conçus pour l'extérieur.

Energy-efficient Power LED source included Equipped with an integrated snoot for higher visual comfort. Collimators are available as an accessory to modify the beam opening. Integrated electric power supply 220-240V ON/OFF and adjustable 1-10V or DALI. Minimum L-shaped mounting support integrated. Equipped with a 5m neoprene cable (10m upon request) for remote connection. To guarantee its water tightness, it is recommended to use flexible cables designed for outdoor use.

2200K disponible sur demande.

2200K available on request.

Optic Spot 14,5°

Power Led: 17W - 1739 lm ≠ FIXT 1443 lm - 2700K/CRI 80 - 220-240V / 17W - 1803 lm ≠ FIXT 1497 lm - 3000K/CRI 80 - 220-240V / 17W - 1868 lm ≠ FIXT 1548 lm - 4000K/CRI 80 - 220-240V

2700K

Non Dimmable

- F026W2BA001 720,00 €
- F026W2BA006 720,00 €
- F026W2BA012 720,00 €
- F026W2BA018 720,00 €
- F026W2BA030 720,00 €
- F026W2BA033 720,00 €
- 1-10V
- F026W2BB001 772,00 €
- F026W2BB006 772,00 €
- F026W2BB012 772,00 €
- F026W2BB018 772,00 €
- F026W2BB030 772,00 €
- F026W2BB033 772,00 €
- Dali
- F026W2BD001 772,00 €
- F026W2BD006 772,00 €
- F026W2BD012 772,00 €
- F026W2BD018 772,00 €
- F026W2BD030 772,00 €
- F026W2BD033 772,00 €

3000K

Non Dimmable

- F026W3BA001 720,00 €
- F026W3BA006 720,00 €
- F026W3BA012 720,00 €
- F026W3BA018 720,00 €
- F026W3BA030 720,00 €
- F026W3BA033 720,00 €
- 1-10V
- F026W3BB001 772,00 €
- F026W3BB006 772,00 €
- F026W3BB012 772,00 €
- F026W3BB018 772,00 €
- F026W3BB030 772,00 €
- F026W3BB033 772,00 €
- Dali
- F026W3BD001 772,00 €
- F026W3BD006 772,00 €
- F026W3BD012 772,00 €
- F026W3BD018 772,00 €
- F026W3BD030 772,00 €
- F026W3BD033 772,00 €

4000K

Non Dimmable

- F026W4BA001 720,00 €
- F026W4BA006 720,00 €
- F026W4BA012 720,00 €
- F026W4BA018 720,00 €
- F026W4BA030 720,00 €
- F026W4BA033 720,00 €
- 1-10V
- F026W4BB001 772,00 €
- F026W4BB006 772,00 €
- F026W4BB012 772,00 €
- F026W4BB018 772,00 €
- F026W4BB030 772,00 €
- F026W4BB033 772,00 €
- Dali
- F026W4BD001 772,00 €
- F026W4BD006 772,00 €
- F026W4BD012 772,00 €
- F026W4BD018 772,00 €
- F026W4BD030 772,00 €
- F026W4BD033 772,00 €

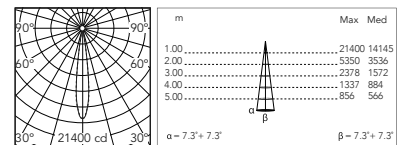

@ 3000K

Optic Medium Flood 26°

Power Led: 17W - 1739 lm ≠ FIXT 1336 lm - 2700K/CRI 80 - 220-240V / 17W - 1803 lm ≠ FIXT 1386 lm - 3000K/CRI 80 - 220-240V / 17W - 1868 lm ≠ FIXT 1434 lm - 4000K/CRI 80 - 220-240V

2700K

Non Dimmable

- F026W2CA001 720,00 €
- F026W2CA006 720,00 €
- F026W2CA012 720,00 €
- F026W2CA018 720,00 €
- F026W2CA030 720,00 €
- F026W2CA033 720,00 €
- 1-10V
- F026W2CB001 772,00 €
- F026W2CB006 772,00 €
- F026W2CB012 772,00 €
- F026W2CB018 772,00 €
- F026W2CB030 772,00 €
- F026W2CB033 772,00 €
- Dali
- F026W2CD001 772,00 €
- F026W2CD006 772,00 €
- F026W2CD012 772,00 €
- F026W2CD018 772,00 €
- F026W2CD030 772,00 €
- F026W2CD033 772,00 €

3000K

Non Dimmable

- F026W3CA001 720,00 €
- F026W3CA006 720,00 €
- F026W3CA012 720,00 €
- F026W3CA018 720,00 €
- F026W3CA030 720,00 €
- F026W3CA033 720,00 €
- 1-10V
- F026W3CB001 772,00 €
- F026W3CB006 772,00 €
- F026W3CB012 772,00 €
- F026W3CB018 772,00 €
- F026W3CB030 772,00 €
- F026W3CB033 772,00 €
- Dali
- F026W3CD001 772,00 €
- F026W3CD006 772,00 €
- F026W3CD012 772,00 €
- F026W3CD018 772,00 €
- F026W3CD030 772,00 €
- F026W3CD033 772,00 €

4000K

Non Dimmable

- F026W4CA001 720,00 €
- F026W4CA006 720,00 €
- F026W4CA012 720,00 €
- F026W4CA018 720,00 €
- F026W4CA030 720,00 €
- F026W4CA033 720,00 €
- 1-10V
- F026W4CB001 772,00 €
- F026W4CB006 772,00 €
- F026W4CB012 772,00 €
- F026W4CB018 772,00 €
- F026W4CB030 772,00 €
- F026W4CB033 772,00 €
- Dali
- F026W4CD001 772,00 €
- F026W4CD006 772,00 €
- F026W4CD012 772,00 €
- F026W4CD018 772,00 €
- F026W4CD030 772,00 €
- F026W4CD033 772,00 €

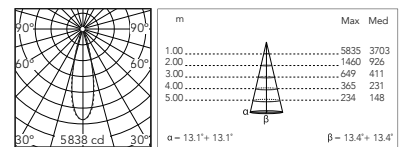

@ 3000K

Spine L 2 Pro Hp

Optic Flood 36°

Power Led: 17W - 1739 lm ≠ FIXT 1302 lm - 2700K/CRI 80 - 220-240V / 17W - 1803 lm ≠ FIXT 1351 lm - 3000K/CRI 80 - 220-240V / 17W - 1868 lm ≠ FIXT 1397 lm - 4000K/CRI 80 - 220-240V

2700K		3000K		4000K	
Non Dimmable		Non Dimmable		Non Dimmable	
○ F026W2DA001	720,00 €	○ F026W3DA001	720,00 €	○ F026W4DA001	720,00 €
● F026W2DA006	720,00 €	● F026W3DA006	720,00 €	● F026W4DA006	720,00 €
● F026W2DA012	720,00 €	● F026W3DA012	720,00 €	● F026W4DA012	720,00 €
● F026W2DA018	720,00 €	● F026W3DA018	720,00 €	● F026W4DA018	720,00 €
● F026W2DA030	720,00 €	● F026W3DA030	720,00 €	● F026W4DA030	720,00 €
● F026W2DA033	720,00 €	● F026W3DA033	720,00 €	● F026W4DA033	720,00 €
1-10V					
○ F026W2DB001	772,00 €	○ F026W3DB001	772,00 €	○ F026W4DB001	772,00 €
○ F026W2DB006	772,00 €	○ F026W3DB006	772,00 €	○ F026W4DB006	772,00 €
● F026W2DB012	772,00 €	● F026W3DB012	772,00 €	● F026W4DB012	772,00 €
● F026W2DB018	772,00 €	● F026W3DB018	772,00 €	● F026W4DB018	772,00 €
● F026W2DB030	772,00 €	● F026W3DB030	772,00 €	● F026W4DB030	772,00 €
● F026W2DB033	772,00 €	● F026W3DB033	772,00 €	● F026W4DB033	772,00 €
Dali					
○ F026W2DD001	772,00 €	○ F026W3DD001	772,00 €	○ F026W4DD001	772,00 €
○ F026W2DD006	772,00 €	○ F026W3DD006	772,00 €	○ F026W4DD006	772,00 €
● F026W2DD012	772,00 €	● F026W3DD012	772,00 €	● F026W4DD012	772,00 €
● F026W2DD018	772,00 €	● F026W3DD018	772,00 €	● F026W4DD018	772,00 €
● F026W2DD030	772,00 €	● F026W3DD030	772,00 €	● F026W4DD030	772,00 €
● F026W2DD033	772,00 €	● F026W3DD033	772,00 €	● F026W4DD033	772,00 €

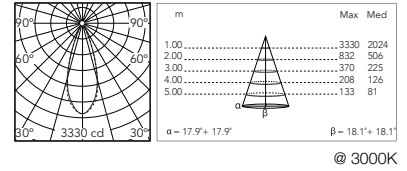

Optic Wide Flood 52°

Power Led: 17W - 1739 lm ≠ FIXT 1303 lm - 2700K/CRI 80 - 220-240V / 17W - 1803 lm ≠ FIXT 1357 lm - 3000K/CRI 80 - 220-240V / 17W - 1868 lm ≠ FIXT 1411 lm - 4000K/CRI 80 - 220-240V

2700K		3000K		4000K	
Non Dimmable		Non Dimmable		Non Dimmable	
○ F026W2EA001	720,00 €	○ F026W3EA001	720,00 €	○ F026W4EA001	720,00 €
○ F026W2EA006	720,00 €	○ F026W3EA006	720,00 €	○ F026W4EA006	720,00 €
● F026W2EA012	720,00 €	● F026W3EA012	720,00 €	● F026W4EA012	720,00 €
● F026W2EA018	720,00 €	● F026W3EA018	720,00 €	● F026W4EA018	720,00 €
● F026W2EA030	720,00 €	● F026W3EA030	720,00 €	● F026W4EA030	720,00 €
● F026W2EA033	720,00 €	● F026W3EA033	720,00 €	● F026W4EA033	720,00 €
1-10V					
○ F026W2EB001	772,00 €	○ F026W3EB001	772,00 €	○ F026W4EB001	772,00 €
○ F026W2EB006	772,00 €	○ F026W3EB006	772,00 €	○ F026W4EB006	772,00 €
● F026W2EB012	772,00 €	● F026W3EB012	772,00 €	● F026W4EB012	772,00 €
● F026W2EB018	772,00 €	● F026W3EB018	772,00 €	● F026W4EB018	772,00 €
● F026W2EB030	772,00 €	● F026W3EB030	772,00 €	● F026W4EB030	772,00 €
● F026W2EB033	772,00 €	● F026W3EB033	772,00 €	● F026W4EB033	772,00 €
Dali					
○ F026W2ED001	772,00 €	○ F026W3ED001	772,00 €	○ F026W4ED001	772,00 €
○ F026W2ED006	772,00 €	○ F026W3ED006	772,00 €	○ F026W4ED006	772,00 €
● F026W2ED012	772,00 €	● F026W3ED012	772,00 €	● F026W4ED012	772,00 €
● F026W2ED018	772,00 €	● F026W3ED018	772,00 €	● F026W4ED018	772,00 €
● F026W2ED030	772,00 €	● F026W3ED030	772,00 €	● F026W4ED030	772,00 €
● F026W2ED033	772,00 €	● F026W3ED033	772,00 €	● F026W4ED033	772,00 €

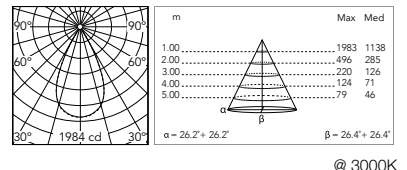

Optic Elliptical 1 14° x 50°

Power Led: 17W - 1739 lm ≠ FIXT 1315 lm - 2700K/CRI 80 - 220-240V / 17W - 1803 lm ≠ FIXT 1364 lm - 3000K/CRI 80 - 220-240V / 17W - 1868 lm ≠ FIXT 1410 lm - 4000K/CRI 80 - 220-240V

2700K		3000K		4000K	
Non Dimmable		Non Dimmable		Non Dimmable	
○ F026W2FA001	720,00 €	○ F026W3FA001	720,00 €	○ F026W4FA001	720,00 €
○ F026W2FA006	720,00 €	○ F026W3FA006	720,00 €	○ F026W4FA006	720,00 €
● F026W2FA012	720,00 €	● F026W3FA012	720,00 €	● F026W4FA012	720,00 €
● F026W2FA018	720,00 €	● F026W3FA018	720,00 €	● F026W4FA018	720,00 €
● F026W2FA030	720,00 €	● F026W3FA030	720,00 €	● F026W4FA030	720,00 €
● F026W2FA033	720,00 €	● F026W3FA033	720,00 €	● F026W4FA033	720,00 €
1-10V					
○ F026W2FB001	772,00 €	○ F026W3FB001	772,00 €	○ F026W4FB001	772,00 €
○ F026W2FB006	772,00 €	○ F026W3FB006	772,00 €	○ F026W4FB006	772,00 €
● F026W2FB012	772,00 €	● F026W3FB012	772,00 €	● F026W4FB012	772,00 €
● F026W2FB018	772,00 €	● F026W3FB018	772,00 €	● F026W4FB018	772,00 €
● F026W2FB030	772,00 €	● F026W3FB030	772,00 €	● F026W4FB030	772,00 €
● F026W2FB033	772,00 €	● F026W3FB033	772,00 €	● F026W4FB033	772,00 €
Dali					
○ F026W2FD001	772,00 €	○ F026W3FD001	772,00 €	○ F026W4FD001	772,00 €
○ F026W2FD006	772,00 €	○ F026W3FD006	772,00 €	○ F026W4FD006	772,00 €
● F026W2FD012	772,00 €	● F026W3FD012	772,00 €	● F026W4FD012	772,00 €
● F026W2FD018	772,00 €	● F026W3FD018	772,00 €	● F026W4FD018	772,00 €
● F026W2FD030	772,00 €	● F026W3FD030	772,00 €	● F026W4FD030	772,00 €
● F026W2FD033	772,00 €	● F026W3FD033	772,00 €	● F026W4FD033	772,00 €

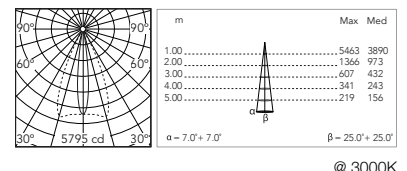

Optic Elliptical 2 25° x 52°

Power Led: 17W - 1739 lm ≠ FIXT 1298 lm - 2700K/CRI 80 - 220-240V / 17W - 1803 lm ≠ FIXT 1351 lm - 3000K/CRI 80 - 220-240V / 17W - 1868 lm ≠ FIXT 1393 lm - 4000K/CRI 80 - 220-240V

2700K

Non Dimmable

- F026W2GA001 720,00 €
- F026W2GA006 720,00 €
- F026W2GA012 720,00 €
- F026W2GA018 720,00 €
- F026W2GA030 720,00 €
- F026W2GA033 720,00 €

1-10V

- F026W2GB001 772,00 €
- F026W2GB006 772,00 €
- F026W2GB012 772,00 €
- F026W2GB018 772,00 €
- F026W2GB030 772,00 €
- F026W2GB033 772,00 €

Dali

- F026W2GD001 772,00 €
- F026W2GD006 772,00 €
- F026W2GD012 772,00 €
- F026W2GD018 772,00 €
- F026W2GD030 772,00 €
- F026W2GD033 772,00 €

3000K

Non Dimmable

- F026W3GA001 720,00 €
- F026W3GA006 720,00 €
- F026W3GA012 720,00 €
- F026W3GA018 720,00 €
- F026W3GA030 720,00 €
- F026W3GA033 720,00 €

1-10V

- F026W3GB001 772,00 €
- F026W3GB006 772,00 €
- F026W3GB012 772,00 €
- F026W3GB018 772,00 €
- F026W3GB030 772,00 €
- F026W3GB033 772,00 €

Dali

- F026W3GD001 772,00 €
- F026W3GD006 772,00 €
- F026W3GD012 772,00 €
- F026W3GD018 772,00 €
- F026W3GD030 772,00 €
- F026W3GD033 772,00 €

4000K

Non Dimmable

- F026W4GA001 720,00 €
- F026W4GA006 720,00 €
- F026W4GA012 720,00 €
- F026W4GA018 720,00 €
- F026W4GA030 720,00 €
- F026W4GA033 720,00 €

1-10V

- F026W4GB001 772,00 €
- F026W4GB006 772,00 €
- F026W4GB012 772,00 €
- F026W4GB018 772,00 €
- F026W4GB030 772,00 €
- F026W4GB033 772,00 €

Dali

- F026W4GD001 772,00 €
- F026W4GD006 772,00 €
- F026W4GD012 772,00 €
- F026W4GD018 772,00 €
- F026W4GD030 772,00 €
- F026W4GD033 772,00 €

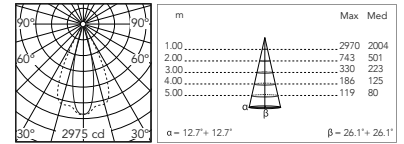

@ 3000K

Optic Wall Washer

Power Led: 17W - 1739 lm ≠ FIXT 1277 lm - 2700K/CRI 80 - 220-240V / 17W - 1803 lm ≠ FIXT 1325 lm - 3000K/CRI 80 - 220-240V / 17W - 1868 lm ≠ FIXT 1370 lm - 4000K/CRI 80 - 220-240V

2700K

Non Dimmable

- F026W2HA001 720,00 €
- F026W2HA006 720,00 €
- F026W2HA012 720,00 €
- F026W2HA018 720,00 €
- F026W2HA030 720,00 €
- F026W2HA033 720,00 €

1-10V

- F026W2HB001 772,00 €
- F026W2HB006 772,00 €
- F026W2HB012 772,00 €
- F026W2HB018 772,00 €
- F026W2HB030 772,00 €
- F026W2HB033 772,00 €

Dali

- F026W2HD001 772,00 €
- F026W2HD006 772,00 €
- F026W2HD012 772,00 €
- F026W2HD018 772,00 €
- F026W2HD030 772,00 €
- F026W2HD033 772,00 €

3000K

Non Dimmable

- F026W3HA001 720,00 €
- F026W3HA006 720,00 €
- F026W3HA012 720,00 €
- F026W3HA018 720,00 €
- F026W3HA030 720,00 €
- F026W3HA033 720,00 €

1-10V

- F026W3HB001 772,00 €
- F026W3HB006 772,00 €
- F026W3HB012 772,00 €
- F026W3HB018 772,00 €
- F026W3HB030 772,00 €
- F026W3HB033 772,00 €

Dali

- F026W3HD001 772,00 €
- F026W3HD006 772,00 €
- F026W3HD012 772,00 €
- F026W3HD018 772,00 €
- F026W3HD030 772,00 €
- F026W3HD033 772,00 €

4000K

Non Dimmable

- F026W4HA001 720,00 €
- F026W4HA006 720,00 €
- F026W4HA012 720,00 €
- F026W4HA018 720,00 €
- F026W4HA030 720,00 €
- F026W4HA033 720,00 €

1-10V

- F026W4HB001 772,00 €
- F026W4HB006 772,00 €
- F026W4HB012 772,00 €
- F026W4HB018 772,00 €
- F026W4HB030 772,00 €
- F026W4HB033 772,00 €





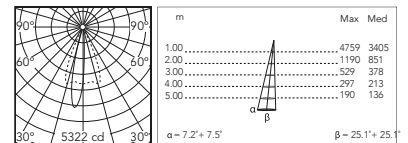





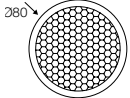

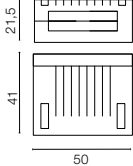
Dali

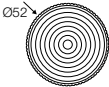
- F026W4HD001 772,00 €
- F026W4HD006 772,00 €
- F026W4HD012 772,00 €
- F026W4HD018 772,00 €
- F026W4HD030 772,00 €
- F026W4HD033 772,00 €

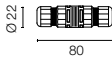

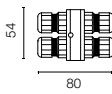
@ 3000K

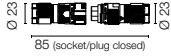
Spine L 2 Pro: Accessoires / Accessories

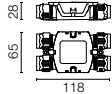
Honeycomb	Honeycomb Louvre	F026Z060000	21,00 €		
Gelbox IPX8 pour le raccordement électrique.	Gelbox IPX8 for splicing connectors.	F990C110000	22,00 €		
Lentilles de conversion / Converter lenses:					
- Converter Spine 2 Optic Medium Flood		F029Z020000	37,00 €		
- Converter Spine 2 Optic Flood		F029Z021000	37,00 €		
- Converter Spine 2 Optic Wide Flood		F029Z022000	37,00 €		
- Converter Spine 2 Optic Elliptic 1		F029Z023000	37,00 €		
- Converter Spine 2 Optic Elliptic 2		F029Z024000	37,00 €		
- Converter Spine 2 Optic Wall Washer		F029Z025000	37,00 €		
Système de jonction IP68 H2O Stop anti-condensation à 2 voies 4 pôles.	2 way terminal block 4 poles IP68 H2O Stop.	F990C00A000	33,00 €		
Système de jonction IP68 H2O Stop anti-condensation à 3/4 voies 4 pôles. (Ø5,5÷12mm câble). (Ø5,5÷12mm câble).	3/4 way terminal block 4 poles IP68 H2O Stop. (Ø5,5÷12mm câble).	F990C010000	60,00 €		
Kit de connecteurs à 5 pôles: fiche volante + fiche EU IP68.	Connector kit 5-pole flying socket + EU plug IP68.	F990C080000	48,00 €		
Boitier de dérivation 5 pôles 4 voies (câbles 6-14 mm).	4 way junction box 5 poles IP68 (6-14 mm cables).	F990C030000	62,00 €		

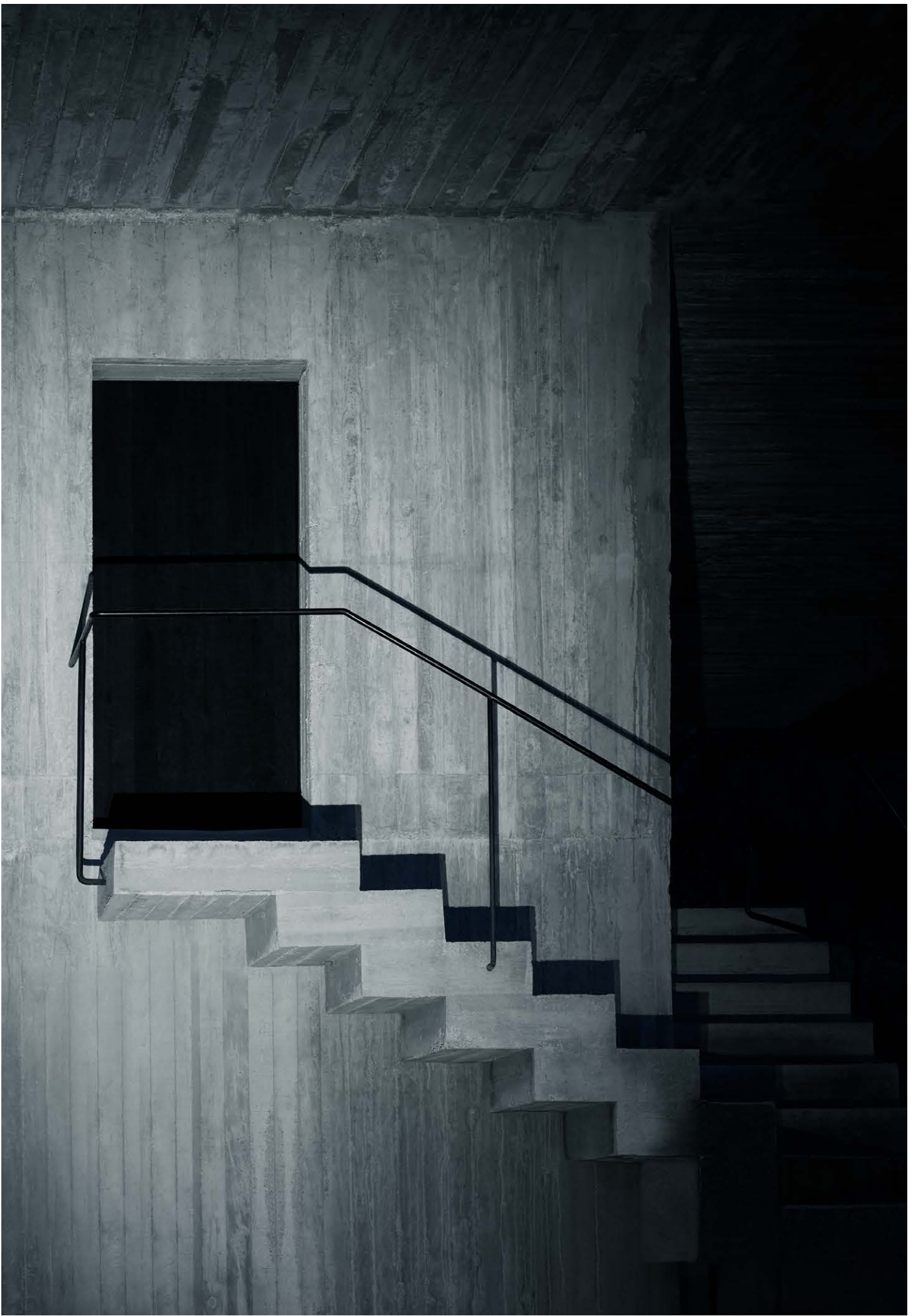

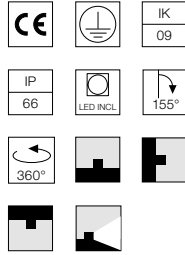
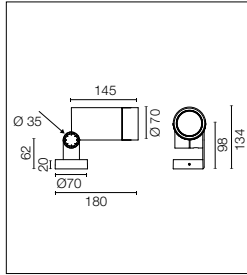

Source Power LED incluse. Équipée d'un snoot intégré pour un plus grand confort visuel: viseur asymétrique disponible en tant qu'accessoire. Les collimateurs sont des accessoires disponibles pour modifier la largeur du faisceau lumineux. Source d'alimentation électrique intégrée 220-240V ON/OFF. Support de montage minimum en L intégré. Équipée d'un câble en néoprène de 5m (10m sur commande) pour une connexion à distance; pour garantir l'étanchéité, il est conseillé d'utiliser des câbles flexibles conçus pour l'extérieur. Sur commande, version réglable 1-10V ou DALI avec source d'alimentation à distance 24Vdc.

Power LED source included. Equipped with an integrated snoot for higher visual comfort: the asymmetrical cut visor is available as an accessory. Collimators are available as an accessory to modify the beam opening. Integrated electric power supply 220-240V ON/OFF. Minimum L-shaped mounting support integrated. Equipped with a 5m neoprene cable (10m upon request) for remote connection. To guarantee its water tightness, it is recommended to use flexible cables designed for outdoor use. Upon request: 1-10V or DALI dimmable version with 24Vdc remote power supply.

2200K disponible sur demande.

2200K available on request.

Optic Narrow Spot 7°

Power Led: 3,5W - 168 lm ≠ FIXT 143 lm - 2700K/CRI 80 - 220-240V / 3,5W - 174 lm ≠ FIXT 149 lm - 3000K/CRI 80 - 220-240V / 3,5W - 180 lm ≠ FIXT 154 lm - 4000K/CRI 80 - 220-240V

2700K

Non Dimmable

○ F025R2AA001	626,00 €
● F025R2AA006	626,00 €
● F025R2AA012	626,00 €
● F025R2AA018	626,00 €
● F025R2AA030	626,00 €
● F025R2AA033	626,00 €

3000K

Non Dimmable

○ F025R3AA001	626,00 €
● F025R3AA006	626,00 €
● F025R3AA012	626,00 €
● F025R3AA018	626,00 €
● F025R3AA030	626,00 €
● F025R3AA033	626,00 €

4000K

Non Dimmable

○ F025R4AA001	626,00 €
● F025R4AA006	626,00 €
● F025R4AA012	626,00 €
● F025R4AA018	626,00 €
● F025R4AA030	626,00 €
● F025R4AA033	626,00 €

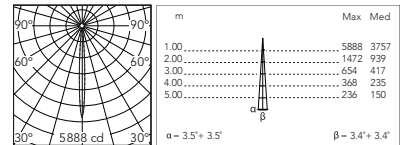

@ 3000K

Optic Spot 14°

Power Led: 7,9W - 671 lm ≠ FIXT 550 lm - 2700K/CRI 80 - 220-240V / 7,9W - 696 lm ≠ FIXT 571 lm - 3000K/CRI 80 - 220-240V / 7,9W - 720 lm ≠ FIXT 591 lm - 4000K/CRI 80 - 220-240V

2700K

Non Dimmable

○ F025R2BA001	626,00 €
● F025R2BA006	626,00 €
● F025R2BA012	626,00 €
● F025R2BA018	626,00 €
● F025R2BA030	626,00 €
● F025R2BA033	626,00 €

3000K

Non Dimmable

○ F025R3BA001	626,00 €
● F025R3BA006	626,00 €
● F025R3BA012	626,00 €
● F025R3BA018	626,00 €
● F025R3BA030	626,00 €
● F025R3BA033	626,00 €

4000K

Non Dimmable

○ F025R4BA001	626,00 €
● F025R4BA006	626,00 €
● F025R4BA012	626,00 €
● F025R4BA018	626,00 €
● F025R4BA030	626,00 €
● F025R4BA033	626,00 €

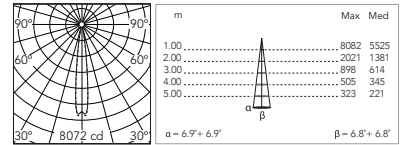

@ 3000K

Optic Medium Flood 24,5°

Power Led: 7,9W - 671 lm ≠ FIXT 499 lm - 2700K/CRI 80 - 220-240V / 7,9W - 696 lm ≠ FIXT 518 lm - 3000K/CRI 80 - 220-240V / 7,9W - 720 lm ≠ FIXT 536 lm - 4000K/CRI 80 - 220-240V

2700K

Non Dimmable

○ F025R2CA001	626,00 €
● F025R2CA006	626,00 €
● F025R2CA012	626,00 €
● F025R2CA018	626,00 €
● F025R2CA030	626,00 €
● F025R2CA033	626,00 €

3000K

Non Dimmable

○ F025R3CA001	626,00 €
● F025R3CA006	626,00 €
● F025R3CA012	626,00 €
● F025R3CA018	626,00 €
● F025R3CA030	626,00 €
● F025R3CA033	626,00 €

4000K

Non Dimmable

○ F025R4CA001	626,00 €
● F025R4CA006	626,00 €
● F025R4CA012	626,00 €
● F025R4CA018	626,00 €
● F025R4CA030	626,00 €
● F025R4CA033	626,00 €

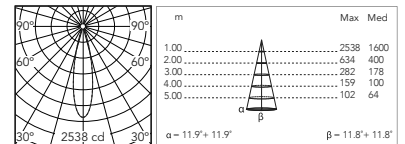

@ 3000K

Optic Flood 32°

Power Led: 7,9W - 671 lm ≠ FIXT 482 lm - 2700K/CRI 80 - 220-240V / 7,9W - 696 lm ≠ FIXT 500 lm - 3000K/CRI 80 - 220-240V / 7,9W - 720 lm ≠ FIXT 518 lm - 4000K/CRI 80 - 220-240V

2700K

Non Dimmable

○ F025R2DA001	626,00 €
● F025R2DA006	626,00 €
● F025R2DA012	626,00 €
● F025R2DA018	626,00 €
● F025R2DA030	626,00 €
● F025R2DA033	626,00 €

3000K

Non Dimmable

○ F025R3DA001	626,00 €
● F025R3DA006	626,00 €
● F025R3DA012	626,00 €
● F025R3DA018	626,00 €
● F025R3DA030	626,00 €
● F025R3DA033	626,00 €

4000K

Non Dimmable

○ F025R4DA001	626,00 €
● F025R4DA006	626,00 €
● F025R4DA012	626,00 €
● F025R4DA018	626,00 €
● F025R4DA030	626,00 €
● F025R4DA033	626,00 €

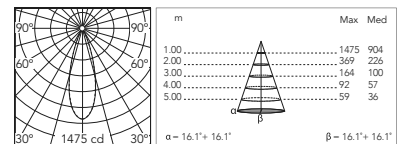

@ 3000K

Spine L 1 Ultra

Optic Wide Flood 49°

Power Led: 7,9W - 671 lm ≠ FIXT 480 lm - 2700K/CRI 80 - 220-240V / 7,9W - 696 lm ≠ FIXT 490 lm - 3000K/CRI 80 - 220-240V / 7,9W - 720 lm ≠ FIXT 505 lm - 4000K/CRI 80 - 220-240V

2700K

Non Dimmable

○ F025R2EA001	626,00 €
● F025R2EA006	626,00 €
● F025R2EA012	626,00 €
● F025R2EA018	626,00 €
● F025R2EA030	626,00 €
● F025R2EA033	626,00 €

3000K

Non Dimmable

○ F025R3EA001	626,00 €
● F025R3EA006	626,00 €
● F025R3EA012	626,00 €
● F025R3EA018	626,00 €
● F025R3EA030	626,00 €
● F025R3EA033	626,00 €

4000K

Non Dimmable

○ F025R4EA001	626,00 €
● F025R4EA006	626,00 €
● F025R4EA012	626,00 €
● F025R4EA018	626,00 €
● F025R4EA030	626,00 €
● F025R4EA033	626,00 €

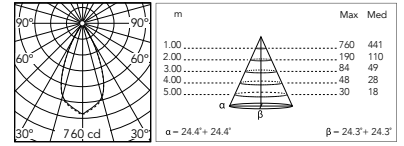

@ 3000K

Optic Elliptical 1 13,5° x 50°

Power Led: 7,9W - 671 lm ≠ FIXT 500 lm - 2700K/CRI 80 - 220-240V / 7,9W - 696 lm ≠ FIXT 519 lm - 3000K/CRI 80 - 220-240V / 7,9W - 720 lm ≠ FIXT 537 lm - 4000K/CRI 80 - 220-240V

2700K

Non Dimmable

○ F025R2FA001	626,00 €
● F025R2FA006	626,00 €
● F025R2FA012	626,00 €
● F025R2FA018	626,00 €
● F025R2FA030	626,00 €
● F025R2FA033	626,00 €

3000K

Non Dimmable

○ F025R3FA001	626,00 €
● F025R3FA006	626,00 €
● F025R3FA012	626,00 €
● F025R3FA018	626,00 €
● F025R3FA030	626,00 €
● F025R3FA033	626,00 €

4000K

Non Dimmable

○ F025R4FA001	626,00 €
● F025R4FA006	626,00 €
● F025R4FA012	626,00 €
● F025R4FA018	626,00 €
● F025R4FA030	626,00 €
● F025R4FA033	626,00 €

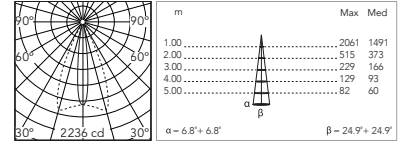

@ 3000K

Optic Elliptical 2 26° x 51°

Power Led: 7,9W - 671 lm ≠ FIXT 487 lm - 2700K/CRI 80 - 220-240V / 7,9W - 696 lm ≠ FIXT 505 lm - 3000K/CRI 80 - 220-240V / 7,9W - 720 lm ≠ FIXT 523 lm - 4000K/CRI 80 - 220-240V

2700K

Non Dimmable

○ F025R2GA001	626,00 €
● F025R2GA006	626,00 €
● F025R2GA012	626,00 €
● F025R2GA018	626,00 €
● F025R2GA030	626,00 €
● F025R2GA033	626,00 €

3000K

Non Dimmable

○ F025R3GA001	626,00 €
● F025R3GA006	626,00 €
● F025R3GA012	626,00 €
● F025R3GA018	626,00 €
● F025R3GA030	626,00 €
● F025R3GA033	626,00 €

4000K

Non Dimmable

○ F025R4GA001	626,00 €
● F025R4GA006	626,00 €
● F025R4GA012	626,00 €
● F025R4GA018	626,00 €
● F025R4GA030	626,00 €
● F025R4GA033	626,00 €

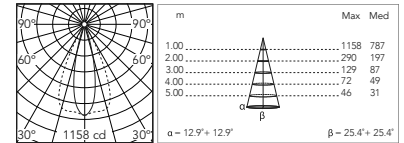

@ 3000K

Optic Wall Washer

Power Led: 7,9W - 671 lm ≠ FIXT 471 lm - 2700K/CRI 80 - 220-240V / 7,9W - 696 lm ≠ FIXT 489 lm - 3000K/CRI 80 - 220-240V / 7,9W - 720 lm ≠ FIXT 506 lm - 4000K/CRI 80 - 220-240V

2700K

Non Dimmable

○ F025R2HA001	626,00 €
● F025R2HA006	626,00 €
● F025R2HA012	626,00 €
● F025R2HA018	626,00 €
● F025R2HA030	626,00 €
● F025R2HA033	626,00 €

3000K

Non Dimmable

○ F025R3HA001	626,00 €
● F025R3HA006	626,00 €
● F025R3HA012	626,00 €
● F025R3HA018	626,00 €
● F025R3HA030	626,00 €
● F025R3HA033	626,00 €

4000K

Non Dimmable

○ F025R4HA001	626,00 €
● F025R4HA006	626,00 €
● F025R4HA012	626,00 €
● F025R4HA018	626,00 €
● F025R4HA030	626,00 €
● F025R4HA033	626,00 €

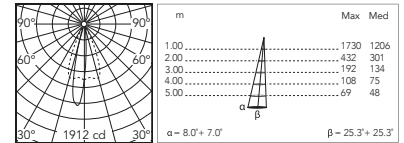

@ 3000K

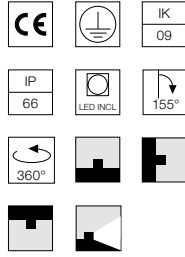
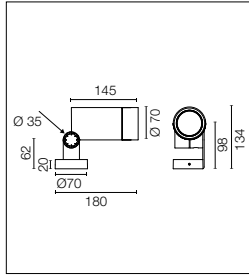

Source LED à basse consommation incluse. Équipée d'un snoot intégré pour un plus grand confort visuel: viseur asymétrique disponible en tant qu'accessoire. Les collimateurs sont des accessoires disponibles pour modifier la largeur du faisceau lumineux. Source d'alimentation électrique intégrée 220-240V ON/OFF. Support de montage minimum en L intégré. Équipée d'un câble en néoprène de 5m (10m sur commande) pour une connexion à distance; pour garantir l'étanchéité, il est conseillé d'utiliser des câbles flexibles conçus pour l'extérieur. Sur commande, version réglable 1-10V ou DALI avec source d'alimentation à distance 24Vdc.

Energy-efficient Power LED source included Equipped with an integrated snoot for higher visual comfort: the asymmetrical cut visor is available as an accessory. Collimators are available as an accessory to modify the beam opening. Integrated electric power supply 220-240V ON/OFF. Minimum L-shaped mounting support integrated. Equipped with a 5m neoprene cable (10m upon request) for remote connection. To guarantee its water tightness, it is recommended to use flexible cables designed for outdoor use. Upon request: 1-10V or DALI dimmable version with 24Vdc remote power supply.

Optic Spot 12°

Power Led: 10,5W - 920 lm ≠ FIXT 680 lm - 2700K/CRI 80 - 220-240V / 10,5W - 966 lm ≠ FIXT 706 lm - 3000K/CRI 80 - 220-240V / 10,5W - 1012 lm ≠ FIXT 730 lm - 4000K/CRI 80 - 220-240V

2700K

Non Dimmable

○ F025S2BA001	626,00 €
● F025S2BA006	626,00 €
● F025S2BA012	626,00 €
● F025S2BA018	626,00 €
● F025S2BA030	626,00 €
● F025S2BA033	626,00 €

3000K

Non Dimmable

○ F025S3BA001	626,00 €
● F025S3BA006	626,00 €
● F025S3BA012	626,00 €
● F025S3BA018	626,00 €
● F025S3BA030	626,00 €
● F025S3BA033	626,00 €

4000K

Non Dimmable

○ F025S4BA001	626,00 €
● F025S4BA006	626,00 €
● F025S4BA012	626,00 €
● F025S4BA018	626,00 €
● F025S4BA030	626,00 €
● F025S4BA033	626,00 €

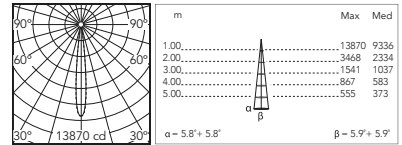

@ 3000K

Optic Medium Flood 26,5°

Power Led: 10,5W - 920 lm ≠ FIXT 594 lm - 2700K/CRI 80 - 220-240V / 10,5W - 966 lm ≠ FIXT 630 lm - 3000K/CRI 80 - 220-240V / 10,5W - 1012 lm ≠ FIXT 654 lm - 4000K/CRI 80 - 220-240V

2700K

Non Dimmable

○ F025S2CA001	626,00 €
● F025S2CA006	626,00 €
● F025S2CA012	626,00 €
● F025S2CA018	626,00 €
● F025S2CA030	626,00 €
● F025S2CA033	626,00 €

3000K

Non Dimmable

○ F025S3CA001	626,00 €
● F025S3CA006	626,00 €
● F025S3CA012	626,00 €
● F025S3CA018	626,00 €
● F025S3CA030	626,00 €
● F025S3CA033	626,00 €

4000K

Non Dimmable

○ F025S4CA001	626,00 €
● F025S4CA006	626,00 €
● F025S4CA012	626,00 €
● F025S4CA018	626,00 €
● F025S4CA030	626,00 €
● F025S4CA033	626,00 €

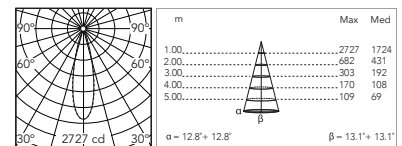

@ 3000K

Optic Flood 33,5°

Power Led: 10,5W - 920 lm ≠ FIXT 592 lm - 2700K/CRI 80 - 220-240V / 10,5W - 966 lm ≠ FIXT 627 lm - 3000K/CRI 80 - 220-240V / 10,5W - 1012 lm ≠ FIXT 651 lm - 4000K/CRI 80 - 220-240V

2700K

Non Dimmable

○ F025S2DA001	626,00 €
● F025S2DA006	626,00 €
● F025S2DA012	626,00 €
● F025S2DA018	626,00 €
● F025S2DA030	626,00 €
● F025S2DA033	626,00 €

3000K

Non Dimmable

○ F025S3DA001	626,00 €
● F025S3DA006	626,00 €
● F025S3DA012	626,00 €
● F025S3DA018	626,00 €
● F025S3DA030	626,00 €
● F025S3DA033	626,00 €

4000K

Non Dimmable

○ F025S4DA001	626,00 €
● F025S4DA006	626,00 €
● F025S4DA012	626,00 €
● F025S4DA018	626,00 €
● F025S4DA030	626,00 €
● F025S4DA033	626,00 €

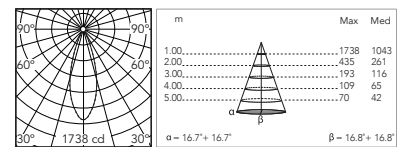

@ 3000K

Optic Wide Flood 50°

Power Led: 10,5W - 920 lm ≠ FIXT 591 lm - 2700K/CRI 80 - 220-240V / 10,5W - 966 lm ≠ FIXT 619 lm - 3000K/CRI 80 - 220-240V / 10,5W - 1012 lm ≠ FIXT 650 lm - 4000K/CRI 80 - 220-240V

2700K

Non Dimmable

○ F025S2EA001	626,00 €
● F025S2EA006	626,00 €
● F025S2EA012	626,00 €
● F025S2EA018	626,00 €
● F025S2EA030	626,00 €
● F025S2EA033	626,00 €

3000K

Non Dimmable

○ F025S3EA001	626,00 €
● F025S3EA006	626,00 €
● F025S3EA012	626,00 €
● F025S3EA018	626,00 €
● F025S3EA030	626,00 €
● F025S3EA033	626,00 €

4000K

Non Dimmable

○ F025S4EA001	626,00 €
● F025S4EA006	626,00 €
● F025S4EA012	626,00 €
● F025S4EA018	626,00 €
● F025S4EA030	626,00 €
● F025S4EA033	626,00 €

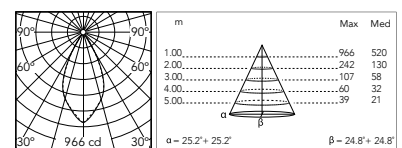

@ 3000K

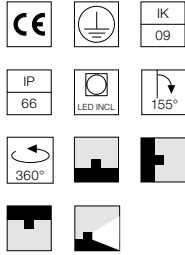
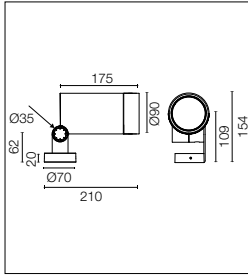

Source Power LED incluse. Équipée d'un snoot intégré pour un plus grand confort visuel: viseur asymétrique disponible en tant qu'accessoire. Les colimateurs sont des accessoires disponibles pour modifier la largeur du faisceau lumineux. Source d'alimentation électrique intégrée 220-240V ON/OFF et réglable 1-10V ou DALI. Support de montage minimum en L intégré. Équipée d'un câble en néoprène de 5m (10m sur commande) pour une connexion à distance; pour garantir l'étanchéité, il est conseillé d'utiliser des câbles flexibles conçus pour l'extérieur.

Power LED source included. Equipped with an integrated snoot for higher visual comfort: the asymmetrical cut visor is available as an accessory. Collimators are available as an accessory to modify the beam opening. Integrated electric power supply 220-240V ON/OFF and adjustable 1-10V or DALI. Minimum L-shaped mounting support integrated. Equipped with a 5m neoprene cable (10m upon request) for remote connection. To guarantee its water tightness, it is recommended to use flexible cables designed for outdoor use.

Optic Narrow Spot
2200K disponible sur demande.

Optic Narrow Spot
2200K available on request.

Optic Narrow Spot 6°

Power Led: 4,1W - 248 lm ≠ FIXT 230 lm - 2700K/CRI 80 - 220-240V / 4,1W - 258 lm ≠ FIXT 239 lm - 3000K/CRI 80 - 220-240V / 4,1W - 267 lm ≠ FIXT 247 lm - 4000K/CRI 80 - 220-240V

2700K

Non Dimmable

- F026R2AA001 730,00 €
- F026R2AA006 730,00 €
- F026R2AA012 730,00 €
- F026R2AA018 730,00 €
- F026R2AA030 730,00 €
- F026R2AA033 730,00 €
- 1-10V
- F026R2AB001 793,00 €
- F026R2AB006 793,00 €
- F026R2AB012 793,00 €
- F026R2AB018 793,00 €
- F026R2AB030 793,00 €
- F026R2AB033 793,00 €
- Dali
- F026R2AD001 793,00 €
- F026R2AD006 793,00 €
- F026R2AD012 793,00 €
- F026R2AD018 793,00 €
- F026R2AD030 793,00 €
- F026R2AD033 793,00 €

3000K

Non Dimmable

- F026R3AA001 730,00 €
- F026R3AA006 730,00 €
- F026R3AA012 730,00 €
- F026R3AA018 730,00 €
- F026R3AA030 730,00 €
- F026R3AA033 730,00 €
- 1-10V
- F026R3AB001 793,00 €
- F026R3AB006 793,00 €
- F026R3AB012 793,00 €
- F026R3AB018 793,00 €
- F026R3AB030 793,00 €
- F026R3AB033 793,00 €
- Dali
- F026R3AD001 793,00 €
- F026R3AD006 793,00 €
- F026R3AD012 793,00 €
- F026R3AD018 793,00 €
- F026R3AD030 793,00 €
- F026R3AD033 793,00 €

4000K

Non Dimmable

- F026R4AA001 730,00 €
- F026R4AA006 730,00 €
- F026R4AA012 730,00 €
- F026R4AA018 730,00 €
- F026R4AA030 730,00 €
- F026R4AA033 730,00 €
- 1-10V
- F026R4AB001 793,00 €
- F026R4AB006 793,00 €
- F026R4AB012 793,00 €
- F026R4AB018 793,00 €
- F026R4AB030 793,00 €
- F026R4AB033 793,00 €
- Dali
- F026R4AD001 793,00 €
- F026R4AD006 793,00 €
- F026R4AD012 793,00 €
- F026R4AD018 793,00 €
- F026R4AD030 793,00 €
- F026R4AD033 793,00 €

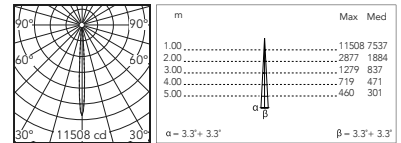

@ 3000K

Optic Spot 9,5°

Power Led: 10,5W - 920 lm ≠ FIXT 769 lm - 2700K/CRI 80 - 220-240V / 10,5W - 966 lm ≠ FIXT 808 lm - 3000K/CRI 80 - 220-240V / 10,5W - 1012 lm ≠ FIXT 846 lm - 4000K/CRI 80 - 220-240V

2700K

Non Dimmable

- F026R2BA001 730,00 €
- F026R2BA006 730,00 €
- F026R2BA012 730,00 €
- F026R2BA018 730,00 €
- F026R2BA030 730,00 €
- F026R2BA033 730,00 €
- 1-10V
- F026R2BB001 793,00 €
- F026R2BB006 793,00 €
- F026R2BB012 793,00 €
- F026R2BB018 793,00 €
- F026R2BB030 793,00 €
- F026R2BB033 793,00 €
- Dali
- F026R2BD001 793,00 €
- F026R2BD006 793,00 €
- F026R2BD012 793,00 €
- F026R2BD018 793,00 €
- F026R2BD030 793,00 €
- F026R2BD033 793,00 €

3000K

Non Dimmable

- F026R3BA001 730,00 €
- F026R3BA006 730,00 €
- F026R3BA012 730,00 €
- F026R3BA018 730,00 €
- F026R3BA030 730,00 €
- F026R3BA033 730,00 €
- 1-10V
- F026R3BB001 793,00 €
- F026R3BB006 793,00 €
- F026R3BB012 793,00 €
- F026R3BB018 793,00 €
- F026R3BB030 793,00 €
- F026R3BB033 793,00 €
- Dali
- F026R3BD001 793,00 €
- F026R3BD006 793,00 €
- F026R3BD012 793,00 €
- F026R3BD018 793,00 €
- F026R3BD030 793,00 €
- F026R3BD033 793,00 €

4000K

Non Dimmable

- F026R4BA001 730,00 €
- F026R4BA006 730,00 €
- F026R4BA012 730,00 €
- F026R4BA018 730,00 €
- F026R4BA030 730,00 €
- F026R4BA033 730,00 €
- 1-10V
- F026R4BB001 793,00 €
- F026R4BB006 793,00 €
- F026R4BB012 793,00 €
- F026R4BB018 793,00 €
- F026R4BB030 793,00 €
- F026R4BB033 793,00 €
- Dali
- F026R4BD001 793,00 €
- F026R4BD006 793,00 €
- F026R4BD012 793,00 €
- F026R4BD018 793,00 €
- F026R4BD030 793,00 €
- F026R4BD033 793,00 €

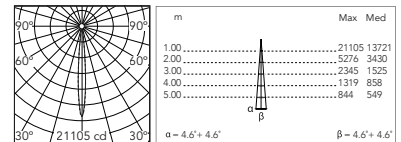

@ 3000K

Spine L 2 Ultra

Optic Medium Flood 28°

Power Led: 10,5W - 920 lm ≠ FIXT 715 lm - 2700K/CRI 80 - 220-240V / 10,5W - 966 lm ≠ FIXT 742 lm - 3000K/CRI 80 - 220-240V / 10,5W - 1012 lm ≠ FIXT 767 lm - 4000K/CRI 80 - 220-240V

2700K		3000K		4000K	
Non Dimmable		Non Dimmable		Non Dimmable	
○ F026R2CA001	730,00 €	○ F026R3CA001	730,00 €	○ F026R4CA001	730,00 €
● F026R2CA006	730,00 €	● F026R3CA006	730,00 €	● F026R4CA006	730,00 €
● F026R2CA012	730,00 €	● F026R3CA012	730,00 €	● F026R4CA012	730,00 €
● F026R2CA018	730,00 €	● F026R3CA018	730,00 €	● F026R4CA018	730,00 €
● F026R2CA030	730,00 €	● F026R3CA030	730,00 €	● F026R4CA030	730,00 €
● F026R2CA033	730,00 €	● F026R3CA033	730,00 €	● F026R4CA033	730,00 €
1-10V		1-10V		1-10V	
○ F026R2CB001	793,00 €	○ F026R3CB001	793,00 €	○ F026R4CB001	793,00 €
● F026R2CB006	793,00 €	● F026R3CB006	793,00 €	● F026R4CB006	793,00 €
● F026R2CB012	793,00 €	● F026R3CB012	793,00 €	● F026R4CB012	793,00 €
● F026R2CB018	793,00 €	● F026R3CB018	793,00 €	● F026R4CB018	793,00 €
● F026R2CB030	793,00 €	● F026R3CB030	793,00 €	● F026R4CB030	793,00 €
● F026R2CB033	793,00 €	● F026R3CB033	793,00 €	● F026R4CB033	793,00 €
Dali		Dali		Dali	
○ F026R2CD001	793,00 €	○ F026R3CD001	793,00 €	○ F026R4CD001	793,00 €
● F026R2CD006	793,00 €	● F026R3CD006	793,00 €	● F026R4CD006	793,00 €
● F026R2CD012	793,00 €	● F026R3CD012	793,00 €	● F026R4CD012	793,00 €
● F026R2CD018	793,00 €	● F026R3CD018	793,00 €	● F026R4CD018	793,00 €
● F026R2CD030	793,00 €	● F026R3CD030	793,00 €	● F026R4CD030	793,00 €
● F026R2CD033	793,00 €	● F026R3CD033	793,00 €	● F026R4CD033	793,00 €

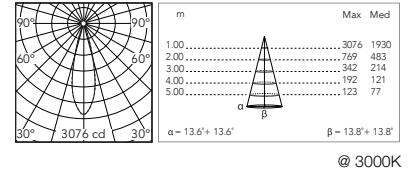

Optic Flood 33°

Power Led: 10,5W - 920 lm ≠ FIXT 695 lm - 2700K/CRI 80 - 220-240V / 10,5W - 966 lm ≠ FIXT 721 lm - 3000K/CRI 80 - 220-240V / 10,5W - 1012 lm ≠ FIXT 746 lm - 4000K/CRI 80 - 220-240V

2700K		3000K		4000K	
Non Dimmable		Non Dimmable		Non Dimmable	
○ F026R2DA001	730,00 €	○ F026R3DA001	730,00 €	○ F026R4DA001	730,00 €
● F026R2DA006	730,00 €	● F026R3DA006	730,00 €	● F026R4DA006	730,00 €
● F026R2DA012	730,00 €	● F026R3DA012	730,00 €	● F026R4DA012	730,00 €
● F026R2DA018	730,00 €	● F026R3DA018	730,00 €	● F026R4DA018	730,00 €
● F026R2DA030	730,00 €	● F026R3DA030	730,00 €	● F026R4DA030	730,00 €
● F026R2DA033	730,00 €	● F026R3DA033	730,00 €	● F026R4DA033	730,00 €
1-10V		1-10V		1-10V	
○ F026R2DB001	793,00 €	○ F026R3DB001	793,00 €	○ F026R4DB001	793,00 €
● F026R2DB006	793,00 €	● F026R3DB006	793,00 €	● F026R4DB006	793,00 €
● F026R2DB012	793,00 €	● F026R3DB012	793,00 €	● F026R4DB012	793,00 €
● F026R2DB018	793,00 €	● F026R3DB018	793,00 €	● F026R4DB018	793,00 €
● F026R2DB030	793,00 €	● F026R3DB030	793,00 €	● F026R4DB030	793,00 €
● F026R2DB033	793,00 €	● F026R3DB033	793,00 €	● F026R4DB033	793,00 €
Dali		Dali		Dali	
○ F026R2DD001	793,00 €	○ F026R3DD001	793,00 €	○ F026R4DD001	793,00 €
● F026R2DD006	793,00 €	● F026R3DD006	793,00 €	● F026R4DD006	793,00 €
● F026R2DD012	793,00 €	● F026R3DD012	793,00 €	● F026R4DD012	793,00 €
● F026R2DD018	793,00 €	● F026R3DD018	793,00 €	● F026R4DD018	793,00 €
● F026R2DD030	793,00 €	● F026R3DD030	793,00 €	● F026R4DD030	793,00 €
● F026R2DD033	793,00 €	● F026R3DD033	793,00 €	● F026R4DD033	793,00 €

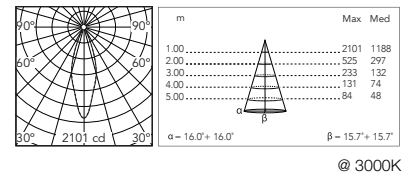

Optic Wide Flood 51°

Power Led: 10,5W - 920 lm ≠ FIXT 711 lm - 2700K/CRI 80 - 220-240V / 10,5W - 966 lm ≠ FIXT 741 lm - 3000K/CRI 80 - 220-240V / 10,5W - 1012 lm ≠ FIXT 778 lm - 4000K/CRI 80 - 220-240V

2700K		3000K		4000K	
Non Dimmable		Non Dimmable		Non Dimmable	
○ F026R2EA001	730,00 €	○ F026R3EA001	730,00 €	○ F026R4EA001	730,00 €
● F026R2EA006	730,00 €	● F026R3EA006	730,00 €	● F026R4EA006	730,00 €
● F026R2EA012	730,00 €	● F026R3EA012	730,00 €	● F026R4EA012	730,00 €
● F026R2EA018	730,00 €	● F026R3EA018	730,00 €	● F026R4EA018	730,00 €
● F026R2EA030	730,00 €	● F026R3EA030	730,00 €	● F026R4EA030	730,00 €
● F026R2EA033	730,00 €	● F026R3EA033	730,00 €	● F026R4EA033	730,00 €
1-10V		1-10V		1-10V	
○ F026R2EB001	793,00 €	○ F026R3EB001	793,00 €	○ F026R4EB001	793,00 €
● F026R2EB006	793,00 €	● F026R3EB006	793,00 €	● F026R4EB006	793,00 €
● F026R2EB012	793,00 €	● F026R3EB012	793,00 €	● F026R4EB012	793,00 €
● F026R2EB018	793,00 €	● F026R3EB018	793,00 €	● F026R4EB018	793,00 €
● F026R2EB030	793,00 €	● F026R3EB030	793,00 €	● F026R4EB030	793,00 €
● F026R2EB033	793,00 €	● F026R3EB033	793,00 €	● F026R4EB033	793,00 €
Dali		Dali		Dali	
○ F026R2ED001	793,00 €	○ F026R3ED001	793,00 €	○ F026R4ED001	793,00 €
● F026R2ED006	793,00 €	● F026R3ED006	793,00 €	● F026R4ED006	793,00 €
● F026R2ED012	793,00 €	● F026R3ED012	793,00 €	● F026R4ED012	793,00 €
● F026R2ED018	793,00 €	● F026R3ED018	793,00 €	● F026R4ED018	793,00 €
● F026R2ED030	793,00 €	● F026R3ED030	793,00 €	● F026R4ED030	793,00 €
● F026R2ED033	793,00 €	● F026R3ED033	793,00 €	● F026R4ED033	793,00 €

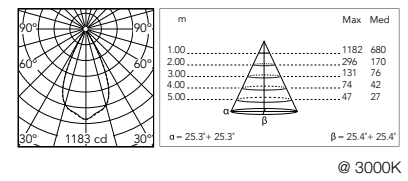

Spine L 2 Ultra

Optic Elliptical 1 9,5° x 48°

Power Led: 10,5W - 920 lm ≠ FIXT 717 lm - 2700K/CRI 80 - 220-240V / 10,5W - 966 lm ≠ FIXT 744 lm - 3000K/CRI 80 - 220-240V / 10,5W - 1012 lm ≠ FIXT 770 lm - 4000K/CRI 80 - 220-240V

2700K		3000K		4000K	
Non Dimmable		Non Dimmable		Non Dimmable	
○ F026R2FA001	730,00 €	○ F026R3FA001	730,00 €	○ F026R4FA001	730,00 €
● F026R2FA006	730,00 €	● F026R3FA006	730,00 €	● F026R4FA006	730,00 €
● F026R2FA012	730,00 €	● F026R3FA012	730,00 €	● F026R4FA012	730,00 €
● F026R2FA018	730,00 €	● F026R3FA018	730,00 €	● F026R4FA018	730,00 €
● F026R2FA030	730,00 €	● F026R3FA030	730,00 €	● F026R4FA030	730,00 €
● F026R2FA033	730,00 €	● F026R3FA033	730,00 €	● F026R4FA033	730,00 €
1-10V					
○ F026R2FB001	793,00 €	○ F026R3FB001	793,00 €	○ F026R4FB001	793,00 €
● F026R2FB006	793,00 €	● F026R3FB006	793,00 €	● F026R4FB006	793,00 €
● F026R2FB012	793,00 €	● F026R3FB012	793,00 €	● F026R4FB012	793,00 €
● F026R2FB018	793,00 €	● F026R3FB018	793,00 €	● F026R4FB018	793,00 €
● F026R2FB030	793,00 €	● F026R3FB030	793,00 €	● F026R4FB030	793,00 €
● F026R2FB033	793,00 €	● F026R3FB033	793,00 €	● F026R4FB033	793,00 €
Dali					
○ F026R2FD001	793,00 €	○ F026R3FD001	793,00 €	○ F026R4FD001	793,00 €
● F026R2FD006	793,00 €	● F026R3FD006	793,00 €	● F026R4FD006	793,00 €
● F026R2FD012	793,00 €	● F026R3FD012	793,00 €	● F026R4FD012	793,00 €
● F026R2FD018	793,00 €	● F026R3FD018	793,00 €	● F026R4FD018	793,00 €
● F026R2FD030	793,00 €	● F026R3FD030	793,00 €	● F026R4FD030	793,00 €
● F026R2FD033	793,00 €	● F026R3FD033	793,00 €	● F026R4FD033	793,00 €

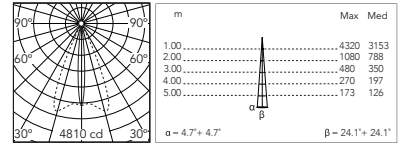

@ 3000K

Optic Elliptical 2 24° x 50°

Power Led: 10,5W - 920 lm ≠ FIXT 699 lm - 2700K/CRI 80 - 220-240V / 10,5W - 966 lm ≠ FIXT 725 lm - 3000K/CRI 80 - 220-240V / 10,5W - 1012 lm ≠ FIXT 750 lm - 4000K/CRI 80 - 220-240V

2700K		3000K		4000K	
Non Dimmable		Non Dimmable		Non Dimmable	
○ F026R2GA001	730,00 €	○ F026R3GA001	730,00 €	○ F026R4GA001	730,00 €
● F026R2GA006	730,00 €	● F026R3GA006	730,00 €	● F026R4GA006	730,00 €
● F026R2GA012	730,00 €	● F026R3GA012	730,00 €	● F026R4GA012	730,00 €
● F026R2GA018	730,00 €	● F026R3GA018	730,00 €	● F026R4GA018	730,00 €
● F026R2GA030	730,00 €	● F026R3GA030	730,00 €	● F026R4GA030	730,00 €
● F026R2GA033	730,00 €	● F026R3GA033	730,00 €	● F026R4GA033	730,00 €
1-10V					
○ F026R2GB001	793,00 €	○ F026R3GB001	793,00 €	○ F026R4GB001	793,00 €
● F026R2GB006	793,00 €	● F026R3GB006	793,00 €	● F026R4GB006	793,00 €
● F026R2GB012	793,00 €	● F026R3GB012	793,00 €	● F026R4GB012	793,00 €
● F026R2GB018	793,00 €	● F026R3GB018	793,00 €	● F026R4GB018	793,00 €
● F026R2GB030	793,00 €	● F026R3GB030	793,00 €	● F026R4GB030	793,00 €
● F026R2GB033	793,00 €	● F026R3GB033	793,00 €	● F026R4GB033	793,00 €
Dali					
○ F026R2GD001	793,00 €	○ F026R3GD001	793,00 €	○ F026R4GD001	793,00 €
● F026R2GD006	793,00 €	● F026R3GD006	793,00 €	● F026R4GD006	793,00 €
● F026R2GD012	793,00 €	● F026R3GD012	793,00 €	● F026R4GD012	793,00 €
● F026R2GD018	793,00 €	● F026R3GD018	793,00 €	● F026R4GD018	793,00 €
● F026R2GD030	793,00 €	● F026R3GD030	793,00 €	● F026R4GD030	793,00 €
● F026R2GD033	793,00 €	● F026R3GD033	793,00 €	● F026R4GD033	793,00 €

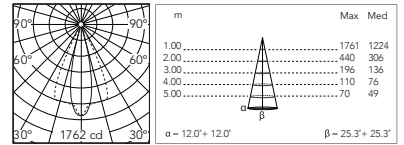

@ 3000K

Optic Wall Washer

Power Led: 10,5W - 920 lm ≠ FIXT 673 lm - 2700K/CRI 80 - 220-240V / 10,5W - 966 lm ≠ FIXT 698 lm - 3000K/CRI 80 - 220-240V / 10,5W - 1012 lm ≠ FIXT 672 lm - 4000K/CRI 80 - 220-240V

2700K		3000K		4000K	
Non Dimmable		Non Dimmable		Non Dimmable	
○ F026R2HA001	730,00 €	○ F026R3HA001	730,00 €	○ F026R4HA001	730,00 €
● F026R2HA006	730,00 €	● F026R3HA006	730,00 €	● F026R4HA006	730,00 €
● F026R2HA012	730,00 €	● F026R3HA012	730,00 €	● F026R4HA012	730,00 €
● F026R2HA018	730,00 €	● F026R3HA018	730,00 €	● F026R4HA018	730,00 €
● F026R2HA030	730,00 €	● F026R3HA030	730,00 €	● F026R4HA030	730,00 €
● F026R2HA033	730,00 €	● F026R3HA033	730,00 €	● F026R4HA033	730,00 €
1-10V					
○ F026R2HB001	793,00 €	○ F026R3HB001	793,00 €	○ F026R4HB001	793,00 €
● F026R2HB006	793,00 €	● F026R3HB006	793,00 €	● F026R4HB006	793,00 €
● F026R2HB012	793,00 €	● F026R3HB012	793,00 €	● F026R4HB012	793,00 €
● F026R2HB018	793,00 €	● F026R3HB018	793,00 €	● F026R4HB018	793,00 €
● F026R2HB030	793,00 €	● F026R3HB030	793,00 €	● F026R4HB030	793,00 €
● F026R2HB033	793,00 €	● F026R3HB033	793,00 €	● F026R4HB033	793,00 €
Dali					
○ F026R2HD001	793,00 €	○ F026R3HD001	793,00 €	○ F026R4HD001	793,00 €
● F026R2HD006	793,00 €	● F026R3HD006	793,00 €	● F026R4HD006	793,00 €
● F026R2HD012	793,00 €	● F026R3HD012	793,00 €	● F026R4HD012	793,00 €
● F026R2HD018	793,00 €	● F026R3HD018	793,00 €	● F026R4HD018	793,00 €
● F026R2HD030	793,00 €	● F026R3HD030	793,00 €	● F026R4HD030	793,00 €
● F026R2HD033	793,00 €	● F026R3HD033	793,00 €	● F026R4HD033	793,00 €

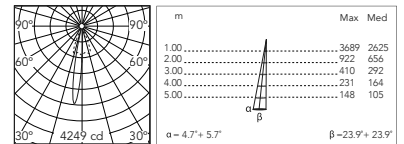

@ 3000K

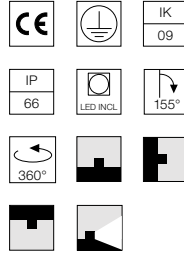
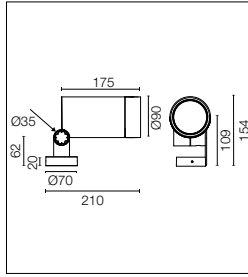

Source LED à basse consommation incluse. Équipée d'un snoot intégré pour un plus grand confort visuel: viseur asymétrique disponible en tant qu'accessoire. Les collimateurs sont des accessoires disponibles pour modifier la largeur du faisceau lumineux. Source d'alimentation électrique intégrée 220-240V ON/OFF et réglable 1-10V ou DALI. Support de montage minimum en L intégré. Équipée d'un câble en néoprène de 5m (10m sur commande) pour une connexion à distance; pour garantir l'étanchéité, il est conseillé d'utiliser des câbles flexibles conçus pour l'extérieur.

Energy-efficient Power LED source included Equipped with an integrated snoot for higher visual comfort: the asymmetrical cut visor is available as an accessory. Collimators are available as an accessory to modify the beam opening. Integrated electric power supply 220-240V ON/OFF and adjustable 1-10V or DALI. Minimum L-shaped mounting support integrated. Equipped with a 5m neoprene cable (10m upon request) for remote connection. To guarantee its water tightness, it is recommended to use flexible cables designed for outdoor use.

2200K disponible sur demande.

2200K available on request.

Optic Spot 14,5°

Power Led: 17W - 1739 lm ≠ FIXT 1443 lm - 2700K/CRI 80 - 220-240V / 17W - 1803 lm ≠ FIXT 1497 lm - 3000K/CRI 80 - 220-240V / 17W - 1868 lm ≠ FIXT 1548 lm - 4000K/CRI 80 - 220-240V

2700K		3000K		4000K	
Non Dimmable		Non Dimmable		Non Dimmable	
○ F026S2BA001	730,00 €	○ F026S3BA001	730,00 €	○ F026S4BA001	730,00 €
● F026S2BA006	730,00 €	● F026S3BA006	730,00 €	● F026S4BA006	730,00 €
● F026S2BA012	730,00 €	● F026S3BA012	730,00 €	● F026S4BA012	730,00 €
● F026S2BA018	730,00 €	● F026S3BA018	730,00 €	● F026S4BA018	730,00 €
● F026S2BA030	730,00 €	● F026S3BA030	730,00 €	● F026S4BA030	730,00 €
● F026S2BA033	730,00 €	● F026S3BA033	730,00 €	● F026S4BA033	730,00 €
1-10V					
○ F026S2BB001	793,00 €	○ F026S3BB001	793,00 €	○ F026S4BB001	793,00 €
● F026S2BB006	793,00 €	● F026S3BB006	793,00 €	● F026S4BB006	793,00 €
● F026S2BB012	793,00 €	● F026S3BB012	793,00 €	● F026S4BB012	793,00 €
● F026S2BB018	793,00 €	● F026S3BB018	793,00 €	● F026S4BB018	793,00 €
● F026S2BB030	793,00 €	● F026S3BB030	793,00 €	● F026S4BB030	793,00 €
● F026S2BB033	793,00 €	● F026S3BB033	793,00 €	● F026S4BB033	793,00 €
Dali					
○ F026S2BD001	793,00 €	○ F026S3BD001	793,00 €	○ F026S4BD001	793,00 €
● F026S2BD006	793,00 €	● F026S3BD006	793,00 €	● F026S4BD006	793,00 €
● F026S2BD012	793,00 €	● F026S3BD012	793,00 €	● F026S4BD012	793,00 €
● F026S2BD018	793,00 €	● F026S3BD018	793,00 €	● F026S4BD018	793,00 €
● F026S2BD030	793,00 €	● F026S3BD030	793,00 €	● F026S4BD030	793,00 €
● F026S2BD033	793,00 €	● F026S3BD033	793,00 €	● F026S4BD033	793,00 €

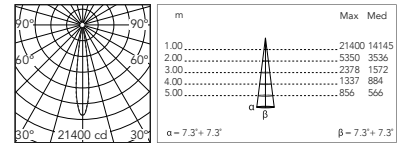

@ 3000K

Optic Medium Flood 26°

Power Led: 17W - 1739 lm ≠ FIXT 1336 lm - 2700K/CRI 80 - 220-240V / 17W - 1803 lm ≠ FIXT 1386 lm - 3000K/CRI 80 - 220-240V / 17W - 1868 lm ≠ FIXT 1434 lm - 4000K/CRI 80 - 220-240V

2700K		3000K		4000K	
Non Dimmable		Non Dimmable		Non Dimmable	
○ F026S2CA001	730,00 €	○ F026S3CA001	730,00 €	○ F026S4CA001	730,00 €
● F026S2CA006	730,00 €	● F026S3CA006	730,00 €	● F026S4CA006	730,00 €
● F026S2CA012	730,00 €	● F026S3CA012	730,00 €	● F026S4CA012	730,00 €
● F026S2CA018	730,00 €	● F026S3CA018	730,00 €	● F026S4CA018	730,00 €
● F026S2CA030	730,00 €	● F026S3CA030	730,00 €	● F026S4CA030	730,00 €
● F026S2CA033	730,00 €	● F026S3CA033	730,00 €	● F026S4CA033	730,00 €
1-10V					
○ F026S2CB001	793,00 €	○ F026S3CB001	793,00 €	○ F026S4CB001	793,00 €
● F026S2CB006	793,00 €	● F026S3CB006	793,00 €	● F026S4CB006	793,00 €
● F026S2CB012	793,00 €	● F026S3CB012	793,00 €	● F026S4CB012	793,00 €
● F026S2CB018	793,00 €	● F026S3CB018	793,00 €	● F026S4CB018	793,00 €
● F026S2CB030	793,00 €	● F026S3CB030	793,00 €	● F026S4CB030	793,00 €
● F026S2CB033	793,00 €	● F026S3CB033	793,00 €	● F026S4CB033	793,00 €
Dali					
○ F026S2CD001	793,00 €	○ F026S3CD001	793,00 €	○ F026S4CD001	793,00 €
● F026S2CD006	793,00 €	● F026S3CD006	793,00 €	● F026S4CD006	793,00 €
● F026S2CD012	793,00 €	● F026S3CD012	793,00 €	● F026S4CD012	793,00 €
● F026S2CD018	793,00 €	● F026S3CD018	793,00 €	● F026S4CD018	793,00 €
● F026S2CD030	793,00 €	● F026S3CD030	793,00 €	● F026S4CD030	793,00 €
● F026S2CD033	793,00 €	● F026S3CD033	793,00 €	● F026S4CD033	793,00 €

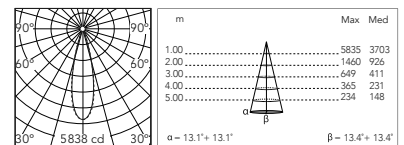

@ 3000K

Spine L 2 Ultra Hp

Optic Flood 36°

Power Led: 17W - 1739 lm ≠ FIXT 1302 lm - 2700K/CRI 80 - 220-240V / 17W - 1803 lm ≠ FIXT 1351 lm - 3000K/CRI 80 - 220-240V / 17W - 1868 lm ≠ FIXT 1397 lm - 4000K/CRI 80 - 220-240V

2700K		3000K		4000K	
Non Dimmable		Non Dimmable		Non Dimmable	
○ F026S2DA001	730,00 €	○ F026S3DA001	730,00 €	○ F026S4DA001	730,00 €
● F026S2DA006	730,00 €	● F026S3DA006	730,00 €	● F026S4DA006	730,00 €
● F026S2DA012	730,00 €	● F026S3DA012	730,00 €	● F026S4DA012	730,00 €
● F026S2DA018	730,00 €	● F026S3DA018	730,00 €	● F026S4DA018	730,00 €
● F026S2DA030	730,00 €	● F026S3DA030	730,00 €	● F026S4DA030	730,00 €
● F026S2DA033	730,00 €	● F026S3DA033	730,00 €	● F026S4DA033	730,00 €
1-10V					
○ F026S2DB001	793,00 €	○ F026S3DB001	793,00 €	○ F026S4DB001	793,00 €
● F026S2DB006	793,00 €	● F026S3DB006	793,00 €	● F026S4DB006	793,00 €
● F026S2DB012	793,00 €	● F026S3DB012	793,00 €	● F026S4DB012	793,00 €
● F026S2DB018	793,00 €	● F026S3DB018	793,00 €	● F026S4DB018	793,00 €
● F026S2DB030	793,00 €	● F026S3DB030	793,00 €	● F026S4DB030	793,00 €
● F026S2DB033	793,00 €	● F026S3DB033	793,00 €	● F026S4DB033	793,00 €
Dali					
○ F026S2DD001	793,00 €	○ F026S3DD001	793,00 €	○ F026S4DD001	793,00 €
● F026S2DD006	793,00 €	● F026S3DD006	793,00 €	● F026S4DD006	793,00 €
● F026S2DD012	793,00 €	● F026S3DD012	793,00 €	● F026S4DD012	793,00 €
● F026S2DD018	793,00 €	● F026S3DD018	793,00 €	● F026S4DD018	793,00 €
● F026S2DD030	793,00 €	● F026S3DD030	793,00 €	● F026S4DD030	793,00 €
● F026S2DD033	793,00 €	● F026S3DD033	793,00 €	● F026S4DD033	793,00 €

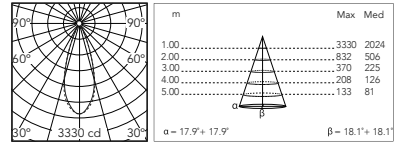

@ 3000K

Optic Wide Flood 52°

Power Led: 17W - 1739 lm ≠ FIXT 1303 lm - 2700K/CRI 80 - 220-240V / 17W - 1803 lm ≠ FIXT 1357 lm - 3000K/CRI 80 - 220-240V / 17W - 1868 lm ≠ FIXT 1411 lm - 4000K/CRI 80 - 220-240V

2700K		3000K		4000K	
Non Dimmable		Non Dimmable		Non Dimmable	
○ F026S2EA001	730,00 €	○ F026S3EA001	730,00 €	○ F026S4EA001	730,00 €
● F026S2EA006	730,00 €	● F026S3EA006	730,00 €	● F026S4EA006	730,00 €
● F026S2EA012	730,00 €	● F026S3EA012	730,00 €	● F026S4EA012	730,00 €
● F026S2EA018	730,00 €	● F026S3EA018	730,00 €	● F026S4EA018	730,00 €
● F026S2EA030	730,00 €	● F026S3EA030	730,00 €	● F026S4EA030	730,00 €
● F026S2EA033	730,00 €	● F026S3EA033	730,00 €	● F026S4EA033	730,00 €
1-10V					
○ F026S2EB001	793,00 €	○ F026S3EB001	793,00 €	○ F026S4EB001	793,00 €
● F026S2EB006	793,00 €	● F026S3EB006	793,00 €	● F026S4EB006	793,00 €
● F026S2EB012	793,00 €	● F026S3EB012	793,00 €	● F026S4EB012	793,00 €
● F026S2EB018	793,00 €	● F026S3EB018	793,00 €	● F026S4EB018	793,00 €
● F026S2EB030	793,00 €	● F026S3EB030	793,00 €	● F026S4EB030	793,00 €
● F026S2EB033	793,00 €	● F026S3EB033	793,00 €	● F026S4EB033	793,00 €
Dali					
○ F026S2ED001	793,00 €	○ F026S3ED001	793,00 €	○ F026S4ED001	793,00 €
● F026S2ED006	793,00 €	● F026S3ED006	793,00 €	● F026S4ED006	793,00 €
● F026S2ED012	793,00 €	● F026S3ED012	793,00 €	● F026S4ED012	793,00 €
● F026S2ED018	793,00 €	● F026S3ED018	793,00 €	● F026S4ED018	793,00 €
● F026S2ED030	793,00 €	● F026S3ED030	793,00 €	● F026S4ED030	793,00 €
● F026S2ED033	793,00 €	● F026S3ED033	793,00 €	● F026S4ED033	793,00 €

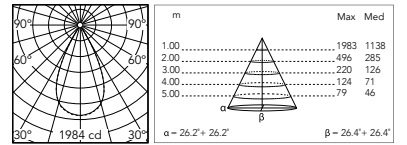

@ 3000K

Optic Elliptical 1 14° x 50°

Power Led: 17W - 1739 lm ≠ FIXT 1315 lm - 2700K/CRI 80 - 220-240V / 17W - 1803 lm ≠ FIXT 1364 lm - 3000K/CRI 80 - 220-240V / 17W - 1868 lm ≠ FIXT 1410 lm - 4000K/CRI 80 - 220-240V

2700K		3000K		4000K	
Non Dimmable		Non Dimmable		Non Dimmable	
○ F026S2FA001	730,00 €	○ F026S3FA001	730,00 €	○ F026S4FA001	730,00 €
● F026S2FA006	730,00 €	● F026S3FA006	730,00 €	● F026S4FA006	730,00 €
● F026S2FA012	730,00 €	● F026S3FA012	730,00 €	● F026S4FA012	730,00 €
● F026S2FA018	730,00 €	● F026S3FA018	730,00 €	● F026S4FA018	730,00 €
● F026S2FA030	730,00 €	● F026S3FA030	730,00 €	● F026S4FA030	730,00 €
● F026S2FA033	730,00 €	● F026S3FA033	730,00 €	● F026S4FA033	730,00 €
1-10V					
○ F026S2FB001	793,00 €	○ F026S3FB001	793,00 €	○ F026S4FB001	793,00 €
● F026S2FB006	793,00 €	● F026S3FB006	793,00 €	● F026S4FB006	793,00 €
● F026S2FB012	793,00 €	● F026S3FB012	793,00 €	● F026S4FB012	793,00 €
● F026S2FB018	793,00 €	● F026S3FB018	793,00 €	● F026S4FB018	793,00 €
● F026S2FB030	793,00 €	● F026S3FB030	793,00 €	● F026S4FB030	793,00 €
● F026S2FB033	793,00 €	● F026S3FB033	793,00 €	● F026S4FB033	793,00 €
Dali					
○ F026S2FD001	793,00 €	○ F026S3FD001	793,00 €	○ F026S4FD001	793,00 €
● F026S2FD006	793,00 €	● F026S3FD006	793,00 €	● F026S4FD006	793,00 €
● F026S2FD012	793,00 €	● F026S3FD012	793,00 €	● F026S4FD012	793,00 €
● F026S2FD018	793,00 €	● F026S3FD018	793,00 €	● F026S4FD018	793,00 €
● F026S2FD030	793,00 €	● F026S3FD030	793,00 €	● F026S4FD030	793,00 €
● F026S2FD033	793,00 €	● F026S3FD033	793,00 €	● F026S4FD033	793,00 €

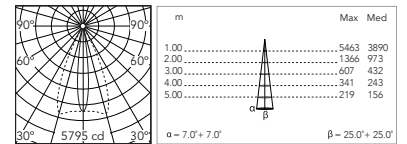

@ 3000K

Spine L 2 Ultra Hp

Optic Elliptical 2 25° x 52°

Power Led: 17W - 1739 lm ≠ FIXT 1298 lm - 2700K/CRI 80 - 220-240V / 17W - 1803 lm ≠ FIXT 1351 lm - 3000K/CRI 80 - 220-240V / 17W - 1868 lm ≠ FIXT 1393 lm - 4000K/CRI 80 - 220-240V

2700K

Non Dimmable

- F026S2GA001 730,00 €
- F026S2GA006 730,00 €
- F026S2GA012 730,00 €
- F026S2GA018 730,00 €
- F026S2GA030 730,00 €
- F026S2GA033 730,00 €

1-10V

- F026S2GB001 793,00 €
- F026S2GB006 793,00 €
- F026S2GB012 793,00 €
- F026S2GB018 793,00 €
- F026S2GB030 793,00 €
- F026S2GB033 793,00 €

Dali

- F026S2GD001 793,00 €
- F026S2GD006 793,00 €
- F026S2GD012 793,00 €
- F026S2GD018 793,00 €
- F026S2GD030 793,00 €
- F026S2GD033 793,00 €

3000K

Non Dimmable

- F026S3GA001 730,00 €
- F026S3GA006 730,00 €
- F026S3GA012 730,00 €
- F026S3GA018 730,00 €
- F026S3GA030 730,00 €
- F026S3GA033 730,00 €

1-10V

- F026S3GB001 793,00 €
- F026S3GB006 793,00 €
- F026S3GB012 793,00 €
- F026S3GB018 793,00 €
- F026S3GB030 793,00 €
- F026S3GB033 793,00 €

Dali

- F026S3GD001 793,00 €
- F026S3GD006 793,00 €
- F026S3GD012 793,00 €
- F026S3GD018 793,00 €
- F026S3GD030 793,00 €
- F026S3GD033 793,00 €

4000K

Non Dimmable

- F026S4GA001 730,00 €
- F026S4GA006 730,00 €
- F026S4GA012 730,00 €
- F026S4GA018 730,00 €
- F026S4GA030 730,00 €
- F026S4GA033 730,00 €

1-10V

- F026S4GB001 793,00 €
- F026S4GB006 793,00 €
- F026S4GB012 793,00 €
- F026S4GB018 793,00 €
- F026S4GB030 793,00 €
- F026S4GB033 793,00 €

Dali

- F026S4GD001 793,00 €
- F026S4GD006 793,00 €
- F026S4GD012 793,00 €
- F026S4GD018 793,00 €
- F026S4GD030 793,00 €
- F026S4GD033 793,00 €

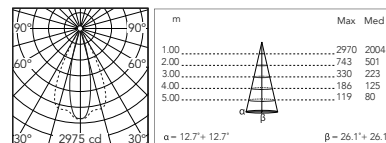

@ 3000K

Optic Wall Washer

Power Led: 17W - 1739 lm ≠ FIXT 1277 lm - 2700K/CRI 80 - 220-240V / 17W - 1803 lm ≠ FIXT 1325 lm - 3000K/CRI 80 - 220-240V / 17W - 1868 lm ≠ FIXT 1370 lm - 4000K/CRI 80 - 220-240V

2700K

Non Dimmable

- F026S2HA001 730,00 €
- F026S2HA006 730,00 €
- F026S2HA012 730,00 €
- F026S2HA018 730,00 €
- F026S2HA030 730,00 €
- F026S2HA033 730,00 €

1-10V

- F026S2HB001 793,00 €
- F026S2HB006 793,00 €
- F026S2HB012 793,00 €
- F026S2HB018 793,00 €
- F026S2HB030 793,00 €
- F026S2HB033 793,00 €

Dali

- F026S2HD001 793,00 €
- F026S2HD006 793,00 €
- F026S2HD012 793,00 €
- F026S2HD018 793,00 €
- F026S2HD030 793,00 €
- F026S2HD033 793,00 €

3000K

Non Dimmable

- F026S3HA001 730,00 €
- F026S3HA006 730,00 €
- F026S3HA012 730,00 €
- F026S3HA018 730,00 €
- F026S3HA030 730,00 €
- F026S3HA033 730,00 €

1-10V

- F026S3HB001 793,00 €
- F026S3HB006 793,00 €
- F026S3HB012 793,00 €
- F026S3HB018 793,00 €
- F026S3HB030 793,00 €
- F026S3HB033 793,00 €

Dali

- F026S3HD001 793,00 €
- F026S3HD006 793,00 €
- F026S3HD012 793,00 €
- F026S3HD018 793,00 €
- F026S3HD030 793,00 €
- F026S3HD033 793,00 €

4000K

Non Dimmable

- F026S4HA001 730,00 €
- F026S4HA006 730,00 €
- F026S4HA012 730,00 €
- F026S4HA018 730,00 €
- F026S4HA030 730,00 €
- F026S4HA033 730,00 €

1-10V

- F026S4HB001 793,00 €
- F026S4HB006 793,00 €
- F026S4HB012 793,00 €
- F026S4HB018 793,00 €
- F026S4HB030 793,00 €
- F026S4HB033 793,00 €



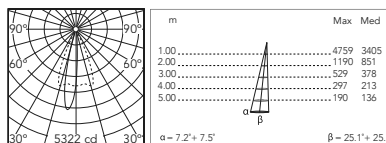

Dali

- F026S4HD001 793,00 €
- F026S4HD006 793,00 €
- F026S4HD012 793,00 €
- F026S4HD018 793,00 €
- F026S4HD030 793,00 €
- F026S4HD033 793,00 €

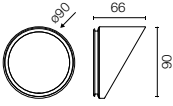

@ 3000K

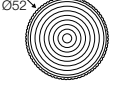
Spine L 2 Ultra: Accessoires / Accessories

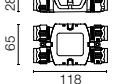
Viseur	Visor	<ul style="list-style-type: none"> ○ F026Z050001 ● F026Z050006 ● F026Z050012 ● F026Z050018 ● F026Z050030 ● F026Z050033 	57,00 € 57,00 € 57,00 € 57,00 € 57,00 € 57,00 €		
Honeycomb	Honeycomb Louvre	F026Z060000	21,00 €		
Gelbox IPX8 pour le raccordement électrique.	Gelbox IPX8 for splicing connectors.	F990C110000	22,00 €		
Lentilles de conversion / Converter lenses:					
- Converter Spine 2 Optic Medium Flood		F029Z020000	37,00 €		
- Converter Spine 2 Optic Flood		F029Z021000	37,00 €		
- Converter Spine 2 Optic Wide Flood		F029Z022000	37,00 €		
- Converter Spine 2 Optic Elliptic 1		F029Z023000	37,00 €		
- Converter Spine 2 Optic Elliptic 2		F029Z024000	37,00 €		
- Converter Spine 2 Optic Wall Washer		F029Z025000	37,00 €		
Système de jonction IP68 H2O Stop anti-condensation à 2 voies 4 pôles.	2 way terminal block 4 poles IP68 H2O Stop.	F990C00A000	33,00 €		
Système de jonction IP68 H2O Stop anti-condensation à 3/4 voies 4 pôles. (Ø5,5÷12mm câble).	3/4 way terminal block 4 poles IP68 H2O Stop. (ø5,5÷12mm cable).	F990C010000	60,00 €		
Kit de connecteurs à 5 pôles: fiche volante + fiche EU IP68.	Connector kit 5-pole flying socket + EU plug IP68.	F990C080000	48,00 €		
Boitier de dérivation 5 pôles 4 voies (câbles 6-14 mm).	4 way junction box 5 poles IP68 (6-14 mm cables).	F990C030000	62,00 €		

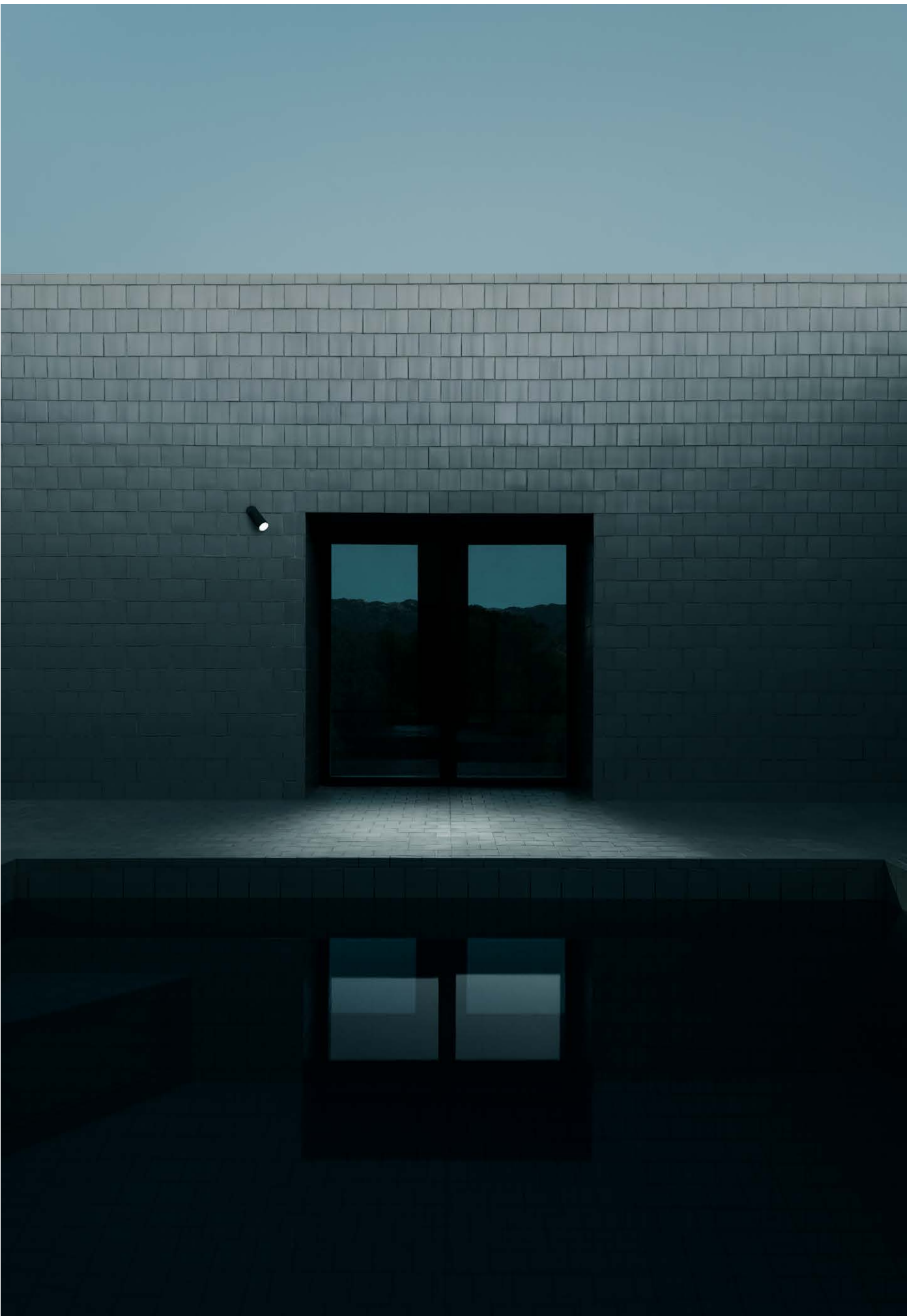

Spine T

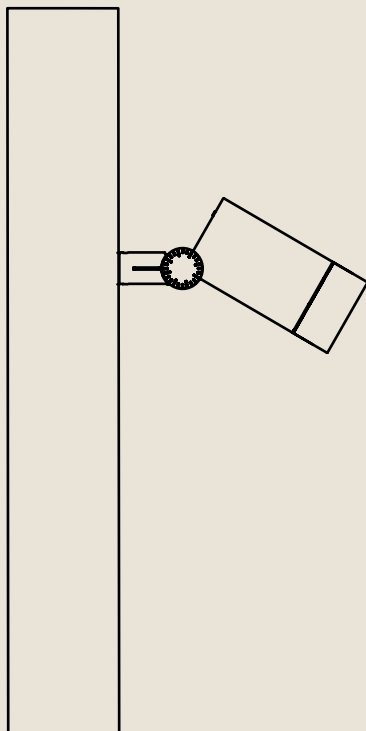

Une connexion spéciale a été conçue pour l'installation du produit sur des mâts pour la gestion de scènes de lumière complexes et la combinaison de plusieurs projecteurs sur une seule colonne.

A special pole connection has been designed for product installation on poles to manage complex light scenes and mix multiple projectors in one single column.

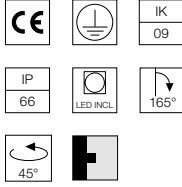
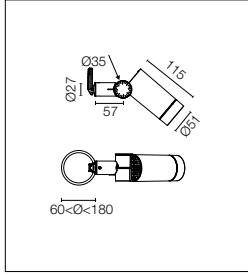

Source Power LED incluse. Équipée d'un snoot intégré pour un plus grand confort visuel. Les collimateurs sont des accessoires disponibles pour modifier la largeur du faisceau lumineux. Source d'alimentation électrique intégrée 220-240V ON/OFF. Support pour fixation sur poteau intégré, pour des poteaux de 60 à 120 mm de diamètre et 3 mm d'épaisseur maximum. Équipée d'un câble en néoprène de 5m (10m sur commande) pour une connexion à distance; pour garantir l'étanchéité, il est conseillé d'utiliser des câbles flexibles conçus pour l'extérieur.

Power LED source included. Equipped with an integrated snoot for higher visual comfort. Collimators are available as an accessory to modify the beam opening. Integrated electric power supply 220-240V ON/OFF. Integrated support for pole fixing, for poles with a diameter between 60 and 120 mm and a maximum thickness of 3 mm. Equipped with a 5m neoprene cable (10m upon request) for remote connection. To guarantee its water tightness, it is recommended to use flexible cables designed for outdoor use.

2200K disponible sur demande.

2200K available on request.

Version dimmable DALI disponible sur demande.

DALI dimmable version available on request.

Optic Spot 14°

Power Led: 5W - 481 lm ≠ FIXT 368 lm - 2700K/CRI 80 - 220-240V / 5W - 493 lm ≠ FIXT 377 lm - 3000K/CRI 80 - 220-240V / 5W - 540 lm ≠ FIXT 413 lm - 4000K/CRI 80 - 220-240V

2700K

Non Dimmable

○ F02752BA001	329,00 €
● F02752BA006	329,00 €
● F02752BA012	329,00 €
● F02752BA018	329,00 €
● F02752BA030	329,00 €
● F02752BA033	329,00 €

3000K

Non Dimmable

○ F02753BA001	329,00 €
● F02753BA006	329,00 €
● F02753BA012	329,00 €
● F02753BA018	329,00 €
● F02753BA030	329,00 €
● F02753BA033	329,00 €

4000K

Non Dimmable

○ F02754BA001	329,00 €
● F02754BA006	329,00 €
● F02754BA012	329,00 €
● F02754BA018	329,00 €
● F02754BA030	329,00 €
● F02754BA033	329,00 €

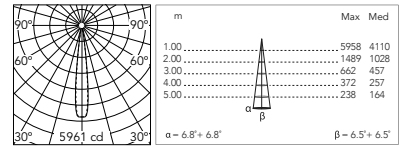

@ 3000K

Optic Medium Flood 26°

Power Led: 5W - 481 lm ≠ FIXT 337 lm - 2700K/CRI 80 - 220-240V / 5W - 493 lm ≠ FIXT 346 lm - 3000K/CRI 80 - 220-240V / 5W - 540 lm ≠ FIXT 378 lm - 4000K/CRI 80 - 220-240V

2700K

Non Dimmable

○ F02752CA001	329,00 €
● F02752CA006	329,00 €
● F02752CA012	329,00 €
● F02752CA018	329,00 €
● F02752CA030	329,00 €
● F02752CA033	329,00 €

3000K

Non Dimmable

○ F02753CA001	329,00 €
● F02753CA006	329,00 €
● F02753CA012	329,00 €
● F02753CA018	329,00 €
● F02753CA030	329,00 €
● F02753CA033	329,00 €

4000K

Non Dimmable

○ F02754CA001	329,00 €
● F02754CA006	329,00 €
● F02754CA012	329,00 €
● F02754CA018	329,00 €
● F02754CA030	329,00 €
● F02754CA033	329,00 €

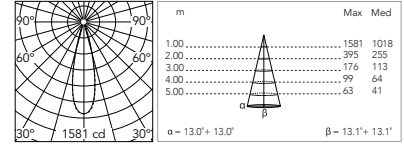

@ 3000K

Optic Flood 36°

Power Led: 5W - 481 lm ≠ FIXT 332 lm - 2700K/CRI 80 - 220-240V / 5W - 493 lm ≠ FIXT 340 lm - 3000K/CRI 80 - 220-240V / 5W - 540 lm ≠ FIXT 373 lm - 4000K/CRI 80 - 220-240V

2700K

Non Dimmable

○ F02752DA001	329,00 €
● F02752DA006	329,00 €
● F02752DA012	329,00 €
● F02752DA018	329,00 €
● F02752DA030	329,00 €
● F02752DA033	329,00 €

3000K

Non Dimmable

○ F02753DA001	329,00 €
● F02753DA006	329,00 €
● F02753DA012	329,00 €
● F02753DA018	329,00 €
● F02753DA030	329,00 €
● F02753DA033	329,00 €

4000K

Non Dimmable

○ F02754DA001	329,00 €
● F02754DA006	329,00 €
● F02754DA012	329,00 €
● F02754DA018	329,00 €
● F02754DA030	329,00 €
● F02754DA033	329,00 €

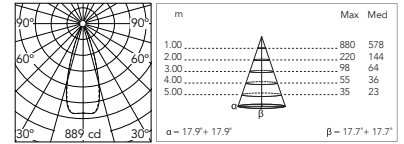

@ 3000K

Optic Wide Flood 50°

Power Led: 5W - 481 lm ≠ FIXT 324 lm - 2700K/CRI 80 - 220-240V / 5W - 493 lm ≠ FIXT 332 lm - 3000K/CRI 80 - 220-240V / 5W - 540 lm ≠ FIXT 363 lm - 4000K/CRI 80 - 220-240V

2700K

Non Dimmable

○ F02752EA001	329,00 €
● F02752EA006	329,00 €
● F02752EA012	329,00 €
● F02752EA018	329,00 €
● F02752EA030	329,00 €
● F02752EA033	329,00 €

3000K

Non Dimmable

○ F02753EA001	329,00 €
● F02753EA006	329,00 €
● F02753EA012	329,00 €
● F02753EA018	329,00 €
● F02753EA030	329,00 €
● F02753EA033	329,00 €

4000K

Non Dimmable

○ F02754EA001	329,00 €
● F02754EA006	329,00 €
● F02754EA012	329,00 €
● F02754EA018	329,00 €
● F02754EA030	329,00 €
● F02754EA033	329,00 €

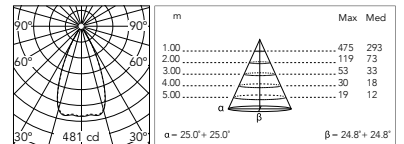

@ 3000K

Optic Elliptical 1 12° x 50°

Power Led: 5W - 481 lm ≠ FIXT 342 lm - 2700K/CRI 80 - 220-240V / 5W - 493 lm ≠ FIXT 350 lm - 3000K/CRI 80 - 220-240V / 5W - 540 lm ≠ FIXT 383 lm - 4000K/CRI 80 - 220-240V

2700K Non Dimmable		3000K Non Dimmable		4000K Non Dimmable	
○ F02752FA001	329,00 €	○ F02753FA001	329,00 €	○ F02754FA001	329,00 €
● F02752FA006	329,00 €	● F02753FA006	329,00 €	● F02754FA006	329,00 €
● F02752FA012	329,00 €	● F02753FA012	329,00 €	● F02754FA012	329,00 €
● F02752FA018	329,00 €	● F02753FA018	329,00 €	● F02754FA018	329,00 €
● F02752FA030	329,00 €	● F02753FA030	329,00 €	● F02754FA030	329,00 €
● F02752FA033	329,00 €	● F02753FA033	329,00 €	● F02754FA033	329,00 €

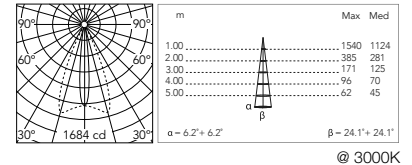

Optic Elliptical 2 26° x 51°

Power Led: 5W - 481 lm ≠ FIXT 334 lm - 2700K/CRI 80 - 220-240V / 5W - 493 lm ≠ FIXT 342 lm - 3000K/CRI 80 - 220-240V / 5W - 540 lm ≠ FIXT 375 lm - 4000K/CRI 80 - 220-240V

2700K Non Dimmable		3000K Non Dimmable		4000K Non Dimmable	
○ F02752GA001	329,00 €	○ F02753GA001	329,00 €	○ F02754GA001	329,00 €
● F02752GA006	329,00 €	● F02753GA006	329,00 €	● F02754GA006	329,00 €
● F02752GA012	329,00 €	● F02753GA012	329,00 €	● F02754GA012	329,00 €
● F02752GA018	329,00 €	● F02753GA018	329,00 €	● F02754GA018	329,00 €
● F02752GA030	329,00 €	● F02753GA030	329,00 €	● F02754GA030	329,00 €
● F02752GA033	329,00 €	● F02753GA033	329,00 €	● F02754GA033	329,00 €

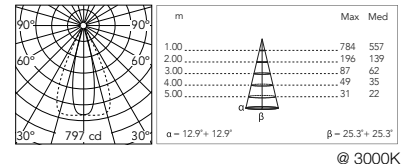

Optic Wall Washer

Power Led: 5W - 481 lm ≠ FIXT 321 lm - 2700K/CRI 80 - 220-240V / 5W - 493 lm ≠ FIXT 329 lm - 3000K/CRI 80 - 220-240V / 5W - 540 lm ≠ FIXT 360 lm - 4000K/CRI 80 - 220-240V

2700K Non Dimmable		3000K Non Dimmable		4000K Non Dimmable	
○ F02752HA001	329,00 €	○ F02753HA001	329,00 €	○ F02754HA001	329,00 €
● F02752HA006	329,00 €	● F02753HA006	329,00 €	● F02754HA006	329,00 €
● F02752HA012	329,00 €	● F02753HA012	329,00 €	● F02754HA012	329,00 €
● F02752HA018	329,00 €	● F02753HA018	329,00 €	● F02754HA018	329,00 €
● F02752HA030	329,00 €	● F02753HA030	329,00 €	● F02754HA030	329,00 €
● F02752HA033	329,00 €	● F02753HA033	329,00 €	● F02754HA033	329,00 €

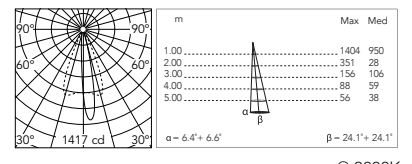

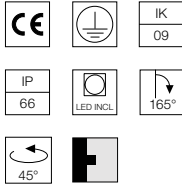
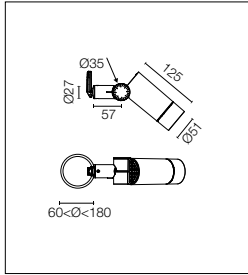

Source Power LED incluse. Équipée d'un snoot intégré pour un plus grand confort visuel. Les collimateurs sont des accessoires disponibles pour modifier la largeur du faisceau lumineux. Source d'alimentation électrique intégrée 220-240V ON/OFF. Support pour fixation sur poteau intégré, pour des poteaux de 60 à 120 mm de diamètre et 3 mm d'épaisseur maximum. Équipée d'un câble en néoprène de 5m (10m sur commande) pour une connexion à distance; pour garantir l'étanchéité, il est conseillé d'utiliser des câbles flexibles conçus pour l'extérieur.

Power LED source included. Equipped with an integrated snoot for higher visual comfort. Collimators are available as an accessory to modify the beam opening. Integrated electric power supply 220-240V ON/OFF. Integrated support for pole fixing, for poles with a diameter between 60 and 120 mm and a maximum thickness of 3 mm. Equipped with a 5m neoprene cable (10m upon request) for remote connection. To guarantee its water tightness, it is recommended to use flexible cables designed for outdoor use.

2200K disponible sur demande.

2200K available on request.

Version dimmable DALI disponible sur demande.

DALI dimmable version available on request.

Optic Spot 14°

Power Led: 5W - 481 lm ≠ FIXT 368 lm - 2700K/CRI 80 - 220-240V / 5W - 493 lm ≠ FIXT 377 lm - 3000K/CRI 80 - 220-240V / 5W - 540 lm ≠ FIXT 413 lm - 4000K/CRI 80 - 220-240V

2700K

Non Dimmable

○ F02712BA001	366,00 €
● F02712BA006	366,00 €
● F02712BA012	366,00 €
● F02712BA018	366,00 €
● F02712BA030	366,00 €
● F02712BA033	366,00 €

3000K

Non Dimmable

○ F02713BA001	366,00 €
● F02713BA006	366,00 €
● F02713BA012	366,00 €
● F02713BA018	366,00 €
● F02713BA030	366,00 €
● F02713BA033	366,00 €

4000K

Non Dimmable

○ F02714BA001	366,00 €
● F02714BA006	366,00 €
● F02714BA012	366,00 €
● F02714BA018	366,00 €
● F02714BA030	366,00 €
● F02714BA033	366,00 €

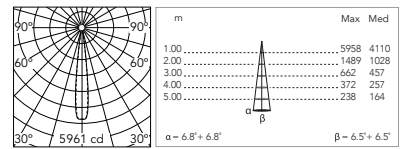

@ 3000K

Optic Medium Flood 26°

Power Led: 5W - 481 lm ≠ FIXT 337 lm - 2700K/CRI 80 - 220-240V / 5W - 493 lm ≠ FIXT 346 lm - 3000K/CRI 80 - 220-240V / 5W - 540 lm ≠ FIXT 378 lm - 4000K/CRI 80 - 220-240V

2700K

Non Dimmable

○ F02712CA001	366,00 €
● F02712CA006	366,00 €
● F02712CA012	366,00 €
● F02712CA018	366,00 €
● F02712CA030	366,00 €
● F02712CA033	366,00 €

3000K

Non Dimmable

○ F02713CA001	366,00 €
● F02713CA006	366,00 €
● F02713CA012	366,00 €
● F02713CA018	366,00 €
● F02713CA030	366,00 €
● F02713CA033	366,00 €

4000K

Non Dimmable

○ F02714CA001	366,00 €
● F02714CA006	366,00 €
● F02714CA012	366,00 €
● F02714CA018	366,00 €
● F02714CA030	366,00 €
● F02714CA033	366,00 €

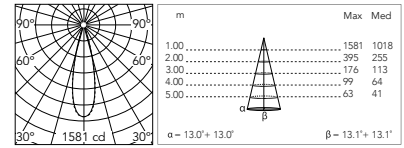

@ 3000K

Optic Flood 36°

Power Led: 5W - 481 lm ≠ FIXT 332 lm - 2700K/CRI 80 - 220-240V / 5W - 493 lm ≠ FIXT 340 lm - 3000K/CRI 80 - 220-240V / 5W - 540 lm ≠ FIXT 373 lm - 4000K/CRI 80 - 220-240V

2700K

Non Dimmable

○ F02712DA001	366,00 €
● F02712DA006	366,00 €
● F02712DA012	366,00 €
● F02712DA018	366,00 €
● F02712DA030	366,00 €
● F02712DA033	366,00 €

3000K

Non Dimmable

○ F02713DA001	366,00 €
● F02713DA006	366,00 €
● F02713DA012	366,00 €
● F02713DA018	366,00 €
● F02713DA030	366,00 €
● F02713DA033	366,00 €

4000K

Non Dimmable

○ F02714DA001	366,00 €
● F02714DA006	366,00 €
● F02714DA012	366,00 €
● F02714DA018	366,00 €
● F02714DA030	366,00 €
● F02714DA033	366,00 €

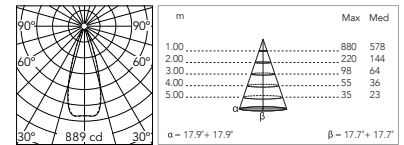

@ 3000K

Optic Wide Flood 50°

Power Led: 5W - 481 lm ≠ FIXT 324 lm - 2700K/CRI 80 - 220-240V / 5W - 493 lm ≠ FIXT 332 lm - 3000K/CRI 80 - 220-240V / 5W - 540 lm ≠ FIXT 363 lm - 4000K/CRI 80 - 220-240V

2700K

Non Dimmable

○ F02712EA001	366,00 €
● F02712EA006	366,00 €
● F02712EA012	366,00 €
● F02712EA018	366,00 €
● F02712EA030	366,00 €
● F02712EA033	366,00 €

3000K

Non Dimmable

○ F02713EA001	366,00 €
● F02713EA006	366,00 €
● F02713EA012	366,00 €
● F02713EA018	366,00 €
● F02713EA030	366,00 €
● F02713EA033	366,00 €

4000K

Non Dimmable

○ F02714EA001	366,00 €
● F02714EA006	366,00 €
● F02714EA012	366,00 €
● F02714EA018	366,00 €
● F02714EA030	366,00 €
● F02714EA033	366,00 €

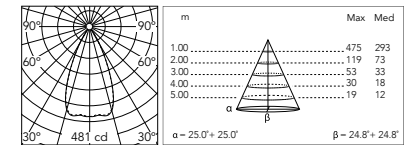

@ 3000K

Spine T 0 Ultra

Optic Elliptical 1 12° x 50°

Power Led: 5W - 481 lm ≠ FIXT 342 lm - 2700K/CRI 80 - 220-240V / 5W - 493 lm ≠ FIXT 350 lm - 3000K/CRI 80 - 220-240V / 5W - 540 lm ≠ FIXT 383 lm - 4000K/CRI 80 - 220-240V

2700K

Non Dimmable

○ F02712FA001	366,00 €
● F02712FA006	366,00 €
● F02712FA012	366,00 €
● F02712FA018	366,00 €
● F02712FA030	366,00 €
● F02712FA033	366,00 €

3000K

Non Dimmable

○ F02713FA001	366,00 €
● F02713FA006	366,00 €
● F02713FA012	366,00 €
● F02713FA018	366,00 €
● F02713FA030	366,00 €
● F02713FA033	366,00 €

4000K

Non Dimmable

○ F02714FA001	366,00 €
● F02714FA006	366,00 €
● F02714FA012	366,00 €
● F02714FA018	366,00 €
● F02714FA030	366,00 €
● F02714FA033	366,00 €

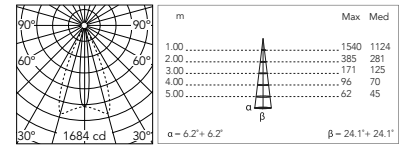

@ 3000K

Optic Elliptical 2 26° x 51°

Power Led: 5W - 481 lm ≠ FIXT 334 lm - 2700K/CRI 80 - 220-240V / 5W - 493 lm ≠ FIXT 342 lm - 3000K/CRI 80 - 220-240V / 5W - 540 lm ≠ FIXT 375 lm - 4000K/CRI 80 - 220-240V

2700K

Non Dimmable

○ F02712GA001	366,00 €
● F02712GA006	366,00 €
● F02712GA012	366,00 €
● F02712GA018	366,00 €
● F02712GA030	366,00 €
● F02712GA033	366,00 €

3000K

Non Dimmable

○ F02713GA001	366,00 €
● F02713GA006	366,00 €
● F02713GA012	366,00 €
● F02713GA018	366,00 €
● F02713GA030	366,00 €
● F02713GA033	366,00 €

4000K

Non Dimmable

○ F02714GA001	366,00 €
● F02714GA006	366,00 €
● F02714GA012	366,00 €
● F02714GA018	366,00 €
● F02714GA030	366,00 €
● F02714GA033	366,00 €

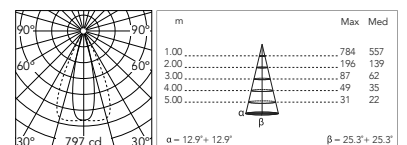

@ 3000K

Optic Wall Washer

Power Led: 5W - 481 lm ≠ FIXT 321 lm - 2700K/CRI 80 - 220-240V / 5W - 493 lm ≠ FIXT 329 lm - 3000K/CRI 80 - 220-240V / 5W - 540 lm ≠ FIXT 360 lm - 4000K/CRI 80 - 220-240V

2700K

Non Dimmable

○ F02712HA001	366,00 €
● F02712HA006	366,00 €
● F02712HA012	366,00 €
● F02712HA018	366,00 €
● F02712HA030	366,00 €
● F02712HA033	366,00 €

3000K

Non Dimmable

○ F02713HA001	366,00 €
● F02713HA006	366,00 €
● F02713HA012	366,00 €
● F02713HA018	366,00 €
● F02713HA030	366,00 €
● F02713HA033	366,00 €

4000K





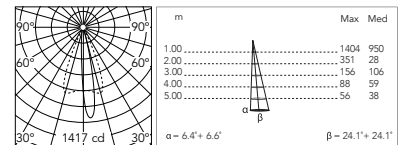



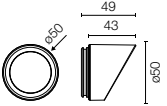

Non Dimmable

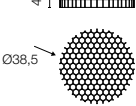
○ F02714HA001	366,00 €
● F02714HA006	366,00 €
● F02714HA012	366,00 €
● F02714HA018	366,00 €
● F02714HA030	366,00 €
● F02714HA033	366,00 €

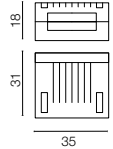

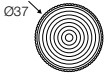
@ 3000K

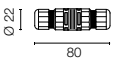
Spine T 0 Ultra: Accessoires / Accessories

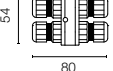
Visor	Visor	<ul style="list-style-type: none"> ○ F027Z050001 47,00 € ● F027Z050006 47,00 € ● F027Z050012 47,00 € ● F027Z050018 47,00 € ● F027Z050030 47,00 € ● F027Z050033 47,00 € 	 	
Honeycomb	Honeycomb Louvre	F027Z060000	17,00 €	 
Gelbox IPX8 pour le raccordement électrique.	Gelbox IPX8 for splicing connectors.	F990C100000	14,00 €	 
Lentilles de conversion / Converter lenses: <ul style="list-style-type: none"> - Converter Spine 0 / Spine 1 Optic Medium Flood - Converter Spine 0 / Spine 1 Optic Flood - Converter Spine 0 / Spine 1 Optic Wide Flood - Converter Spine 0 / Spine 1 Optic Elliptic 1 - Converter Spine 0 / Spine 1 Optic Elliptic 2 - Converter Spine 0 / Spine 1 Optic Wall Washer 		<ul style="list-style-type: none"> F029Z010000 35,00 € F029Z011000 35,00 € F029Z012000 35,00 € F029Z013000 35,00 € F029Z014000 35,00 € F029Z015000 35,00 € 	 	
Système de jonction IP68 H2O Stop anti-condensation à 2 voies 4 pôles.	2 way terminal block 4 poles IP68 H2O Stop.	F990C00A000	33,00 €	 
Système de jonction IP68 H2O Stop anti-condensation à 3/4 voies 4 pôles. (Ø5,5÷12mm câble).	3/4 way terminal block 4 poles IP68 H2O Stop. (Ø5,5÷12mm cable).	F990C010000	60,00 €	 



Spine T 1 Absolute

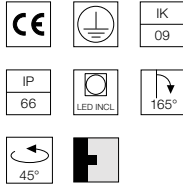
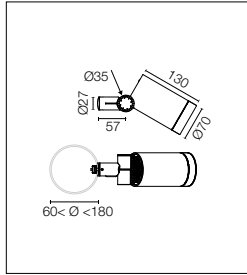

Source LED COB intégrée.
Source d'alimentation électrique intégrée 220-240V ON/OFF.
Support pour fixation sur poteau intégré, pour des poteaux de 60 à 120 mm de diamètre et 3 mm d'épaisseur maximum. Équipée d'un câble en néoprène de 5m (10m sur commande) pour une connexion à distance; pour garantir l'étanchéité, il est conseillé d'utiliser des câbles flexibles conçus pour l'extérieur.
Sur commande, version réglable 1-10V ou DALI avec source d'alimentation à distance 24Vdc.

LED COB light source integrated.
Integrated electric power supply 220-240V ON/OFF. Integrated support for pole fixing, for poles with a diameter between 60 and 120 mm and a maximum thickness of 3 mm. Equipped with a 5m neoprene cable (10m upon request) for remote connection. To guarantee its water tightness, it is recommended to use flexible cables designed for outdoor use. Upon request: 1-10V or DALI dimmable version with 24Vdc remote power supply.

Optic Spot 15°

CoB Led: 11W - 1247 lm ≠ FIXT 923 lm - 2700K/CRI 80 - 220-240V / 11W - 1325 lm ≠ FIXT 982 lm - 3000K/CRI 80 - 220-240V / 11W - 1364 lm ≠ FIXT 1011 lm - 4000K/CRI 80 - 220-240V

2700K

Non Dimmable

- F02502BA001 381,00 €
- F02502BA006 381,00 €
- F02502BA012 381,00 €
- F02502BA018 381,00 €
- F02502BA030 381,00 €
- F02502BA033 381,00 €

3000K

Non Dimmable

- F02503BA001 381,00 €
- F02503BA006 381,00 €
- F02503BA012 381,00 €
- F02503BA018 381,00 €
- F02503BA030 381,00 €
- F02503BA033 381,00 €

4000K

Non Dimmable

- F02504BA001 381,00 €
- F02504BA006 381,00 €
- F02504BA012 381,00 €
- F02504BA018 381,00 €
- F02504BA030 381,00 €
- F02504BA033 381,00 €

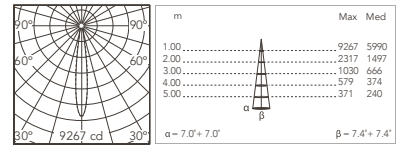

@ 3000K

Optic Medium Flood 33°

CoB Led: 11W - 1247 lm ≠ FIXT 906 lm - 2700K/CRI 80 - 220-240V / 11W - 1325 lm ≠ FIXT 964 lm - 3000K/CRI 80 - 220-240V / 11W - 1364 lm ≠ FIXT 993 lm - 4000K/CRI 80 - 220-240V

2700K

Non Dimmable

- F02502CA001 381,00 €
- F02502CA006 381,00 €
- F02502CA012 381,00 €
- F02502CA018 381,00 €
- F02502CA030 381,00 €
- F02502CA033 381,00 €

3000K

Non Dimmable

- F02503CA001 381,00 €
- F02503CA006 381,00 €
- F02503CA012 381,00 €
- F02503CA018 381,00 €
- F02503CA030 381,00 €
- F02503CA033 381,00 €

4000K

Non Dimmable

- F02504CA001 381,00 €
- F02504CA006 381,00 €
- F02504CA012 381,00 €
- F02504CA018 381,00 €
- F02504CA030 381,00 €
- F02504CA033 381,00 €

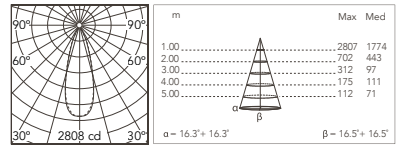

@ 3000K

Spine T 1 / T 2 Absolute: Accessoires / Accessories

Honeycomb	Honeycomb Louvre	Spine T 1 F025Z060000	20,00 €		
Honeycomb	Honeycomb Louvre	Spine T 2 F026Z060000	21,00 €		
Gelbox IPX8 pour le raccordement électrique.	Gelbox IPX8 for splicing connectors.	Spine T 1 F990C100000	14,00 €		
Gelbox IPX8 pour le raccordement électrique.	Gelbox IPX8 for splicing connectors.	Spine T 2 F990C110000	22,00 €		

Spine T 1 / T 2 Absolute: Accessoires pour les versions non dimmables / Accessories for non-dimmable versions

Système de jonction IP68 H2O Stop anti-condensation à 2 voies 4 pôles.	2 way terminal block 4 poles IP68 H2O Stop.	F990C00A000	33,00 €		
Système de jonction IP68 H2O Stop anti-condensation à 3/4 voies 4 pôles. (Ø5,5÷12mm câble).	3/4 way terminal block 4 poles IP68 H2O Stop. (Ø5,5÷12mm câble).	F990C010000	60,00 €		

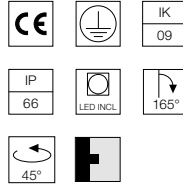
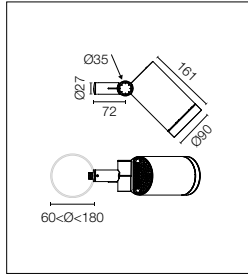

Source LED COB intégrée.
Source d'alimentation électrique intégrée 220-240V ON/OFF et réglable 1-10V ou DALI. Support pour fixation sur poteau intégré, pour des poteaux de 60 à 120 mm de diamètre et 3 mm d'épaisseur maximum. Équipée d'un câble en néoprène de 5m (10m sur commande) pour une connexion à distance ; pour garantir l'étanchéité, il est conseillé d'utiliser des câbles flexibles conçus pour l'extérieur.

LED COB light source integrated. Integrated electric power supply 220-240V ON/OFF and adjustable 1-10V or DALI. Integrated support for pole fixing, for poles with a diameter between 60 and 120 mm and a maximum thickness of 3 mm. Equipped with a 5m neoprene cable (10m upon request) for remote connection. To guarantee its watertightness, it is recommended to use flexible cables designed for outdoor use.

Optic Spot 22°

CoB Led: 19,5W - 2197 lm ≠ FIXT 1939 lm - 2700K/CRI 80 - 220-240V / 19,5W - 2367 lm ≠ FIXT 2085 lm - 3000K/CRI 80 - 220-240V / 19,5W - 2497 lm ≠ FIXT 2120 lm - 4000K/CRI 80 - 220-240V

2700K Non Dimmable		3000K Non Dimmable		4000K Non Dimmable	
○ F02602BA001.A	512,00 €	○ F02603BA001	512,00 €	○ F02604BA001.A	512,00 €
● F02602BA006.A	512,00 €	● F02603BA006	512,00 €	● F02604BA006.A	512,00 €
● F02602BA012.A	512,00 €	● F02603BA012	512,00 €	● F02604BA012.A	512,00 €
● F02602BA018.A	512,00 €	● F02603BA018	512,00 €	● F02604BA018.A	512,00 €
● F02602BA030.A	512,00 €	● F02603BA030	512,00 €	● F02604BA030.A	512,00 €
● F02602BA033.A	512,00 €	● F02603BA033	512,00 €	● F02604BA033.A	512,00 €
1-10V		1-10V		1-10V	
○ F02602BB001.A	554,00 €	○ F02603BB001	554,00 €	○ F02604BB001.A	554,00 €
● F02602BB006.A	554,00 €	● F02603BB006	554,00 €	● F02604BB006.A	554,00 €
● F02602BB012.A	554,00 €	● F02603BB012	554,00 €	● F02604BB012.A	554,00 €
● F02602BB018.A	554,00 €	● F02603BB018	554,00 €	● F02604BB018.A	554,00 €
● F02602BB030.A	554,00 €	● F02603BB030	554,00 €	● F02604BB030.A	554,00 €
● F02602BB033.A	554,00 €	● F02603BB033	554,00 €	● F02604BB033.A	554,00 €
Dali		Dali		Dali	
○ F02602BD001.A	554,00 €	○ F02603BD001	554,00 €	○ F02604BD001.A	554,00 €
● F02602BD006.A	554,00 €	● F02603BD006	554,00 €	● F02604BD006.A	554,00 €
● F02602BD012.A	554,00 €	● F02603BD012	554,00 €	● F02604BD012.A	554,00 €
● F02602BD018.A	554,00 €	● F02603BD018	554,00 €	● F02604BD018.A	554,00 €
● F02602BD030.A	554,00 €	● F02603BD030	554,00 €	● F02604BD030.A	554,00 €
● F02602BD033.A	554,00 €	● F02603BD033	554,00 €	● F02604BD033.A	554,00 €

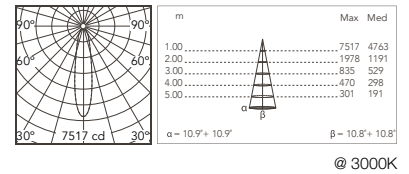

Optic Medium Flood 43°

CoB Led: 19,5W - 2197 lm ≠ FIXT 2026 lm - 2700K/CRI 80 - 220-240V / 19,5W - 2367 lm ≠ FIXT 2178 lm - 3000K/CRI 80 - 220-240V / 19,5W - 2497 lm ≠ FIXT 2298 lm - 4000K/CRI 80 - 220-240V

2700K Non Dimmable		3000K Non Dimmable		4000K Non Dimmable	
○ F02602CA001.A	512,00 €	○ F02603CA001	512,00 €	○ F02604CA001.A	512,00 €
● F02602CA006.A	512,00 €	● F02603CA006	512,00 €	● F02604CA006.A	512,00 €
● F02602CA012.A	512,00 €	● F02603CA012	512,00 €	● F02604CA012.A	512,00 €
● F02602CA018.A	512,00 €	● F02603CA018	512,00 €	● F02604CA018.A	512,00 €
● F02602CA030.A	512,00 €	● F02603CA030	512,00 €	● F02604CA030.A	512,00 €
● F02602CA033.A	512,00 €	● F02603CA033	512,00 €	● F02604CA033.A	512,00 €
1-10V		1-10V		1-10V	
○ F02602CB001.A	554,00 €	○ F02603CB001	554,00 €	○ F02604CB001.A	554,00 €
● F02602CB006.A	554,00 €	● F02603CB006	554,00 €	● F02604CB006.A	554,00 €
● F02602CB012.A	554,00 €	● F02603CB012	554,00 €	● F02604CB012.A	554,00 €
● F02602CB018.A	554,00 €	● F02603CB018	554,00 €	● F02604CB018.A	554,00 €
● F02602CB030.A	554,00 €	● F02603CB030	554,00 €	● F02604CB030.A	554,00 €
● F02602CB033.A	554,00 €	● F02603CB033	554,00 €	● F02604CB033.A	554,00 €
Dali		Dali		Dali	
○ F02602CD001.A	554,00 €	○ F02603CD001	554,00 €	○ F02604CD001.A	554,00 €
● F02602CD006.A	554,00 €	● F02603CD006	554,00 €	● F02604CD006.A	554,00 €
● F02602CD012.A	554,00 €	● F02603CD012	554,00 €	● F02604CD012.A	554,00 €
● F02602CD018.A	554,00 €	● F02603CD018	554,00 €	● F02604CD018.A	554,00 €
● F02602CD030.A	554,00 €	● F02603CD030	554,00 €	● F02604CD030.A	554,00 €
● F02602CD033.A	554,00 €	● F02603CD033	554,00 €	● F02604CD033.A	554,00 €

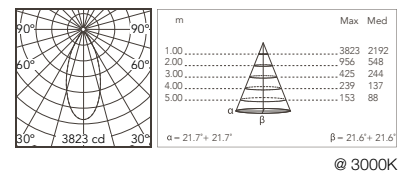

Spine L 2 Absolute: Accessoires pour les versions dimmables / Accessories for dimmable versions

Kit de connecteurs à 5 pôles: Connector kit 5-pole flying
fiche volante + fiche EU IP68. socket + EU plug IP68. F990C080000 48,00 €



Boitier de dérivation 5 pôles 4 4 way junction box 5 poles
voies (câbles 6-14 mm). IP68 (6-14 mm cables). F990C030000 62,00 €



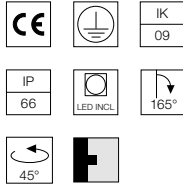
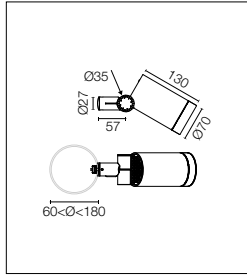

Source Power LED incluse.
Équipée d'un snoot intégré pour un plus grand confort visuel. Les collimateurs sont des accessoires disponibles pour modifier la largeur du faisceau lumineux. Source d'alimentation électrique intégrée 220-240V ON/OFF. Support pour fixation sur poteau intégré, pour des poteaux de 60 à 120 mm de diamètre et 3 mm d'épaisseur maximum. Équipée d'un câble en néoprène de 5m (10m sur commande) pour une connexion à distance; pour garantir l'étanchéité, il est conseillé d'utiliser des câbles flexibles conçus pour l'extérieur. Sur commande, version réglable 1-10V ou DALI avec source d'alimentation à distance 24Vdc.

Power LED source included.
Equipped with an integrated snoot for higher visual comfort. Collimators are available as an accessory to modify the beam opening. Integrated electric power supply 220-240V ON/OFF. Integrated support for pole fixing, for poles with a diameter between 60 and 120 mm and a maximum thickness of 3 mm. Equipped with a 5m neoprene cable (10m upon request) for remote connection. To guarantee its water tightness, it is recommended to use flexible cables designed for outdoor use. Upon request: 1-10V or DALI dimmable version with 24Vdc remote power supply.

2200K disponible sur demande.

2200K available on request.

Optic Narrow Spot 7°

Power Led: 3,5W - 168 lm ≠ FIXT 143 lm - 2700K/CRI 80 - 220-240V / 3,5W - 174 lm ≠ FIXT 149 lm - 3000K/CRI 80 - 220-240V / 3,5W - 180 lm ≠ FIXT 154 lm - 4000K/CRI 80 - 220-240V

2700K

Non Dimmable

○ F02552AA001	548,00 €
● F02552AA006	548,00 €
● F02552AA012	548,00 €
● F02552AA018	548,00 €
● F02552AA030	548,00 €
● F02552AA033	548,00 €

3000K

Non Dimmable

○ F02553AA001	548,00 €
● F02553AA006	548,00 €
● F02553AA012	548,00 €
● F02553AA018	548,00 €
● F02553AA030	548,00 €
● F02553AA033	548,00 €

4000K

Non Dimmable

○ F02554AA001	548,00 €
● F02554AA006	548,00 €
● F02554AA012	548,00 €
● F02554AA018	548,00 €
● F02554AA030	548,00 €
● F02554AA033	548,00 €

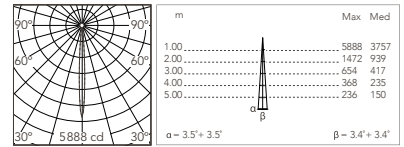

@ 3000K

Optic Spot 14°

Power Led: 7,9W - 671 lm ≠ FIXT 550 lm - 2700K/CRI 80 - 220-240V / 7,9W - 696 lm ≠ FIXT 571 lm - 3000K/CRI 80 - 220-240V / 7,9W - 720 lm ≠ FIXT 591 lm - 4000K/CRI 80 - 220-240V

2700K

Non Dimmable

○ F02552BA001	548,00 €
● F02552BA006	548,00 €
● F02552BA012	548,00 €
● F02552BA018	548,00 €
● F02552BA030	548,00 €
● F02552BA033	548,00 €

3000K

Non Dimmable

○ F02553BA001	548,00 €
● F02553BA006	548,00 €
● F02553BA012	548,00 €
● F02553BA018	548,00 €
● F02553BA030	548,00 €
● F02553BA033	548,00 €

4000K

Non Dimmable

○ F02554BA001	548,00 €
● F02554BA006	548,00 €
● F02554BA012	548,00 €
● F02554BA018	548,00 €
● F02554BA030	548,00 €
● F02554BA033	548,00 €

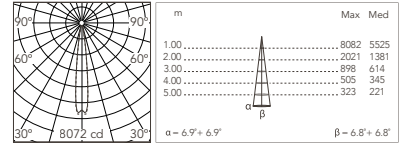

@ 3000K

Optic Medium Flood 24,5°

Power Led: 7,9W - 671 lm ≠ FIXT 499 lm - 2700K/CRI 80 - 220-240V / 7,9W - 696 lm ≠ FIXT 518 lm - 3000K/CRI 80 - 220-240V / 7,9W - 720 lm ≠ FIXT 536 lm - 4000K/CRI 80 - 220-240V

2700K

Non Dimmable

○ F02552CA001	548,00 €
● F02552CA006	548,00 €
● F02552CA012	548,00 €
● F02552CA018	548,00 €
● F02552CA030	548,00 €
● F02552CA033	548,00 €

3000K

Non Dimmable

○ F02553CA001	548,00 €
● F02553CA006	548,00 €
● F02553CA012	548,00 €
● F02553CA018	548,00 €
● F02553CA030	548,00 €
● F02553CA033	548,00 €

4000K

Non Dimmable

○ F02554CA001	548,00 €
● F02554CA006	548,00 €
● F02554CA012	548,00 €
● F02554CA018	548,00 €
● F02554CA030	548,00 €
● F02554CA033	548,00 €

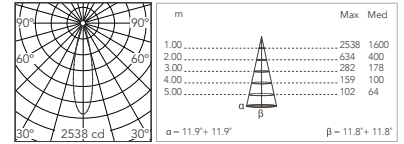

@ 3000K

Optic Flood 32°

Power Led: 7,9W - 671 lm ≠ FIXT 482 lm - 2700K/CRI 80 - 220-240V / 7,9W - 696 lm ≠ FIXT 500 lm - 3000K/CRI 80 - 220-240V / 7,9W - 720 lm ≠ FIXT 518 lm - 4000K/CRI 80 - 220-240V

2700K

Non Dimmable

○ F02552DA001	548,00 €
● F02552DA006	548,00 €
● F02552DA012	548,00 €
● F02552DA018	548,00 €
● F02552DA030	548,00 €
● F02552DA033	548,00 €

3000K

Non Dimmable

○ F02553DA001	548,00 €
● F02553DA006	548,00 €
● F02553DA012	548,00 €
● F02553DA018	548,00 €
● F02553DA030	548,00 €
● F02553DA033	548,00 €

4000K

Non Dimmable

○ F02554DA001	548,00 €
● F02554DA006	548,00 €
● F02554DA012	548,00 €
● F02554DA018	548,00 €
● F02554DA030	548,00 €
● F02554DA033	548,00 €

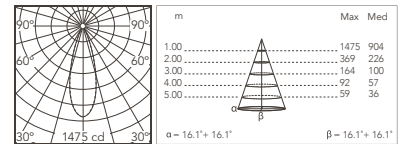

@ 3000K

Spine T 1 Pro

Optic Wide Flood 49°

Power Led: 7,9W - 671 lm ≠ FIXT 480 lm - 2700K/CRI 80 - 220-240V / 7,9W - 696 lm ≠ FIXT 490 lm - 3000K/CRI 80 - 220-240V / 7,9W - 720 lm ≠ FIXT 505 lm - 4000K/CRI 80 - 220-240V

2700K

Non Dimmable

○ F02552EA001	548,00 €
● F02552EA006	548,00 €
● F02552EA012	548,00 €
● F02552EA018	548,00 €
● F02552EA030	548,00 €
● F02552EA033	548,00 €

3000K

Non Dimmable

○ F02553EA001	548,00 €
● F02553EA006	548,00 €
● F02553EA012	548,00 €
● F02553EA018	548,00 €
● F02553EA030	548,00 €
● F02553EA033	548,00 €

4000K

Non Dimmable

○ F02554EA001	548,00 €
● F02554EA006	548,00 €
● F02554EA012	548,00 €
● F02554EA018	548,00 €
● F02554EA030	548,00 €
● F02554EA033	548,00 €

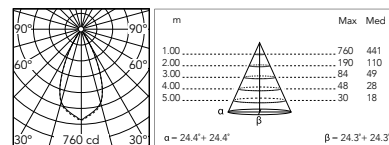

@ 3000K

Optic Elliptical 1 13,5° x 50°

Power Led: 7,9W - 671 lm ≠ FIXT 500 lm - 2700K/CRI 80 - 220-240V / 7,9W - 696 lm ≠ FIXT 519 lm - 3000K/CRI 80 - 220-240V / 7,9W - 720 lm ≠ FIXT 537 lm - 4000K/CRI 80 - 220-240V

2700K

Non Dimmable

○ F02552FA001	548,00 €
● F02552FA006	548,00 €
● F02552FA012	548,00 €
● F02552FA018	548,00 €
● F02552FA030	548,00 €
● F02552FA033	548,00 €

3000K

Non Dimmable

○ F02553FA001	548,00 €
● F02553FA006	548,00 €
● F02553FA012	548,00 €
● F02553FA018	548,00 €
● F02553FA030	548,00 €
● F02553FA033	548,00 €

4000K

Non Dimmable

○ F02554FA001	548,00 €
● F02554FA006	548,00 €
● F02554FA012	548,00 €
● F02554FA018	548,00 €
● F02554FA030	548,00 €
● F02554FA033	548,00 €

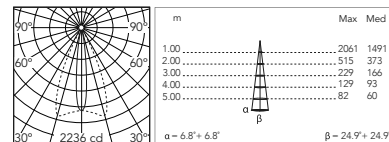

@ 3000K

Optic Elliptical 2 26° x 51°

Power Led: 7,9W - 671 lm ≠ FIXT 487 lm - 2700K/CRI 80 - 220-240V / 7,9W - 696 lm ≠ FIXT 505 lm - 3000K/CRI 80 - 220-240V / 7,9W - 720 lm ≠ FIXT 523 lm - 4000K/CRI 80 - 220-240V

2700K

Non Dimmable

○ F02552GA001	548,00 €
● F02552GA006	548,00 €
● F02552GA012	548,00 €
● F02552GA018	548,00 €
● F02552GA030	548,00 €
● F02552GA033	548,00 €

3000K

Non Dimmable

○ F02553GA001	548,00 €
● F02553GA006	548,00 €
● F02553GA012	548,00 €
● F02553GA018	548,00 €
● F02553GA030	548,00 €
● F02553GA033	548,00 €

4000K

Non Dimmable

○ F02554GA001	548,00 €
● F02554GA006	548,00 €
● F02554GA012	548,00 €
● F02554GA018	548,00 €
● F02554GA030	548,00 €
● F02554GA033	548,00 €

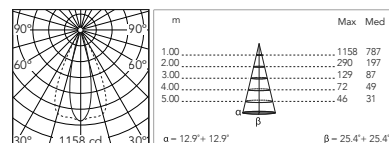

@ 3000K

Optic Wall Washer

Power Led: 7,9W - 671 lm ≠ FIXT 471 lm - 2700K/CRI 80 - 220-240V / 7,9W - 696 lm ≠ FIXT 489 lm - 3000K/CRI 80 - 220-240V / 7,9W - 720 lm ≠ FIXT 506 lm - 4000K/CRI 80 - 220-240V

2700K

Non Dimmable

○ F02552HA001	548,00 €
● F02552HA006	548,00 €
● F02552HA012	548,00 €
● F02552HA018	548,00 €
● F02552HA030	548,00 €
● F02552HA033	548,00 €

3000K

Non Dimmable

○ F02553HA001	548,00 €
● F02553HA006	548,00 €
● F02553HA012	548,00 €
● F02553HA018	548,00 €
● F02553HA030	548,00 €
● F02553HA033	548,00 €

4000K

Non Dimmable

○ F02554HA001	548,00 €
● F02554HA006	548,00 €
● F02554HA012	548,00 €
● F02554HA018	548,00 €
● F02554HA030	548,00 €
● F02554HA033	548,00 €

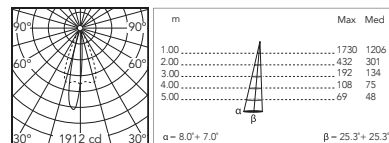

@ 3000K

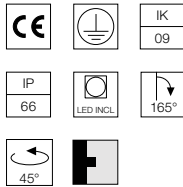
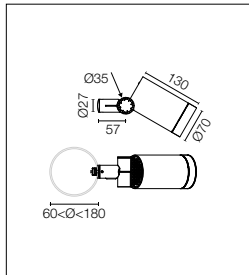

Source LED à basse consommation incluse. Équipée d'un snoot intégré pour un plus grand confort visuel. Les collimateurs sont des accessoires disponibles pour modifier la largeur du faisceau lumineux. Source d'alimentation électrique intégrée 220-240V ON/OFF. Support pour fixation sur poteau intégré, pour des poteaux de 60 à 120 mm de diamètre et 3 mm d'épaisseur maximum. Équipée d'un câble en néoprène de 5m (10m sur commande) pour une connexion à distance; pour garantir l'étanchéité, il est conseillé d'utiliser des câbles flexibles conçus pour l'extérieur. Sur commande, version réglable 1-10V ou DALI avec source d'alimentation à distance 24Vdc.

Energy-efficient Power LED source included Equipped with an integrated snoot for higher visual comfort. Collimators are available as an accessory to modify the beam opening. Integrated electric power supply 220-240V ON/OFF. Support for pole fixing, for poles with a diameter between 60 and 120 mm and a maximum thickness of 3 mm. Equipped with a 5m neoprene cable (10m upon request) for remote connection. To guarantee its water tightness, it is recommended to use flexible cables designed for outdoor use. Upon request: 1-10V or DALI dimmable version with 24Vdc remote power supply.

Optic Spot 12°

Power Led: 10,5W - 920 lm ≠ FIXT 680 lm - 2700K/CRI 80 - 220-240V / 10,5W - 966 lm ≠ FIXT 706 lm - 3000K/CRI 80 - 220-240V / 10,5W - 1012 lm ≠ FIXT 730 lm - 4000K/CRI 80 - 220-240V

2700K

Non Dimmable

○ F02562BA001	548,00 €
● F02562BA006	548,00 €
● F02562BA012	548,00 €
● F02562BA018	548,00 €
● F02562BA030	548,00 €
● F02562BA033	548,00 €

3000K

Non Dimmable

○ F02563BA001	548,00 €
● F02563BA006	548,00 €
● F02563BA012	548,00 €
● F02563BA018	548,00 €
● F02563BA030	548,00 €
● F02563BA033	548,00 €

4000K

Non Dimmable

○ F02564BA001	548,00 €
● F02564BA006	548,00 €
● F02564BA012	548,00 €
● F02564BA018	548,00 €
● F02564BA030	548,00 €
● F02564BA033	548,00 €

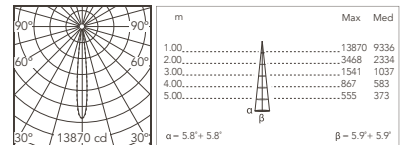

@ 3000K

Optic Medium Flood 26,5°

Power Led: 10,5W - 920 lm ≠ FIXT 594 lm - 2700K/CRI 80 - 220-240V / 10,5W - 966 lm ≠ FIXT 630 lm - 3000K/CRI 80 - 220-240V / 10,5W - 1012 lm ≠ FIXT 654 lm - 4000K/CRI 80 - 220-240V

2700K

Non Dimmable

○ F02562CA001	548,00 €
● F02562CA006	548,00 €
● F02562CA012	548,00 €
● F02562CA018	548,00 €
● F02562CA030	548,00 €
● F02562CA033	548,00 €

3000K

Non Dimmable

○ F02563CA001	548,00 €
● F02563CA006	548,00 €
● F02563CA012	548,00 €
● F02563CA018	548,00 €
● F02563CA030	548,00 €
● F02563CA033	548,00 €

4000K

Non Dimmable

○ F02564CA001	548,00 €
● F02564CA006	548,00 €
● F02564CA012	548,00 €
● F02564CA018	548,00 €
● F02564CA030	548,00 €
● F02564CA033	548,00 €

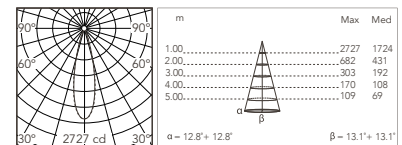

@ 3000K

Optic Flood 33,5°

Power Led: 10,5W - 920 lm ≠ FIXT 592 lm - 2700K/CRI 80 - 220-240V / 10,5W - 966 lm ≠ FIXT 627 lm - 3000K/CRI 80 - 220-240V / 10,5W - 1012 lm ≠ FIXT 651 lm - 4000K/CRI 80 - 220-240V

2700K

Non Dimmable

○ F02562DA001	548,00 €
● F02562DA006	548,00 €
● F02562DA012	548,00 €
● F02562DA018	548,00 €
● F02562DA030	548,00 €
● F02562DA033	548,00 €

3000K

Non Dimmable

○ F02563DA001	548,00 €
● F02563DA006	548,00 €
● F02563DA012	548,00 €
● F02563DA018	548,00 €
● F02563DA030	548,00 €
● F02563DA033	548,00 €

4000K

Non Dimmable

○ F02564DA001	548,00 €
● F02564DA006	548,00 €
● F02564DA012	548,00 €
● F02564DA018	548,00 €
● F02564DA030	548,00 €
● F02564DA033	548,00 €

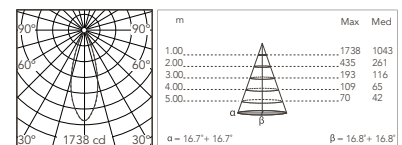

@ 3000K

Optic Wide Flood 50°

Power Led: 10,5W - 920 lm ≠ FIXT 591 lm - 2700K/CRI 80 - 220-240V / 10,5W - 966 lm ≠ FIXT 619 lm - 3000K/CRI 80 - 220-240V / 10,5W - 1012 lm ≠ FIXT 650 lm - 4000K/CRI 80 - 220-240V

2700K

Non Dimmable

○ F02562EA001	548,00 €
● F02562EA006	548,00 €
● F02562EA012	548,00 €
● F02562EA018	548,00 €
● F02562EA030	548,00 €
● F02562EA033	548,00 €

3000K

Non Dimmable

○ F02563EA001	548,00 €
● F02563EA006	548,00 €
● F02563EA012	548,00 €
● F02563EA018	548,00 €
● F02563EA030	548,00 €
● F02563EA033	548,00 €

4000K

Non Dimmable

○ F02564EA001	548,00 €
● F02564EA006	548,00 €
● F02564EA012	548,00 €
● F02564EA018	548,00 €
● F02564EA030	548,00 €
● F02564EA033	548,00 €

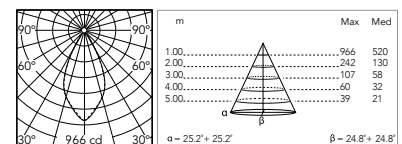

@ 3000K

Spine T 1 Pro Hp

Optic Elliptical 1 11,5° x 49°

Power Led: 10,5W - 920 lm ≠ FIXT 603 lm - 2700K/CRI 80 - 220-240V / 10,5W - 966 lm ≠ FIXT 639 lm - 3000K/CRI 80 - 220-240V / 10,5W - 1012 lm ≠ FIXT 663 lm - 4000K/CRI 80 - 220-240V

2700K

Non Dimmable

○ F02562FA001	548,00 €
● F02562FA006	548,00 €
● F02562FA012	548,00 €
● F02562FA018	548,00 €
● F02562FA030	548,00 €
● F02562FA033	548,00 €

3000K

Non Dimmable

○ F02563FA001	548,00 €
● F02563FA006	548,00 €
● F02563FA012	548,00 €
● F02563FA018	548,00 €
● F02563FA030	548,00 €
● F02563FA033	548,00 €

4000K

Non Dimmable

○ F02564FA001	548,00 €
● F02564FA006	548,00 €
● F02564FA012	548,00 €
● F02564FA018	548,00 €
● F02564FA030	548,00 €
● F02564FA033	548,00 €

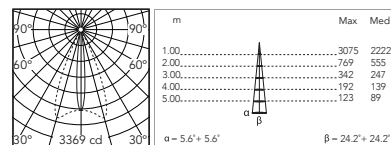

@ 3000K

Optic Elliptical 2 25,5° x 50°

Power Led: 10,5W - 920 lm ≠ FIXT 601 lm - 2700K/CRI 80 - 220-240V / 10,5W - 966 lm ≠ FIXT 624 lm - 3000K/CRI 80 - 220-240V / 10,5W - 1012 lm ≠ FIXT 645 lm - 4000K/CRI 80 - 220-240V

2700K

Non Dimmable

○ F02562GA001	548,00 €
● F02562GA006	548,00 €
● F02562GA012	548,00 €
● F02562GA018	548,00 €
● F02562GA030	548,00 €
● F02562GA033	548,00 €

3000K

Non Dimmable

○ F02563GA001	548,00 €
● F02563GA006	548,00 €
● F02563GA012	548,00 €
● F02563GA018	548,00 €
● F02563GA030	548,00 €
● F02563GA033	548,00 €

4000K

Non Dimmable

○ F02564GA001	548,00 €
● F02564GA006	548,00 €
● F02564GA012	548,00 €
● F02564GA018	548,00 €
● F02564GA030	548,00 €
● F02564GA033	548,00 €

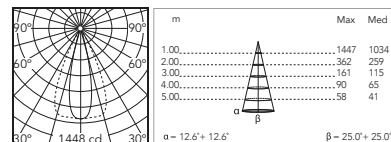

@ 3000K

Optic Wall Washer

Power Led: 10,5W - 920 lm ≠ FIXT 574 lm - 2700K/CRI 80 - 220-240V / 10,5W - 966 lm ≠ FIXT 609 lm - 3000K/CRI 80 - 220-240V / 10,5W - 1012 lm ≠ FIXT 631 lm - 4000K/CRI 80 - 220-240V

2700K

Non Dimmable

○ F02562HA001	548,00 €
● F02562HA006	548,00 €
● F02562HA012	548,00 €
● F02562HA018	548,00 €
● F02562HA030	548,00 €
● F02562HA033	548,00 €

3000K

Non Dimmable

○ F02563HA001	548,00 €
● F02563HA006	548,00 €
● F02563HA012	548,00 €
● F02563HA018	548,00 €
● F02563HA030	548,00 €
● F02563HA033	548,00 €

4000K

Non Dimmable

○ F02564HA001	548,00 €
● F02564HA006	548,00 €
● F02564HA012	548,00 €
● F02564HA018	548,00 €
● F02564HA030	548,00 €
● F02564HA033	548,00 €

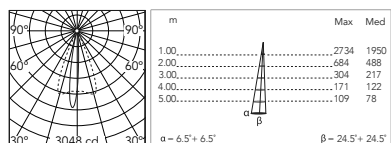

@ 3000K

Spine T 1 Pro: Accessoires / Accessories

Honeycomb Honeycomb Louvre F025Z060000 20,00 €

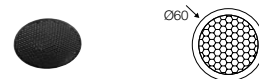

Gelbox IPX8 pour le raccordement électrique. Gelbox IPX8 for splicing connectors. F990C100000 14,00 €

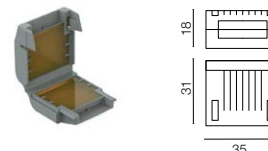

Lentilles de conversion / Converter lenses:

- Converter Spine 0 / Spine 1 Optic Medium Flood	F029Z010000	35,00 €
- Converter Spine 0 / Spine 1 Optic Flood	F029Z011000	35,00 €
- Converter Spine 0 / Spine 1 Optic Wide Flood	F029Z012000	35,00 €
- Converter Spine 0 / Spine 1 Optic Elliptic 1	F029Z013000	35,00 €
- Converter Spine 0 / Spine 1 Optic Elliptic 2	F029Z014000	35,00 €
- Converter Spine 0 / Spine 1 Optic Wall Washer	F029Z015000	35,00 €



Système de jonction IP68 H2O Stop anti-condensation à 2 voies 4 pôles. 2 way terminal block 4 poles IP68 H2O Stop. F990C00A000 33,00 €



Système de jonction IP68 H2O Stop anti-condensation à 3/4 voies 4 pôles. (Ø5,5÷12mm câble). 3/4 way terminal block 4 poles IP68 H2O Stop. (Ø5,5÷12mm cable). F990C010000 60,00 €



Optic Medium Flood 28°

Power Led: 10,5W - 920 lm ≠ FIXT 715 lm - 2700K/CRI 80 - 220-240V / 10,5W - 966 lm ≠ FIXT 742 lm - 3000K/CRI 80 - 220-240V / 10,5W - 1012 lm ≠ FIXT 767 lm - 4000K/CRI 80 - 220-240V

2700K		3000K		4000K	
Non Dimmable		Non Dimmable		Non Dimmable	
○ F02652CA001	668,00 €	○ F02653CA001	668,00 €	○ F02654CA001	668,00 €
● F02652CA006	668,00 €	● F02653CA006	668,00 €	● F02654CA006	668,00 €
● F02652CA012	668,00 €	● F02653CA012	668,00 €	● F02654CA012	668,00 €
● F02652CA018	668,00 €	● F02653CA018	668,00 €	● F02654CA018	668,00 €
● F02652CA030	668,00 €	● F02653CA030	668,00 €	● F02654CA030	668,00 €
● F02652CA033	668,00 €	● F02653CA033	668,00 €	● F02654CA033	668,00 €
1-10V					
○ F02652CB001	720,00 €	○ F02653CB001	720,00 €	○ F02654CB001	720,00 €
● F02652CB006	720,00 €	● F02653CB006	720,00 €	● F02654CB006	720,00 €
● F02652CB012	720,00 €	● F02653CB012	720,00 €	● F02654CB012	720,00 €
● F02652CB018	720,00 €	● F02653CB018	720,00 €	● F02654CB018	720,00 €
● F02652CB030	720,00 €	● F02653CB030	720,00 €	● F02654CB030	720,00 €
● F02652CB033	720,00 €	● F02653CB033	720,00 €	● F02654CB033	720,00 €
Dali					
○ F02652CD001	720,00 €	○ F02653CD001	720,00 €	○ F02654CD001	720,00 €
● F02652CD006	720,00 €	● F02653CD006	720,00 €	● F02654CD006	720,00 €
● F02652CD012	720,00 €	● F02653CD012	720,00 €	● F02654CD012	720,00 €
● F02652CD018	720,00 €	● F02653CD018	720,00 €	● F02654CD018	720,00 €
● F02652CD030	720,00 €	● F02653CD030	720,00 €	● F02654CD030	720,00 €
● F02652CD033	720,00 €	● F02653CD033	720,00 €	● F02654CD033	720,00 €

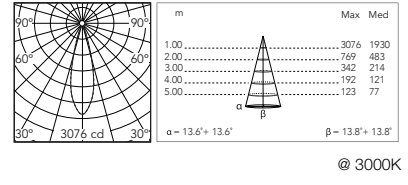

Optic Flood 33°

Power Led: 10,5W - 920 lm ≠ FIXT 695 lm - 2700K/CRI 80 - 220-240V / 10,5W - 966 lm ≠ FIXT 721 lm - 3000K/CRI 80 - 220-240V / 10,5W - 1012 lm ≠ FIXT 746 lm - 4000K/CRI 80 - 220-240V

2700K		3000K		4000K	
Non Dimmable		Non Dimmable		Non Dimmable	
○ F02652DA001	668,00 €	○ F02653DA001	668,00 €	○ F02654DA001	668,00 €
● F02652DA006	668,00 €	● F02653DA006	668,00 €	● F02654DA006	668,00 €
● F02652DA012	668,00 €	● F02653DA012	668,00 €	● F02654DA012	668,00 €
● F02652DA018	668,00 €	● F02653DA018	668,00 €	● F02654DA018	668,00 €
● F02652DA030	668,00 €	● F02653DA030	668,00 €	● F02654DA030	668,00 €
● F02652DA033	668,00 €	● F02653DA033	668,00 €	● F02654DA033	668,00 €
1-10V					
○ F02652DB001	720,00 €	○ F02653DB001	720,00 €	○ F02654DB001	720,00 €
● F02652DB006	720,00 €	● F02653DB006	720,00 €	● F02654DB006	720,00 €
● F02652DB012	720,00 €	● F02653DB012	720,00 €	● F02654DB012	720,00 €
● F02652DB018	720,00 €	● F02653DB018	720,00 €	● F02654DB018	720,00 €
● F02652DB030	720,00 €	● F02653DB030	720,00 €	● F02654DB030	720,00 €
● F02652DB033	720,00 €	● F02653DB033	720,00 €	● F02654DB033	720,00 €
Dali					
○ F02652DD001	720,00 €	○ F02653DD001	720,00 €	○ F02654DD001	720,00 €
● F02652DD006	720,00 €	● F02653DD006	720,00 €	● F02654DD006	720,00 €
● F02652DD012	720,00 €	● F02653DD012	720,00 €	● F02654DD012	720,00 €
● F02652DD018	720,00 €	● F02653DD018	720,00 €	● F02654DD018	720,00 €
● F02652DD030	720,00 €	● F02653DD030	720,00 €	● F02654DD030	720,00 €
● F02652DD033	720,00 €	● F02653DD033	720,00 €	● F02654DD033	720,00 €

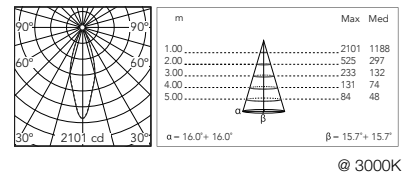

Optic Wide Flood 51°

Power Led: 10,5W - 920 lm ≠ FIXT 711 lm - 2700K/CRI 80 - 220-240V / 10,5W - 966 lm ≠ FIXT 741 lm - 3000K/CRI 80 - 220-240V / 10,5W - 1012 lm ≠ FIXT 778 lm - 4000K/CRI 80 - 220-240V

2700K		3000K		4000K	
Non Dimmable		Non Dimmable		Non Dimmable	
○ F02652EA001	668,00 €	○ F02653EA001	668,00 €	○ F02654EA001	668,00 €
● F02652EA006	668,00 €	● F02653EA006	668,00 €	● F02654EA006	668,00 €
● F02652EA012	668,00 €	● F02653EA012	668,00 €	● F02654EA012	668,00 €
● F02652EA018	668,00 €	● F02653EA018	668,00 €	● F02654EA018	668,00 €
● F02652EA030	668,00 €	● F02653EA030	668,00 €	● F02654EA030	668,00 €
● F02652EA033	668,00 €	● F02653EA033	668,00 €	● F02654EA033	668,00 €
1-10V					
○ F02652EB001	720,00 €	○ F02653EB001	720,00 €	○ F02654EB001	720,00 €
● F02652EB006	720,00 €	● F02653EB006	720,00 €	● F02654EB006	720,00 €
● F02652EB012	720,00 €	● F02653EB012	720,00 €	● F02654EB012	720,00 €
● F02652EB018	720,00 €	● F02653EB018	720,00 €	● F02654EB018	720,00 €
● F02652EB030	720,00 €	● F02653EB030	720,00 €	● F02654EB030	720,00 €
● F02652EB033	720,00 €	● F02653EB033	720,00 €	● F02654EB033	720,00 €
Dali					
○ F02652ED001	720,00 €	○ F02653ED001	720,00 €	○ F02654ED001	720,00 €
● F02652ED006	720,00 €	● F02653ED006	720,00 €	● F02654ED006	720,00 €
● F02652ED012	720,00 €	● F02653ED012	720,00 €	● F02654ED012	720,00 €
● F02652ED018	720,00 €	● F02653ED018	720,00 €	● F02654ED018	720,00 €
● F02652ED030	720,00 €	● F02653ED030	720,00 €	● F02654ED030	720,00 €
● F02652ED033	720,00 €	● F02653ED033	720,00 €	● F02654ED033	720,00 €

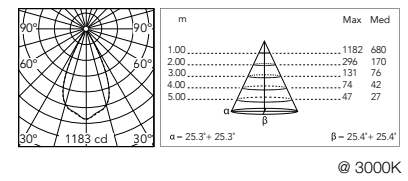

Optic Elliptical 1 9,5° x 48°

Power Led: 10,5W - 920 lm ≠ FIXT 717 lm - 2700K/CRI 80 - 220-240V / 10,5W - 966 lm ≠ FIXT 744 lm - 3000K/CRI 80 - 220-240V / 10,5W - 1012 lm ≠ FIXT 770 lm - 4000K/CRI 80 - 220-240V

2700K		3000K		4000K	
Non Dimmable		Non Dimmable		Non Dimmable	
○ F02652FA001	668,00 €	○ F02653FA001	668,00 €	○ F02654FA001	668,00 €
● F02652FA006	668,00 €	● F02653FA006	668,00 €	● F02654FA006	668,00 €
● F02652FA012	668,00 €	● F02653FA012	668,00 €	● F02654FA012	668,00 €
● F02652FA018	668,00 €	● F02653FA018	668,00 €	● F02654FA018	668,00 €
● F02652FA030	668,00 €	● F02653FA030	668,00 €	● F02654FA030	668,00 €
● F02652FA033	668,00 €	● F02653FA033	668,00 €	● F02654FA033	668,00 €
1-10V					
○ F02652FB001	720,00 €	○ F02653FB001	720,00 €	○ F02654FB001	720,00 €
● F02652FB006	720,00 €	● F02653FB006	720,00 €	● F02654FB006	720,00 €
● F02652FB012	720,00 €	● F02653FB012	720,00 €	● F02654FB012	720,00 €
● F02652FB018	720,00 €	● F02653FB018	720,00 €	● F02654FB018	720,00 €
● F02652FB030	720,00 €	● F02653FB030	720,00 €	● F02654FB030	720,00 €
● F02652FB033	720,00 €	● F02653FB033	720,00 €	● F02654FB033	720,00 €
Dali					
○ F02652FD001	720,00 €	○ F02653FD001	720,00 €	○ F02654FD001	720,00 €
● F02652FD006	720,00 €	● F02653FD006	720,00 €	● F02654FD006	720,00 €
● F02652FD012	720,00 €	● F02653FD012	720,00 €	● F02654FD012	720,00 €
● F02652FD018	720,00 €	● F02653FD018	720,00 €	● F02654FD018	720,00 €
● F02652FD030	720,00 €	● F02653FD030	720,00 €	● F02654FD030	720,00 €
● F02652FD033	720,00 €	● F02653FD033	720,00 €	● F02654FD033	720,00 €

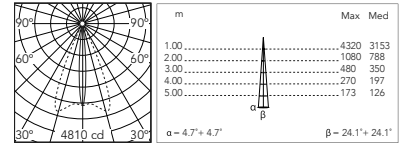

@ 3000K

Optic Elliptical 2 24° x 50°

Power Led: 10,5W - 920 lm ≠ FIXT 699 lm - 2700K/CRI 80 - 220-240V / 10,5W - 966 lm ≠ FIXT 725 lm - 3000K/CRI 80 - 220-240V / 10,5W - 1012 lm ≠ FIXT 750 lm - 4000K/CRI 80 - 220-240V

2700K		3000K		4000K	
Non Dimmable		Non Dimmable		Non Dimmable	
○ F02652GA001	668,00 €	○ F02653GA001	668,00 €	○ F02654GA001	668,00 €
● F02652GA006	668,00 €	● F02653GA006	668,00 €	● F02654GA006	668,00 €
● F02652GA012	668,00 €	● F02653GA012	668,00 €	● F02654GA012	668,00 €
● F02652GA018	668,00 €	● F02653GA018	668,00 €	● F02654GA018	668,00 €
● F02652GA030	668,00 €	● F02653GA030	668,00 €	● F02654GA030	668,00 €
● F02652GA033	668,00 €	● F02653GA033	668,00 €	● F02654GA033	668,00 €
1-10V					
○ F02652GB001	720,00 €	○ F02653GB001	720,00 €	○ F02654GB001	720,00 €
● F02652GB006	720,00 €	● F02653GB006	720,00 €	● F02654GB006	720,00 €
● F02652GB012	720,00 €	● F02653GB012	720,00 €	● F02654GB012	720,00 €
● F02652GB018	720,00 €	● F02653GB018	720,00 €	● F02654GB018	720,00 €
● F02652GB030	720,00 €	● F02653GB030	720,00 €	● F02654GB030	720,00 €
● F02652GB033	720,00 €	● F02653GB033	720,00 €	● F02654GB033	720,00 €
Dali					
○ F02652GD001	720,00 €	○ F02653GD001	720,00 €	○ F02654GD001	720,00 €
● F02652GD006	720,00 €	● F02653GD006	720,00 €	● F02654GD006	720,00 €
● F02652GD012	720,00 €	● F02653GD012	720,00 €	● F02654GD012	720,00 €
● F02652GD018	720,00 €	● F02653GD018	720,00 €	● F02654GD018	720,00 €
● F02652GD030	720,00 €	● F02653GD030	720,00 €	● F02654GD030	720,00 €
● F02652GD033	720,00 €	● F02653GD033	720,00 €	● F02654GD033	720,00 €

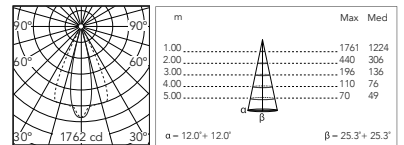

@ 3000K

Optic Wall Washer

Power Led: 10,5W - 920 lm ≠ FIXT 673 lm - 2700K/CRI 80 - 220-240V / 10,5W - 966 lm ≠ FIXT 698 lm - 3000K/CRI 80 - 220-240V / 10,5W - 1012 lm ≠ FIXT 672 lm - 4000K/CRI 80 - 220-240V

2700K		3000K		4000K	
Non Dimmable		Non Dimmable		Non Dimmable	
○ F02652HA001	668,00 €	○ F02653HA001	668,00 €	○ F02654HA001	668,00 €
● F02652HA006	668,00 €	● F02653HA006	668,00 €	● F02654HA006	668,00 €
● F02652HA012	668,00 €	● F02653HA012	668,00 €	● F02654HA012	668,00 €
● F02652HA018	668,00 €	● F02653HA018	668,00 €	● F02654HA018	668,00 €
● F02652HA030	668,00 €	● F02653HA030	668,00 €	● F02654HA030	668,00 €
● F02652HA033	668,00 €	● F02653HA033	668,00 €	● F02654HA033	668,00 €
1-10V					
○ F02652HB001	720,00 €	○ F02653HB001	720,00 €	○ F02654HB001	720,00 €
● F02652HB006	720,00 €	● F02653HB006	720,00 €	● F02654HB006	720,00 €
● F02652HB012	720,00 €	● F02653HB012	720,00 €	● F02654HB012	720,00 €
● F02652HB018	720,00 €	● F02653HB018	720,00 €	● F02654HB018	720,00 €
● F02652HB030	720,00 €	● F02653HB030	720,00 €	● F02654HB030	720,00 €
● F02652HB033	720,00 €	● F02653HB033	720,00 €	● F02654HB033	720,00 €
Dali					
○ F02652HD001	720,00 €	○ F02653HD001	720,00 €	○ F02654HD001	720,00 €
● F02652HD006	720,00 €	● F02653HD006	720,00 €	● F02654HD006	720,00 €
● F02652HD012	720,00 €	● F02653HD012	720,00 €	● F02654HD012	720,00 €
● F02652HD018	720,00 €	● F02653HD018	720,00 €	● F02654HD018	720,00 €
● F02652HD030	720,00 €	● F02653HD030	720,00 €	● F02654HD030	720,00 €
● F02652HD033	720,00 €	● F02653HD033	720,00 €	● F02654HD033	720,00 €

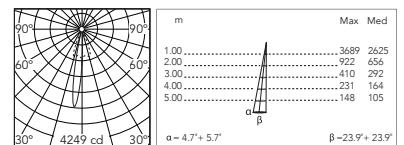

@ 3000K

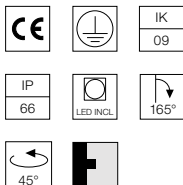
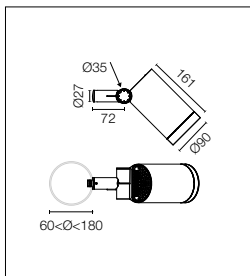

Source LED à basse consommation incluse. Équipée d'un snoot intégré pour un plus grand confort visuel. Les collimateurs sont des accessoires disponibles pour modifier la largeur du faisceau lumineux. Source d'alimentation électrique intégrée 220-240V ON/OFF et réglable 1-10V ou DALI. Support pour fixation sur poteau intégré, pour des poteaux de 60 à 120 mm de diamètre et 3 mm d'épaisseur maximum. Équipée d'un câble en néoprène de 5m (10m sur commande) pour une connexion à distance; pour garantir l'étanchéité, il est conseillé d'utiliser des câbles flexibles conçus pour l'extérieur.

Energy-efficient Power LED source included Equipped with an integrated snoot for higher visual comfort. Collimators are available as an accessory to modify the beam opening. Integrated electric power supply 220-240V ON/OFF and adjustable 1-10V or DALI. Integrated support for pole fixing, for poles with a diameter between 60 and 120 mm and a maximum thickness of 3 mm. Equipped with a 5m neoprene cable (10m upon request) for remote connection. To guarantee its water tightness, it is recommended to use flexible cables designed for outdoor use.

2200K disponible sur demande.

2200K available on request.

Optic Spot 14,5°

Power Led: 17W - 1739 lm ≠ FIXT 1443 lm - 2700K/CRI 80 - 220-240V / 17W - 1803 lm ≠ FIXT 1497 lm - 3000K/CRI 80 - 220-240V / 17W - 1868 lm ≠ FIXT 1548 lm - 4000K/CRI 80 - 220-240V

2700K

Non Dimmable

○ F02662BA001	668,00 €
● F02662BA006	668,00 €
● F02662BA012	668,00 €
● F02662BA018	668,00 €
● F02662BA030	668,00 €
● F02662BA033	668,00 €
1-10V	
○ F02662BB001	720,00 €
● F02662BB006	720,00 €
● F02662BB012	720,00 €
● F02662BB018	720,00 €
● F02662BB030	720,00 €
● F02662BB033	720,00 €
Dali	
○ F02662BD001	720,00 €
● F02662BD006	720,00 €
● F02662BD012	720,00 €
● F02662BD018	720,00 €
● F02662BD030	720,00 €
● F02662BD033	720,00 €

3000K

Non Dimmable

○ F02663BA001	668,00 €
● F02663BA006	668,00 €
● F02663BA012	668,00 €
● F02663BA018	668,00 €
● F02663BA030	668,00 €
● F02663BA033	668,00 €
1-10V	
○ F02663BB001	720,00 €
● F02663BB006	720,00 €
● F02663BB012	720,00 €
● F02663BB018	720,00 €
● F02663BB030	720,00 €
● F02663BB033	720,00 €
Dali	
○ F02663BD001	720,00 €
● F02663BD006	720,00 €
● F02663BD012	720,00 €
● F02663BD018	720,00 €
● F02663BD030	720,00 €
● F02663BD033	720,00 €

4000K

Non Dimmable

○ F02664BA001	668,00 €
● F02664BA006	668,00 €
● F02664BA012	668,00 €
● F02664BA018	668,00 €
● F02664BA030	668,00 €
● F02664BA033	668,00 €
1-10V	
○ F02664BB001	720,00 €
● F02664BB006	720,00 €
● F02664BB012	720,00 €
● F02664BB018	720,00 €
● F02664BB030	720,00 €
● F02664BB033	720,00 €
Dali	
○ F02664BD001	720,00 €
● F02664BD006	720,00 €
● F02664BD012	720,00 €
● F02664BD018	720,00 €
● F02664BD030	720,00 €
● F02664BD033	720,00 €

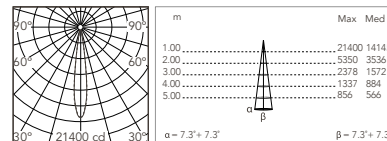

@ 3000K

Optic Medium Flood 26°

Power Led: 17W - 1739 lm ≠ FIXT 1336 lm - 2700K/CRI 80 - 220-240V / 17W - 1803 lm ≠ FIXT 1386 lm - 3000K/CRI 80 - 220-240V / 17W - 1868 lm ≠ FIXT 1434 lm - 4000K/CRI 80 - 220-240V

2700K

Non Dimmable

○ F02662CA001	668,00 €
● F02662CA006	668,00 €
● F02662CA012	668,00 €
● F02662CA018	668,00 €
● F02662CA030	668,00 €
● F02662CA033	668,00 €
1-10V	
○ F02662CB001	720,00 €
● F02662CB006	720,00 €
● F02662CB012	720,00 €
● F02662CB018	720,00 €
● F02662CB030	720,00 €
● F02662CB033	720,00 €
Dali	
○ F02662CD001	720,00 €
● F02662CD006	720,00 €
● F02662CD012	720,00 €
● F02662CD018	720,00 €
● F02662CD030	720,00 €
● F02662CD033	720,00 €

3000K

Non Dimmable

○ F02663CA001	668,00 €
● F02663CA006	668,00 €
● F02663CA012	668,00 €
● F02663CA018	668,00 €
● F02663CA030	668,00 €
● F02663CA033	668,00 €
1-10V	
○ F02663CB001	720,00 €
● F02663CB006	720,00 €
● F02663CB012	720,00 €
● F02663CB018	720,00 €
● F02663CB030	720,00 €
● F02663CB033	720,00 €
Dali	
○ F02663CD001	720,00 €
● F02663CD006	720,00 €
● F02663CD012	720,00 €
● F02663CD018	720,00 €
● F02663CD030	720,00 €
● F02663CD033	720,00 €

4000K

Non Dimmable

○ F02664CA001	668,00 €
● F02664CA006	668,00 €
● F02664CA012	668,00 €
● F02664CA018	668,00 €
● F02664CA030	668,00 €
● F02664CA033	668,00 €
1-10V	
○ F02664CB001	720,00 €
● F02664CB006	720,00 €
● F02664CB012	720,00 €
● F02664CB018	720,00 €
● F02664CB030	720,00 €
● F02664CB033	720,00 €
Dali	
○ F02664CD001	720,00 €
● F02664CD006	720,00 €
● F02664CD012	720,00 €
● F02664CD018	720,00 €
● F02664CD030	720,00 €
● F02664CD033	720,00 €

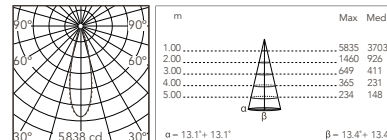

@ 3000K

Optic Elliptical 2 25° x 52°

Power Led: 17W - 1739 lm ≠ FIXT 1298 lm - 2700K/CRI 80 - 220-240V / 17W - 1803 lm ≠ FIXT 1351 lm - 3000K/CRI 80 - 220-240V / 17W - 1868 lm ≠ FIXT 1393 lm - 4000K/CRI 80 - 220-240V

2700K

Non Dimmable

- F02662GA001 668,00 €
- F02662GA006 668,00 €
- F02662GA012 668,00 €
- F02662GA018 668,00 €
- F02662GA030 668,00 €
- F02662GA033 668,00 €

1-10V

- F02662GB001 720,00 €
- F02662GB006 720,00 €
- F02662GB012 720,00 €
- F02662GB018 720,00 €
- F02662GB030 720,00 €
- F02662GB033 720,00 €

Dali

- F02662GD001 720,00 €
- F02662GD006 720,00 €
- F02662GD012 720,00 €
- F02662GD018 720,00 €
- F02662GD030 720,00 €
- F02662GD033 720,00 €

3000K

Non Dimmable

- F02663GA001 668,00 €
- F02663GA006 668,00 €
- F02663GA012 668,00 €
- F02663GA018 668,00 €
- F02663GA030 668,00 €
- F02663GA033 668,00 €

1-10V

- F02663GB001 720,00 €
- F02663GB006 720,00 €
- F02663GB012 720,00 €
- F02663GB018 720,00 €
- F02663GB030 720,00 €
- F02663GB033 720,00 €

Dali

- F02663GD001 720,00 €
- F02663GD006 720,00 €
- F02663GD012 720,00 €
- F02663GD018 720,00 €
- F02663GD030 720,00 €
- F02663GD033 720,00 €

4000K

Non Dimmable

- F02664GA001 668,00 €
- F02664GA006 668,00 €
- F02664GA012 668,00 €
- F02664GA018 668,00 €
- F02664GA030 668,00 €
- F02664GA033 668,00 €

1-10V

- F02664GB001 720,00 €
- F02664GB006 720,00 €
- F02664GB012 720,00 €
- F02664GB018 720,00 €
- F02664GB030 720,00 €
- F02664GB033 720,00 €

Dali

- F02664GD001 720,00 €
- F02664GD006 720,00 €
- F02664GD012 720,00 €
- F02664GD018 720,00 €
- F02664GD030 720,00 €
- F02664GD033 720,00 €

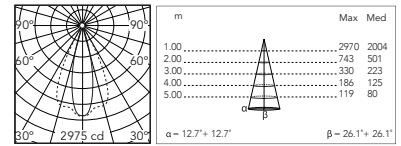

@ 3000K

Optic Wall Washer

Power Led: 17W - 1739 lm ≠ FIXT 1277 lm - 2700K/CRI 80 - 220-240V / 17W - 1803 lm ≠ FIXT 1325 lm - 3000K/CRI 80 - 220-240V / 17W - 1868 lm ≠ FIXT 1370 lm - 4000K/CRI 80 - 220-240V

2700K

Non Dimmable

- F02662HA001 668,00 €
- F02662HA006 668,00 €
- F02662HA012 668,00 €
- F02662HA018 668,00 €
- F02662HA030 668,00 €
- F02662HA033 668,00 €

1-10V

- F02662HB001 720,00 €
- F02662HB006 720,00 €
- F02662HB012 720,00 €
- F02662HB018 720,00 €
- F02662HB030 720,00 €
- F02662HB033 720,00 €

Dali

- F02662HD001 720,00 €
- F02662HD006 720,00 €
- F02662HD012 720,00 €
- F02662HD018 720,00 €
- F02662HD030 720,00 €
- F02662HD033 720,00 €

3000K

Non Dimmable

- F02663HA001 668,00 €
- F02663HA006 668,00 €
- F02663HA012 668,00 €
- F02663HA018 668,00 €
- F02663HA030 668,00 €
- F02663HA033 668,00 €

1-10V

- F02663HB001 720,00 €
- F02663HB006 720,00 €
- F02663HB012 720,00 €
- F02663HB018 720,00 €
- F02663HB030 720,00 €
- F02663HB033 720,00 €

Dali

- F02663HD001 720,00 €
- F02663HD006 720,00 €
- F02663HD012 720,00 €
- F02663HD018 720,00 €
- F02663HD030 720,00 €
- F02663HD033 720,00 €

4000K

Non Dimmable

- F02664HA001 668,00 €
- F02664HA006 668,00 €
- F02664HA012 668,00 €
- F02664HA018 668,00 €
- F02664HA030 668,00 €
- F02664HA033 668,00 €

1-10V

- F02664HB001 720,00 €
- F02664HB006 720,00 €
- F02664HB012 720,00 €
- F02664HB018 720,00 €
- F02664HB030 720,00 €
- F02664HB033 720,00 €





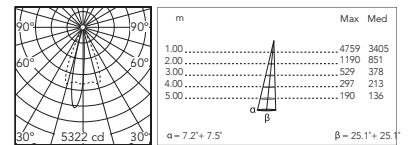





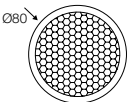

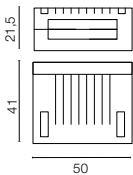
Dali

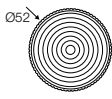
- F02664HD001 720,00 €
- F02664HD006 720,00 €
- F02664HD012 720,00 €
- F02664HD018 720,00 €
- F02664HD030 720,00 €
- F02664HD033 720,00 €

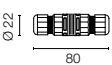

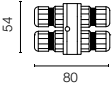
@ 3000K

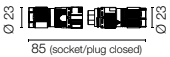
Spine T 2 Pro: Accessoires / Accessories

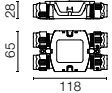
Honeycomb	Honeycomb Louvre	F026Z060000	21,00 €		
Gelbox IPX8 pour le raccordement électrique.	Gelbox IPX8 for splicing connectors.	F990C110000	22,00 €		
Lentilles de conversion / Converter lenses:					
- Converter Spine 2 Optic Medium Flood		F029Z020000	37,00 €		
- Converter Spine 2 Optic Flood		F029Z021000	37,00 €		
- Converter Spine 2 Optic Wide Flood		F029Z022000	37,00 €		
- Converter Spine 2 Optic Elliptic 1		F029Z023000	37,00 €		
- Converter Spine 2 Optic Elliptic 2		F029Z024000	37,00 €		
- Converter Spine 2 Optic Wall Washer		F029Z025000	37,00 €		
Système de jonction IP68 H2O Stop anti-condensation à 2 voies 4 pôles.	2 way terminal block 4 poles IP68 H2O Stop.	F990C00A000	33,00 €		
Système de jonction IP68 H2O Stop anti-condensation à 3/4 voies 4 pôles. (Ø5,5÷12mm câble).	3/4 way terminal block 4 poles IP68 H2O Stop. (Ø5,5÷12mm câble).	F990C010000	60,00 €		
Kit de connecteurs à 5 pôles: fiche volante + fiche EU IP68.	Connector kit 5-pole flying socket + EU plug IP68.	F990C080000	48,00 €		
Boitier de dérivation 5 pôles 4 voies (câbles 6-14 mm).	4 way junction box 5 poles IP68 (6-14 mm cables).	F990C030000	62,00 €		



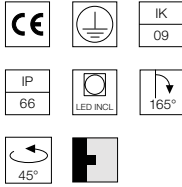
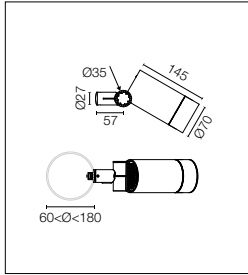

Source Power LED incluse. Équipée d'un snoot intégré pour un plus grand confort visuel: viseur asymétrique disponible en tant qu'accessoire. Les collimateurs sont des accessoires disponibles pour modifier la largeur du faisceau lumineux. Source d'alimentation électrique intégrée 220-240V ON/OFF. Support pour fixation sur poteau intégré, pour des poteaux de 60 à 120 mm de diamètre et 3 mm d'épaisseur maximum. Équipée d'un câble en néoprène de 5m (10m sur commande) pour une connexion à distance; pour garantir l'étanchéité, il est conseillé d'utiliser des câbles flexibles conçus pour l'extérieur. Sur commande, version réglable 1-10V ou DALI avec source d'alimentation à distance 24Vdc.

Power LED source included. Equipped with an integrated snoot for higher visual comfort: the asymmetrical cut visor is available as an accessory. Collimators are available as an accessory to modify the beam width. Integrated electric power supply 220-240V ON/OFF. Integrated support for pole fixing, for poles with a diameter between 60 and 120 mm and a maximum thickness of 3 mm. Equipped with a 5m neoprene cable (10m upon request) for remote connection. To guarantee its water tightness, it is recommended to use flexible cables designed for outdoor use. Upon request: 1-10V or DALI dimmable version with 24Vdc remote power supply.

2200K disponible sur demande.

2200K available on request.

Optic Narrow Spot 7°

Power Led: 3,5W - 168 lm ≠ FIXT 143 lm - 2700K/CRI 80 - 220-240V / 3,5W - 174 lm ≠ FIXT 149 lm - 3000K/CRI 80 - 220-240V / 3,5W - 180 lm ≠ FIXT 154 lm - 4000K/CRI 80 - 220-240V

2700K

Non Dimmable

○ F02512AA001	564,00 €
● F02512AA006	564,00 €
● F02512AA012	564,00 €
● F02512AA018	564,00 €
● F02512AA030	564,00 €
● F02512AA033	564,00 €

3000K

Non Dimmable

○ F02513AA001	564,00 €
● F02513AA006	564,00 €
● F02513AA012	564,00 €
● F02513AA018	564,00 €
● F02513AA030	564,00 €
● F02513AA033	564,00 €

4000K

Non Dimmable

○ F02514AA001	564,00 €
● F02514AA006	564,00 €
● F02514AA012	564,00 €
● F02514AA018	564,00 €
● F02514AA030	564,00 €
● F02514AA033	564,00 €

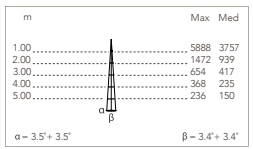
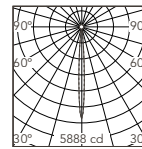

@ 3000K

Optic Spot 14°

Power Led: 7,9W - 671 lm ≠ FIXT 550 lm - 2700K/CRI 80 - 220-240V / 7,9W - 696 lm ≠ FIXT 571 lm - 3000K/CRI 80 - 220-240V / 7,9W - 720 lm ≠ FIXT 591 lm - 4000K/CRI 80 - 220-240V

2700K

Non Dimmable

○ F02512BA001	564,00 €
● F02512BA006	564,00 €
● F02512BA012	564,00 €
● F02512BA018	564,00 €
● F02512BA030	564,00 €
● F02512BA033	564,00 €

3000K

Non Dimmable

○ F02513BA001	564,00 €
● F02513BA006	564,00 €
● F02513BA012	564,00 €
● F02513BA018	564,00 €
● F02513BA030	564,00 €
● F02513BA033	564,00 €

4000K

Non Dimmable

○ F02514BA001	564,00 €
● F02514BA006	564,00 €
● F02514BA012	564,00 €
● F02514BA018	564,00 €
● F02514BA030	564,00 €
● F02514BA033	564,00 €

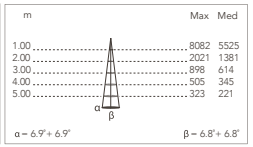
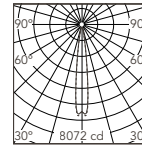

@ 3000K

Optic Medium Flood 24,5°

Power Led: 7,9W - 671 lm ≠ FIXT 499 lm - 2700K/CRI 80 - 220-240V / 7,9W - 696 lm ≠ FIXT 518 lm - 3000K/CRI 80 - 220-240V / 7,9W - 720 lm ≠ FIXT 536 lm - 4000K/CRI 80 - 220-240V

2700K

Non Dimmable

○ F02512CA001	564,00 €
● F02512CA006	564,00 €
● F02512CA012	564,00 €
● F02512CA018	564,00 €
● F02512CA030	564,00 €
● F02512CA033	564,00 €

3000K

Non Dimmable

○ F02513CA001	564,00 €
● F02513CA006	564,00 €
● F02513CA012	564,00 €
● F02513CA018	564,00 €
● F02513CA030	564,00 €
● F02513CA033	564,00 €

4000K

Non Dimmable

○ F02514CA001	564,00 €
● F02514CA006	564,00 €
● F02514CA012	564,00 €
● F02514CA018	564,00 €
● F02514CA030	564,00 €
● F02514CA033	564,00 €

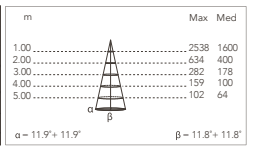
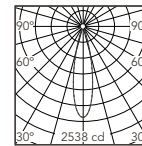

@ 3000K

Optic Flood 32°

Power Led: 7,9W - 671 lm ≠ FIXT 482 lm - 2700K/CRI 80 - 220-240V / 7,9W - 696 lm ≠ FIXT 500 lm - 3000K/CRI 80 - 220-240V / 7,9W - 720 lm ≠ FIXT 518 lm - 4000K/CRI 80 - 220-240V

2700K

Non Dimmable

○ F02512DA001	564,00 €
● F02512DA006	564,00 €
● F02512DA012	564,00 €
● F02512DA018	564,00 €
● F02512DA030	564,00 €
● F02512DA033	564,00 €

3000K

Non Dimmable

○ F02513DA001	564,00 €
● F02513DA006	564,00 €
● F02513DA012	564,00 €
● F02513DA018	564,00 €
● F02513DA030	564,00 €
● F02513DA033	564,00 €

4000K

Non Dimmable

○ F02514DA001	564,00 €
● F02514DA006	564,00 €
● F02514DA012	564,00 €
● F02514DA018	564,00 €
● F02514DA030	564,00 €
● F02514DA033	564,00 €

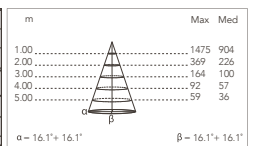
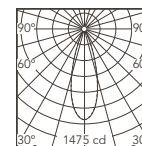

@ 3000K

Spine T 1 Ultra

Optic Wide Flood 49°

Power Led: 7,9W - 671 lm ≠ FIXT 480 lm - 2700K/CRI 80 - 220-240V / 7,9W - 696 lm ≠ FIXT 490 lm - 3000K/CRI 80 - 220-240V / 7,9W - 720 lm ≠ FIXT 505 lm - 4000K/CRI 80 - 220-240V

2700K

Non Dimmable

- F02512EA001 564,00 €
- F02512EA006 564,00 €
- F02512EA012 564,00 €
- F02512EA018 564,00 €
- F02512EA030 564,00 €
- F02512EA033 564,00 €

3000K

Non Dimmable

- F02513EA001 564,00 €
- F02513EA006 564,00 €
- F02513EA012 564,00 €
- F02513EA018 564,00 €
- F02513EA030 564,00 €
- F02513EA033 564,00 €

4000K

Non Dimmable

- F02514EA001 564,00 €
- F02514EA006 564,00 €
- F02514EA012 564,00 €
- F02514EA018 564,00 €
- F02514EA030 564,00 €
- F02514EA033 564,00 €

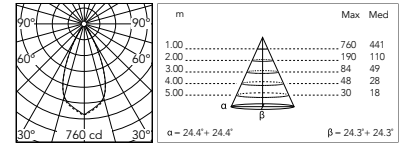

@ 3000K

Optic Elliptical 1 13,5° x 50°

Power Led: 7,9W - 671 lm ≠ FIXT 500 lm - 2700K/CRI 80 - 220-240V / 7,9W - 696 lm ≠ FIXT 519 lm - 3000K/CRI 80 - 220-240V / 7,9W - 720 lm ≠ FIXT 537 lm - 4000K/CRI 80 - 220-240V

2700K

Non Dimmable

- F02512FA001 564,00 €
- F02512FA006 564,00 €
- F02512FA012 564,00 €
- F02512FA018 564,00 €
- F02512FA030 564,00 €
- F02512FA033 564,00 €

3000K

Non Dimmable

- F02513FA001 564,00 €
- F02513FA006 564,00 €
- F02513FA012 564,00 €
- F02513FA018 564,00 €
- F02513FA030 564,00 €
- F02513FA033 564,00 €

4000K

Non Dimmable

- F02514FA001 564,00 €
- F02514FA006 564,00 €
- F02514FA012 564,00 €
- F02514FA018 564,00 €
- F02514FA030 564,00 €
- F02514FA033 564,00 €

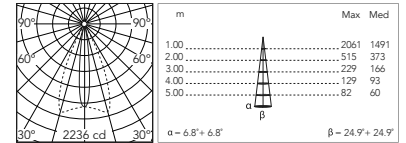

@ 3000K

Optic Elliptical 2 26° x 51°

Power Led: 7,9W - 671 lm ≠ FIXT 487 lm - 2700K/CRI 80 - 220-240V / 7,9W - 696 lm ≠ FIXT 505 lm - 3000K/CRI 80 - 220-240V / 7,9W - 720 lm ≠ FIXT 523 lm - 4000K/CRI 80 - 220-240V

2700K

Non Dimmable

- F02512GA001 564,00 €
- F02512GA006 564,00 €
- F02512GA012 564,00 €
- F02512GA018 564,00 €
- F02512GA030 564,00 €
- F02512GA033 564,00 €

3000K

Non Dimmable

- F02513GA001 564,00 €
- F02513GA006 564,00 €
- F02513GA012 564,00 €
- F02513GA018 564,00 €
- F02513GA030 564,00 €
- F02513GA033 564,00 €

4000K

Non Dimmable

- F02514GA001 564,00 €
- F02514GA006 564,00 €
- F02514GA012 564,00 €
- F02514GA018 564,00 €
- F02514GA030 564,00 €
- F02514GA033 564,00 €

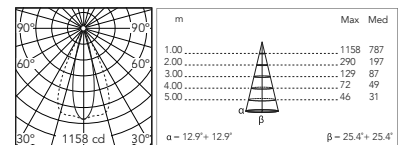

@ 3000K

Optic Wall Washer

Power Led: 7,9W - 671 lm ≠ FIXT 471 lm - 2700K/CRI 80 - 220-240V / 7,9W - 696 lm ≠ FIXT 489 lm - 3000K/CRI 80 - 220-240V / 7,9W - 720 lm ≠ FIXT 506 lm - 4000K/CRI 80 - 220-240V

2700K

Non Dimmable

- F02512HA001 564,00 €
- F02512HA006 564,00 €
- F02512HA012 564,00 €
- F02512HA018 564,00 €
- F02512HA030 564,00 €
- F02512HA033 564,00 €

3000K

Non Dimmable

- F02513HA001 564,00 €
- F02513HA006 564,00 €
- F02513HA012 564,00 €
- F02513HA018 564,00 €
- F02513HA030 564,00 €
- F02513HA033 564,00 €

4000K

Non Dimmable

- F02514HA001 564,00 €
- F02514HA006 564,00 €
- F02514HA012 564,00 €
- F02514HA018 564,00 €
- F02514HA030 564,00 €
- F02514HA033 564,00 €

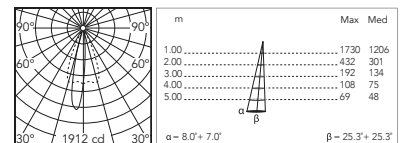

@ 3000K

Spine T 1 Ultra Hp

Optic Elliptical 1 11,5° x 49°

Power Led: 10,5W - 920 lm ≠ FIXT 603 lm - 2700K/CRI 80 - 220-240V / 10,5W - 966 lm ≠ FIXT 639 lm - 3000K/CRI 80 - 220-240V / 10,5W - 1012 lm ≠ FIXT 663 lm - 4000K/CRI 80 - 220-240V

2700K Non Dimmable		3000K Non Dimmable		4000K Non Dimmable	
○ F02522FA001	564,00 €	○ F02523FA001	564,00 €	○ F02524FA001	564,00 €
● F02522FA006	564,00 €	● F02523FA006	564,00 €	● F02524FA006	564,00 €
● F02522FA012	564,00 €	● F02523FA012	564,00 €	● F02524FA012	564,00 €
● F02522FA018	564,00 €	● F02523FA018	564,00 €	● F02524FA018	564,00 €
● F02522FA030	564,00 €	● F02523FA030	564,00 €	● F02524FA030	564,00 €
● F02522FA033	564,00 €	● F02523FA033	564,00 €	● F02524FA033	564,00 €

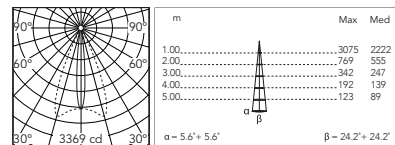

@ 3000K

Optic Elliptical 2 25,5° x 50°

Power Led: 10,5W - 920 lm ≠ FIXT 601 lm - 2700K/CRI 80 - 220-240V / 10,5W - 966 lm ≠ FIXT 624 lm - 3000K/CRI 80 - 220-240V / 10,5W - 1012 lm ≠ FIXT 645 lm - 4000K/CRI 80 - 220-240V

2700K Non Dimmable		3000K Non Dimmable		4000K Non Dimmable	
○ F02522GA001	564,00 €	○ F02523GA001	564,00 €	○ F02524GA001	564,00 €
● F02522GA006	564,00 €	● F02523GA006	564,00 €	● F02524GA006	564,00 €
● F02522GA012	564,00 €	● F02523GA012	564,00 €	● F02524GA012	564,00 €
● F02522GA018	564,00 €	● F02523GA018	564,00 €	● F02524GA018	564,00 €
● F02522GA030	564,00 €	● F02523GA030	564,00 €	● F02524GA030	564,00 €
● F02522GA033	564,00 €	● F02523GA033	564,00 €	● F02524GA033	564,00 €

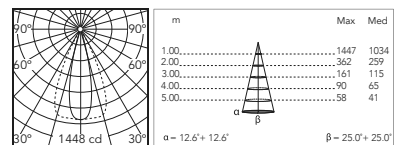

@ 3000K

Optic Wall Washer

Power Led: 10,5W - 920 lm ≠ FIXT 574 lm - 2700K/CRI 80 - 220-240V / 10,5W - 966 lm ≠ FIXT 609 lm - 3000K/CRI 80 - 220-240V / 10,5W - 1012 lm ≠ FIXT 631 lm - 4000K/CRI 80 - 220-240V

2700K Non Dimmable		3000K Non Dimmable		4000K Non Dimmable	
○ F02522HA001	564,00 €	○ F02523HA001	564,00 €	○ F02524HA001	564,00 €
● F02522HA006	564,00 €	● F02523HA006	564,00 €	● F02524HA006	564,00 €
● F02522HA012	564,00 €	● F02523HA012	564,00 €	● F02524HA012	564,00 €
● F02522HA018	564,00 €	● F02523HA018	564,00 €	● F02524HA018	564,00 €
● F02522HA030	564,00 €	● F02523HA030	564,00 €	● F02524HA030	564,00 €
● F02522HA033	564,00 €	● F02523HA033	564,00 €	● F02524HA033	564,00 €

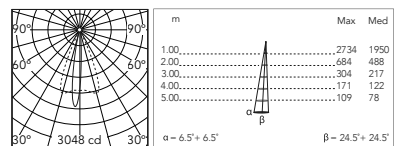

@ 3000K

Spine T 1 Ultra: Accessoires / Accessories

Visor	Visor	○ F025Z050001 ● F025Z050006 ● F025Z050012 ● F025Z050018 ● F025Z050030 ● F025Z050033	50,00 € 50,00 € 50,00 € 50,00 € 50,00 € 50,00 €	
Honeycomb	Honeycomb Louvre	F025Z060000	20,00 €	
Gelbox IPX8 pour le raccordement électrique.	Gelbox IPX8 for splicing connectors.	F990C100000	14,00 €	
Lentilles de conversion / Converter lenses:				
- Converter Spine 0 / Spine 1 Optic Medium Flood		F029Z010000	35,00 €	
- Converter Spine 0 / Spine 1 Optic Flood		F029Z011000	35,00 €	
- Converter Spine 0 / Spine 1 Optic Wide Flood		F029Z012000	35,00 €	
- Converter Spine 0 / Spine 1 Optic Elliptic 1		F029Z013000	35,00 €	
- Converter Spine 0 / Spine 1 Optic Elliptic 2		F029Z014000	35,00 €	
- Converter Spine 0 / Spine 1 Optic Wall Washer		F029Z015000	35,00 €	
Système de jonction IP68 H2O Stop anti-condensation à 2 voies 4 pôles.	2 way terminal block 4 poles IP68 H2O Stop.	F990C00A000	33,00 €	
Système de jonction IP68 H2O Stop anti-condensation à 3/4 voies 4 pôles. (Ø5,5÷12mm câble).	3/4 way terminal block 4 poles IP68 H2O Stop. (Ø5,5÷12mm câble).	F990C010000	60,00 €	

Spine

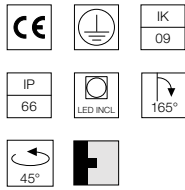
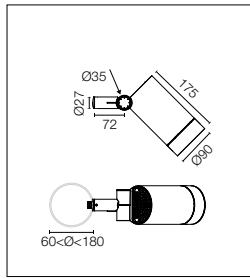

Source Power LED incluse. Équipée d'un snoot intégré pour un plus grand confort visuel: viseur asymétrique disponible en tant qu'accessoire. Les colimateurs sont des accessoires disponibles pour modifier la largeur du faisceau lumineux. Source d'alimentation électrique intégrée 220-240V ON/OFF et réglable 1-10V ou DALI. Support pour fixation sur poteau intégré, pour des poteaux de 60 à 120 mm de diamètre et 3 mm d'épaisseur maximum. Équipée d'un câble en néoprène de 5m (10m sur commande) pour une connexion à distance; pour garantir l'étanchéité, il est conseillé d'utiliser des câbles flexibles conçus pour l'extérieur.

Power LED source included. Equipped with an integrated snoot for higher visual comfort: the asymmetrical cut visor is available as an accessory. Collimators are available as an accessory to modify the beam opening. Integrated electric power supply 220-240V ON/OFF and adjustable 1-10V or DALI. Integrated support for pole fixing, for poles with a diameter between 60 and 120 mm and a maximum thickness of 3 mm. Equipped with a 5m neoprene cable (10m upon request) for remote connection. To guarantee its water tightness, it is recommended to use flexible cables designed for outdoor use.

Optic Narrow Spot
2200K disponible sur demande.

Optic Narrow Spot
2200K available on request.

Optic Narrow Spot 6°

Power Led: 4,1W - 248 lm ≠ FIXT 230 lm - 2700K/CRI 80 - 220-240V / 4,1W - 258 lm ≠ FIXT 239 lm - 3000K/CRI 80 - 220-240V / 4,1W - 267 lm ≠ FIXT 247 lm - 4000K/CRI 80 - 220-240V

2700K

Non Dimmable

○ F02612AA001	678,00 €
● F02612AA006	678,00 €
● F02612AA012	678,00 €
● F02612AA018	678,00 €
● F02612AA030	678,00 €
● F02612AA033	678,00 €
1-10V	
○ F02612AB001	736,00 €
● F02612AB006	736,00 €
● F02612AB012	736,00 €
● F02612AB018	736,00 €
● F02612AB030	736,00 €
● F02612AB033	736,00 €
Dali	
○ F02612AD001	736,00 €
● F02612AD006	736,00 €
● F02612AD012	736,00 €
● F02612AD018	736,00 €
● F02612AD030	736,00 €
● F02612AD033	736,00 €

3000K

Non Dimmable

○ F02613AA001	678,00 €
● F02613AA006	678,00 €
● F02613AA012	678,00 €
● F02613AA018	678,00 €
● F02613AA030	678,00 €
● F02613AA033	678,00 €
1-10V	
○ F02613AB001	736,00 €
● F02613AB006	736,00 €
● F02613AB012	736,00 €
● F02613AB018	736,00 €
● F02613AB030	736,00 €
● F02613AB033	736,00 €
Dali	
○ F02613AD001	736,00 €
● F02613AD006	736,00 €
● F02613AD012	736,00 €
● F02613AD018	736,00 €
● F02613AD030	736,00 €
● F02613AD033	736,00 €

4000K

Non Dimmable

○ F02614AA001	678,00 €
● F02614AA006	678,00 €
● F02614AA012	678,00 €
● F02614AA018	678,00 €
● F02614AA030	678,00 €
● F02614AA033	678,00 €
1-10V	
○ F02614AB001	736,00 €
● F02614AB006	736,00 €
● F02614AB012	736,00 €
● F02614AB018	736,00 €
● F02614AB030	736,00 €
● F02614AB033	736,00 €
Dali	
○ F02614AD001	736,00 €
● F02614AD006	736,00 €
● F02614AD012	736,00 €
● F02614AD018	736,00 €
● F02614AD030	736,00 €
● F02614AD033	736,00 €

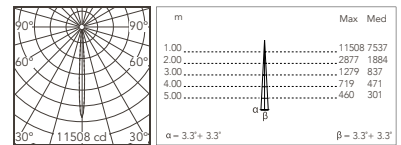

@ 3000K

Optic Spot 9,5°

Power Led: 10,5W - 920 lm ≠ FIXT 769 lm - 2700K/CRI 80 - 220-240V / 10,5W - 966 lm ≠ FIXT 808 lm - 3000K/CRI 80 - 220-240V / 10,5W - 1012 lm ≠ FIXT 846 lm - 4000K/CRI 80 - 220-240V

2700K

Non Dimmable

○ F02612BA001	678,00 €
● F02612BA006	678,00 €
● F02612BA012	678,00 €
● F02612BA018	678,00 €
● F02612BA030	678,00 €
● F02612BA033	678,00 €
1-10V	
○ F02612BB001	736,00 €
● F02612BB006	736,00 €
● F02612BB012	736,00 €
● F02612BB018	736,00 €
● F02612BB030	736,00 €
● F02612BB033	736,00 €
Dali	
○ F02612BD001	736,00 €
● F02612BD006	736,00 €
● F02612BD012	736,00 €
● F02612BD018	736,00 €
● F02612BD030	736,00 €
● F02612BD033	736,00 €

3000K

Non Dimmable

○ F02613BA001	678,00 €
● F02613BA006	678,00 €
● F02613BA012	678,00 €
● F02613BA018	678,00 €
● F02613BA030	678,00 €
● F02613BA033	678,00 €
1-10V	
○ F02613BB001	736,00 €
● F02613BB006	736,00 €
● F02613BB012	736,00 €
● F02613BB018	736,00 €
● F02613BB030	736,00 €
● F02613BB033	736,00 €
Dali	
○ F02613BD001	736,00 €
● F02613BD006	736,00 €
● F02613BD012	736,00 €
● F02613BD018	736,00 €
● F02613BD030	736,00 €
● F02613BD033	736,00 €

4000K

Non Dimmable

○ F02614BA001	678,00 €
● F02614BA006	678,00 €
● F02614BA012	678,00 €
● F02614BA018	678,00 €
● F02614BA030	678,00 €
● F02614BA033	678,00 €
1-10V	
○ F02614BB001	736,00 €
● F02614BB006	736,00 €
● F02614BB012	736,00 €
● F02614BB018	736,00 €
● F02614BB030	736,00 €
● F02614BB033	736,00 €
Dali	
○ F02614BD001	736,00 €
● F02614BD006	736,00 €
● F02614BD012	736,00 €
● F02614BD018	736,00 €
● F02614BD030	736,00 €
● F02614BD033	736,00 €

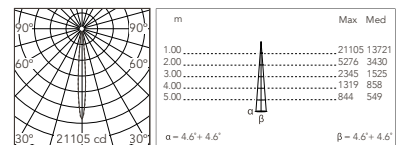

@ 3000K

Spine T 2 Ultra

Optic Medium Flood 28°

Power Led: 10,5W - 920 lm ≠ FIXT 715 lm - 2700K/CRI 80 - 220-240V / 10,5W - 966 lm ≠ FIXT 742 lm - 3000K/CRI 80 - 220-240V / 10,5W - 1012 lm ≠ FIXT 767 lm - 4000K/CRI 80 - 220-240V

2700K

Non Dimmable

○ F02612CA001	678,00 €
● F02612CA006	678,00 €
● F02612CA012	678,00 €
● F02612CA018	678,00 €
● F02612CA030	678,00 €
● F02612CA033	678,00 €
1-10V	
○ F02612CB001	736,00 €
● F02612CB006	736,00 €
● F02612CB012	736,00 €
● F02612CB018	736,00 €
● F02612CB030	736,00 €
● F02612CB033	736,00 €
Dali	
○ F02612CD001	736,00 €
● F02612CD006	736,00 €
● F02612CD012	736,00 €
● F02612CD018	736,00 €
● F02612CD030	736,00 €
● F02612CD033	736,00 €

3000K

Non Dimmable

○ F02613CA001	678,00 €
● F02613CA006	678,00 €
● F02613CA012	678,00 €
● F02613CA018	678,00 €
● F02613CA030	678,00 €
● F02613CA033	678,00 €
1-10V	
○ F02613CB001	736,00 €
● F02613CB006	736,00 €
● F02613CB012	736,00 €
● F02613CB018	736,00 €
● F02613CB030	736,00 €
● F02613CB033	736,00 €
Dali	
○ F02613CD001	736,00 €
● F02613CD006	736,00 €
● F02613CD012	736,00 €
● F02613CD018	736,00 €
● F02613CD030	736,00 €
● F02613CD033	736,00 €

4000K

Non Dimmable

○ F02614CA001	678,00 €
● F02614CA006	678,00 €
● F02614CA012	678,00 €
● F02614CA018	678,00 €
● F02614CA030	678,00 €
● F02614CA033	678,00 €
1-10V	
○ F02614CB001	736,00 €
● F02614CB006	736,00 €
● F02614CB012	736,00 €
● F02614CB018	736,00 €
● F02614CB030	736,00 €
● F02614CB033	736,00 €
Dali	
○ F02614CD001	736,00 €
● F02614CD006	736,00 €
● F02614CD012	736,00 €
● F02614CD018	736,00 €
● F02614CD030	736,00 €
● F02614CD033	736,00 €

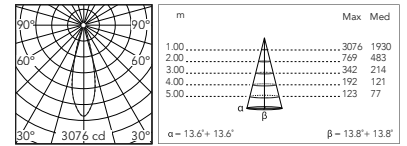

@ 3000K

Optic Flood 33°

Power Led: 10,5W - 920 lm ≠ FIXT 695 lm - 2700K/CRI 80 - 220-240V / 10,5W - 966 lm ≠ FIXT 721 lm - 3000K/CRI 80 - 220-240V / 10,5W - 1012 lm ≠ FIXT 746 lm - 4000K/CRI 80 - 220-240V

2700K

Non Dimmable

○ F02612DA001	678,00 €
● F02612DA006	678,00 €
● F02612DA012	678,00 €
● F02612DA018	678,00 €
● F02612DA030	678,00 €
● F02612DA033	678,00 €
1-10V	
○ F02612DB001	736,00 €
● F02612DB006	736,00 €
● F02612DB012	736,00 €
● F02612DB018	736,00 €
● F02612DB030	736,00 €
● F02612DB033	736,00 €
Dali	
○ F02612DD001	736,00 €
● F02612DD006	736,00 €
● F02612DD012	736,00 €
● F02612DD018	736,00 €
● F02612DD030	736,00 €
● F02612DD033	736,00 €

3000K

Non Dimmable

○ F02613DA001	678,00 €
● F02613DA006	678,00 €
● F02613DA012	678,00 €
● F02613DA018	678,00 €
● F02613DA030	678,00 €
● F02613DA033	678,00 €
1-10V	
○ F02613DB001	736,00 €
● F02613DB006	736,00 €
● F02613DB012	736,00 €
● F02613DB018	736,00 €
● F02613DB030	736,00 €
● F02613DB033	736,00 €
Dali	
○ F02613DD001	736,00 €
● F02613DD006	736,00 €
● F02613DD012	736,00 €
● F02613DD018	736,00 €
● F02613DD030	736,00 €
● F02613DD033	736,00 €

4000K

Non Dimmable

○ F02614DA001	678,00 €
● F02614DA006	678,00 €
● F02614DA012	678,00 €
● F02614DA018	678,00 €
● F02614DA030	678,00 €
● F02614DA033	678,00 €
1-10V	
○ F02614DB001	736,00 €
● F02614DB006	736,00 €
● F02614DB012	736,00 €
● F02614DB018	736,00 €
● F02614DB030	736,00 €
● F02614DB033	736,00 €
Dali	
○ F02614DD001	736,00 €
● F02614DD006	736,00 €
● F02614DD012	736,00 €
● F02614DD018	736,00 €
● F02614DD030	736,00 €
● F02614DD033	736,00 €

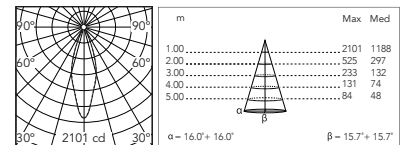

@ 3000K

Optic Wide Flood 51°

Power Led: 10,5W - 920 lm ≠ FIXT 711 lm - 2700K/CRI 80 - 220-240V / 10,5W - 966 lm ≠ FIXT 741 lm - 3000K/CRI 80 - 220-240V / 10,5W - 1012 lm ≠ FIXT 778 lm - 4000K/CRI 80 - 220-240V

2700K

Non Dimmable

○ F02612EA001	678,00 €
● F02612EA006	678,00 €
● F02612EA012	678,00 €
● F02612EA018	678,00 €
● F02612EA030	678,00 €
● F02612EA033	678,00 €
1-10V	
○ F02612EB001	736,00 €
● F02612EB006	736,00 €
● F02612EB012	736,00 €
● F02612EB018	736,00 €
● F02612EB030	736,00 €
● F02612EB033	736,00 €
Dali	
○ F02612ED001	736,00 €
● F02612ED006	736,00 €
● F02612ED012	736,00 €
● F02612ED018	736,00 €
● F02612ED030	736,00 €
● F02612ED033	736,00 €

3000K

Non Dimmable

○ F02613EA001	678,00 €
● F02613EA006	678,00 €
● F02613EA012	678,00 €
● F02613EA018	678,00 €
● F02613EA030	678,00 €
● F02613EA033	678,00 €
1-10V	
○ F02613EB001	736,00 €
● F02613EB006	736,00 €
● F02613EB012	736,00 €
● F02613EB018	736,00 €
● F02613EB030	736,00 €
● F02613EB033	736,00 €
Dali	
○ F02613ED001	736,00 €
● F02613ED006	736,00 €
● F02613ED012	736,00 €
● F02613ED018	736,00 €
● F02613ED030	736,00 €
● F02613ED033	736,00 €

4000K

Non Dimmable

○ F02614EA001	678,00 €
● F02614EA006	678,00 €
● F02614EA012	678,00 €
● F02614EA018	678,00 €
● F02614EA030	678,00 €
● F02614EA033	678,00 €
1-10V	
○ F02614EB001	736,00 €
● F02614EB006	736,00 €
● F02614EB012	736,00 €
● F02614EB018	736,00 €
● F02614EB030	736,00 €
● F02614EB033	736,00 €
Dali	
○ F02614ED001	736,00 €
● F02614ED006	736,00 €
● F02614ED012	736,00 €
● F02614ED018	736,00 €
● F02614ED030	736,00 €
● F02614ED033	736,00 €

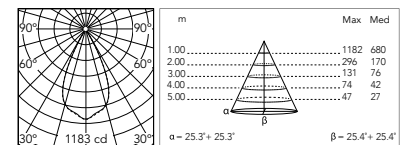

@ 3000K

Spine T 2 Ultra

Optic Elliptical 1 9,5° x 48°

Power Led: 10,5W - 920 lm ≠ FIXT 717 lm - 2700K/CRI 80 - 220-240V / 10,5W - 966 lm ≠ FIXT 744 lm - 3000K/CRI 80 - 220-240V / 10,5W - 1012 lm ≠ FIXT 770 lm - 4000K/CRI 80 - 220-240V

2700K		3000K		4000K	
Non Dimmable		Non Dimmable		Non Dimmable	
○ F02612FA001	678,00 €	○ F02613FA001	678,00 €	○ F02614FA001	678,00 €
● F02612FA006	678,00 €	● F02613FA006	678,00 €	● F02614FA006	678,00 €
● F02612FA012	678,00 €	● F02613FA012	678,00 €	● F02614FA012	678,00 €
● F02612FA018	678,00 €	● F02613FA018	678,00 €	● F02614FA018	678,00 €
● F02612FA030	678,00 €	● F02613FA030	678,00 €	● F02614FA030	678,00 €
● F02612FA033	678,00 €	● F02613FA033	678,00 €	● F02614FA033	678,00 €
1-10V					
○ F02612FB001	736,00 €	○ F02613FB001	736,00 €	○ F02614FB001	736,00 €
● F02612FB006	736,00 €	● F02613FB006	736,00 €	● F02614FB006	736,00 €
● F02612FB012	736,00 €	● F02613FB012	736,00 €	● F02614FB012	736,00 €
● F02612FB018	736,00 €	● F02613FB018	736,00 €	● F02614FB018	736,00 €
● F02612FB030	736,00 €	● F02613FB030	736,00 €	● F02614FB030	736,00 €
● F02612FB033	736,00 €	● F02613FB033	736,00 €	● F02614FB033	736,00 €
Dali					
○ F02612FD001	736,00 €	○ F02613FD001	736,00 €	○ F02614FD001	736,00 €
● F02612FD006	736,00 €	● F02613FD006	736,00 €	● F02614FD006	736,00 €
● F02612FD012	736,00 €	● F02613FD012	736,00 €	● F02614FD012	736,00 €
● F02612FD018	736,00 €	● F02613FD018	736,00 €	● F02614FD018	736,00 €
● F02612FD030	736,00 €	● F02613FD030	736,00 €	● F02614FD030	736,00 €
● F02612FD033	736,00 €	● F02613FD033	736,00 €	● F02614FD033	736,00 €

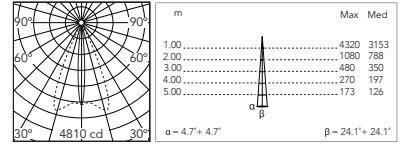

@ 3000K

Optic Elliptical 2 24° x 50°

Power Led: 10,5W - 920 lm ≠ FIXT 699 lm - 2700K/CRI 80 - 220-240V / 10,5W - 966 lm ≠ FIXT 725 lm - 3000K/CRI 80 - 220-240V / 10,5W - 1012 lm ≠ FIXT 750 lm - 4000K/CRI 80 - 220-240V

2700K		3000K		4000K	
Non Dimmable		Non Dimmable		Non Dimmable	
○ F02612GA001	678,00 €	○ F02613GA001	678,00 €	○ F02614GA001	678,00 €
● F02612GA006	678,00 €	● F02613GA006	678,00 €	● F02614GA006	678,00 €
● F02612GA012	678,00 €	● F02613GA012	678,00 €	● F02614GA012	678,00 €
● F02612GA018	678,00 €	● F02613GA018	678,00 €	● F02614GA018	678,00 €
● F02612GA030	678,00 €	● F02613GA030	678,00 €	● F02614GA030	678,00 €
● F02612GA033	678,00 €	● F02613GA033	678,00 €	● F02614GA033	678,00 €
1-10V					
○ F02612GB001	736,00 €	○ F02613GB001	736,00 €	○ F02614GB001	736,00 €
● F02612GB006	736,00 €	● F02613GB006	736,00 €	● F02614GB006	736,00 €
● F02612GB012	736,00 €	● F02613GB012	736,00 €	● F02614GB012	736,00 €
● F02612GB018	736,00 €	● F02613GB018	736,00 €	● F02614GB018	736,00 €
● F02612GB030	736,00 €	● F02613GB030	736,00 €	● F02614GB030	736,00 €
● F02612GB033	736,00 €	● F02613GB033	736,00 €	● F02614GB033	736,00 €
Dali					
○ F02612GD001	736,00 €	○ F02613GD001	736,00 €	○ F02614GD001	736,00 €
● F02612GD006	736,00 €	● F02613GD006	736,00 €	● F02614GD006	736,00 €
● F02612GD012	736,00 €	● F02613GD012	736,00 €	● F02614GD012	736,00 €
● F02612GD018	736,00 €	● F02613GD018	736,00 €	● F02614GD018	736,00 €
● F02612GD030	736,00 €	● F02613GD030	736,00 €	● F02614GD030	736,00 €
● F02612GD033	736,00 €	● F02613GD033	736,00 €	● F02614GD033	736,00 €

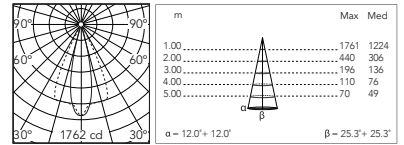

@ 3000K

Optic Wall Washer

Power Led: 10,5W - 920 lm ≠ FIXT 673 lm - 2700K/CRI 80 - 220-240V / 10,5W - 966 lm ≠ FIXT 698 lm - 3000K/CRI 80 - 220-240V / 10,5W - 1012 lm ≠ FIXT 672 lm - 4000K/CRI 80 - 220-240V

2700K		3000K		4000K	
Non Dimmable		Non Dimmable		Non Dimmable	
○ F02612HA001	678,00 €	○ F02613HA001	678,00 €	○ F02614HA001	678,00 €
● F02612HA006	678,00 €	● F02613HA006	678,00 €	● F02614HA006	678,00 €
● F02612HA012	678,00 €	● F02613HA012	678,00 €	● F02614HA012	678,00 €
● F02612HA018	678,00 €	● F02613HA018	678,00 €	● F02614HA018	678,00 €
● F02612HA030	678,00 €	● F02613HA030	678,00 €	● F02614HA030	678,00 €
● F02612HA033	678,00 €	● F02613HA033	678,00 €	● F02614HA033	678,00 €
1-10V					
○ F02612HB001	736,00 €	○ F02613HB001	736,00 €	○ F02614HB001	736,00 €
● F02612HB006	736,00 €	● F02613HB006	736,00 €	● F02614HB006	736,00 €
● F02612HB012	736,00 €	● F02613HB012	736,00 €	● F02614HB012	736,00 €
● F02612HB018	736,00 €	● F02613HB018	736,00 €	● F02614HB018	736,00 €
● F02612HB030	736,00 €	● F02613HB030	736,00 €	● F02614HB030	736,00 €
● F02612HB033	736,00 €	● F02613HB033	736,00 €	● F02614HB033	736,00 €
Dali					
○ F02612HD001	736,00 €	○ F02613HD001	736,00 €	○ F02614HD001	736,00 €
● F02612HD006	736,00 €	● F02613HD006	736,00 €	● F02614HD006	736,00 €
● F02612HD012	736,00 €	● F02613HD012	736,00 €	● F02614HD012	736,00 €
● F02612HD018	736,00 €	● F02613HD018	736,00 €	● F02614HD018	736,00 €
● F02612HD030	736,00 €	● F02613HD030	736,00 €	● F02614HD030	736,00 €
● F02612HD033	736,00 €	● F02613HD033	736,00 €	● F02614HD033	736,00 €

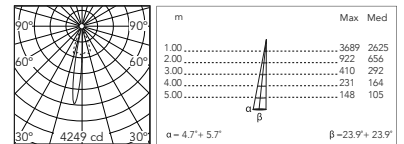

@ 3000K

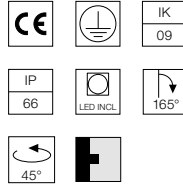
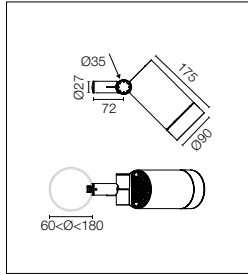

Source LED à basse consommation incluse. Équipée d'un snoot intégré pour un plus grand confort visuel: viseur asymétrique disponible en tant qu'accessoire. Les collimateurs sont des accessoires disponibles pour modifier la largeur du faisceau lumineux. Source d'alimentation électrique intégrée 220-240V ON/OFF et réglable 1-10V ou DALI. Support pour fixation sur poteau intégré, pour des poteaux de 60 à 120 mm de diamètre et 3 mm d'épaisseur maximum. Équipée d'un câble en néoprène de 5m (10m sur commande) pour une connexion à distance; pour garantir l'étanchéité, il est conseillé d'utiliser des câbles flexibles conçus pour l'extérieur.

Energy-efficient Power LED source included Equipped with an integrated snoot for higher visual comfort: the asymmetrical cut visor is available as an accessory. Collimators are available as an accessory to modify the beam opening. Integrated electric power supply 220-240V ON/OFF and adjustable 1-10V or DALI. Integrated support for pole fixing, for poles with a diameter between 60 and 120 mm and a maximum thickness of 3 mm. Equipped with a 5m neoprene cable (10m upon request) for remote connection. To guarantee its water tightness, it is recommended to use flexible cables designed for outdoor use.

2200K disponible sur demande.

2200K available on request.

Optic Spot 14,5°

Power Led: 17W - 1739 lm ≠ FIXT 1443 lm - 2700K/CRI 80 - 220-240V / 17W - 1803 lm ≠ FIXT 1497 lm - 3000K/CRI 80 - 220-240V / 17W - 1868 lm ≠ FIXT 1548 lm - 4000K/CRI 80 - 220-240V

2700K

Non Dimmable

- F02622BA001 678,00 €
- F02622BA006 678,00 €
- F02622BA012 678,00 €
- F02622BA018 678,00 €
- F02622BA030 678,00 €
- F02622BA033 678,00 €
- F02622BB001 736,00 €
- F02622BB006 736,00 €
- F02622BB012 736,00 €
- F02622BB018 736,00 €
- F02622BB030 736,00 €
- F02622BB033 736,00 €
- F02622BD001 736,00 €
- F02622BD006 736,00 €
- F02622BD012 736,00 €
- F02622BD018 736,00 €
- F02622BD030 736,00 €
- F02622BD033 736,00 €

3000K

Non Dimmable

- F02623BA001 678,00 €
- F02623BA006 678,00 €
- F02623BA012 678,00 €
- F02623BA018 678,00 €
- F02623BA030 678,00 €
- F02623BA033 678,00 €
- F02623BB001 736,00 €
- F02623BB006 736,00 €
- F02623BB012 736,00 €
- F02623BB018 736,00 €
- F02623BB030 736,00 €
- F02623BB033 736,00 €
- F02623BD001 736,00 €
- F02623BD006 736,00 €
- F02623BD012 736,00 €
- F02623BD018 736,00 €
- F02623BD030 736,00 €
- F02623BD033 736,00 €

4000K

Non Dimmable

- F02624BA001 678,00 €
- F02624BA006 678,00 €
- F02624BA012 678,00 €
- F02624BA018 678,00 €
- F02624BA030 678,00 €
- F02624BA033 678,00 €
- F02624BB001 736,00 €
- F02624BB006 736,00 €
- F02624BB012 736,00 €
- F02624BB018 736,00 €
- F02624BB030 736,00 €
- F02624BB033 736,00 €
- F02624BD001 736,00 €
- F02624BD006 736,00 €
- F02624BD012 736,00 €
- F02624BD018 736,00 €
- F02624BD030 736,00 €
- F02624BD033 736,00 €

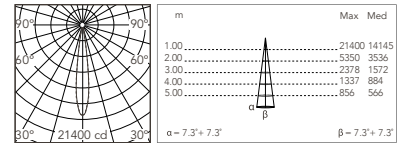

@ 3000K

Optic Medium Flood 26°

Power Led: 17W - 1739 lm ≠ FIXT 1336 lm - 2700K/CRI 80 - 220-240V / 17W - 1803 lm ≠ FIXT 1386 lm - 3000K/CRI 80 - 220-240V / 17W - 1868 lm ≠ FIXT 1434 lm - 4000K/CRI 80 - 220-240V

2700K

Non Dimmable

- F02622CA001 678,00 €
- F02622CA006 678,00 €
- F02622CA012 678,00 €
- F02622CA018 678,00 €
- F02622CA030 678,00 €
- F02622CA033 678,00 €
- F02622CB001 736,00 €
- F02622CB006 736,00 €
- F02622CB012 736,00 €
- F02622CB018 736,00 €
- F02622CB030 736,00 €
- F02622CB033 736,00 €
- F02622CD001 736,00 €
- F02622CD006 736,00 €
- F02622CD012 736,00 €
- F02622CD018 736,00 €
- F02622CD030 736,00 €
- F02622CD033 736,00 €

3000K

Non Dimmable

- F02623CA001 678,00 €
- F02623CA006 678,00 €
- F02623CA012 678,00 €
- F02623CA018 678,00 €
- F02623CA030 678,00 €
- F02623CA033 678,00 €
- F02623CB001 736,00 €
- F02623CB006 736,00 €
- F02623CB012 736,00 €
- F02623CB018 736,00 €
- F02623CB030 736,00 €
- F02623CB033 736,00 €
- F02623CD001 736,00 €
- F02623CD006 736,00 €
- F02623CD012 736,00 €
- F02623CD018 736,00 €
- F02623CD030 736,00 €
- F02623CD033 736,00 €

4000K

Non Dimmable

- F02624CA001 678,00 €
- F02624CA006 678,00 €
- F02624CA012 678,00 €
- F02624CA018 678,00 €
- F02624CA030 678,00 €
- F02624CA033 678,00 €
- F02624CB001 736,00 €
- F02624CB006 736,00 €
- F02624CB012 736,00 €
- F02624CB018 736,00 €
- F02624CB030 736,00 €
- F02624CB033 736,00 €
- F02624CD001 736,00 €
- F02624CD006 736,00 €
- F02624CD012 736,00 €
- F02624CD018 736,00 €
- F02624CD030 736,00 €
- F02624CD033 736,00 €

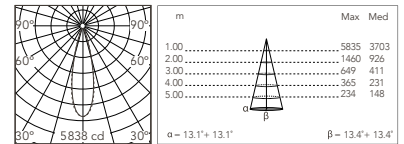

@ 3000K

Spine T 2 Ultra Hp

Optic Flood 36°

Power Led: 17W - 1739 lm ≠ FIXT 1302 lm - 2700K/CRI 80 - 220-240V / 17W - 1803 lm ≠ FIXT 1351 lm - 3000K/CRI 80 - 220-240V / 17W - 1868 lm ≠ FIXT 1397 lm - 4000K/CRI 80 - 220-240V

2700K		3000K		4000K	
Non Dimmable		Non Dimmable		Non Dimmable	
○ F02622DA001	678,00 €	○ F02623DA001	678,00 €	○ F02624DA001	678,00 €
● F02622DA006	678,00 €	● F02623DA006	678,00 €	● F02624DA006	678,00 €
● F02622DA012	678,00 €	● F02623DA012	678,00 €	● F02624DA012	678,00 €
● F02622DA018	678,00 €	● F02623DA018	678,00 €	● F02624DA018	678,00 €
● F02622DA030	678,00 €	● F02623DA030	678,00 €	● F02624DA030	678,00 €
● F02622DA033	678,00 €	● F02623DA033	678,00 €	● F02624DA033	678,00 €
1-10V					
○ F02622DB001	736,00 €	○ F02623DB001	736,00 €	○ F02624DB001	736,00 €
● F02622DB006	736,00 €	● F02623DB006	736,00 €	● F02624DB006	736,00 €
● F02622DB012	736,00 €	● F02623DB012	736,00 €	● F02624DB012	736,00 €
● F02622DB018	736,00 €	● F02623DB018	736,00 €	● F02624DB018	736,00 €
● F02622DB030	736,00 €	● F02623DB030	736,00 €	● F02624DB030	736,00 €
● F02622DB033	736,00 €	● F02623DB033	736,00 €	● F02624DB033	736,00 €
Dali					
○ F02622DD001	736,00 €	○ F02623DD001	736,00 €	○ F02624DD001	736,00 €
● F02622DD006	736,00 €	● F02623DD006	736,00 €	● F02624DD006	736,00 €
● F02622DD012	736,00 €	● F02623DD012	736,00 €	● F02624DD012	736,00 €
● F02622DD018	736,00 €	● F02623DD018	736,00 €	● F02624DD018	736,00 €
● F02622DD030	736,00 €	● F02623DD030	736,00 €	● F02624DD030	736,00 €
● F02622DD033	736,00 €	● F02623DD033	736,00 €	● F02624DD033	736,00 €

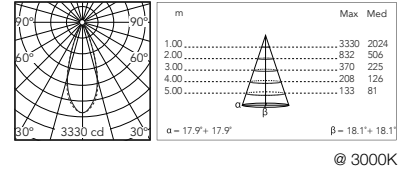

Optic Wide Flood 52°

Power Led: 17W - 1739 lm ≠ FIXT 1303 lm - 2700K/CRI 80 - 220-240V / 17W - 1803 lm ≠ FIXT 1357 lm - 3000K/CRI 80 - 220-240V / 17W - 1868 lm ≠ FIXT 1411 lm - 4000K/CRI 80 - 220-240V

2700K		3000K		4000K	
Non Dimmable		Non Dimmable		Non Dimmable	
○ F02622EA001	678,00 €	○ F02623EA001	678,00 €	○ F02624EA001	678,00 €
● F02622EA006	678,00 €	● F02623EA006	678,00 €	● F02624EA006	678,00 €
● F02622EA012	678,00 €	● F02623EA012	678,00 €	● F02624EA012	678,00 €
● F02622EA018	678,00 €	● F02623EA018	678,00 €	● F02624EA018	678,00 €
● F02622EA030	678,00 €	● F02623EA030	678,00 €	● F02624EA030	678,00 €
● F02622EA033	678,00 €	● F02623EA033	678,00 €	● F02624EA033	678,00 €
1-10V					
○ F02622EB001	736,00 €	○ F02623EB001	736,00 €	○ F02624EB001	736,00 €
● F02622EB006	736,00 €	● F02623EB006	736,00 €	● F02624EB006	736,00 €
● F02622EB012	736,00 €	● F02623EB012	736,00 €	● F02624EB012	736,00 €
● F02622EB018	736,00 €	● F02623EB018	736,00 €	● F02624EB018	736,00 €
● F02622EB030	736,00 €	● F02623EB030	736,00 €	● F02624EB030	736,00 €
● F02622EB033	736,00 €	● F02623EB033	736,00 €	● F02624EB033	736,00 €
Dali					
○ F02622ED001	736,00 €	○ F02623ED001	736,00 €	○ F02624ED001	736,00 €
● F02622ED006	736,00 €	● F02623ED006	736,00 €	● F02624ED006	736,00 €
● F02622ED012	736,00 €	● F02623ED012	736,00 €	● F02624ED012	736,00 €
● F02622ED018	736,00 €	● F02623ED018	736,00 €	● F02624ED018	736,00 €
● F02622ED030	736,00 €	● F02623ED030	736,00 €	● F02624ED030	736,00 €
● F02622ED033	736,00 €	● F02623ED033	736,00 €	● F02624ED033	736,00 €

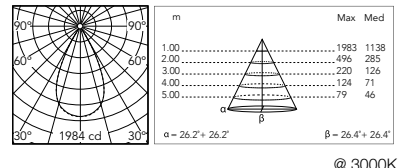

Optic Elliptical 1 14° x 50°

Power Led: 17W - 1739 lm ≠ FIXT 1315 lm - 2700K/CRI 80 - 220-240V / 17W - 1803 lm ≠ FIXT 1364 lm - 3000K/CRI 80 - 220-240V / 17W - 1868 lm ≠ FIXT 1410 lm - 4000K/CRI 80 - 220-240V

2700K		3000K		4000K	
Non Dimmable		Non Dimmable		Non Dimmable	
○ F02622FA001	678,00 €	○ F02623FA001	678,00 €	○ F02624FA001	678,00 €
● F02622FA006	678,00 €	● F02623FA006	678,00 €	● F02624FA006	678,00 €
● F02622FA012	678,00 €	● F02623FA012	678,00 €	● F02624FA012	678,00 €
● F02622FA018	678,00 €	● F02623FA018	678,00 €	● F02624FA018	678,00 €
● F02622FA030	678,00 €	● F02623FA030	678,00 €	● F02624FA030	678,00 €
● F02622FA033	678,00 €	● F02623FA033	678,00 €	● F02624FA033	678,00 €
1-10V					
○ F02622FB001	736,00 €	○ F02623FB001	736,00 €	○ F02624FB001	736,00 €
● F02622FB006	736,00 €	● F02623FB006	736,00 €	● F02624FB006	736,00 €
● F02622FB012	736,00 €	● F02623FB012	736,00 €	● F02624FB012	736,00 €
● F02622FB018	736,00 €	● F02623FB018	736,00 €	● F02624FB018	736,00 €
● F02622FB030	736,00 €	● F02623FB030	736,00 €	● F02624FB030	736,00 €
● F02622FB033	736,00 €	● F02623FB033	736,00 €	● F02624FB033	736,00 €
Dali					
○ F02622FD001	736,00 €	○ F02623FD001	736,00 €	○ F02624FD001	736,00 €
● F02622FD006	736,00 €	● F02623FD006	736,00 €	● F02624FD006	736,00 €
● F02622FD012	736,00 €	● F02623FD012	736,00 €	● F02624FD012	736,00 €
● F02622FD018	736,00 €	● F02623FD018	736,00 €	● F02624FD018	736,00 €
● F02622FD030	736,00 €	● F02623FD030	736,00 €	● F02624FD030	736,00 €
● F02622FD033	736,00 €	● F02623FD033	736,00 €	● F02624FD033	736,00 €

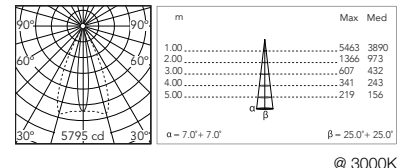

Spine T 2 Ultra Hp

Optic Elliptical 2 25° x 52°

Power Led: 17W - 1739 lm ≠ FIXT 1298 lm - 2700K/CRI 80 - 220-240V / 17W - 1803 lm ≠ FIXT 1351 lm - 3000K/CRI 80 - 220-240V / 17W - 1868 lm ≠ FIXT 1393 lm - 4000K/CRI 80 - 220-240V

2700K

Non Dimmable

- F02622GA001 678,00 €
- F02622GA006 678,00 €
- F02622GA012 678,00 €
- F02622GA018 678,00 €
- F02622GA030 678,00 €
- F02622GA033 678,00 €

1-10V

- F02622GB001 736,00 €
- F02622GB006 736,00 €
- F02622GB012 736,00 €
- F02622GB018 736,00 €
- F02622GB030 736,00 €
- F02622GB033 736,00 €

Dali

- F02622GD001 736,00 €
- F02622GD006 736,00 €
- F02622GD012 736,00 €
- F02622GD018 736,00 €
- F02622GD030 736,00 €
- F02622GD033 736,00 €

3000K

Non Dimmable

- F02623GA001 678,00 €
- F02623GA006 678,00 €
- F02623GA012 678,00 €
- F02623GA018 678,00 €
- F02623GA030 678,00 €
- F02623GA033 678,00 €

1-10V

- F02623GB001 736,00 €
- F02623GB006 736,00 €
- F02623GB012 736,00 €
- F02623GB018 736,00 €
- F02623GB030 736,00 €
- F02623GB033 736,00 €

Dali

- F02623GD001 736,00 €
- F02623GD006 736,00 €
- F02623GD012 736,00 €
- F02623GD018 736,00 €
- F02623GD030 736,00 €
- F02623GD033 736,00 €

4000K

Non Dimmable

- F02624GA001 678,00 €
- F02624GA006 678,00 €
- F02624GA012 678,00 €
- F02624GA018 678,00 €
- F02624GA030 678,00 €
- F02624GA033 678,00 €

1-10V

- F02624GB001 736,00 €
- F02624GB006 736,00 €
- F02624GB012 736,00 €
- F02624GB018 736,00 €
- F02624GB030 736,00 €
- F02624GB033 736,00 €

Dali

- F02624GD001 736,00 €
- F02624GD006 736,00 €
- F02624GD012 736,00 €
- F02624GD018 736,00 €
- F02624GD030 736,00 €
- F02624GD033 736,00 €

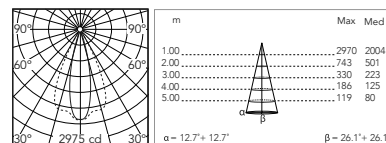

@ 3000K

Optic Wall Washer

Power Led: 17W - 1739 lm ≠ FIXT 1277 lm - 2700K/CRI 80 - 220-240V / 17W - 1803 lm ≠ FIXT 1325 lm - 3000K/CRI 80 - 220-240V / 17W - 1868 lm ≠ FIXT 1370 lm - 4000K/CRI 80 - 220-240V

2700K

Non Dimmable

- F02622HA001 678,00 €
- F02622HA006 678,00 €
- F02622HA012 678,00 €
- F02622HA018 678,00 €
- F02622HA030 678,00 €
- F02622HA033 678,00 €

1-10V

- F02622HB001 736,00 €
- F02622HB006 736,00 €
- F02622HB012 736,00 €
- F02622HB018 736,00 €
- F02622HB030 736,00 €
- F02622HB033 736,00 €

Dali

- F02622HD001 736,00 €
- F02622HD006 736,00 €
- F02622HD012 736,00 €
- F02622HD018 736,00 €
- F02622HD030 736,00 €
- F02622HD033 736,00 €

3000K

Non Dimmable

- F02623HA001 678,00 €
- F02623HA006 678,00 €
- F02623HA012 678,00 €
- F02623HA018 678,00 €
- F02623HA030 678,00 €
- F02623HA033 678,00 €

1-10V

- F02623HB001 736,00 €
- F02623HB006 736,00 €
- F02623HB012 736,00 €
- F02623HB018 736,00 €
- F02623HB030 736,00 €
- F02623HB033 736,00 €

Dali

- F02623HD001 736,00 €
- F02623HD006 736,00 €
- F02623HD012 736,00 €
- F02623HD018 736,00 €
- F02623HD030 736,00 €
- F02623HD033 736,00 €

4000K

Non Dimmable

- F02624HA001 678,00 €
- F02624HA006 678,00 €
- F02624HA012 678,00 €
- F02624HA018 678,00 €
- F02624HA030 678,00 €
- F02624HA033 678,00 €

1-10V

- F02624HB001 736,00 €
- F02624HB006 736,00 €
- F02624HB012 736,00 €
- F02624HB018 736,00 €
- F02624HB030 736,00 €
- F02624HB033 736,00 €





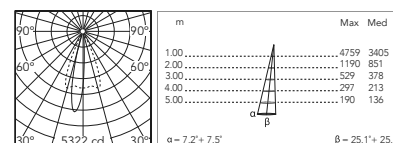





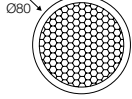

Dali

- F02624HD001 736,00 €
- F02624HD006 736,00 €
- F02624HD012 736,00 €
- F02624HD018 736,00 €
- F02624HD030 736,00 €
- F02624HD033 736,00 €

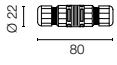

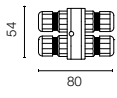

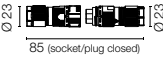

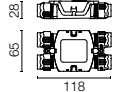

@ 3000K

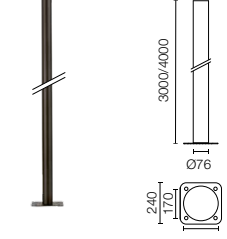
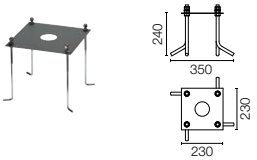
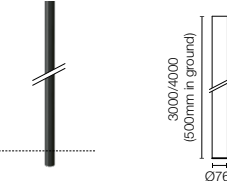
Spine T 2 Ultra: Accessoires / Accessories

Visor	Visor	<ul style="list-style-type: none"> ○ F026Z050001 ● F026Z050006 ● F026Z050012 ● F026Z050018 ● F026Z050030 ● F026Z050033 	57,00 € 57,00 € 57,00 € 57,00 € 57,00 € 57,00 €		
Honeycomb	Honeycomb Louvre	F026Z060000	21,00 €		
Gelbox IPX8 pour le raccordement électrique.	Gelbox IPX8 for splicing connectors.	F990C110000	22,00 €		
Lentilles de conversion / Converter lenses:					
- Converter Spine 2 Optic Medium Flood		F029Z020000	37,00 €		
- Converter Spine 2 Optic Flood		F029Z021000	37,00 €		
- Converter Spine 2 Optic Wide Flood		F029Z022000	37,00 €		
- Converter Spine 2 Optic Elliptic 1		F029Z023000	37,00 €		
- Converter Spine 2 Optic Elliptic 2		F029Z024000	37,00 €		
- Converter Spine 2 Optic Wall Washer		F029Z025000	37,00 €		
Système de jonction IP68 H2O Stop anti-condensation à 2 voies 4 pôles.	2 way terminal block 4 poles IP68 H2O Stop.	F990C00A000	33,00 €		
Système de jonction IP68 H2O Stop anti-condensation à 3/4 voies 4 pôles. (Ø5,5÷12mm câble).	3/4 way terminal block 4 poles IP68 H2O Stop. (ø5,5÷12mm cable).	F990C010000	60,00 €		
Kit de connecteurs à 5 pôles: fiche volante + fiche EU IP68.	Connector kit 5-pole flying socket + EU plug IP68.	F990C080000	48,00 €		
Boitier de dérivation 5 pôles 4 voies (câbles 6-14 mm).	4 way junction box 5 poles IP68 (6-14 mm cables).	F990C030000	62,00 €		

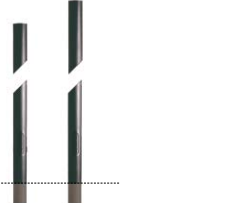
Spine T: Accessoires / Accessories

Mât Spine, Ø76 mm, en aluminium verni avec pied.	Spine, Ø76 mm, painted aluminum pole with foot.	H: 3000 mm ● F026Z200006 860,00 € ● F026Z200018 860,00 € ● F026Z200033 860,00 € H: 4000 mm ● F026Z210006 881,00 € ● F026Z210018 881,00 € ● F026Z210033 881,00 €	
Plaque de base avec boulon pour poteau en aluminium Ø76 mm avec version de base.	Base plate with bolt for aluminium Pole Ø76 mm with base version.	F990G300000 97,00 €	
Mât Spine, Ø76 mm, en aluminium verni à enterrer (+500 mm en terre).	Spine, Ø76 mm, painted aluminum pole for in ground installation (+500 mm into the ground)	H: 3000 mm ● F026Z220006 632,00 € ● F026Z220018 632,00 € ● F026Z220033 632,00 € H: 4000 mm ● F026Z230006 652,00 € ● F026Z230018 652,00 € ● F026Z230033 652,00 €	
Avec base et boîte de dérivation.	Pole Ø76 mm with Base and Access Door. With Terminal Block 4x1,5-16mmq.	H 3500 mm ● FA24806 702,00 € ● FA24833 702,00 € H 4500 mm ● FA24906 852,00 € ● FA24933 852,00 €	
Encastrable (+500 mm en dessous du sol) Avec boîte de dérivation	Pole Ø76 mm In-Ground (+500 mm Root) With Access Door With Terminal Block 4x1,5-16mmq	H 3500 mm ● FA25006 644,00 € ● FA25033 644,00 € H 4500 mm ● FA25106 759,00 € ● FA25133 759,00 €	
Avec base et boîte de dérivation.	Pole Ø102 mm with Base and Access Door. With Terminal Block 4x1,5-16mmq.	H 4000 mm ● FA414006 852,00 € ● FA414033 852,00 € H 5000 mm ● FA415006 978,00 € ● FA415033 978,00 €	
Encastrable (+500 mm en dessous du sol) Avec boîte de dérivation	Pole Ø102 mm In-Ground (+500 mm Root) With Access Door With Terminal Block 4x1,5-16mmq	H 4000 mm ● FA414506 773,00 € ● FA414533 773,00 € H 5000 mm ● FA415506 932,00 € ● FA415533 932,00 €	
Plaque à boulons pour poteau Ø76 mm ou Ø102 mm avec base.	Bolt plate for Pole Ø76 mm or Ø102 mm with base.	FA116 97,00 €	

Pointbreak

Designed by Piero Lissoni





Pointbreak Ballisage 2



Pointbreak Wall 1

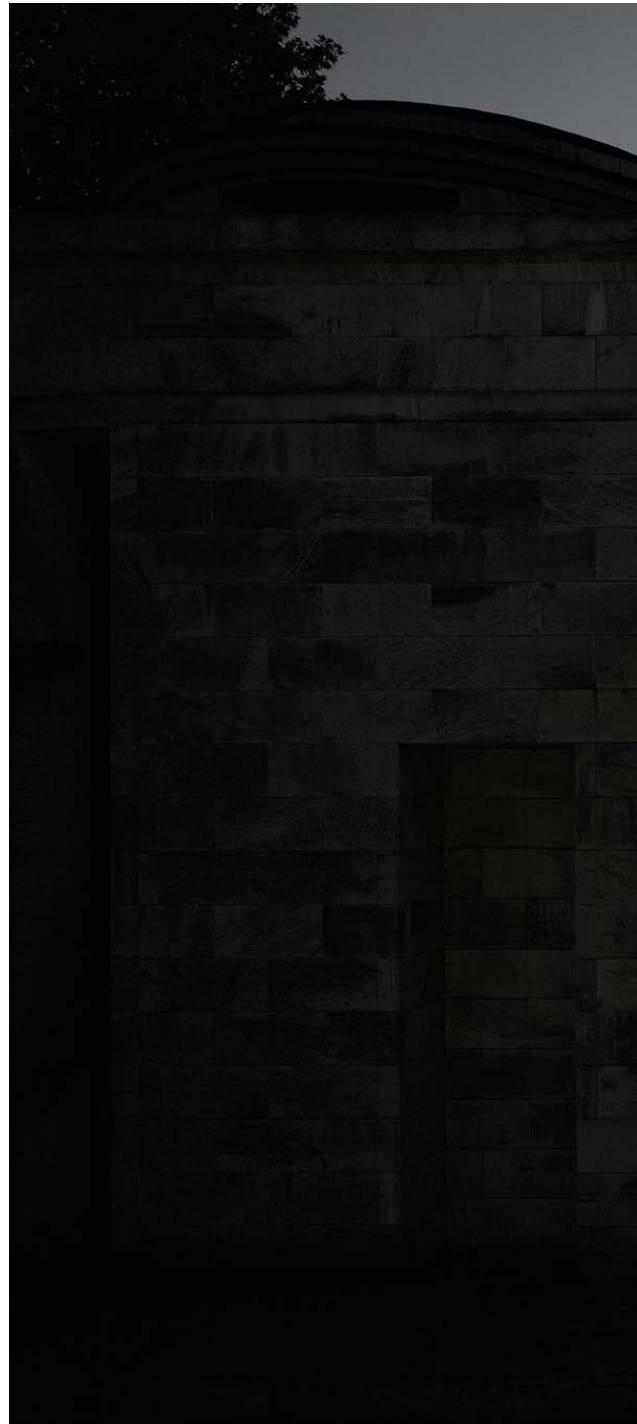



Famille / Family

Pointbreak Bollard 1

**Power Led**

5,6W
274 lm - 2700K/CRI 80
285 lm - 3000K/CRI 80
307 lm - 4000K/CRI 80
[2200K available on request.](#)

Pointbreak Balisage 1

**Power Led**

5,6W
274 lm - 2700K/CRI 80
285 lm - 3000K/CRI 80
307 lm - 4000K/CRI 80
[2200K available on request.](#)

Pointbreak Bollard 2

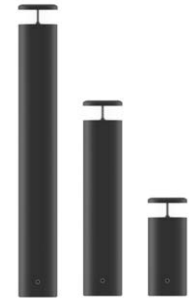
**Power Led**

12,5W
600 lm - 2700K/CRI 80
624 lm - 3000K/CRI 80
672 lm - 4000K/CRI 80
[2200K available on request.](#)

Pointbreak Balisage 2

**Power Led**

12,5W
600 lm - 2700K/CRI 80
624 lm - 3000K/CRI 80
672 lm - 4000K/CRI 80
[2200K available on request.](#)

Finitions / Colours



01 White



06 Grey



12 Forest Green



18 Deep Brown



30 Black



33 Anthracite

Pointbreak Wall 0



Power Led

2,1W

up to 101 lm - 2700K/CRI 80

up to 104 lm - 3000K/CRI 80

up to 108 lm - 4000K/CRI 80

2200K available on request.

Power Led

3,1W

up to 2x101 lm - 2700K/CRI 80

up to 2x104 lm - 3000K/CRI 80

up to 2x108 lm - 4000K/CRI 80

2200K available on request.

Pointbreak Wall 1



Power Led

5,5W

319 lm - 2700K/CRI 80

335 lm - 3000K/CRI 80

367 lm - 4000K/CRI 80

Power Led

12W

2x319 lm - 2700K/CRI 80

2x335 lm - 3000K/CRI 80

2x367 lm - 4000K/CRI 80

Pointbreak Wall 2



Power Led

17W

1108 lm - 2700K/CRI 80

1149 lm - 3000K/CRI 80

1190 lm - 4000K/CRI 80

2200K available on request.

Power Led

32W

2x1108 lm - 2700K/CRI 80

2x1149 lm - 3000K/CRI 80

2x1190 lm - 4000K/CRI 80

2200K available on request.

Pointbreak Ceiling 0



Power Led

2,1W

up to 101 lm - 2700K/CRI 80

up to 104 lm - 3000K/CRI 80

up to 108 lm - 4000K/CRI 80

2200K available on request.

Pointbreak Ceiling 1



Power Led

5,5W

319 lm - 2700K/CRI 80

335 lm - 3000K/CRI 80

367 lm - 4000K/CRI 80

Pointbreak Ceiling 2



Power Led

17W

1108 lm - 2700K/CRI 80

1149 lm - 3000K/CRI 80

1190 lm - 4000K/CRI 80

2200K available on request.

Pointbreak Bollard

Collection de bornes LED d'extérieur au design exclusif, caractérisée par une optique à haut rendement. L'exclusive forme squircle est disponible en trois tailles et trois hauteurs. Structure du corps en aluminium extrudé, tête du luminaire en aluminium moulé sous pression, diffuseur en polycarbonate transparent avec traitement de surface antirayures et stabilisé aux UV. L'optique intégrée dans la tête permet une émission de lumière radiale asymétrique vers le bas qui, combinée au réflecteur en aluminium peint en noir absolu, évite les reflets indirects pour respecter les lois en vigueur sur la pollution lumineuse.

Disponible en différentes finitions avec un revêtement à poudre double couche et une surface traitée par procédé de conversion chimique pour garantir une haute résistance à la corrosion.

Les versions Bollard peuvent être facilement installées sur tout type de sol à l'aide de chevilles, soit en utilisant la base en technopolymère de haute résistance, y compris contre la corrosion, et l'élément de fixation qui permet un réglage précis, soit en utilisant la plaque d'ancrage accessoire spécifique pour que la base du produit soit entièrement intégrée au sol. Les vis de fixation de la borne sont en acier inoxydable AISI 316L brunis pour les finitions sombres.

Pointbreak Balisage

Collection de luminaires LED d'extérieur partiellement encastrables au design exclusif, caractérisée par une optique à haut rendement.

L'exclusive forme squircle est disponible en deux tailles et deux hauteurs. Structure du corps en aluminium extrudé, tête du luminaire en aluminium moulé sous pression, diffuseur en polycarbonate transparent avec traitement de surface antirayures et stabilisé aux UV. L'optique intégrée dans la tête permet une émission de lumière radiale asymétrique vers le bas qui, combinée au réflecteur en aluminium peint en noir absolu, évite les reflets indirects pour respecter les lois en vigueur sur la pollution lumineuse. Disponible en différentes finitions avec un revêtement à poudre double couche et une surface traitée par procédé de conversion chimique pour garantir une haute résistance à la corrosion.

Traitement anticorrosion (ACT) breveté pour la partie encastrée dans le sol.

Les versions balisage sont facilement installées au sol à l'aide d'un coffrage spécial obligatoire qui doit être commandé séparément.

Pointbreak Wall

Collection de luminaires LED muraux d'extérieur au design exclusif, caractérisée par une optique à haut rendement. L'exclusive forme squircle est disponible en trois tailles avec émission unidirectionnelle ou bidirectionnelle. Structure en aluminium moulé avec verre de fermeture transparent. L'optique intégrée, située sur la partie intérieure, utilise des lentilles brevetées et est protégée par un blindage en couleur noir absolu qui optimise le confort visuel tout en maintenant un haut rendement.

Disponible en différentes finitions avec un revêtement à poudre double couche et une surface traitée par procédé de conversion chimique pour garantir une haute résistance à la corrosion.

L'installation est réalisée au moyen d'un support en PBT (polybutylène téréphtalate) qui est très résistant, y compris à la corrosion. Presse-étoupe double installé directement sur le corps du luminaire pour permettre le câblage d'entrée et de sortie.

Pointbreak Ceiling

Collection de luminaires LED d'extérieur pour plafond au design exclusif, caractérisée par une optique à haut rendement.

L'exclusive forme squircle est disponible en trois tailles. Structure en aluminium moulé avec verre de fermeture transparent. L'optique intégrée, située sur la partie intérieure, utilise des lentilles brevetées et est protégée par un blindage en couleur noir absolu qui optimise le confort visuel tout en maintenant un haut rendement.

Disponible en différentes finitions avec un revêtement à poudre double couche et une surface traitée par procédé de conversion chimique pour garantir une haute résistance à la corrosion.

L'installation est réalisée au moyen d'un élément de fixation qui permet un ajustement précis. Presse-étoupe double installé directement sur le corps du luminaire pour permettre le câblage d'entrée et de sortie.

Pointbreak Bollard

Collection of outdoor bollards with an exclusive design and LED light source, characterized by high-performance optics. The unique squircle shape is available in three sizes and three heights. The body structure comes in extruded aluminum, the head of the luminaire in cast aluminum, and the diffuser is made of transparent, UV-stabilized polycarbonate with scratch-resistant surface treatment. The optics integrated in the head allows an asymmetric, downward radial light emission that, combined with an aluminum reflector painted in absolute black, avoids indirect reflections in compliance with current light pollution laws. Available in different finishes with a double layer of powder coating and chemical conversion surface treatment to ensure high resistance against corrosion. Bollard versions may be easily installed on any flooring on the ground with anchors by using the high-resistance, corrosion-free technopolymer base and a fixing element, allowing a fine adjustment; or by using the specific accessory anchoring plate for a flawless integration of the base of the product with the ground. The anchoring hardware is made of AISI 316L burnished for dark finishes.

Pointbreak Balisage

Collection of partially-recessed outdoor luminaires with an exclusive design and LED light source, characterized by high-performance optics. The unique squircle shape is available in two sizes and two heights. The body structure comes in extruded aluminum, the head of the luminaire in cast aluminum, and the diffuser is made of transparent, UV-stabilized polycarbonate with scratch-resistant surface treatment. The optics integrated in the head allows an asymmetric, downward radial light emission that, combined with an aluminum reflector painted in absolute black, avoids indirect reflections in compliance with current light pollution laws. Available in different finishes with a double layer of powder coating and chemical conversion surface treatment to ensure high resistance against corrosion. Patented anticorrosive treatment (ACT) for the part fitted into the ground. Balisage versions are easily installed on the ground with a mandatory special box for installation, to be ordered separately.

Pointbreak Wall

Collection of outdoor wall luminaires with an exclusive design and LED light source, characterized by high-performance optics. The unique squircle shape is available in three sizes, with uni- or bi-directional emission. Cast aluminum structure with transparent closing glass. The integrated optics, located at the bottom, uses patented lenses and is protected by an absolute black screening to optimize visual comfort while maintaining high performance. Available in different finishes with a double layer of powder coating and chemical conversion surface treatment to ensure high resistance against corrosion. The installation is made using a highly resistant and corrosion-free PBT (polybutylenterephthalate) bracket. Double cable gland installed directly in the body of the luminaire for inlet and outlet connection.

Pointbreak Ceiling

Collection of outdoor ceiling luminaires with an exclusive design and LED light source, characterized by high-performance optics. The unique squircle shape is available in three sizes. Cast aluminum structure with transparent closing glass. The integrated optics, located at the bottom, uses patented lenses and is protected by an absolute black screening to optimize visual comfort while maintaining high performance. Available in different finishes with a double layer of powder coating and chemical conversion surface treatment to ensure high resistance against corrosion. Installation is made with a fixing component that allows a fine adjustment. Double cable gland installed directly in the body of the luminaire for inlet and outlet connection.

Pointbreak Bollard 1 - 300

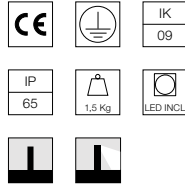
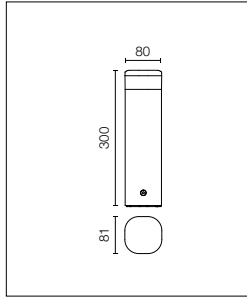

Source de lumière LED incluse.
Alimentation électrique intégrée
220-240V ON/OFF et réglable
1-10V ou DALI. Équipé d'un
câble de sortie en néoprène. Le
système de jonction IP68 doit
être commandé séparément. Le
luminaire peut être facilement
installé sur tout type de sol à l'aide
de chevilles. La plaque d'ancrage
pour l'installation au sol à bétonner
doit être commandée séparément.

LED light source included.
Integrated 220-240V ON/OFF
and 1-10V/DALI dimmable
electrical power. Equipped with
one piece of neoprene output
cable. IP68 junction system to be
ordered separately. The luminaire
may be easily installed on any
type of floor with anchors. The
anchoring plate for installation on
flooring to be concreted must be
ordered separately.

2200K disponible sur demande.

2200K available on request.

Mid - Power Led: 5,6W - 576 lm ≠ FIXT 274 lm - 2700K/CRI>80 - 220-240V / 5,6W - 600 lm ≠ FIXT 285 lm - 3000K/CRI>80 - 220-240V / 5,6W - 625 lm ≠ FIXT 307 lm - 4000/CRI>80 - 220-240V

2700K

Non Dimmable

○ F023E2AA001	614,00 €
● F023E2AA006	614,00 €
● F023E2AA012	614,00 €
● F023E2AA018	614,00 €
● F023E2AA030	614,00 €
● F023E2AA033	614,00 €
1-10V	
○ F023E2AB001	721,00 €
● F023E2AB006	721,00 €
● F023E2AB012	721,00 €
● F023E2AB018	721,00 €
● F023E2AB030	721,00 €
● F023E2AB033	721,00 €
Dali	
○ F023E2AD001	721,00 €
● F023E2AD006	721,00 €
● F023E2AD012	721,00 €
● F023E2AD018	721,00 €
● F023E2AD030	721,00 €
● F023E2AD033	721,00 €

3000K

Non Dimmable

○ F023E3AA001	614,00 €
● F023E3AA006	614,00 €
● F023E3AA012	614,00 €
● F023E3AA018	614,00 €
● F023E3AA030	614,00 €
● F023E3AA033	614,00 €
1-10V	
○ F023E3AB001	721,00 €
● F023E3AB006	721,00 €
● F023E3AB012	721,00 €
● F023E3AB018	721,00 €
● F023E3AB030	721,00 €
● F023E3AB033	721,00 €
Dali	
○ F023E3AD001	721,00 €
● F023E3AD006	721,00 €
● F023E3AD012	721,00 €
● F023E3AD018	721,00 €
● F023E3AD030	721,00 €
● F023E3AD033	721,00 €

4000K

Non Dimmable

○ F023E4AA001	614,00 €
● F023E4AA006	614,00 €
● F023E4AA012	614,00 €
● F023E4AA018	614,00 €
● F023E4AA030	614,00 €
● F023E4AA033	614,00 €
1-10V	
○ F023E4AB001	721,00 €
● F023E4AB006	721,00 €
● F023E4AB012	721,00 €
● F023E4AB018	721,00 €
● F023E4AB030	721,00 €
● F023E4AB033	721,00 €
Dali	
○ F023E4AD001	721,00 €
● F023E4AD006	721,00 €
● F023E4AD012	721,00 €
● F023E4AD018	721,00 €
● F023E4AD030	721,00 €
● F023E4AD033	721,00 €

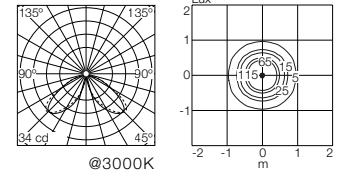

Pointbreak Bollard 1 - 600

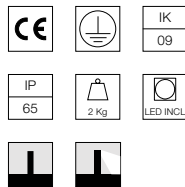
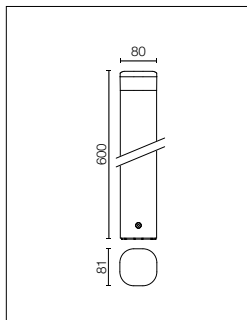

Source de lumière LED incluse.
Alimentation électrique intégrée
220-240V ON/OFF et réglable
1-10V ou DALI. Équipé d'un
câble de sortie en néoprène. Le
système de jonction IP68 doit
être commandé séparément. Le
luminaire peut être facilement
installé sur tout type de sol à l'aide
de chevilles. La plaque d'ancrage
pour l'installation au sol à bétonner
doit être commandée séparément.

LED light source included.
Integrated 220-240V ON/OFF
and 1-10V/DALI dimmable
electrical power. Equipped with
one piece of neoprene output
cable. IP68 junction system to be
ordered separately. The luminaire
may be easily installed on any
type of floor with anchors. The
anchoring plate for installation on
flooring to be concreted must be
ordered separately.

2200K disponible sur demande.

2200K available on request.

Mid - Power Led: 5,6W - 576 lm ≠ FIXT 274 lm - 2700K/CRI>80 - 220-240V / 5,6W - 600 lm ≠ FIXT 285 lm - 3000K/CRI>80 - 220-240V / 5,6W - 625 lm ≠ FIXT 307 lm - 4000/CRI>80 - 220-240V

2700K

Non Dimmable

○ F023E2BA001	660,00 €
● F023E2BA006	660,00 €
● F023E2BA012	660,00 €
● F023E2BA018	660,00 €
● F023E2BA030	660,00 €
● F023E2BA033	660,00 €
1-10V	
○ F023E2BB001	768,00 €
● F023E2BB006	768,00 €
● F023E2BB012	768,00 €
● F023E2BB018	768,00 €
● F023E2BB030	768,00 €
● F023E2BB033	768,00 €
Dali	
○ F023E2BD001	768,00 €
● F023E2BD006	768,00 €
● F023E2BD012	768,00 €
● F023E2BD018	768,00 €
● F023E2BD030	768,00 €
● F023E2BD033	768,00 €

3000K

Non Dimmable

○ F023E3BA001	660,00 €
● F023E3BA006	660,00 €
● F023E3BA012	660,00 €
● F023E3BA018	660,00 €
● F023E3BA030	660,00 €
● F023E3BA033	660,00 €
1-10V	
○ F023E3BB001	768,00 €
● F023E3BB006	768,00 €
● F023E3BB012	768,00 €
● F023E3BB018	768,00 €
● F023E3BB030	768,00 €
● F023E3BB033	768,00 €
Dali	
○ F023E3BD001	768,00 €
● F023E3BD006	768,00 €
● F023E3BD012	768,00 €
● F023E3BD018	768,00 €
● F023E3BD030	768,00 €
● F023E3BD033	768,00 €

4000K

Non Dimmable

○ F023E4BA001	660,00 €
● F023E4BA006	660,00 €
● F023E4BA012	660,00 €
● F023E4BA018	660,00 €
● F023E4BA030	660,00 €
● F023E4BA033	660,00 €
1-10V	
○ F023E4BB001	768,00 €
● F023E4BB006	768,00 €
● F023E4BB012	768,00 €
● F023E4BB018	768,00 €
● F023E4BB030	768,00 €
● F023E4BB033	768,00 €
Dali	
○ F023E4BD001	768,00 €
● F023E4BD006	768,00 €
● F023E4BD012	768,00 €
● F023E4BD018	768,00 €
● F023E4BD030	768,00 €
● F023E4BD033	768,00 €

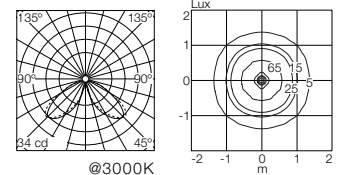

Pointbreak Bollard 1 - 900

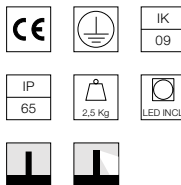
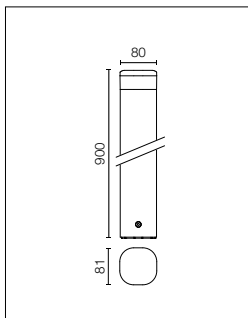

Source de lumière LED incluse. Alimentation électrique intégrée 220-240V ON/OFF et réglable 1-10V ou DALI. Équipé d'un câble de sortie en néoprène. Le système de jonction IP68 doit être commandé séparément. Le luminaire peut être facilement installé sur tout type de sol à l'aide de chevilles. La plaque d'ancrage pour l'installation au sol à bétonner doit être commandée séparément.

LED light source included. Integrated 220-240V ON/OFF and 1-10V/DALI dimmable electrical power. Equipped with one piece of neoprene output cable. IP68 junction system to be ordered separately. The luminaire may be easily installed on any type of floor with anchors. The anchoring plate for installation on flooring to be concreted must be ordered separately.

2200K disponible sur demande.

2200K available on request.

Mid - Power Led: 5,6W - 576 lm ≠ FIXT 274 lm - 2700K/CRI>80 - 220-240V / 5,6W - 600 lm ≠ FIXT 285 lm - 3000K/CRI>80 - 220-240V / 5,6W - 625 lm ≠ FIXT 307 lm - 4000K/CRI>80 - 220-240V

2700K

Non Dimmable

○ F023E2CA001	719,00 €
● F023E2CA006	719,00 €
● F023E2CA012	719,00 €
● F023E2CA018	719,00 €
● F023E2CA030	719,00 €
● F023E2CA033	719,00 €
1-10V	
○ F023E2CB001	827,00 €
● F023E2CB006	827,00 €
● F023E2CB012	827,00 €
● F023E2CB018	827,00 €
● F023E2CB030	827,00 €
● F023E2CB033	827,00 €
Dali	
○ F023E2CD001	827,00 €
● F023E2CD006	827,00 €
● F023E2CD012	827,00 €
● F023E2CD018	827,00 €
● F023E2CD030	827,00 €
● F023E2CD033	827,00 €

3000K

Non Dimmable

○ F023E3CA001	719,00 €
● F023E3CA006	719,00 €
● F023E3CA012	719,00 €
● F023E3CA018	719,00 €
● F023E3CA030	719,00 €
● F023E3CA033	719,00 €
1-10V	
○ F023E3CB001	827,00 €
● F023E3CB006	827,00 €
● F023E3CB012	827,00 €
● F023E3CB018	827,00 €
● F023E3CB030	827,00 €
● F023E3CB033	827,00 €
Dali	
○ F023E3CD001	827,00 €
● F023E3CD006	827,00 €
● F023E3CD012	827,00 €
● F023E3CD018	827,00 €
● F023E3CD030	827,00 €
● F023E3CD033	827,00 €

4000K

Non Dimmable

○ F023E4CA001	719,00 €
● F023E4CA006	719,00 €
● F023E4CA012	719,00 €
● F023E4CA018	719,00 €
● F023E4CA030	719,00 €
● F023E4CA033	719,00 €
1-10V	
○ F023E4CB001	827,00 €
● F023E4CB006	827,00 €
● F023E4CB012	827,00 €
● F023E4CB018	827,00 €
● F023E4CB030	827,00 €
● F023E4CB033	827,00 €
Dali	
○ F023E4CD001	827,00 €
● F023E4CD006	827,00 €
● F023E4CD012	827,00 €
● F023E4CD018	827,00 €
● F023E4CD030	827,00 €
● F023E4CD033	827,00 €

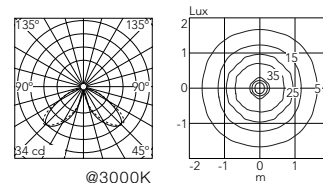

Pointbreak Mono Emission 180°

Pointbreak Bollard est également disponible en version à émission unique (180°) grâce à un obturateur de forme spéciale intégré dans le bloc optique étanche.

Pointbreak Bollard is also available as a single-emission version (180°) thanks to a special shaped shutter integrated in the watertight optical unit.



Sur demande, l'émission lumineuse peut être modifiée à 90° ou 270°.

On request, the beam can be modified to 90° or 270°.



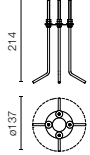

* Spécifications techniques et photométries préliminaires. / Preliminary technical specs and photometries.

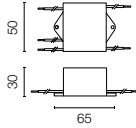
Pointbreak: Accessoires / Accessories

Plaque de boulons.	Base plate with bolt.	Pointbreak Bollard 1 F023Z050000	36,00 €		
Dispositif de protection contre les surtensions. 275Vac. Courant de décharge maximal 10KA (8/20us). Courant de fonctionnement maximal 5A. Adapté pour les connexions en séries. IP66.	Surge protection device. 275Vac. Maximum discharge current 10KA (8/20us). Maximum operating current 5A. Suitable for series connection. IP66.	Pointbreak Bollard F990E00A000	116,00 €		

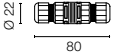
Pointbreak: Accessoires pour les versions non dimmables / Accessories for non-dimmable versions

Système de jonction IP68 H2O Stop anti-condensation à 2 voies 4 pôles.	2 way terminal block 4 poles IP68 H2O Stop.	F990C00A000	33,00 €		
Système de jonction IP68 H2O Stop anti-condensation à 3/4 voies 4 pôles. (Ø5,5÷12mm câble).	3/4 way terminal block 4 poles IP68 H2O Stop. (Ø5,5÷12mm cable).	F990C010000	60,00 €		

Pointbreak: Accessoires pour les versions dimmables / Accessories for dimmable versions

Kit de connecteurs à 5 pôles: fiche volante + fiche EU IP68.	Connector kit 5-pole flying socket + EU plug IP68.	F990C080000	48,00 €		
Boitier de dérivation 5 pôles 4 voies (câbles 6-14 mm).	4 way junction box 5 poles IP68 (6-14 mm cables).	F990C030000	62,00 €		

Pointbreak Bollard 2 - 300

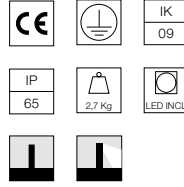
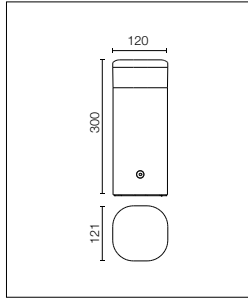

Source de lumière LED incluse. Alimentation électrique intégrée 220-240V ON/OFF et réglable 1-10V ou DALI. Équipé d'un câble de sortie en néoprène. Le système de jonction IP68 doit être commandé séparément. Le luminaire peut être facilement installé sur tout type de sol à l'aide de chevilles. La plaque d'ancrage pour l'installation au sol à bétonner doit être commandée séparément.

LED light source included. Integrated 220-240V ON/OFF and 1-10V/DALI dimmable electrical power. Equipped with one piece of neoprene output cable. IP68 junction system to be ordered separately. The luminaire may be easily installed on any type of floor with anchors. The anchoring plate for installation on flooring to be concreted must be ordered separately.

2200K disponible sur demande.

2200K available on request.

Mid - Power Led: 12,5W - 1374 lm ≠ FIXT 600 lm - 2700K/CRI>80 - 220-240V / 12,5W - 1429 lm ≠ FIXT 624 lm - 3000K/CRI>80 - 220-240V / 12,5W - 1538 lm ≠ FIXT 672 lm - 4000/CRI>80 - 220-240V

2700K

Non Dimmable

○ F023F2AA001	719,00 €
● F023F2AA006	719,00 €
● F023F2AA012	719,00 €
● F023F2AA018	719,00 €
● F023F2AA030	719,00 €
● F023F2AA033	719,00 €
1-10V	
○ F023F2AB001	827,00 €
● F023F2AB006	827,00 €
● F023F2AB012	827,00 €
● F023F2AB018	827,00 €
● F023F2AB030	827,00 €
● F023F2AB033	827,00 €
Dali	
○ F023F2AD001	827,00 €
● F023F2AD006	827,00 €
● F023F2AD012	827,00 €
● F023F2AD018	827,00 €
● F023F2AD030	827,00 €
● F023F2AD033	827,00 €

3000K

Non Dimmable

○ F023F3AA001	719,00 €
● F023F3AA006	719,00 €
● F023F3AA012	719,00 €
● F023F3AA018	719,00 €
● F023F3AA030	719,00 €
● F023F3AA033	719,00 €
1-10V	
○ F023F3AB001	827,00 €
● F023F3AB006	827,00 €
● F023F3AB012	827,00 €
● F023F3AB018	827,00 €
● F023F3AB030	827,00 €
● F023F3AB033	827,00 €
Dali	
○ F023F3AD001	827,00 €
● F023F3AD006	827,00 €
● F023F3AD012	827,00 €
● F023F3AD018	827,00 €
● F023F3AD030	827,00 €
● F023F3AD033	827,00 €

4000K

Non Dimmable

○ F023F4AA001	719,00 €
● F023F4AA006	719,00 €
● F023F4AA012	719,00 €
● F023F4AA018	719,00 €
● F023F4AA030	719,00 €
● F023F4AA033	719,00 €
1-10V	
○ F023F4AB001	827,00 €
● F023F4AB006	827,00 €
● F023F4AB012	827,00 €
● F023F4AB018	827,00 €
● F023F4AB030	827,00 €
● F023F4AB033	827,00 €
Dali	
○ F023F4AD001	827,00 €
● F023F4AD006	827,00 €
● F023F4AD012	827,00 €
● F023F4AD018	827,00 €
● F023F4AD030	827,00 €
● F023F4AD033	827,00 €

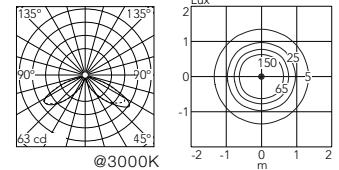

Pointbreak Bollard 2 - 600

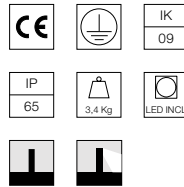
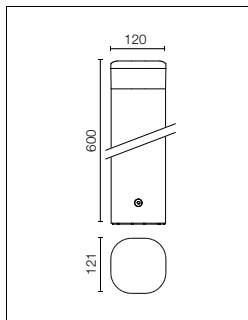

Source de lumière LED incluse. Alimentation électrique intégrée 220-240V ON/OFF et réglable 1-10V ou DALI. Équipé d'un câble de sortie en néoprène. Le système de jonction IP68 doit être commandé séparément. Le luminaire peut être facilement installé sur tout type de sol à l'aide de chevilles. La plaque d'ancrage pour l'installation au sol à bétonner doit être commandée séparément.

LED light source included. Integrated 220-240V ON/OFF and 1-10V/DALI dimmable electrical power. Equipped with one piece of neoprene output cable. IP68 junction system to be ordered separately. The luminaire may be easily installed on any type of floor with anchors. The anchoring plate for installation on flooring to be concreted must be ordered separately.

2200K disponible sur demande.

2200K available on request.

Mid - Power Led: 12,5W - 1374 lm ≠ FIXT 600 lm - 2700K/CRI>80 - 220-240V / 12,5W - 1429 lm ≠ FIXT 624 lm - 3000K/CRI>80 - 220-240V / 12,5W - 1538 lm ≠ FIXT 672 lm - 4000/CRI>80 - 220-240V

2700K

Non Dimmable

○ F023F2BA001	765,00 €
● F023F2BA006	765,00 €
● F023F2BA012	765,00 €
● F023F2BA018	765,00 €
● F023F2BA030	765,00 €
● F023F2BA033	765,00 €
1-10V	
○ F023F2BB001	874,00 €
● F023F2BB006	874,00 €
● F023F2BB012	874,00 €
● F023F2BB018	874,00 €
● F023F2BB030	874,00 €
● F023F2BB033	874,00 €
Dali	
○ F023F2BD001	874,00 €
● F023F2BD006	874,00 €
● F023F2BD012	874,00 €
● F023F2BD018	874,00 €
● F023F2BD030	874,00 €
● F023F2BD033	874,00 €

3000K

Non Dimmable

○ F023F3BA001	765,00 €
● F023F3BA006	765,00 €
● F023F3BA012	765,00 €
● F023F3BA018	765,00 €
● F023F3BA030	765,00 €
● F023F3BA033	765,00 €
1-10V	
○ F023F3BB001	874,00 €
● F023F3BB006	874,00 €
● F023F3BB012	874,00 €
● F023F3BB018	874,00 €
● F023F3BB030	874,00 €
● F023F3BB033	874,00 €
Dali	
○ F023F3BD001	874,00 €
● F023F3BD006	874,00 €
● F023F3BD012	874,00 €
● F023F3BD018	874,00 €
● F023F3BD030	874,00 €
● F023F3BD033	874,00 €

4000K

Non Dimmable

○ F023F4BA001	765,00 €
● F023F4BA006	765,00 €
● F023F4BA012	765,00 €
● F023F4BA018	765,00 €
● F023F4BA030	765,00 €
● F023F4BA033	765,00 €
1-10V	
○ F023F4BB001	874,00 €
● F023F4BB006	874,00 €
● F023F4BB012	874,00 €
● F023F4BB018	874,00 €
● F023F4BB030	874,00 €
● F023F4BB033	874,00 €
Dali	
○ F023F4BD001	874,00 €
● F023F4BD006	874,00 €
● F023F4BD012	874,00 €
● F023F4BD018	874,00 €
● F023F4BD030	874,00 €
● F023F4BD033	874,00 €

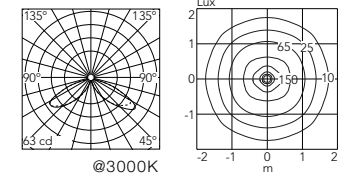

Pointbreak Bollard 2 - 900

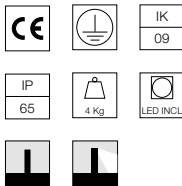
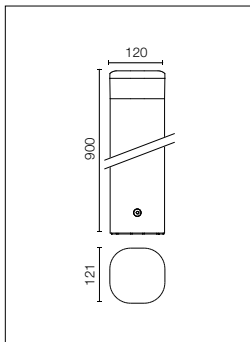

Source de lumière LED incluse. Alimentation électrique intégrée 220-240V ON/OFF et réglable 1-10V ou DALI. Équipé d'un câble de sortie en néoprène. Le système de jonction IP68 doit être commandé séparément. Le luminaire peut être facilement installé sur tout type de sol à l'aide de chevilles. La plaque d'ancrage pour l'installation au sol à bétonner doit être commandée séparément.

LED light source included. Integrated 220-240V ON/OFF and 1-10V/DALI dimmable electrical power. Equipped with one piece of neoprene output cable. IP68 junction system to be ordered separately. The luminaire may be easily installed on any type of floor with anchors. The anchoring plate for installation on flooring to be concreted must be ordered separately.

2200K disponible sur demande.

2200K available on request.

Mid - Power Led: 12,5W - 1374 lm ≠ FIXT 600 lm - 2700K/CRI>80 - 220-240V / 12,5W - 1429 lm ≠ FIXT 624 lm - 3000K/CRI>80 - 220-240V / 12,5W - 1538 lm ≠ FIXT 672 lm - 4000/CRI>80 - 220-240V

2700K

Non Dimmable

○ F023F2CA001	824,00 €
● F023F2CA006	824,00 €
● F023F2CA012	824,00 €
● F023F2CA018	824,00 €
● F023F2CA030	824,00 €
● F023F2CA033	824,00 €
1-10V	
○ F023F2CB001	933,00 €
● F023F2CB006	933,00 €
● F023F2CB012	933,00 €
● F023F2CB018	933,00 €
● F023F2CB030	933,00 €
● F023F2CB033	933,00 €
Dali	
○ F023F2CD001	933,00 €
● F023F2CD006	933,00 €
● F023F2CD012	933,00 €
● F023F2CD018	933,00 €
● F023F2CD030	933,00 €
● F023F2CD033	933,00 €

3000K

Non Dimmable

○ F023F3CA001	824,00 €
● F023F3CA006	824,00 €
● F023F3CA012	824,00 €
● F023F3CA018	824,00 €
● F023F3CA030	824,00 €
● F023F3CA033	824,00 €
1-10V	
○ F023F3CB001	933,00 €
● F023F3CB006	933,00 €
● F023F3CB012	933,00 €
● F023F3CB018	933,00 €
● F023F3CB030	933,00 €
● F023F3CB033	933,00 €
Dali	
○ F023F3CD001	933,00 €
● F023F3CD006	933,00 €
● F023F3CD012	933,00 €
● F023F3CD018	933,00 €
● F023F3CD030	933,00 €
● F023F3CD033	933,00 €

4000K

Non Dimmable

○ F023F4CA001	824,00 €
● F023F4CA006	824,00 €
● F023F4CA012	824,00 €
● F023F4CA018	824,00 €
● F023F4CA030	824,00 €
● F023F4CA033	824,00 €
1-10V	
○ F023F4CB001	933,00 €
● F023F4CB006	933,00 €
● F023F4CB012	933,00 €
● F023F4CB018	933,00 €
● F023F4CB030	933,00 €
● F023F4CB033	933,00 €
Dali	
○ F023F4CD001	933,00 €
● F023F4CD006	933,00 €
● F023F4CD012	933,00 €
● F023F4CD018	933,00 €
● F023F4CD030	933,00 €
● F023F4CD033	933,00 €

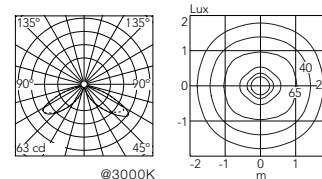

Pointbreak Mono Emission 180°

Pointbreak Bollard est également disponible en version à émission unique (180°) grâce à un obturateur de forme spéciale intégré dans le bloc optique étanche.



Pointbreak Bollard is also available as a single-emission version (180°) thanks to a special shaped shutter integrated in the watertight optical unit.

Sur demande, l'émission lumineuse peut être modifiée à 90° ou 270°.

On request, the beam can be modified to 90° or 270°.

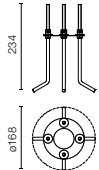

Pointbreak: Accessoires / Accessories

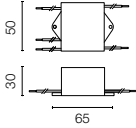
Plaque de boulons.	Base plate with bolt.	Pointbreak Bollard 2 F023Z060000	36,00 €		
Dispositif de protection contre les surtensions. 275Vac. Courant de décharge maximal 10KA (8/20us). Courant de fonctionnement maximal 5A. Adapté pour les connexions en séries. IP66.	Surge protection device. 275Vac. Maximum discharge current 10KA (8/20us). Maximum operating current 5A. Suitable for series connection. IP66.	Pointbreak Bollard F990E00A000	116,00 €		

Pointbreak: Accessoires pour les versions non dimmables / Accessories for non-dimmable versions

Système de jonction IP68 H2O Stop anti-condensation à 2 voies 4 pôles.	2 way terminal block 4 poles IP68 H2O Stop.	F990C00A000	33,00 €		
Système de jonction IP68 H2O Stop anti-condensation à 3/4 voies 4 pôles. (Ø5,5÷12mm câble).	3/4 way terminal block 4 poles IP68 H2O Stop. (Ø5,5÷12mm cable).	F990C010000	60,00 €		

Pointbreak: Accessoires pour les versions dimmables / Accessories for dimmable versions

Kit de connecteurs à 5 pôles: fiche volante + fiche EU IP68.	Connector kit 5-pole flying socket + EU plug IP68.	F990C080000	48,00 €		
Boitier de dérivation 5 pôles 4 voies (câbles 6-14 mm).	4 way junction box 5 poles IP68 (6-14 mm cables).	F990C030000	62,00 €		

* Spécifications techniques et photométries préliminaires. / Preliminary technical specs and photometries.

Pointbreak Balisage 1 - 40

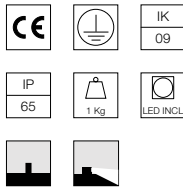
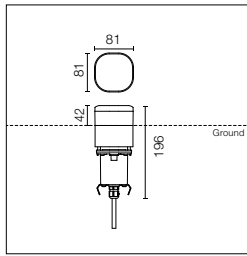

Source de lumière LED incluse. Alimentation électrique intégrée 220-240V ON/OFF et réglable 1-10V ou DALI. Équipé d'un câble de sortie en néoprène. Le système de jonction IP68 doit être commandé séparément. Le luminaire doit être installé avec un coffrage obligatoire, à commander séparément.

LED light source included. Integrated 220-240V ON/OFF and 1-10V/DALI dimmable electrical power. Equipped with one piece of neoprene output cable. IP68 junction system to be ordered separately. Luminaire must be installed with mandatory box for installation, ordered separately.

2200K disponible sur demande.

2200K available on request.

Mid - Power Led: 5,6W - 576 lm ≠ FIXT 274 lm - 2700K/CRI>80 - 220-240V / 5,6W - 600 lm ≠ FIXT 285 lm - 3000K/CRI>80 - 220-240V / 5,6W - 625 lm ≠ FIXT 307 lm - 4000/CRI>80 - 220-240V

2700K

Non Dimmable

○ F023B2AA001	589,00 €
● F023B2AA006	589,00 €
● F023B2AA012	589,00 €
● F023B2AA018	589,00 €
● F023B2AA030	589,00 €
● F023B2AA033	589,00 €
1-10V	
○ F023B2AB001	697,00 €
● F023B2AB006	697,00 €
● F023B2AB012	697,00 €
● F023B2AB018	697,00 €
● F023B2AB030	697,00 €
● F023B2AB033	697,00 €
Dali	
○ F023B2AD001	697,00 €
● F023B2AD006	697,00 €
● F023B2AD012	697,00 €
● F023B2AD018	697,00 €
● F023B2AD030	697,00 €
● F023B2AD033	697,00 €

3000K

Non Dimmable

○ F023B3AA001	589,00 €
● F023B3AA006	589,00 €
● F023B3AA012	589,00 €
● F023B3AA018	589,00 €
● F023B3AA030	589,00 €
● F023B3AA033	589,00 €
1-10V	
○ F023B3AB001	697,00 €
● F023B3AB006	697,00 €
● F023B3AB012	697,00 €
● F023B3AB018	697,00 €
● F023B3AB030	697,00 €
● F023B3AB033	697,00 €
Dali	
○ F023B3AD001	697,00 €
● F023B3AD006	697,00 €
● F023B3AD012	697,00 €
● F023B3AD018	697,00 €
● F023B3AD030	697,00 €
● F023B3AD033	697,00 €

4000K

Non Dimmable

○ F023B4AA001	589,00 €
● F023B4AA006	589,00 €
● F023B4AA012	589,00 €
● F023B4AA018	589,00 €
● F023B4AA030	589,00 €
● F023B4AA033	589,00 €
1-10V	
○ F023B4AB001	697,00 €
● F023B4AB006	697,00 €
● F023B4AB012	697,00 €
● F023B4AB018	697,00 €
● F023B4AB030	697,00 €
● F023B4AB033	697,00 €
Dali	
○ F023B4AD001	697,00 €
● F023B4AD006	697,00 €
● F023B4AD012	697,00 €
● F023B4AD018	697,00 €
● F023B4AD030	697,00 €
● F023B4AD033	697,00 €

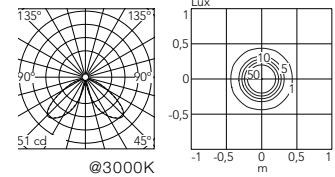

Boitier pour installation au sol / Box for ground installation.

F023Z020000 24,00 €



Pointbreak Balisage 1 - 80

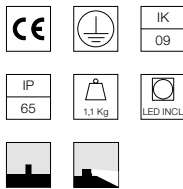
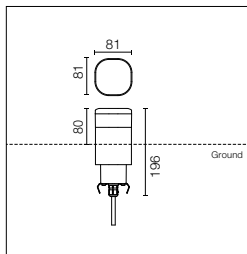

Source de lumière LED incluse. Alimentation électrique intégrée 220-240V ON/OFF et réglable 1-10V ou DALI. Équipé d'un câble de sortie en néoprène. Le système de jonction IP68 doit être commandé séparément. Le luminaire doit être installé avec un coffrage obligatoire, à commander séparément.

LED light source included. Integrated 220-240V ON/OFF and 1-10V/DALI dimmable electrical power. Equipped with one piece of neoprene output cable. IP68 junction system to be ordered separately. Luminaire must be installed with mandatory box for installation, ordered separately.

2200K disponible sur demande.

2200K available on request.

Mid - Power Led: 5,6W - 576 lm ≠ FIXT 274 lm - 2700K/CRI>80 - 220-240V / 5,6W - 600 lm ≠ FIXT 285 lm - 3000K/CRI>80 - 220-240V / 5,6W - 625 lm ≠ FIXT 307 lm - 4000/CRI>80 - 220-240V

2700K

Non Dimmable

○ F023B2BA001	601,00 €
● F023B2BA006	601,00 €
● F023B2BA012	601,00 €
● F023B2BA018	601,00 €
● F023B2BA030	601,00 €
● F023B2BA033	601,00 €
1-10V	
○ F023B2BB001	709,00 €
● F023B2BB006	709,00 €
● F023B2BB012	709,00 €
● F023B2BB018	709,00 €
● F023B2BB030	709,00 €
● F023B2BB033	709,00 €
Dali	
○ F023B2BD001	709,00 €
● F023B2BD006	709,00 €
● F023B2BD012	709,00 €
● F023B2BD018	709,00 €
● F023B2BD030	709,00 €
● F023B2BD033	709,00 €

3000K

Non Dimmable

○ F023B3BA001	601,00 €
● F023B3BA006	601,00 €
● F023B3BA012	601,00 €
● F023B3BA018	601,00 €
● F023B3BA030	601,00 €
● F023B3BA033	601,00 €
1-10V	
○ F023B3BB001	709,00 €
● F023B3BB006	709,00 €
● F023B3BB012	709,00 €
● F023B3BB018	709,00 €
● F023B3BB030	709,00 €
● F023B3BB033	709,00 €
Dali	
○ F023B3BD001	709,00 €
● F023B3BD006	709,00 €
● F023B3BD012	709,00 €
● F023B3BD018	709,00 €
● F023B3BD030	709,00 €
● F023B3BD033	709,00 €

4000K

Non Dimmable

○ F023B4BA001	601,00 €
● F023B4BA006	601,00 €
● F023B4BA012	601,00 €
● F023B4BA018	601,00 €
● F023B4BA030	601,00 €
● F023B4BA033	601,00 €
1-10V	
○ F023B4BB001	709,00 €
● F023B4BB006	709,00 €
● F023B4BB012	709,00 €
● F023B4BB018	709,00 €
● F023B4BB030	709,00 €
● F023B4BB033	709,00 €
Dali	
○ F023B4BD001	709,00 €
● F023B4BD006	709,00 €
● F023B4BD012	709,00 €
● F023B4BD018	709,00 €
● F023B4BD030	709,00 €
● F023B4BD033	709,00 €

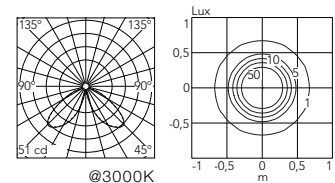

Boitier pour installation au sol / Box for ground installation.

F023Z020000 24,00 €



* Spécifications techniques et photométries préliminaires. / Preliminary technical specs and photometries.

Pointbreak Balisage 2 - 60

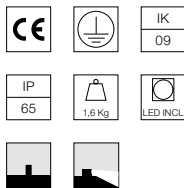
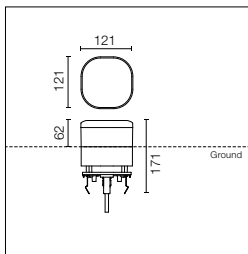

Source de lumière LED incluse. Alimentation électrique intégrée 220-240V ON/OFF et réglable 1-10V ou DALI. Équipé d'un câble de sortie en néoprène. Le système de jonction IP68 doit être commandé séparément. Le luminaire doit être installé avec un coffrage obligatoire, à commander séparément.

LED light source included. Integrated 220-240V ON/OFF and 1-10V/DALI dimmable electrical power. Equipped with one piece of neoprene output cable. IP68 junction system to be ordered separately. Luminaire must be installed with mandatory box for installation, ordered separately.

2200K disponible sur demande.

2200K available on request.

Mid - Power Led: 12,5W - 1374 lm ≠ FIXT 600 lm - 2700K/CRI>80 - 220-240V / 12,5W - 1429 lm ≠ FIXT 624 lm - 3000K/CRI>80 - 220-240V / 12,5W - 1538 lm ≠ FIXT 672 lm - 4000/CRI>80 - 220-240V

2700K

Non Dimmable

○ F023C2CA001	695,00 €
● F023C2CA006	695,00 €
● F023C2CA012	695,00 €
● F023C2CA018	695,00 €
● F023C2CA030	695,00 €
● F023C2CA033	695,00 €
1-10V	
○ F023C2CB001	803,00 €
● F023C2CB006	803,00 €
● F023C2CB012	803,00 €
● F023C2CB018	803,00 €
● F023C2CB030	803,00 €
● F023C2CB033	803,00 €
Dali	
○ F023C2CD001	803,00 €
● F023C2CD006	803,00 €
● F023C2CD012	803,00 €
● F023C2CD018	803,00 €
● F023C2CD030	803,00 €
● F023C2CD033	803,00 €

3000K

Non Dimmable

○ F023C3CA001	695,00 €
● F023C3CA006	695,00 €
● F023C3CA012	695,00 €
● F023C3CA018	695,00 €
● F023C3CA030	695,00 €
● F023C3CA033	695,00 €
1-10V	
○ F023C3CB001	803,00 €
● F023C3CB006	803,00 €
● F023C3CB012	803,00 €
● F023C3CB018	803,00 €
● F023C3CB030	803,00 €
● F023C3CB033	803,00 €
Dali	
○ F023C3CD001	803,00 €
● F023C3CD006	803,00 €
● F023C3CD012	803,00 €
● F023C3CD018	803,00 €
● F023C3CD030	803,00 €
● F023C3CD033	803,00 €

4000K

Non Dimmable

○ F023C4CA001	695,00 €
● F023C4CA006	695,00 €
● F023C4CA012	695,00 €
● F023C4CA018	695,00 €
● F023C4CA030	695,00 €
● F023C4CA033	695,00 €
1-10V	
○ F023C4CB001	803,00 €
● F023C4CB006	803,00 €
● F023C4CB012	803,00 €
● F023C4CB018	803,00 €
● F023C4CB030	803,00 €
● F023C4CB033	803,00 €
Dali	
○ F023C4CD001	803,00 €
● F023C4CD006	803,00 €
● F023C4CD012	803,00 €
● F023C4CD018	803,00 €
● F023C4CD030	803,00 €
● F023C4CD033	803,00 €

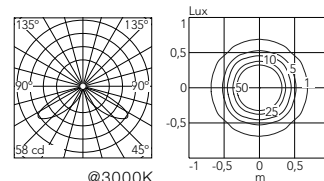

Boîtier pour installation au sol / Box for ground installation.

F023Z030000 26,00 €



Pointbreak Balisage 2 - 105

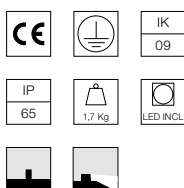
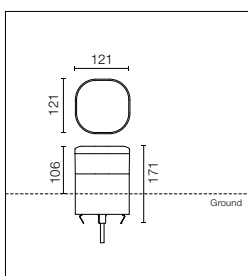

Source de lumière LED incluse. Alimentation électrique intégrée 220-240V ON/OFF et réglable 1-10V ou DALI. Équipé d'un câble de sortie en néoprène. Le système de jonction IP68 doit être commandé séparément. Le luminaire doit être installé avec un coffrage obligatoire, à commander séparément.

LED light source included. Integrated 220-240V ON/OFF and 1-10V/DALI dimmable electrical power. Equipped with one piece of neoprene output cable. IP68 junction system to be ordered separately. Luminaire must be installed with mandatory box for installation, ordered separately.

2200K disponible sur demande.

2200K available on request.

Mid - Power Led: 12,5W - 1374 lm ≠ FIXT 600 lm - 2700K/CRI>80 - 220-240V / 12,5W - 1429 lm ≠ FIXT 624 lm - 3000K/CRI>80 - 220-240V / 12,5W - 1538 lm ≠ FIXT 672 lm - 4000/CRI>80 - 220-240V

2700K

Non Dimmable

○ F023C2DA001	706,00 €
● F023C2DA006	706,00 €
● F023C2DA012	706,00 €
● F023C2DA018	706,00 €
● F023C2DA030	706,00 €
● F023C2DA033	706,00 €
1-10V	
○ F023C2DB001	816,00 €
● F023C2DB006	816,00 €
● F023C2DB012	816,00 €
● F023C2DB018	816,00 €
● F023C2DB030	816,00 €
● F023C2DB033	816,00 €
Dali	
○ F023C2DD001	816,00 €
● F023C2DD006	816,00 €
● F023C2DD012	816,00 €
● F023C2DD018	816,00 €
● F023C2DD030	816,00 €
● F023C2DD033	816,00 €

3000K

Non Dimmable

○ F023C3DA001	706,00 €
● F023C3DA006	706,00 €
● F023C3DA012	706,00 €
● F023C3DA018	706,00 €
● F023C3DA030	706,00 €
● F023C3DA033	706,00 €
1-10V	
○ F023C3DB001	816,00 €
● F023C3DB006	816,00 €
● F023C3DB012	816,00 €
● F023C3DB018	816,00 €
● F023C3DB030	816,00 €
● F023C3DB033	816,00 €
Dali	
○ F023C3DD001	816,00 €
● F023C3DD006	816,00 €
● F023C3DD012	816,00 €
● F023C3DD018	816,00 €
● F023C3DD030	816,00 €
● F023C3DD033	816,00 €

4000K

Non Dimmable

○ F023C4DA001	706,00 €
● F023C4DA006	706,00 €
● F023C4DA012	706,00 €
● F023C4DA018	706,00 €
● F023C4DA030	706,00 €
● F023C4DA033	706,00 €
1-10V	
○ F023C4DB001	816,00 €
● F023C4DB006	816,00 €
● F023C4DB012	816,00 €
● F023C4DB018	816,00 €
● F023C4DB030	816,00 €
● F023C4DB033	816,00 €
Dali	
○ F023C4DD001	816,00 €
● F023C4DD006	816,00 €
● F023C4DD012	816,00 €
● F023C4DD018	816,00 €
● F023C4DD030	816,00 €
● F023C4DD033	816,00 €

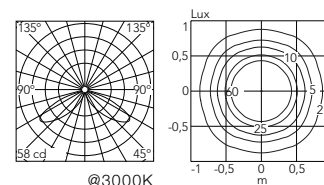

Boîtier pour installation au sol. / Box for ground installation.

F023Z040000 38,00 €



* Spécifications techniques et photométries préliminaires. / Preliminary technical specs and photometries.

Pointbreak Wall 0 Up

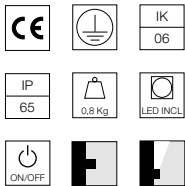
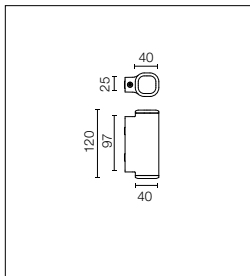

Source de lumière LED incluse.
Source d'alimentation intégrée
220-240V ON/OFF. Équipé d'un
passe-fil en caoutchouc IP65 et
de bornes de connexion rapide
à 2 pôles.

LED light source included.
Integrated 220-240V ON/OFF
electrical power. Equipped
with IP65 rubber grommet and
2-pole quick-connect terminals.

2200K disponible sur demande.

2200K available on request.

Optic Spot

Power Led: 2,1W - 139 lm ≠ *FIXT 101 lm - 2700K/CRI>80 - 220-240V / 2,1W - 149 lm ≠ *FIXT 104 lm - 3000K/CRI>80 - 220-240V / 2,1W - 154 lm ≠ *FIXT 108 lm - 4000/CRI>80 - 220-240V
*FIXT lm = Spot Optic

2700K

Non Dimmable

○ F023G2EA001	301,00 €
● F023G2EA006	301,00 €
● F023G2EA012	301,00 €
● F023G2EA018	301,00 €
● F023G2EA030	301,00 €
● F023G2EA033	301,00 €

3000K

Non Dimmable

○ F023G3EA001	301,00 €
● F023G3EA006	301,00 €
● F023G3EA012	301,00 €
● F023G3EA018	301,00 €
● F023G3EA030	301,00 €
● F023G3EA033	301,00 €

4000K

Non Dimmable

○ F023G4EA001	301,00 €
● F023G4EA006	301,00 €
● F023G4EA012	301,00 €
● F023G4EA018	301,00 €
● F023G4EA030	301,00 €
● F023G4EA033	301,00 €

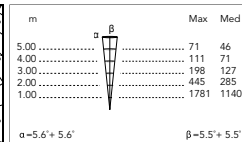
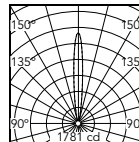

@3000K

Optic Medium

Power Led: 2,1W - 139 lm ≠ *FIXT 102 lm - 2700K/CRI>80 - 220-240V / 2,1W - 149 lm ≠ *FIXT 106 lm - 3000K/CRI>80 - 220-240V / 2,1W - 154 lm ≠ *FIXT 110 lm - 4000/CRI>80 - 220-240V
*FIXT lm = Spot Optic

2700K

Non Dimmable

○ F023G2FA001	301,00 €
● F023G2FA006	301,00 €
● F023G2FA012	301,00 €
● F023G2FA018	301,00 €
● F023G2FA030	301,00 €
● F023G2FA033	301,00 €

3000K

Non Dimmable

○ F023G3FA001	301,00 €
● F023G3FA006	301,00 €
● F023G3FA012	301,00 €
● F023G3FA018	301,00 €
● F023G3FA030	301,00 €
● F023G3FA033	301,00 €

4000K

Non Dimmable

○ F023G4FA001	301,00 €
● F023G4FA006	301,00 €
● F023G4FA012	301,00 €
● F023G4FA018	301,00 €
● F023G4FA030	301,00 €
● F023G4FA033	301,00 €

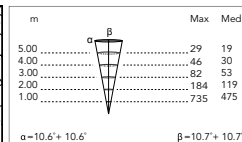
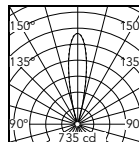

@3000K

Optic Flood

Power Led: 2,1W - 139 lm ≠ *FIXT 101 lm - 2700K/CRI>80 - 220-240V / 2,1W - 149 lm ≠ *FIXT 104 lm - 3000K/CRI>80 - 220-240V / 2,1W - 154 lm ≠ *FIXT 108 lm - 4000/CRI>80 - 220-240V
*FIXT lm = Spot Optic

2700K

Non Dimmable

○ F023G2GA001	301,00 €
● F023G2GA006	301,00 €
● F023G2GA012	301,00 €
● F023G2GA018	301,00 €
● F023G2GA030	301,00 €
● F023G2GA033	301,00 €

3000K

Non Dimmable

○ F023G3GA001	301,00 €
● F023G3GA006	301,00 €
● F023G3GA012	301,00 €
● F023G3GA018	301,00 €
● F023G3GA030	301,00 €
● F023G3GA033	301,00 €

4000K

Non Dimmable

○ F023G4GA001	301,00 €
● F023G4GA006	301,00 €
● F023G4GA012	301,00 €
● F023G4GA018	301,00 €
● F023G4GA030	301,00 €
● F023G4GA033	301,00 €

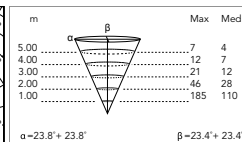
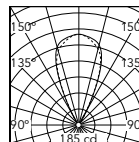

@3000K

Pointbreak Wall 0 Down

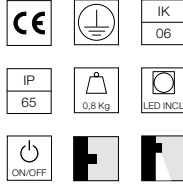
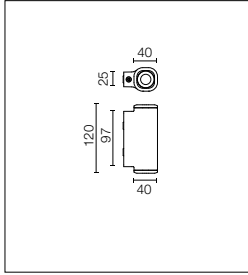

Source de lumière LED incluse.
Source d'alimentation intégrée
220-240V ON/OFF. Équipé d'un
passe-fil en caoutchouc IP65 et
de bornes de connexion rapide
à 2 pôles.

LED light source included.
Integrated 220-240V ON/OFF
electrical power. Equipped
with IP65 rubber grommet and
2-pole quick-connect terminals.

2200K disponible sur demande.

2200K available on request.

Optic Spot

Power Led: 2,1W - 139 lm ≠ *FIXT 101 lm - 2700K/CRI>80 - 220-240V / 2,1W - 149 lm ≠ *FIXT 104 lm - 3000K/CRI>80 - 220-240V / 2,1W - 154 lm ≠

*FIXT 108 lm - 4000/CRI>80 - 220-240V

*FIXT lm = Spot Optic

2700K		3000K		4000K	
Non Dimmable		Non Dimmable		Non Dimmable	
○ F023G2JA001	301,00 €	○ F023G3JA001	301,00 €	○ F023G4JA001	301,00 €
● F023G2JA006	301,00 €	● F023G3JA006	301,00 €	● F023G4JA006	301,00 €
● F023G2JA012	301,00 €	● F023G3JA012	301,00 €	● F023G4JA012	301,00 €
● F023G2JA018	301,00 €	● F023G3JA018	301,00 €	● F023G4JA018	301,00 €
● F023G2JA030	301,00 €	● F023G3JA030	301,00 €	● F023G4JA030	301,00 €
● F023G2JA033	301,00 €	● F023G3JA033	301,00 €	● F023G4JA033	301,00 €

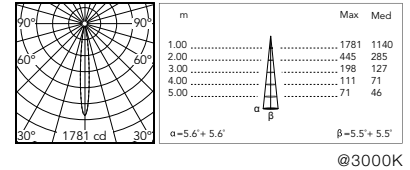

@3000K

Optic Medium

Power Led: 2,1W - 139 lm ≠ *FIXT 102 lm - 2700K/CRI>80 - 220-240V / 2,1W - 149 lm ≠ *FIXT 106 lm - 3000K/CRI>80 - 220-240V / 2,1W - 154 lm ≠

*FIXT 110 lm - 4000/CRI>80 - 220-240V

*FIXT lm = Spot Optic

2700K		3000K		4000K	
Non Dimmable		Non Dimmable		Non Dimmable	
○ F023G2KA001	301,00 €	○ F023G3KA001	301,00 €	○ F023G4KA001	301,00 €
● F023G2KA006	301,00 €	● F023G3KA006	301,00 €	● F023G4KA006	301,00 €
● F023G2KA012	301,00 €	● F023G3KA012	301,00 €	● F023G4KA012	301,00 €
● F023G2KA018	301,00 €	● F023G3KA018	301,00 €	● F023G4KA018	301,00 €
● F023G2KA030	301,00 €	● F023G3KA030	301,00 €	● F023G4KA030	301,00 €
● F023G2KA033	301,00 €	● F023G3KA033	301,00 €	● F023G4KA033	301,00 €

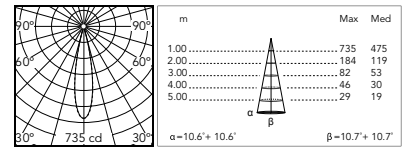

@3000K

Optic Flood

Power Led: 2,1W - 139 lm ≠ *FIXT 101 lm - 2700K/CRI>80 - 220-240V / 2,1W - 149 lm ≠ *FIXT 104 lm - 3000K/CRI>80 - 220-240V / 2,1W - 154 lm ≠

*FIXT 108 lm - 4000/CRI>80 - 220-240V

*FIXT lm = Spot Optic

2700K		3000K		4000K	
Non Dimmable		Non Dimmable		Non Dimmable	
○ F023G2LA001	301,00 €	○ F023G3LA001	301,00 €	○ F023G4LA001	301,00 €
● F023G2LA006	301,00 €	● F023G3LA006	301,00 €	● F023G4LA006	301,00 €
● F023G2LA012	301,00 €	● F023G3LA012	301,00 €	● F023G4LA012	301,00 €
● F023G2LA018	301,00 €	● F023G3LA018	301,00 €	● F023G4LA018	301,00 €
● F023G2LA030	301,00 €	● F023G3LA030	301,00 €	● F023G4LA030	301,00 €
● F023G2LA033	301,00 €	● F023G3LA033	301,00 €	● F023G4LA033	301,00 €

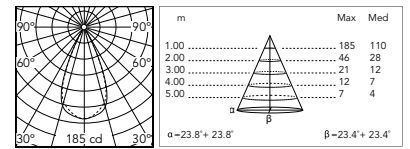

@3000K

Pointbreak Wall 0 Up&Down

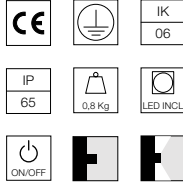
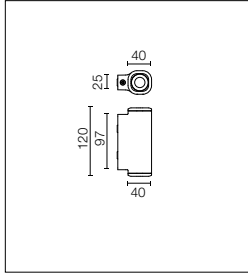

Source de lumière LED incluse.
Source d'alimentation intégrée
220-240V ON/OFF. Équipé d'un
passe-fil en caoutchouc IP65 et
de bornes de connexion rapide
à 2 pôles.

LED light source included.
Integrated 220-240V ON/OFF
electrical power. Equipped
with IP65 rubber grommet and
2-pole quick-connect terminals.

2200K disponible sur demande.

2200K available on request.

Optic Spot

Power Led: 3,1W - 2x139 lm ≠ *FIXT 2x101 lm - 2700K/CRI>80 - 220-240V / 3,1W - 2x149 lm ≠ *FIXT 2x104 lm - 3000K/CRI>80 - 220-240V / 3,1W - 2x154 lm ≠ *FIXT 2x108 lm - 4000/CRI>80 - 220-240V
*FIXT lm = Spot Optic

2700K

Non Dimmable

- F023G25A001 317,00 €
- F023G25A006 317,00 €
- F023G25A012 317,00 €
- F023G25A018 317,00 €
- F023G25A030 317,00 €
- F023G25A033 317,00 €

3000K

Non Dimmable

- F023G35A001 317,00 €
- F023G35A006 317,00 €
- F023G35A012 317,00 €
- F023G35A018 317,00 €
- F023G35A030 317,00 €
- F023G35A033 317,00 €

4000K

Non Dimmable

- F023G45A001 317,00 €
- F023G45A006 317,00 €
- F023G45A012 317,00 €
- F023G45A018 317,00 €
- F023G45A030 317,00 €
- F023G45A033 317,00 €

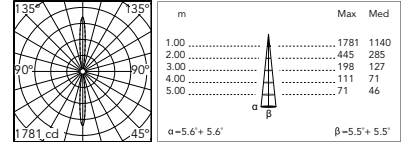

@3000K

Optic Medium

Power Led: 3,1W - 2x139 lm ≠ *FIXT 2x102 lm - 2700K/CRI>80 - 220-240V / 3,1W - 2x149 lm ≠ *FIXT 2x106 lm - 3000K/CRI>80 - 220-240V / 3,1W - 2x154 lm ≠ *FIXT 2x110 lm - 4000/CRI>80 - 220-240V
*FIXT lm = Spot Optic

2700K

Non Dimmable

- F023G26A001 317,00 €
- F023G26A006 317,00 €
- F023G26A012 317,00 €
- F023G26A018 317,00 €
- F023G26A030 317,00 €
- F023G26A033 317,00 €

3000K

Non Dimmable

- F023G36A001 317,00 €
- F023G36A006 317,00 €
- F023G36A012 317,00 €
- F023G36A018 317,00 €
- F023G36A030 317,00 €
- F023G36A033 317,00 €

4000K

Non Dimmable

- F023G46A001 317,00 €
- F023G46A006 317,00 €
- F023G46A012 317,00 €
- F023G46A018 317,00 €
- F023G46A030 317,00 €
- F023G46A033 317,00 €

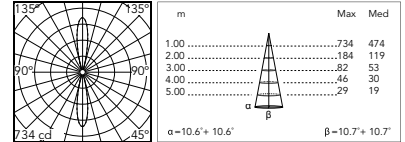

@3000K

Optic Flood

Power Led: 3,1W - 2x139 lm ≠ *FIXT 2x101 lm - 2700K/CRI>80 - 220-240V / 3,1W - 2x149 lm ≠ *FIXT 2x104 lm - 3000K/CRI>80 - 220-240V / 3,1W - 2x154 lm ≠ *FIXT 2x108 lm - 4000/CRI>80 - 220-240V
*FIXT lm = Spot Optic

2700K

Non Dimmable

- F023G27A001 317,00 €
- F023G27A006 317,00 €
- F023G27A012 317,00 €
- F023G27A018 317,00 €
- F023G27A030 317,00 €
- F023G27A033 317,00 €

3000K

Non Dimmable

- F023G37A001 317,00 €
- F023G37A006 317,00 €
- F023G37A012 317,00 €
- F023G37A018 317,00 €
- F023G37A030 317,00 €
- F023G37A033 317,00 €

4000K

Non Dimmable

- F023G47A001 317,00 €
- F023G47A006 317,00 €
- F023G47A012 317,00 €
- F023G47A018 317,00 €
- F023G47A030 317,00 €
- F023G47A033 317,00 €

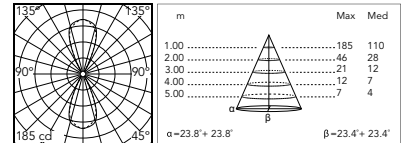

@3000K

* Spécifications techniques préliminaires. / Preliminary technical specs.

Pointbreak Wall 1 Down

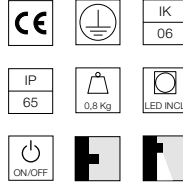
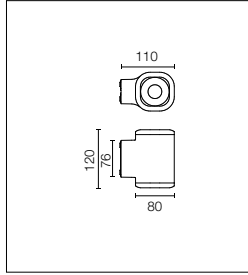

Source de lumière LED incluse.
 Source d'alimentation intégrée 220-240V ON/OFF. Équipé de doubles passe-fils pour la connexion d'entrée et de sortie.
 Version à émission simple vers le haut. Disponible sur demande.

LED light source included.
 Integrated 220-240V ON/OFF electrical power. Equipped with double cable gland for inlet and outlet connection.
 Upwards, single emission version, available upon request.

Optic Spot

Power LED: 5,5W - 543 lm ≠ FIXT 319 lm - 2700K/CRI>80 - 220-240V / 5,5W - 570 lm ≠ FIXT 335 lm - 3000K/CRI>80 - 220-240V / 5,5W - 597 lm ≠ FIXT 367 lm - 4000/CRI>80 - 220-240V

2700K

Non Dimmable

- F023H21A001 355,00 €
- F023H21A006 355,00 €
- F023H21A012 355,00 €
- F023H21A018 355,00 €
- F023H21A030 355,00 €
- F023H21A033 355,00 €

3000K

Non Dimmable

- F023H31A001 355,00 €
- F023H31A006 355,00 €
- F023H31A012 355,00 €
- F023H31A018 355,00 €
- F023H31A030 355,00 €
- F023H31A033 355,00 €

4000K

Non Dimmable

- F023H41A001 355,00 €
- F023H41A006 355,00 €
- F023H41A012 355,00 €
- F023H41A018 355,00 €
- F023H41A030 355,00 €
- F023H41A033 355,00 €

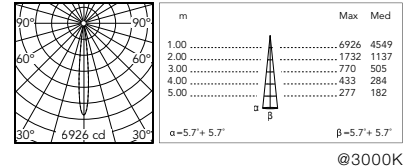

Optic Medium

Power LED: 5,5W - 543 lm ≠ FIXT 350 lm - 2700K/CRI>80 - 220-240V / 5,5W - 570 lm ≠ FIXT 367 lm - 3000K/CRI>80 - 220-240V / 5,5W - 597 lm ≠ FIXT 402 lm - 4000/CRI>80 - 220-240V

2700K

Non Dimmable

- F023H22A001 355,00 €
- F023H22A006 355,00 €
- F023H22A012 355,00 €
- F023H22A018 355,00 €
- F023H22A030 355,00 €
- F023H22A033 355,00 €

3000K

Non Dimmable

- F023H32A001 355,00 €
- F023H32A006 355,00 €
- F023H32A012 355,00 €
- F023H32A018 355,00 €
- F023H32A030 355,00 €
- F023H32A033 355,00 €

4000K

Non Dimmable

- F023H42A001 355,00 €
- F023H42A006 355,00 €
- F023H42A012 355,00 €
- F023H42A018 355,00 €
- F023H42A030 355,00 €
- F023H42A033 355,00 €

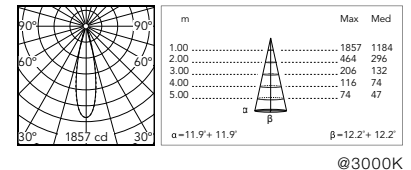

Optic Flood

Power LED: 5,5W - 543 lm ≠ FIXT 311 lm - 2700K/CRI>80 - 220-240V / 5,5W - 570 lm ≠ FIXT 325 lm - 3000K/CRI>80 - 220-240V / 5,5W - 597 lm ≠ FIXT 356 lm - 4000/CRI>80 - 220-240V

2700K

Non Dimmable

- F023H23A001 355,00 €
- F023H23A006 355,00 €
- F023H23A012 355,00 €
- F023H23A018 355,00 €
- F023H23A030 355,00 €
- F023H23A033 355,00 €

3000K

Non Dimmable

- F023H33A001 355,00 €
- F023H33A006 355,00 €
- F023H33A012 355,00 €
- F023H33A018 355,00 €
- F023H33A030 355,00 €
- F023H33A033 355,00 €

4000K

Non Dimmable

- F023H43A001 355,00 €
- F023H43A006 355,00 €
- F023H43A012 355,00 €
- F023H43A018 355,00 €
- F023H43A030 355,00 €
- F023H43A033 355,00 €

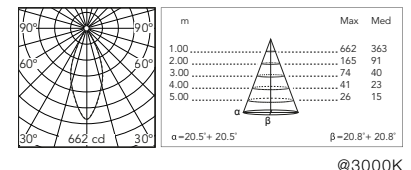

* Spécifications techniques préliminaires. / Preliminary technical specs.

Pointbreak Wall 1 Up&Down

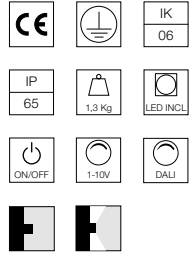
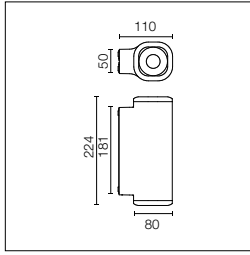

Source de lumière LED incluse.
Alimentation électrique intégrée
220-240V ON/OFF et réglable
1-10V ou DALI.
Équipé de doubles passe-fils
pour la connexion d'entrée et
de sortie.
Sur demande, version à
émission simple vers le haut ou
à émission simple vers le bas.

LED light source included.
Integrated 220-240V ON/OFF
and 1-10V/DALI dimmable
electrical power.
Equipped with double cable
gland for inlet and outlet
connection.
Upon request: Single upwards
emission or single downwards
emission.

Optic Spot

Power Led: 12W - 2x543 lm ≠ FIXT 2x319 lm - 2700K/CRI>80 - 220-240V / 12W - 2x570 lm ≠ FIXT 2x335 lm - 3000K/CRI>80 - 220-240V / 12W - 2x597 lm ≠ FIXT 2x367 lm - 4000/CRI>80 - 220-240V

2700K

Non Dimmable

○ F023H25A001	479,00 €
● F023H25A006	479,00 €
● F023H25A012	479,00 €
● F023H25A018	479,00 €
● F023H25A030	479,00 €
● F023H25A033	479,00 €
1-10V	
○ F023H25B001	578,00 €
● F023H25B006	578,00 €
● F023H25B012	578,00 €
● F023H25B018	578,00 €
● F023H25B030	578,00 €
● F023H25B033	578,00 €
Dali	
○ F023H25D001	578,00 €
● F023H25D006	578,00 €
● F023H25D012	578,00 €
● F023H25D018	578,00 €
● F023H25D030	578,00 €
● F023H25D033	578,00 €

3000K

Non Dimmable

○ F023H35A001	479,00 €
● F023H35A006	479,00 €
● F023H35A012	479,00 €
● F023H35A018	479,00 €
● F023H35A030	479,00 €
● F023H35A033	479,00 €
1-10V	
○ F023H35B001	578,00 €
● F023H35B006	578,00 €
● F023H35B012	578,00 €
● F023H35B018	578,00 €
● F023H35B030	578,00 €
● F023H35B033	578,00 €
Dali	
○ F023H35D001	578,00 €
● F023H35D006	578,00 €
● F023H35D012	578,00 €
● F023H35D018	578,00 €
● F023H35D030	578,00 €
● F023H35D033	578,00 €

4000K

Non Dimmable

○ F023H45A001	479,00 €
● F023H45A006	479,00 €
● F023H45A012	479,00 €
● F023H45A018	479,00 €
● F023H45A030	479,00 €
● F023H45A033	479,00 €
1-10V	
○ F023H45B001	578,00 €
● F023H45B006	578,00 €
● F023H45B012	578,00 €
● F023H45B018	578,00 €
● F023H45B030	578,00 €
● F023H45B033	578,00 €
Dali	
○ F023H45D001	578,00 €
● F023H45D006	578,00 €
● F023H45D012	578,00 €
● F023H45D018	578,00 €
● F023H45D030	578,00 €
● F023H45D033	578,00 €

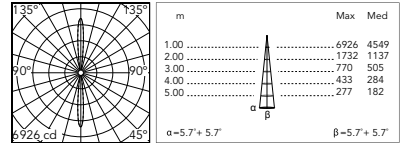

@3000K

Optic Medium

Power Led: 12W - 2x543 lm ≠ FIXT 2x319 lm - 2700K/CRI>80 - 220-240V / 12W - 2x570 lm ≠ FIXT 2x367 lm - 3000K/CRI>80 - 220-240V / 12W - 2x597 lm ≠ FIXT 2x402 lm - 4000/CRI>80 - 220-240V

2700K

Non Dimmable

○ F023H26A001	479,00 €
● F023H26A006	479,00 €
● F023H26A012	479,00 €
● F023H26A018	479,00 €
● F023H26A030	479,00 €
● F023H26A033	479,00 €
1-10V	
○ F023H26B001	578,00 €
● F023H26B006	578,00 €
● F023H26B012	578,00 €
● F023H26B018	578,00 €
● F023H26B030	578,00 €
● F023H26B033	578,00 €
Dali	
○ F023H26D001	578,00 €
● F023H26D006	578,00 €
● F023H26D012	578,00 €
● F023H26D018	578,00 €
● F023H26D030	578,00 €
● F023H26D033	578,00 €

3000K

Non Dimmable

○ F023H36A001	479,00 €
● F023H36A006	479,00 €
● F023H36A012	479,00 €
● F023H36A018	479,00 €
● F023H36A030	479,00 €
● F023H36A033	479,00 €
1-10V	
○ F023H36B001	578,00 €
● F023H36B006	578,00 €
● F023H36B012	578,00 €
● F023H36B018	578,00 €
● F023H36B030	578,00 €
● F023H36B033	578,00 €
Dali	
○ F023H36D001	578,00 €
● F023H36D006	578,00 €
● F023H36D012	578,00 €
● F023H36D018	578,00 €
● F023H36D030	578,00 €
● F023H36D033	578,00 €

4000K

Non Dimmable

○ F023H46A001	479,00 €
● F023H46A006	479,00 €
● F023H46A012	479,00 €
● F023H46A018	479,00 €
● F023H46A030	479,00 €
● F023H46A033	479,00 €
1-10V	
○ F023H46B001	578,00 €
● F023H46B006	578,00 €
● F023H46B012	578,00 €
● F023H46B018	578,00 €
● F023H46B030	578,00 €
● F023H46B033	578,00 €
Dali	
○ F023H46D001	578,00 €
● F023H46D006	578,00 €
● F023H46D012	578,00 €
● F023H46D018	578,00 €
● F023H46D030	578,00 €
● F023H46D033	578,00 €

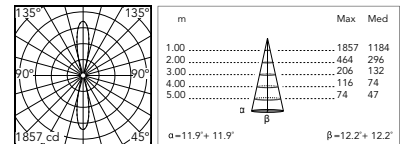

@3000K

* Spécifications techniques préliminaires. / Preliminary technical specs.

Optic Flood

Power Led: 12W - 2x543 lm ≠ FIXT 2x311 lm - 2700K/CRI>80 - 220-240V / 12W - 2x570 lm ≠ FIXT 2x325 lm - 3000K/CRI>80 - 220-240V /
12W - 2x597 lm ≠ FIXT 2x356 lm - 4000/CRI>80 - 220-240V

2700K

Non Dimmable

○ F023H27A001	479,00 €
● F023H27A006	479,00 €
● F023H27A012	479,00 €
● F023H27A018	479,00 €
● F023H27A030	479,00 €
● F023H27A033	479,00 €

1-10V

○ F023H27B001	578,00 €
● F023H27B006	578,00 €
● F023H27B012	578,00 €
● F023H27B018	578,00 €
● F023H27B030	578,00 €
● F023H27B033	578,00 €

Dali

○ F023H27D001	578,00 €
● F023H27D006	578,00 €
● F023H27D012	578,00 €
● F023H27D018	578,00 €
● F023H27D030	578,00 €
● F023H27D033	578,00 €

3000K

Non Dimmable

○ F023H37A001	479,00 €
● F023H37A006	479,00 €
● F023H37A012	479,00 €
● F023H37A018	479,00 €
● F023H37A030	479,00 €
● F023H37A033	479,00 €

1-10V

○ F023H37B001	578,00 €
● F023H37B006	578,00 €
● F023H37B012	578,00 €
● F023H37B018	578,00 €
● F023H37B030	578,00 €
● F023H37B033	578,00 €

Dali

○ F023H37D001	578,00 €
● F023H37D006	578,00 €
● F023H37D012	578,00 €
● F023H37D018	578,00 €
● F023H37D030	578,00 €
● F023H37D033	578,00 €

4000K

Non Dimmable

○ F023H47A001	479,00 €
● F023H47A006	479,00 €
● F023H47A012	479,00 €
● F023H47A018	479,00 €
● F023H47A030	479,00 €
● F023H47A033	479,00 €

1-10V

○ F023H47B001	578,00 €
● F023H47B006	578,00 €
● F023H47B012	578,00 €
● F023H47B018	578,00 €
● F023H47B030	578,00 €
● F023H47B033	578,00 €

Dali

○ F023H47D001	578,00 €
● F023H47D006	578,00 €
● F023H47D012	578,00 €
● F023H47D018	578,00 €
● F023H47D030	578,00 €
● F023H47D033	578,00 €

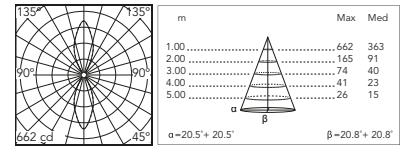

Pointbreak Wall 2 Down

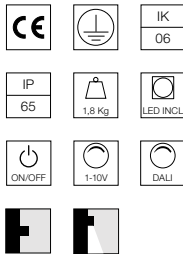
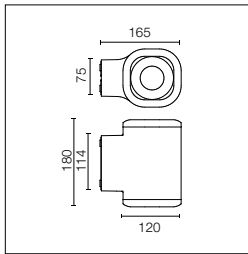

Source de lumière LED incluse.
Alimentation électrique intégrée
220-240V ON/OFF et réglable
1-10V ou DALI.
Équipé de doubles passe-fils
pour la connexion d'entrée et
de sortie.
Version à émission simple
vers le haut. Disponible sur
demande.

LED light source included.
Integrated 220-240V ON/OFF
and 1-10V/DALI dimmable
electrical power.
Equipped with double cable
gland for inlet and outlet
connection.
Upwards, single emission
version, available upon request.

2200K disponible sur demande.

2200K available on request.

Optic Spot

Power Led: 17W - 1890 lm ≠ FIXT 1108 lm - 2700K/CRI>80 - 220-240V / 17W - 1960 lm ≠ FIXT 1149 lm - 3000K/CRI>80 - 220-240V /
17W - 2030 lm ≠ FIXT 1190 lm - 4000/CRI>80 - 220-240V

2700K

Non Dimmable

○ F023J21A001	463,00 €
● F023J21A006	463,00 €
● F023J21A012	463,00 €
● F023J21A018	463,00 €
● F023J21A030	463,00 €
● F023J21A033	463,00 €
1-10V	
○ F023J21B001	562,00 €
● F023J21B006	562,00 €
● F023J21B012	562,00 €
● F023J21B018	562,00 €
● F023J21B030	562,00 €
● F023J21B033	562,00 €
Dali	
○ F023J21D001	562,00 €
● F023J21D006	562,00 €
● F023J21D012	562,00 €
● F023J21D018	562,00 €
● F023J21D030	562,00 €
● F023J21D033	562,00 €

3000K

Non Dimmable

○ F023J31A001	463,00 €
● F023J31A006	463,00 €
● F023J31A012	463,00 €
● F023J31A018	463,00 €
● F023J31A030	463,00 €
● F023J31A033	463,00 €
1-10V	
○ F023J31B001	562,00 €
● F023J31B006	562,00 €
● F023J31B012	562,00 €
● F023J31B018	562,00 €
● F023J31B030	562,00 €
● F023J31B033	562,00 €
Dali	
○ F023J31D001	562,00 €
● F023J31D006	562,00 €
● F023J31D012	562,00 €
● F023J31D018	562,00 €
● F023J31D030	562,00 €
● F023J31D033	562,00 €

4000K

Non Dimmable

○ F023J41A001	463,00 €
● F023J41A006	463,00 €
● F023J41A012	463,00 €
● F023J41A018	463,00 €
● F023J41A030	463,00 €
● F023J41A033	463,00 €
1-10V	
○ F023J41B001	562,00 €
● F023J41B006	562,00 €
● F023J41B012	562,00 €
● F023J41B018	562,00 €
● F023J41B030	562,00 €
● F023J41B033	562,00 €
Dali	
○ F023J41D001	562,00 €
● F023J41D006	562,00 €
● F023J41D012	562,00 €
● F023J41D018	562,00 €
● F023J41D030	562,00 €
● F023J41D033	562,00 €

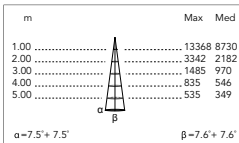
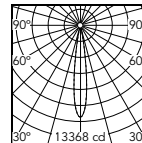

@3000K

Optic Medium

Power Led: 17W - 1890 lm ≠ FIXT 1215 lm - 2700K/CRI>80 - 220-240V / 17W - 1960 lm ≠ FIXT 1260 lm - 3000K/CRI>80 - 220-240V /
17W - 2030 lm ≠ FIXT 1305 lm - 4000/CRI>80 - 220-240V

2700K

Non Dimmable

○ F023J22A001	463,00 €
● F023J22A006	463,00 €
● F023J22A012	463,00 €
● F023J22A018	463,00 €
● F023J22A030	463,00 €
● F023J22A033	463,00 €
1-10V	
○ F023J22B001	562,00 €
● F023J22B006	562,00 €
● F023J22B012	562,00 €
● F023J22B018	562,00 €
● F023J22B030	562,00 €
● F023J22B033	562,00 €
Dali	
○ F023J22D001	562,00 €
● F023J22D006	562,00 €
● F023J22D012	562,00 €
● F023J22D018	562,00 €
● F023J22D030	562,00 €
● F023J22D033	562,00 €

3000K

Non Dimmable

○ F023J32A001	463,00 €
● F023J32A006	463,00 €
● F023J32A012	463,00 €
● F023J32A018	463,00 €
● F023J32A030	463,00 €
● F023J32A033	463,00 €
1-10V	
○ F023J32B001	562,00 €
● F023J32B006	562,00 €
● F023J32B012	562,00 €
● F023J32B018	562,00 €
● F023J32B030	562,00 €
● F023J32B033	562,00 €
Dali	
○ F023J32D001	562,00 €
● F023J32D006	562,00 €
● F023J32D012	562,00 €
● F023J32D018	562,00 €
● F023J32D030	562,00 €
● F023J32D033	562,00 €

4000K

Non Dimmable

○ F023J42A001	463,00 €
● F023J42A006	463,00 €
● F023J42A012	463,00 €
● F023J42A018	463,00 €
● F023J42A030	463,00 €
● F023J42A033	463,00 €
1-10V	
○ F023J42B001	562,00 €
● F023J42B006	562,00 €
● F023J42B012	562,00 €
● F023J42B018	562,00 €
● F023J42B030	562,00 €
● F023J42B033	562,00 €
Dali	
○ F023J42D001	562,00 €
● F023J42D006	562,00 €
● F023J42D012	562,00 €
● F023J42D018	562,00 €
● F023J42D030	562,00 €
● F023J42D033	562,00 €

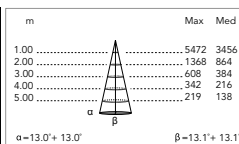
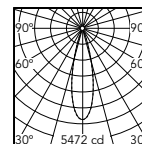

@3000K

* Spécifications techniques préliminaires. / Preliminary technical specs.

Optic Flood

Power Led: 17W - 1890 lm ≠ FIXT 1222 lm - 2700K/CRI>80 - 220-240V / 17W - 1960 lm ≠ FIXT 1267 lm - 3000K/CRI>80 - 220-240V / 17W - 2030 lm ≠ FIXT 1311 lm - 4000/CRI>80 - 220-240V

2700K

Non Dimmable

○ F023J23A001	463,00 €
● F023J23A006	463,00 €
● F023J23A012	463,00 €
● F023J23A018	463,00 €
● F023J23A030	463,00 €
● F023J23A033	463,00 €

1-10V

○ F023J23B001	562,00 €
● F023J23B006	562,00 €
● F023J23B012	562,00 €
● F023J23B018	562,00 €
● F023J23B030	562,00 €
● F023J23B033	562,00 €

Dali

○ F023J23D001	562,00 €
● F023J23D006	562,00 €
● F023J23D012	562,00 €
● F023J23D018	562,00 €
● F023J23D030	562,00 €
● F023J23D033	562,00 €

3000K

Non Dimmable

○ F023J33A001	463,00 €
● F023J33A006	463,00 €
● F023J33A012	463,00 €
● F023J33A018	463,00 €
● F023J33A030	463,00 €
● F023J33A033	463,00 €

1-10V

○ F023J33B001	562,00 €
● F023J33B006	562,00 €
● F023J33B012	562,00 €
● F023J33B018	562,00 €
● F023J33B030	562,00 €
● F023J33B033	562,00 €

Dali

○ F023J33D001	562,00 €
● F023J33D006	562,00 €
● F023J33D012	562,00 €
● F023J33D018	562,00 €
● F023J33D030	562,00 €
● F023J33D033	562,00 €

4000K

Non Dimmable

○ F023J43A001	463,00 €
● F023J43A006	463,00 €
● F023J43A012	463,00 €
● F023J43A018	463,00 €
● F023J43A030	463,00 €
● F023J43A033	463,00 €

1-10V

○ F023J43B001	562,00 €
● F023J43B006	562,00 €
● F023J43B012	562,00 €
● F023J43B018	562,00 €
● F023J43B030	562,00 €
● F023J43B033	562,00 €

Dali

○ F023J43D001	562,00 €
● F023J43D006	562,00 €
● F023J43D012	562,00 €
● F023J43D018	562,00 €
● F023J43D030	562,00 €
● F023J43D033	562,00 €

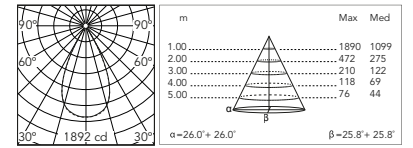

@3000K

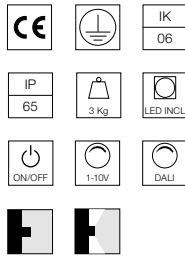
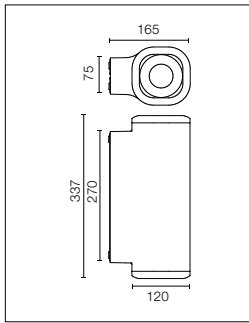

Source de lumière LED incluse.
Alimentation électrique intégrée
220-240V ON/OFF et réglable
1-10V ou DALI.
Équipé de doubles passe-fils
pour la connexion d'entrée et
de sortie.
Sur demande, version à
émission simple vers le haut ou
à émission simple vers le bas.

LED light source included.
Integrated 220-240V ON/OFF
and 1-10V/DALI dimmable
electrical power.
Equipped with double cable
gland for inlet and outlet
connection.
Upon request: Single upwards
emission or single downwards
emission.

2200K disponible sur demande.

2200K available on request.

Optic Spot

Power Led: 32W - 2x1890 lm ≠ FIXT 2x1108 lm - 2700K/CRI>80 - 220-240V / 32W - 2x1960 lm ≠ FIXT 2x1149 lm - 3000K/CRI>80 - 220-240V / 32W - 2x2030 lm ≠ FIXT 2x1190 lm - 4000/CRI>80 - 220-240V

2700K

Non Dimmable

- F023J25A001 589,00 €
- F023J25A006 589,00 €
- F023J25A012 589,00 €
- F023J25A018 589,00 €
- F023J25A030 589,00 €
- F023J25A033 589,00 €
- 1-10V
- F023J25B001 687,00 €
- F023J25B006 687,00 €
- F023J25B012 687,00 €
- F023J25B018 687,00 €
- F023J25B030 687,00 €
- F023J25B033 687,00 €

Dali

- F023J25D001 687,00 €
- F023J25D006 687,00 €
- F023J25D012 687,00 €
- F023J25D018 687,00 €
- F023J25D030 687,00 €
- F023J25D033 687,00 €

3000K

Non Dimmable

- F023J35A001 589,00 €
- F023J35A006 589,00 €
- F023J35A012 589,00 €
- F023J35A018 589,00 €
- F023J35A030 589,00 €
- F023J35A033 589,00 €
- 1-10V
- F023J35B001 687,00 €
- F023J35B006 687,00 €
- F023J35B012 687,00 €
- F023J35B018 687,00 €
- F023J35B030 687,00 €
- F023J35B033 687,00 €

Dali

- F023J35D001 687,00 €
- F023J35D006 687,00 €
- F023J35D012 687,00 €
- F023J35D018 687,00 €
- F023J35D030 687,00 €
- F023J35D033 687,00 €

4000K

Non Dimmable

- F023J45A001 589,00 €
- F023J45A006 589,00 €
- F023J45A012 589,00 €
- F023J45A018 589,00 €
- F023J45A030 589,00 €
- F023J45A033 589,00 €
- 1-10V
- F023J45B001 687,00 €
- F023J45B006 687,00 €
- F023J45B012 687,00 €
- F023J45B018 687,00 €
- F023J45B030 687,00 €
- F023J45B033 687,00 €

Dali

- F023J45D001 687,00 €
- F023J45D006 687,00 €
- F023J45D012 687,00 €
- F023J45D018 687,00 €
- F023J45D030 687,00 €
- F023J45D033 687,00 €

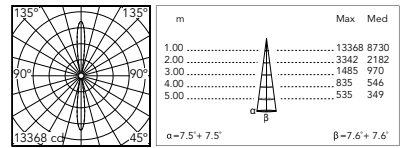

@3000K

Optic Medium

Power Led: 32W - 2x1890 lm ≠ FIXT 2x1215 lm - 2700K/CRI>80 - 220-240V / 32W - 2x1960 lm ≠ FIXT 2x1260 lm - 3000K/CRI>80 - 220-240V / 32W - 2x2030 lm ≠ FIXT 2x1305 lm - 4000/CRI>80 - 220-240V

2700K

Non Dimmable

- F023J26A001 589,00 €
- F023J26A006 589,00 €
- F023J26A012 589,00 €
- F023J26A018 589,00 €
- F023J26A030 589,00 €
- F023J26A033 589,00 €
- 1-10V
- F023J26B001 687,00 €
- F023J26B006 687,00 €
- F023J26B012 687,00 €
- F023J26B018 687,00 €
- F023J26B030 687,00 €
- F023J26B033 687,00 €

Dali

- F023J26D001 687,00 €
- F023J26D006 687,00 €
- F023J26D012 687,00 €
- F023J26D018 687,00 €
- F023J26D030 687,00 €
- F023J26D033 687,00 €

3000K

Non Dimmable

- F023J36A001 589,00 €
- F023J36A006 589,00 €
- F023J36A012 589,00 €
- F023J36A018 589,00 €
- F023J36A030 589,00 €
- F023J36A033 589,00 €
- 1-10V
- F023J36B001 687,00 €
- F023J36B006 687,00 €
- F023J36B012 687,00 €
- F023J36B018 687,00 €
- F023J36B030 687,00 €
- F023J36B033 687,00 €

Dali

- F023J36D001 687,00 €
- F023J36D006 687,00 €
- F023J36D012 687,00 €
- F023J36D018 687,00 €
- F023J36D030 687,00 €
- F023J36D033 687,00 €

4000K

Non Dimmable

- F023J46A001 589,00 €
- F023J46A006 589,00 €
- F023J46A012 589,00 €
- F023J46A018 589,00 €
- F023J46A030 589,00 €
- F023J46A033 589,00 €
- 1-10V
- F023J46B001 687,00 €
- F023J46B006 687,00 €
- F023J46B012 687,00 €
- F023J46B018 687,00 €
- F023J46B030 687,00 €
- F023J46B033 687,00 €

Dali

- F023J46D001 687,00 €
- F023J46D006 687,00 €
- F023J46D012 687,00 €
- F023J46D018 687,00 €
- F023J46D030 687,00 €
- F023J46D033 687,00 €

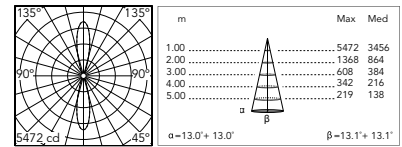

@3000K

* Spécifications techniques préliminaires. / Preliminary technical specs.

Optic Flood

Power Led: 32W - 2x1890 lm ≠ FIXT 2x1222 lm - 2700K/CRI>80 - 220-240V / 32W - 2x1960 lm ≠ FIXT 2x1267 lm - 3000K/CRI>80 - 220-240V / 32W - 2x2030 lm ≠ FIXT 2x1311 lm - 4000K/CRI>80 - 220-240V

2700K

Non Dimmable	
○ F023J27A001	589,00 €
● F023J27A006	589,00 €
● F023J27A012	589,00 €
● F023J27A018	589,00 €
● F023J27A030	589,00 €
● F023J27A033	589,00 €
1-10V	
○ F023J27B001	687,00 €
● F023J27B006	687,00 €
● F023J27B012	687,00 €
● F023J27B018	687,00 €
● F023J27B030	687,00 €
● F023J27B033	687,00 €
Dali	
○ F023J27D001	687,00 €
● F023J27D006	687,00 €
● F023J27D012	687,00 €
● F023J27D018	687,00 €
● F023J27D030	687,00 €
● F023J27D033	687,00 €

3000K

Non Dimmable	
○ F023J37A001	589,00 €
● F023J37A006	589,00 €
● F023J37A012	589,00 €
● F023J37A018	589,00 €
● F023J37A030	589,00 €
● F023J37A033	589,00 €
1-10V	
○ F023J37B001	687,00 €
● F023J37B006	687,00 €
● F023J37B012	687,00 €
● F023J37B018	687,00 €
● F023J37B030	687,00 €
● F023J37B033	687,00 €
Dali	
○ F023J37D001	687,00 €
● F023J37D006	687,00 €
● F023J37D012	687,00 €
● F023J37D018	687,00 €
● F023J37D030	687,00 €
● F023J37D033	687,00 €

4000K

Non Dimmable	
○ F023J47A001	589,00 €
● F023J47A006	589,00 €
● F023J47A012	589,00 €
● F023J47A018	589,00 €
● F023J47A030	589,00 €
● F023J47A033	589,00 €
1-10V	
○ F023J47B001	687,00 €
● F023J47B006	687,00 €
● F023J47B012	687,00 €
● F023J47B018	687,00 €
● F023J47B030	687,00 €
● F023J47B033	687,00 €
Dali	
○ F023J47D001	687,00 €
● F023J47D006	687,00 €
● F023J47D012	687,00 €
● F023J47D018	687,00 €
● F023J47D030	687,00 €
● F023J47D033	687,00 €

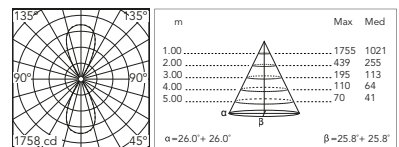

@3000K

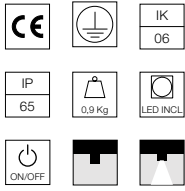
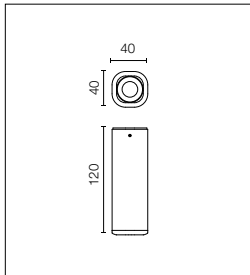

Source de lumière LED incluse.
Source d'alimentation intégrée
220-240V ON/OFF. Équipé d'un
passe-fil en caoutchouc IP65 et
de bornes de connexion rapide
à 2 pôles.

LED light source included.
Integrated 220-240V ON/OFF
electrical power. Equipped
with IP65 rubber grommet and
2-pole quick-connect terminals.

2200K disponible sur demande.

2200K available on request.

Optic Spot

Power LED: 2,1W - 139 lm ≠ *FIXT 101 lm - 2700K/CRI>80 - 220-240V / 2,1W - 149 lm ≠ *FIXT 104 lm - 3000K/CRI>80 - 220-240V / 2,1W - 154 lm ≠ *FIXT 108 lm - 4000/CRI>80 - 220-240V
*FIXT lm = Spot Optic

2700K		3000K		4000K	
Non Dimmable		Non Dimmable		Non Dimmable	
○ F023K21A001	264,00 €	○ F023K31A001	264,00 €	○ F023K41A001	264,00 €
● F023K21A006	264,00 €	● F023K31A006	264,00 €	● F023K41A006	264,00 €
● F023K21A012	264,00 €	● F023K31A012	264,00 €	● F023K41A012	264,00 €
● F023K21A018	264,00 €	● F023K31A018	264,00 €	● F023K41A018	264,00 €
● F023K21A030	264,00 €	● F023K31A030	264,00 €	● F023K41A030	264,00 €
● F023K21A033	264,00 €	● F023K31A033	264,00 €	● F023K41A033	264,00 €

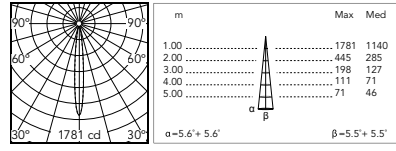

@3000K

Optic Medium

Power LED: 2,1W - 139 lm ≠ *FIXT 102 lm - 2700K/CRI>80 - 220-240V / 2,1W - 149 lm ≠ *FIXT 106 lm - 3000K/CRI>80 - 220-240V / 2,1W - 154 lm ≠ *FIXT 110 lm - 4000/CRI>80 - 220-240V
*FIXT lm = Spot Optic

2700K		3000K		4000K	
Non Dimmable		Non Dimmable		Non Dimmable	
○ F023K22A001	264,00 €	○ F023K32A001	264,00 €	○ F023K42A001	264,00 €
● F023K22A006	264,00 €	● F023K32A006	264,00 €	● F023K42A006	264,00 €
● F023K22A012	264,00 €	● F023K32A012	264,00 €	● F023K42A012	264,00 €
● F023K22A018	264,00 €	● F023K32A018	264,00 €	● F023K42A018	264,00 €
● F023K22A030	264,00 €	● F023K32A030	264,00 €	● F023K42A030	264,00 €
● F023K22A033	264,00 €	● F023K32A033	264,00 €	● F023K42A033	264,00 €

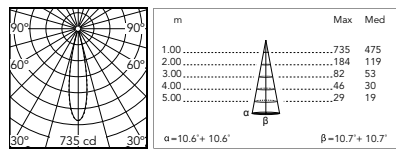

@3000K

Optic Flood

Power LED: 2,1W - 139 lm ≠ *FIXT 101 lm - 2700K/CRI>80 - 220-240V / 2,1W - 149 lm ≠ *FIXT 104 lm - 3000K/CRI>80 - 220-240V / 2,1W - 154 lm ≠ *FIXT 108 lm - 4000/CRI>80 - 220-240V
*FIXT lm = Spot Optic

2700K		3000K		4000K	
Non Dimmable		Non Dimmable		Non Dimmable	
○ F023K23A001	264,00 €	○ F023K33A001	264,00 €	○ F023K43A001	264,00 €
● F023K23A006	264,00 €	● F023K33A006	264,00 €	● F023K43A006	264,00 €
● F023K23A012	264,00 €	● F023K33A012	264,00 €	● F023K43A012	264,00 €
● F023K23A018	264,00 €	● F023K33A018	264,00 €	● F023K43A018	264,00 €
● F023K23A030	264,00 €	● F023K33A030	264,00 €	● F023K43A030	264,00 €
● F023K23A033	264,00 €	● F023K33A033	264,00 €	● F023K43A033	264,00 €

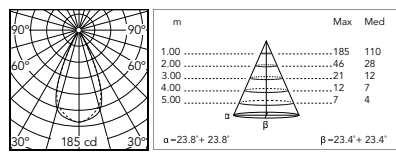

@3000K

* Spécifications techniques préliminaires. / Preliminary technical specs.

Pointbreak Ceiling 1

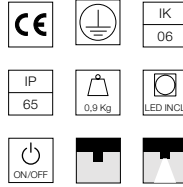
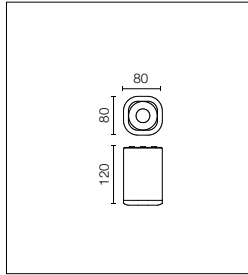

Source de lumière LED incluse.
Source d'alimentation intégrée
220-240V ON/OFF. Équipé
de doubles passe-fils pour la
connexion d'entrée et de sortie.

LED light source included.
Integrated 220-240V ON/OFF
electrical power. Equipped with
double cable gland for inlet and
outlet connection.

Optic Spot

Power LED: 5,5W - 543 lm ≠ FIXT 319 lm - 2700K/CRI>80 - 220-240V / 5,5W - 570 lm ≠ FIXT 335 lm - 3000K/CRI>80 - 220-240V /
5,5W - 597 lm ≠ FIXT 367 lm - 4000/CRI>80 - 220-240V

2700K

Non Dimmable

○ F023L21A001	343,00 €
● F023L21A006	343,00 €
● F023L21A012	343,00 €
● F023L21A018	343,00 €
● F023L21A030	343,00 €
● F023L21A033	343,00 €

3000K

Non Dimmable

○ F023L31A001	343,00 €
● F023L31A006	343,00 €
● F023L31A012	343,00 €
● F023L31A018	343,00 €
● F023L31A030	343,00 €
● F023L31A033	343,00 €

4000K

Non Dimmable

○ F023L41A001	343,00 €
● F023L41A006	343,00 €
● F023L41A012	343,00 €
● F023L41A018	343,00 €
● F023L41A030	343,00 €
● F023L41A033	343,00 €

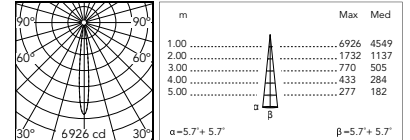

@3000K

Optic Medium

Power LED: 5,5W - 543 lm ≠ FIXT 350 lm - 2700K/CRI>80 - 220-240V / 5,5W - 570 lm ≠ FIXT 367 lm - 3000K/CRI>80 - 220-240V /
5,5W - 597 lm ≠ FIXT 402 lm - 4000/CRI>80 - 220-240V

2700K

Non Dimmable

○ F023L22A001	343,00 €
● F023L22A006	343,00 €
● F023L22A012	343,00 €
● F023L22A018	343,00 €
● F023L22A030	343,00 €
● F023L22A033	343,00 €

3000K

Non Dimmable

○ F023L32A001	343,00 €
● F023L32A006	343,00 €
● F023L32A012	343,00 €
● F023L32A018	343,00 €
● F023L32A030	343,00 €
● F023L32A033	343,00 €

4000K

Non Dimmable

○ F023L42A001	343,00 €
● F023L42A006	343,00 €
● F023L42A012	343,00 €
● F023L42A018	343,00 €
● F023L42A030	343,00 €
● F023L42A033	343,00 €

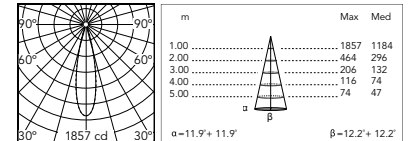

@3000K

Optic Flood

Power LED: 5,5W - 543 lm ≠ FIXT 311 lm - 2700K/CRI>80 - 220-240V / 5,5W - 570 lm ≠ FIXT 325 lm - 3000K/CRI>80 - 220-240V /
5,5W - 597 lm ≠ FIXT 356 lm - 4000/CRI>80 - 220-240V

2700K

Non Dimmable

○ F023L23A001	343,00 €
● F023L23A006	343,00 €
● F023L23A012	343,00 €
● F023L23A018	343,00 €
● F023L23A030	343,00 €
● F023L23A033	343,00 €

3000K

Non Dimmable

○ F023L33A001	343,00 €
● F023L33A006	343,00 €
● F023L33A012	343,00 €
● F023L33A018	343,00 €
● F023L33A030	343,00 €
● F023L33A033	343,00 €

4000K

Non Dimmable

○ F023L43A001	343,00 €
● F023L43A006	343,00 €
● F023L43A012	343,00 €
● F023L43A018	343,00 €
● F023L43A030	343,00 €
● F023L43A033	343,00 €

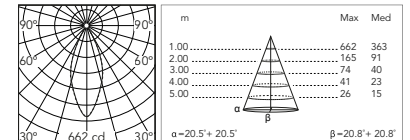

@3000K

* Spécifications techniques préliminaires. / Preliminary technical specs.

Pointbreak Ceiling 2

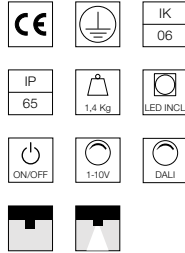
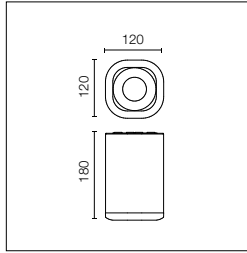

Source de lumière LED incluse.
Alimentation électrique intégrée
220-240V ON/OFF et réglable
1-10V ou DALI.
Équipé de doubles passe-fils
pour la connexion d'entrée et
de sortie.

LED light source included.
Integrated 220-240V ON/OFF
and 1-10V/DALI dimmable
electrical power.
Equipped with double cable
gland for inlet and outlet
connection.

2200K disponible sur demande.

2200K available on request.

Optic Spot

Power Led: 17W - 1890 lm ≠ FIXT 1108 lm - 2700K/CRI>80 - 220-240V / 17W - 1960 lm ≠ FIXT 1149 lm - 3000K/CRI>80 - 220-240V /
17W - 2030 lm ≠ FIXT 1190 lm - 4000K/CRI>80 - 220-240V

2700K

Non Dimmable

○ F023M21A001	448,00 €
● F023M21A006	448,00 €
● F023M21A012	448,00 €
● F023M21A018	448,00 €
● F023M21A030	448,00 €
● F023M21A033	448,00 €
1-10V	
○ F023M21B001	544,00 €
● F023M21B006	544,00 €
● F023M21B012	544,00 €
● F023M21B018	544,00 €
● F023M21B030	544,00 €
● F023M21B033	544,00 €
Dali	
○ F023M21D001	544,00 €
● F023M21D006	544,00 €
● F023M21D012	544,00 €
● F023M21D018	544,00 €
● F023M21D030	544,00 €
● F023M21D033	544,00 €

3000K

Non Dimmable

○ F023M31A001	448,00 €
● F023M31A006	448,00 €
● F023M31A012	448,00 €
● F023M31A018	448,00 €
● F023M31A030	448,00 €
● F023M31A033	448,00 €
1-10V	
○ F023M31B001	544,00 €
● F023M31B006	544,00 €
● F023M31B012	544,00 €
● F023M31B018	544,00 €
● F023M31B030	544,00 €
● F023M31B033	544,00 €
Dali	
○ F023M31D001	544,00 €
● F023M31D006	544,00 €
● F023M31D012	544,00 €
● F023M31D018	544,00 €
● F023M31D030	544,00 €
● F023M31D033	544,00 €

4000K

Non Dimmable

○ F023M41A001	448,00 €
● F023M41A006	448,00 €
● F023M41A012	448,00 €
● F023M41A018	448,00 €
● F023M41A030	448,00 €
● F023M41A033	448,00 €
1-10V	
○ F023M41B001	544,00 €
● F023M41B006	544,00 €
● F023M41B012	544,00 €
● F023M41B018	544,00 €
● F023M41B030	544,00 €
● F023M41B033	544,00 €
Dali	
○ F023M41D001	544,00 €
● F023M41D006	544,00 €
● F023M41D012	544,00 €
● F023M41D018	544,00 €
● F023M41D030	544,00 €
● F023M41D033	544,00 €

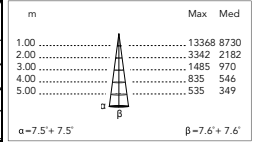
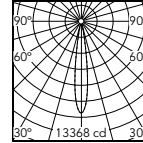

@3000K

Optic Medium

Power Led: 17W - 1890 lm ≠ FIXT 1215 lm - 2700K/CRI>80 - 220-240V / 17W - 1960 lm ≠ FIXT 1260 - 3000K/CRI>80 - 220-240V /
17W - 2030 lm ≠ FIXT 1305 lm - 4000K/CRI>80 - 220-240V

2700K

Non Dimmable

○ F023M22A001	448,00 €
● F023M22A006	448,00 €
● F023M22A012	448,00 €
● F023M22A018	448,00 €
● F023M22A030	448,00 €
● F023M22A033	448,00 €
1-10V	
○ F023M22B001	544,00 €
● F023M22B006	544,00 €
● F023M22B012	544,00 €
● F023M22B018	544,00 €
● F023M22B030	544,00 €
● F023M22B033	544,00 €
Dali	
○ F023M22D001	544,00 €
● F023M22D006	544,00 €
● F023M22D012	544,00 €
● F023M22D018	544,00 €
● F023M22D030	544,00 €
● F023M22D033	544,00 €

3000K

Non Dimmable

○ F023M32A001	448,00 €
● F023M32A006	448,00 €
● F023M32A012	448,00 €
● F023M32A018	448,00 €
● F023M32A030	448,00 €
● F023M32A033	448,00 €
1-10V	
○ F023M32B001	544,00 €
● F023M32B006	544,00 €
● F023M32B012	544,00 €
● F023M32B018	544,00 €
● F023M32B030	544,00 €
● F023M32B033	544,00 €
Dali	
○ F023M32D001	544,00 €
● F023M32D006	544,00 €
● F023M32D012	544,00 €
● F023M32D018	544,00 €
● F023M32D030	544,00 €
● F023M32D033	544,00 €

4000K

Non Dimmable

○ F023M42A001	448,00 €
● F023M42A006	448,00 €
● F023M42A012	448,00 €
● F023M42A018	448,00 €
● F023M42A030	448,00 €
● F023M42A033	448,00 €
1-10V	
○ F023M42B001	544,00 €
● F023M42B006	544,00 €
● F023M42B012	544,00 €
● F023M42B018	544,00 €
● F023M42B030	544,00 €
● F023M42B033	544,00 €
Dali	
○ F023M42D001	544,00 €
● F023M42D006	544,00 €
● F023M42D012	544,00 €
● F023M42D018	544,00 €
● F023M42D030	544,00 €
● F023M42D033	544,00 €

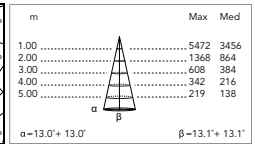
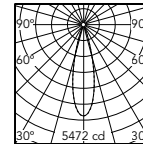

@3000K

* Spécifications techniques préliminaires. / Preliminary technical specs.

Optic Flood

Power Led: 17W - 1890 lm ≠ FIXT 1222 lm - 2700K/CRI>80 - 220-240V / 17W - 1960 lm ≠ FIXT 1267 lm - 3000K/CRI>80 - 220-240V /
17W - 2030 lm ≠ FIXT 1311 lm - 4000/CRI>80 - 220-240V

2700K

Non Dimmable

○ F023M23A001	448,00 €
● F023M23A006	448,00 €
● F023M23A012	448,00 €
● F023M23A018	448,00 €
● F023M23A030	448,00 €
● F023M23A033	448,00 €
1-10V	
○ F023M23B001	544,00 €
● F023M23B006	544,00 €
● F023M23B012	544,00 €
● F023M23B018	544,00 €
● F023M23B030	544,00 €
● F023M23B033	544,00 €
Dali	
○ F023M23D001	544,00 €
● F023M23D006	544,00 €
● F023M23D012	544,00 €
● F023M23D018	544,00 €
● F023M23D030	544,00 €
● F023M23D033	544,00 €

3000K

Non Dimmable

○ F023M33A001	448,00 €
● F023M33A006	448,00 €
● F023M33A012	448,00 €
● F023M33A018	448,00 €
● F023M33A030	448,00 €
● F023M33A033	448,00 €
1-10V	
○ F023M33B001	544,00 €
● F023M33B006	544,00 €
● F023M33B012	544,00 €
● F023M33B018	544,00 €
● F023M33B030	544,00 €
● F023M33B033	544,00 €
Dali	
○ F023M33D001	544,00 €
● F023M33D006	544,00 €
● F023M33D012	544,00 €
● F023M33D018	544,00 €
● F023M33D030	544,00 €
● F023M33D033	544,00 €

4000K

Non Dimmable

○ F023M43A001	448,00 €
● F023M43A006	448,00 €
● F023M43A012	448,00 €
● F023M43A018	448,00 €
● F023M43A030	448,00 €
● F023M43A033	448,00 €
1-10V	
○ F023M43B001	544,00 €
● F023M43B006	544,00 €
● F023M43B012	544,00 €
● F023M43B018	544,00 €
● F023M43B030	544,00 €
● F023M43B033	544,00 €
Dali	
○ F023M43D001	544,00 €
● F023M43D006	544,00 €
● F023M43D012	544,00 €
● F023M43D018	544,00 €
● F023M43D030	544,00 €
● F023M43D033	544,00 €

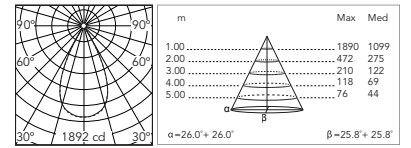

@3000K

In Vitro

Designed by Philippe Starck





In Vitro Unplugged



In Vitro Bollard





In Vitro Suspension

Famille / Family

In Vitro Unplugged



Led Edge Lighting

2,5W
115 lm - 2700K/CRI 80
124 lm - 3000K/CRI 80

In Vitro Bollard



Led Edge Lighting

11W
667 lm - 2700K/CRI 80
714 lm - 3000K/CRI 80

In Vitro Wall



Led Edge Lighting

11W
667 lm - 2700K/CRI 80
714 lm - 3000K/CRI 80

In Vitro Ceiling



Led Edge Lighting

13W
799 lm - 2700K/CRI 80
855 lm - 3000K/CRI 80

In Vitro Suspension



Led Edge Lighting

13W
799 lm - 2700K/CRI 80
855 lm - 3000K/CRI 80

In Vitro Rod



Led Edge Lighting

13W
799 lm - 2700K/CRI 80
855 lm - 3000K/CRI 80

Finitions / Colours



01 White

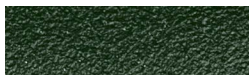

12 Forest Green



13 Pale Green



18 Deep Brown



25 Terracotta



30 Black



33 Anthracite

Description / Description

Luminaires d'extérieur pour installation au sol, au mur, au plafond, suspendue et luminaire portatif, avec lumière diffuse.

Diffuseur opale intégré dans la tête et verre de protection externe borosilicate transparent.

Les parties structurelles du luminaire sont en aluminium moulé sous pression, extrudé et traité par procédé de conversion chimique afin de garantir une résistance efficace aux agents atmosphériques. Le corps est enduit de poudre et plusieurs finitions sont disponibles.

Source de lumière LED intégrée avec technologie optique Edge Lighting qui garantit une uniformité parfaite de la lumière. Driver intégré dans le corps du luminaire, disponible pour le contrôle ON/OFF et la régulation.

La version Bollard est fournie avec un connecteur étanche pour la connexion au réseau. Le luminaire peut être installé sur tout type de sol à l'aide de chevilles que l'installateur choisira en fonction du type de surface. Le coffrage pour l'installation sur sol à bétonner est disponible comme accessoire et doit se commander séparément.

La version Unplugged est équipée d'une anse pratique en silicone coloré, et se recharge facilement grâce à un câble Micro USB-C de 120 mètres de long. Le driver réglable se trouve dans le corps du luminaire et dispose du système touch-dimm intégré, auquel on accède par un senseur optique situé sur la tête. Il est possible de régler l'intensité lumineuse du lampadaire sur 4 niveaux par une légère touche, ce qui assure une émission continue jusqu'à 6 heures.

Luminaires for floor, wall and suspended installation, and portable luminaire, with diffused light for outdoor use.

Opalescent diffuser integrated in the head and external transparent borosilicate safety glass.

The structural parts of the luminaire are made of extruded die-cast aluminum, treated with a chemical conversion procedure to ensure effective resistance to atmospheric conditions. The body is powder coated and comes in various finishes.

Integrated LED light source with Edge Lighting optical technology to ensure perfect light uniformity. Driver integrated in the luminaire body available for ON/OFF and dimmable control.

Bollard version comes with a watertight plug for power supply connection. The luminaire may be installed on any type of flooring using anchors, to be selected by the installer depending on the type of surface. Accessory box for installation on flooring to be concreted sold separately.

Unplugged version is equipped with a practical, colored silicone handle and is easily recharged with a 120cm long Micro USB-C cable. Dimmable driver in the body of the luminaire with an integrated touch-dim system, accessible through an optical switch sensor located on the head. With a simple touch, light intensity can be adjusted through a 4-step dimming function, ensuring a continuous emission for up to 6 hours.

In Vitro Unplugged

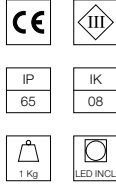
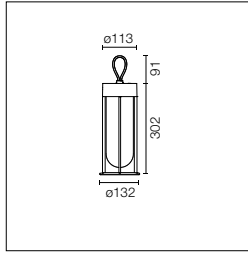

Version portable équipée d'une anse pour le transport. Driver réglable 5/100÷240V/50-60Hz intégré dans le corps du luminaire, avec senseur optique tactile sur la tête et réglage de l'intensité lumineuse en 4 touches: 100%-50%-3%-OFF. Rechargeable grâce à un câble Micro USB-C de 120 cm de long qui garantit une émission continue jusqu'à 6 heures. Chargeur avec prises interchangeables EUR, UK, USA.

Portable version equipped with a carrying handle. Adjustable driver 5/100÷240V/50-60Hz integrated in the body of the luminaire with optical switch sensor on the head and with a 4-step dimming function: 100%-50%-3%-OFF. Rechargeable with a 120cm long Micro USB-C cable ensuring continuous emission for up to 6 hours. Charger with interchangeable EUR, UK and USA plugs.

Led Edge Lighting: 2,5W - 182 lm ≠ FIXT 115 lm - 2700K/CRI 90 - 100-240V/V5 / 2,5W - 195 lm ≠ FIXT 124 lm - 3000K/CRI 90 - 100-240V/V5

2700K

Touch Dimm

○ F018E21K001	812,00 €
● F018E21K012	812,00 €
● F018E21K013	812,00 €
● F018E21K018	812,00 €
● F018E21K025	812,00 €
● F018E21K030	812,00 €
● F018E21K033	812,00 €

3000K

Touch Dimm

○ F018E31K001	812,00 €
● F018E31K012	812,00 €
● F018E31K013	812,00 €
● F018E31K018	812,00 €
● F018E31K025	812,00 €
● F018E31K030	812,00 €
● F018E31K033	812,00 €

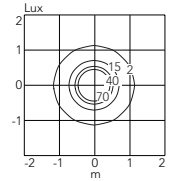
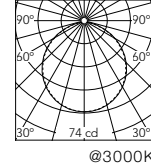

In Vitro Bollard 1

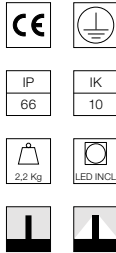
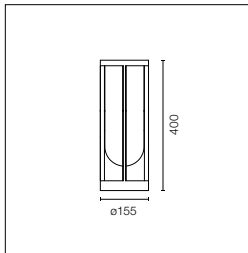

Alimentation électrique ON/OFF ou variable 220-240V intégrée. L'appareil est fourni avec un connecteur étanche pour le raccordement électrique. L'appareil peut être installé sur tous les types de sol à l'aide de chevilles. Boîtier pour installation en surface avec socle en béton à commander séparément.

Integrated 220-240V ON/OFF or dimmable electrical power. The unit comes with a watertight plug for connection to the electrical network. The device may be installed on any flooring with anchors. Box for installation on flooring laid over concrete sold separately.

Led Edge Lighting: 11W - 1150 lm ≠ FIXT 667 lm - 2700K/CRI 80 - 220-240V / 11W - 1230 lm ≠ FIXT 714 lm - 3000K/CRI 80 - 220-240V

2700K

Non Dimmable

○ F018A21A001	1.222,00 €
● F018A21A012	1.222,00 €
● F018A21A013	1.345,00 €
● F018A21A018	1.222,00 €
● F018A21A025	1.345,00 €
● F018A21A030	1.222,00 €
● F018A21A033	1.222,00 €
1-10V	
○ F018A21B001	1.339,00 €
● F018A21B012	1.339,00 €
● F018A21B013	1.472,00 €
● F018A21B018	1.339,00 €
● F018A21B025	1.472,00 €
● F018A21B030	1.339,00 €
● F018A21B033	1.339,00 €
Dali	
○ F018A21D001	1.339,00 €
● F018A21D012	1.339,00 €
● F018A21D013	1.472,00 €
● F018A21D018	1.339,00 €
● F018A21D025	1.472,00 €
● F018A21D030	1.339,00 €
● F018A21D033	1.339,00 €

3000K

Non Dimmable

○ F018A31A001	1.222,00 €
● F018A31A012	1.222,00 €
● F018A31A013	1.345,00 €
● F018A31A018	1.222,00 €
● F018A31A025	1.345,00 €
● F018A31A030	1.222,00 €
● F018A31A033	1.222,00 €
1-10V	
○ F018A31B001	1.339,00 €
● F018A31B012	1.339,00 €
● F018A31B013	1.472,00 €
● F018A31B018	1.339,00 €
● F018A31B025	1.472,00 €
● F018A31B030	1.339,00 €
● F018A31B033	1.339,00 €
Dali	
○ F018A31D001	1.339,00 €
● F018A31D012	1.339,00 €
● F018A31D013	1.472,00 €
● F018A31D018	1.339,00 €
● F018A31D025	1.472,00 €
● F018A31D030	1.339,00 €
● F018A31D033	1.339,00 €

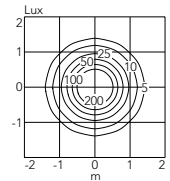
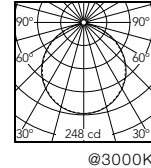

In Vitro Bollard 2

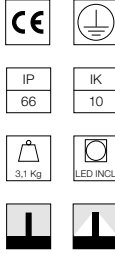
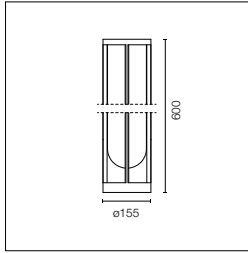

Alimentation électrique ON/OFF ou variable 220-240V intégrée. L'appareil est fourni avec un connecteur étanche pour le raccordement électrique. L'appareil peut être installé sur tous les types de sol à l'aide de chevilles. Boîtier pour installation en surface avec socle en béton à commander séparément.

Integrated 220–240V ON/OFF or dimmable electrical power. The unit comes with a watertight plug for connection to the electrical network. The device may be installed on any flooring with anchors. Box for installation on flooring laid over concrete sold separately.

Led Edge Lighting: 11W - 1150 lm ≠ FIXT 667 lm - 2700K/CRI 80 - 220-240V / 11W - 1230 lm ≠ FIXT 714 lm - 3000K/CRI 80 - 220-240V

2700K

Non Dimmable

○ F018A22A001	1.339,00 €
● F018A22A012	1.339,00 €
● F018A22A013	1.472,00 €
● F018A22A018	1.339,00 €
● F018A22A025	1.472,00 €
● F018A22A030	1.339,00 €
● F018A22A033	1.339,00 €

1-10V

○ F018A22B001	1.455,00 €
● F018A22B012	1.455,00 €
● F018A22B013	1.600,00 €
● F018A22B018	1.455,00 €
● F018A22B025	1.600,00 €
● F018A22B030	1.455,00 €
● F018A22B033	1.455,00 €

Dali

○ F018A22D001	1.455,00 €
● F018A22D012	1.455,00 €
● F018A22D013	1.600,00 €
● F018A22D018	1.455,00 €
● F018A22D025	1.600,00 €
● F018A22D030	1.455,00 €
● F018A22D033	1.455,00 €

3000K

Non Dimmable

○ F018A32A001	1.339,00 €
● F018A32A012	1.339,00 €
● F018A32A013	1.472,00 €
● F018A32A018	1.339,00 €
● F018A32A025	1.472,00 €
● F018A32A030	1.339,00 €
● F018A32A033	1.339,00 €

1-10V

○ F018A32B001	1.455,00 €
● F018A32B012	1.455,00 €
● F018A32B013	1.600,00 €
● F018A32B018	1.455,00 €
● F018A32B025	1.600,00 €
● F018A32B030	1.455,00 €
● F018A32B033	1.455,00 €

Dali

○ F018A32D001	1.455,00 €
● F018A32D012	1.455,00 €
● F018A32D013	1.600,00 €
● F018A32D018	1.455,00 €
● F018A32D025	1.600,00 €
● F018A32D030	1.455,00 €
● F018A32D033	1.455,00 €

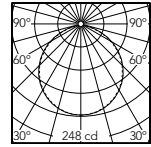

@3000K

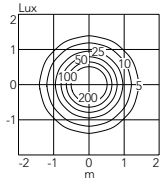

In Vitro Bollard 3

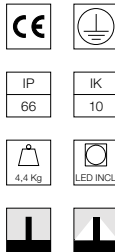
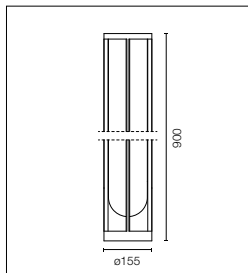

Alimentation électrique ON/OFF ou variable 220-240V intégrée. L'appareil est fourni avec un connecteur étanche pour le raccordement électrique. L'appareil peut être installé sur tous les types de sol à l'aide de chevilles. Boîtier pour installation en surface avec socle en béton à commander séparément.

Integrated 220–240V ON/OFF or dimmable electrical power. The unit comes with a watertight plug for connection to the electrical network. The device may be installed on any flooring with anchors. Box for installation on flooring laid over concrete sold separately.

Led Edge Lighting: 11W - 1150 lm ≠ FIXT 667 lm - 2700K/CRI 80 - 220-240V / 11W - 1230 lm ≠ FIXT 714 lm - 3000K/CRI 80 - 220-240V

2700K

Non Dimmable

○ F018A23A001	1.455,00 €
● F018A23A012	1.455,00 €
● F018A23A013	1.600,00 €
● F018A23A018	1.455,00 €
● F018A23A025	1.600,00 €
● F018A23A030	1.455,00 €
● F018A23A033	1.455,00 €

1-10V

○ F018A23B001	1.571,00 €
● F018A23B012	1.571,00 €
● F018A23B013	1.729,00 €
● F018A23B018	1.571,00 €
● F018A23B025	1.729,00 €
● F018A23B030	1.571,00 €
● F018A23B033	1.571,00 €

Dali

○ F018A23D001	1.571,00 €
● F018A23D012	1.571,00 €
● F018A23D013	1.729,00 €
● F018A23D018	1.571,00 €
● F018A23D025	1.729,00 €
● F018A23D030	1.571,00 €
● F018A23D033	1.571,00 €

3000K

Non Dimmable

○ F018A33A001	1.455,00 €
● F018A33A012	1.455,00 €
● F018A33A013	1.600,00 €
● F018A33A018	1.455,00 €
● F018A33A025	1.600,00 €
● F018A33A030	1.455,00 €
● F018A33A033	1.455,00 €

1-10V

○ F018A33B001	1.571,00 €
● F018A33B012	1.571,00 €
● F018A33B013	1.729,00 €
● F018A33B018	1.571,00 €
● F018A33B025	1.729,00 €
● F018A33B030	1.571,00 €
● F018A33B033	1.571,00 €

Dali

○ F018A33D001	1.571,00 €
● F018A33D012	1.571,00 €
● F018A33D013	1.729,00 €
● F018A33D018	1.571,00 €
● F018A33D025	1.729,00 €
● F018A33D030	1.571,00 €
● F018A33D033	1.571,00 €

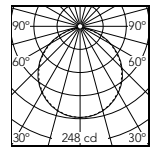

@3000K

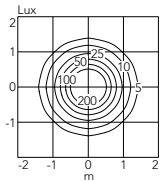

In Vitro Wall

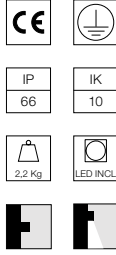
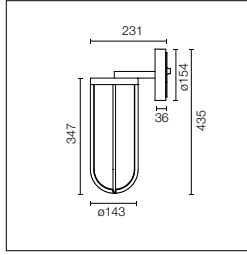

Fixation murale. Source lumineuse comprise. Alimentation électrique ON/OFF ou variable 220-240V intégrée.

Wall mount. Light source included. Integrated 220–240V ON/OFF or dimmable electrical power.

Led Edge Lighting: 11W - 1150 lm ≠ FIXT 667 lm - 2700K/CRI 80 - 220-240V / 11W - 1230 lm ≠ FIXT 714 lm - 3000K/CRI 80 - 220-240V

2700K

Non Dimmable

○ F018B22A001	1.222,00 €
● F018B22A012	1.222,00 €
● F018B22A013	1.345,00 €
● F018B22A018	1.222,00 €
● F018B22A025	1.345,00 €
● F018B22A030	1.222,00 €
● F018B22A033	1.222,00 €

1-10V

○ F018B22B001	1.339,00 €
● F018B22B012	1.339,00 €
● F018B22B013	1.472,00 €
● F018B22B018	1.339,00 €
● F018B22B025	1.472,00 €
● F018B22B030	1.339,00 €
● F018B22B033	1.339,00 €

Dali

○ F018B22D001	1.339,00 €
● F018B22D012	1.339,00 €
● F018B22D013	1.472,00 €
● F018B22D018	1.339,00 €
● F018B22D025	1.472,00 €
● F018B22D030	1.339,00 €
● F018B22D033	1.339,00 €

3000K

Non Dimmable

○ F018B32A001	1.222,00 €
● F018B32A012	1.222,00 €
● F018B32A013	1.345,00 €
● F018B32A018	1.222,00 €
● F018B32A025	1.345,00 €
● F018B32A030	1.222,00 €
● F018B32A033	1.222,00 €

1-10V

○ F018B32B001	1.339,00 €
● F018B32B012	1.339,00 €
● F018B32B013	1.472,00 €
● F018B32B018	1.339,00 €
● F018B32B025	1.472,00 €
● F018B32B030	1.339,00 €
● F018B32B033	1.339,00 €

Dali

○ F018B32D001	1.339,00 €
● F018B32D012	1.339,00 €
● F018B32D013	1.472,00 €
● F018B32D018	1.339,00 €
● F018B32D025	1.472,00 €
● F018B32D030	1.339,00 €
● F018B32D033	1.339,00 €

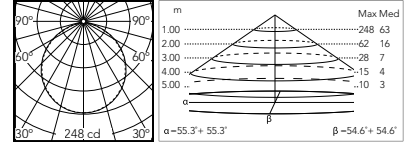

@3000K

In Vitro Ceiling

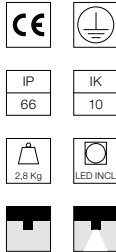
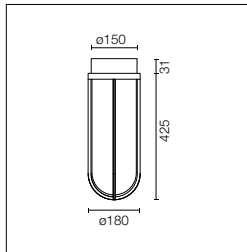

Source lumineuse comprise. Fixation plafond. Alimentation électrique ON/OFF ou variable 220-240V comprise.

Light source included. Ceiling mount. Integrated 220–240V ON/OFF or dimmable electrical power.

Led Edge Lighting: 13W - 1378 lm ≠ FIXT 799 lm - 2700K/CRI 80 - 220-240V / 13W - 1474 lm ≠ FIXT 855 lm - 3000K/CRI 80 - 220-240V

2700K

Non Dimmable

○ F018C25A001	1.339,00 €
● F018C25A012	1.339,00 €
● F018C25A013	1.472,00 €
● F018C25A018	1.339,00 €
● F018C25A025	1.472,00 €
● F018C25A030	1.339,00 €
● F018C25A033	1.339,00 €

1-10V

○ F018C25B001	1.455,00 €
● F018C25B012	1.455,00 €
● F018C25B013	1.600,00 €
● F018C25B018	1.455,00 €
● F018C25B025	1.600,00 €
● F018C25B030	1.455,00 €
● F018C25B033	1.455,00 €

Dali

○ F018C25D001	1.455,00 €
● F018C25D012	1.455,00 €
● F018C25D013	1.600,00 €
● F018C25D018	1.455,00 €
● F018C25D025	1.600,00 €
● F018C25D030	1.455,00 €
● F018C25D033	1.455,00 €

3000K

Non Dimmable

○ F018C35A001	1.339,00 €
● F018C35A012	1.339,00 €
● F018C35A013	1.472,00 €
● F018C35A018	1.339,00 €
● F018C35A025	1.472,00 €
● F018C35A030	1.339,00 €
● F018C35A033	1.339,00 €

1-10V

○ F018C35B001	1.455,00 €
● F018C35B012	1.455,00 €
● F018C35B013	1.600,00 €
● F018C35B018	1.455,00 €
● F018C35B025	1.600,00 €
● F018C35B030	1.455,00 €
● F018C35B033	1.455,00 €

Dali

○ F018C35D001	1.455,00 €
● F018C35D012	1.455,00 €
● F018C35D013	1.600,00 €
● F018C35D018	1.455,00 €
● F018C35D025	1.600,00 €
● F018C35D030	1.455,00 €
● F018C35D033	1.455,00 €

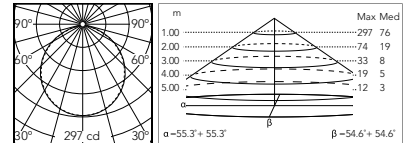

@3000K

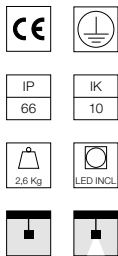
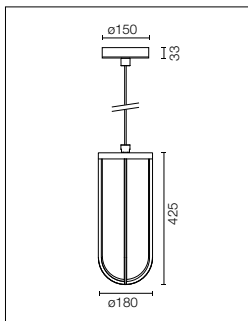

Suspension. Source lumineuse comprise. Alimentation électrique ON/OFF ou variable 220-240V intégrée à l'intérieur de la fixation au plafond. Longueur du câble de suspension 1000 mm.

Hanging version. Light source included. 220-240V ON/OFF or dimmable electrical power integrated within the dedicated ceiling attachment. Hanging cable length 1000 mm.

Led Edge Lighting: 13W - 1378 lm ≠ FIXT 799 lm - 2700K/CRI 80 - 220-240V / 13W - 1474 lm ≠ FIXT 855 lm - 3000K/CRI 80 - 220-240V

2700K

Non Dimmable

- F018D25A001 1.339,00 €
- F018D25A012 1.339,00 €
- F018D25A013 1.472,00 €
- F018D25A018 1.339,00 €
- F018D25A025 1.472,00 €
- F018D25A030 1.339,00 €
- F018D25A033 1.339,00 €
- 1-10V
- F018D25B001 1.455,00 €
- F018D25B012 1.455,00 €
- F018D25B013 1.600,00 €
- F018D25B018 1.455,00 €
- F018D25B025 1.600,00 €
- F018D25B030 1.455,00 €
- F018D25B033 1.455,00 €
- Dali
- F018D25D001 1.455,00 €
- F018D25D012 1.455,00 €
- F018D25D013 1.600,00 €
- F018D25D018 1.455,00 €
- F018D25D025 1.600,00 €
- F018D25D030 1.455,00 €
- F018D25D033 1.455,00 €

3000K

Non Dimmable

- F018D35A001 1.339,00 €
- F018D35A012 1.339,00 €
- F018D35A013 1.472,00 €
- F018D35A018 1.339,00 €
- F018D35A025 1.472,00 €
- F018D35A030 1.339,00 €
- F018D35A033 1.339,00 €
- 1-10V
- F018D35B001 1.455,00 €
- F018D35B012 1.455,00 €
- F018D35B013 1.600,00 €
- F018D35B018 1.455,00 €
- F018D35B025 1.600,00 €
- F018D35B030 1.455,00 €
- F018D35B033 1.455,00 €
- Dali
- F018D35D001 1.455,00 €
- F018D35D012 1.455,00 €
- F018D35D013 1.600,00 €
- F018D35D018 1.455,00 €
- F018D35D025 1.600,00 €
- F018D35D030 1.455,00 €
- F018D35D033 1.455,00 €

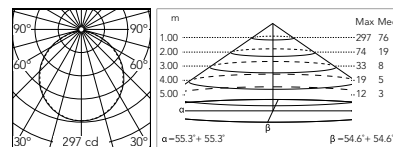

@3000K

In Vitro Rod 1

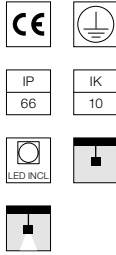
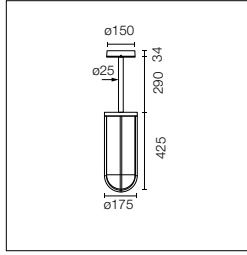

Installation sur tige. Source lumineuse comprise. Alimentation électrique ON/OFF ou dimmable 220-240 V intégrée à l'intérieur de la base pour plafond. Longueur de la tige: 290 mm.

Rod installation. Light source is included. Power supply ON/OFF or dimmable 220-240V is integrated within the ceiling base. Stem length: 290 mm.

Led Edge Lighting: 13W - 1378 lm ≠ FIXT 799 lm - 2700K/CRI 80 - 220-240V / 13W - 1474 lm ≠ FIXT 855 lm - 3000K/CRI 80 - 220-240V

2700K

Non Dimmable

○ F018F21A001	1.339,00 €
● F018F21A012	1.339,00 €
● F018F21A013	1.472,00 €
● F018F21A018	1.339,00 €
● F018F21A025	1.472,00 €
● F018F21A030	1.339,00 €
● F018F21A033	1.339,00 €

1-10V

○ F018F21B001	1.455,00 €
● F018F21B012	1.455,00 €
● F018F21B013	1.600,00 €
● F018F21B018	1.455,00 €
● F018F21B025	1.600,00 €
● F018F21B030	1.455,00 €
● F018F21B033	1.455,00 €

Dali

○ F018F21D001	1.455,00 €
● F018F21D012	1.455,00 €
● F018F21D013	1.600,00 €
● F018F21D018	1.455,00 €
● F018F21D025	1.600,00 €
● F018F21D030	1.455,00 €
● F018F21D033	1.455,00 €

3000K

Non Dimmable

○ F018F31A001	1.339,00 €
● F018F31A012	1.339,00 €
● F018F31A013	1.472,00 €
● F018F31A018	1.339,00 €
● F018F31A025	1.472,00 €
● F018F31A030	1.339,00 €
● F018F31A033	1.339,00 €

1-10V

○ F018F31B001	1.455,00 €
● F018F31B012	1.455,00 €
● F018F31B013	1.600,00 €
● F018F31B018	1.455,00 €
● F018F31B025	1.600,00 €
● F018F31B030	1.455,00 €
● F018F31B033	1.455,00 €

Dali

○ F018F31D001	1.455,00 €
● F018F31D012	1.455,00 €
● F018F31D013	1.600,00 €
● F018F31D018	1.455,00 €
● F018F31D025	1.600,00 €
● F018F31D030	1.455,00 €
● F018F31D033	1.455,00 €

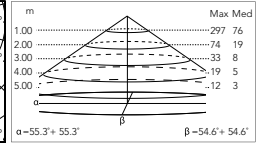
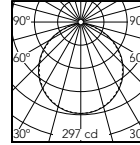

@3000K

In Vitro Rod 2

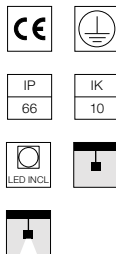
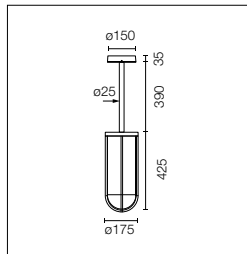

Installation sur tige. Source lumineuse comprise. Alimentation électrique ON/OFF ou dimmable 220-240 V intégrée à l'intérieur de la base pour plafond. Longueur de la tige: 390 mm.

Rod installation. Light source is included. Power supply ON/OFF or dimmable 220-240V is integrated within the ceiling base. Stem length: 390 mm.

Led Edge Lighting: 13W - 1378 lm ≠ FIXT 799 lm - 2700K/CRI 80 - 220-240V / 13W - 1474 lm ≠ FIXT 855 lm - 3000K/CRI 80 - 220-240V

2700K

Non Dimmable

○ F018F22A001	1.339,00 €
● F018F22A012	1.339,00 €
● F018F22A013	1.472,00 €
● F018F22A018	1.339,00 €
● F018F22A025	1.472,00 €
● F018F22A030	1.339,00 €
● F018F22A033	1.339,00 €

1-10V

○ F018F22B001	1.455,00 €
● F018F22B012	1.455,00 €
● F018F22B013	1.600,00 €
● F018F22B018	1.455,00 €
● F018F22B025	1.600,00 €
● F018F22B030	1.455,00 €
● F018F22B033	1.455,00 €

Dali

○ F018F22D001	1.455,00 €
● F018F22D012	1.455,00 €
● F018F22D013	1.600,00 €
● F018F22D018	1.455,00 €
● F018F22D025	1.600,00 €
● F018F22D030	1.455,00 €
● F018F22D033	1.455,00 €

3000K

Non Dimmable

○ F018F32A001	1.339,00 €
● F018F32A012	1.339,00 €
● F018F32A013	1.472,00 €
● F018F32A018	1.339,00 €
● F018F32A025	1.472,00 €
● F018F32A030	1.339,00 €
● F018F32A033	1.339,00 €

1-10V

○ F018F32B001	1.455,00 €
● F018F32B012	1.455,00 €
● F018F32B013	1.600,00 €
● F018F32B018	1.455,00 €
● F018F32B025	1.600,00 €
● F018F32B030	1.455,00 €
● F018F32B033	1.455,00 €

Dali

○ F018F32D001	1.455,00 €
● F018F32D012	1.455,00 €
● F018F32D013	1.600,00 €
● F018F32D018	1.455,00 €
● F018F32D025	1.600,00 €
● F018F32D030	1.455,00 €
● F018F32D033	1.455,00 €

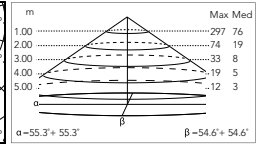
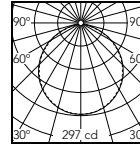

@3000K

In Vitro Bollard

Dispositif de protection contre les surtensions. 275Vac. Courant de décharge maximal 10KA (8/20us). Courant de fonctionnement maximal 5A. Adapté pour les connexions en séries. IP66.

Surge protection device. 275Vac. Maximum discharge current 10KA (8/20us). Maximum operating current 5A. Suitable for series connection. IP66.

F990E00A000 116,00 €

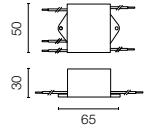

Système de jonction IP68 H2O Stop anti-condensation à 2 voies 4 pôles.

2 way terminal block 4 poles IP68 H2O Stop.

F990C00A000 33,00 €

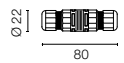

Boitier pour installation au sol.

Box for ground installation.

F018Z000000 59,00 €

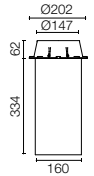

Mayday Outdoor

Designed by Konstantin Grcic







Famille / Family

Mayday Outdoor



Led Retrofit

Max. 10W
2700K/CRI 80
3000K/CRI 80

Finitions / Colours



Black



Leaf Green



Mustard Yellow

Description / Description

Luminaire polyvalent adapté à un usage extérieur. Son crochet/poignée pratique, qui sert également à enrouler le câble, est réalisé en polypropylène recyclé. Dans la version pour l'extérieur, il est disponible aussi bien dans la couleur noire classique que dans les teintes naturelles vert feuille et jaune moutarde. La poignée est dotée d'un interrupteur étanche ON/OFF très pratique. Le câble sortant de 6 mètres de long, adapté pour l'extérieur, est fixé à la poignée au moyen d'un passe-câble et équipé d'une prise Schuko IP44. Le diffuseur conique, de couleur opale, moulé par injection, est fabriqué en polypropylène durable obtenu à partir de déchets industriels.

La source lumineuse est protégée des agents atmosphériques par une capsule étanche et transparente en polyméthacrylate de méthyle, scellée par un joint en élastomère qui garantit un niveau de protection IP 65.

Mayday est facile à démonter afin que chaque pièce puisse être recyclée correctement ; aucune colle n'est utilisée dans le processus d'assemblage. L'emballage d'expédition est complété par un sac en pur drill de coton naturel.

Multipurpose luminaire suitable for outdoor use. Its practical hook/handle, which also serves to wind the cable, is made of recycled polypropylene. In the outdoor version, it is available both in the classic black color and in the natural shades of leaf green and mustard yellow. The handle has a convenient watertight ON/OFF switch. The 6 meters long outgoing cable, which is fixed to the handle by a cable guide, is suitable for outdoor use and has a Schuko IP44 plug. The conical diffuser, in opaline color and produced by injection printing, is made of sustainable polypropylene obtained from industrial waste.

The light source is protected from atmospheric agents by a watertight and transparent polymethylmethacrylate capsule, sealed by an elastomer seal that guarantees IP 65 protection.

Mayday is easy to disassemble so that each part can be properly recycled; no glue is used in the assembly process. The shipping packaging is completed with a pure natural cotton drill bag.

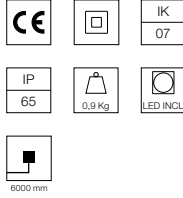
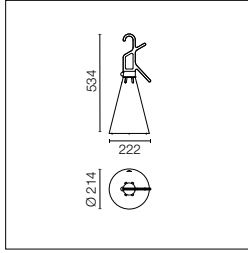

Douille pour ampoule E14, source lumineuse non incluse.
Alimentation électrique 220-240 V ON/OFF. Interrupteur IP65 sur la poignée du luminaire. Fourni avec un câble pour l'extérieur de 6 mètres de long et une prise Schuko IP44.

Socket for E14 bulb, light source not included.
220-240 V ON/OFF electric power supply. IP65 switch on the handle of the luminaire. It has a 6 meter long cable for outdoor use and an IP44 Schuko plug.

Led Retrofit: Max. 10W - E14 - 220-240V

2700K

- F038AAAA0ZZ 210,00 €
- F038AACA0ZZ 210,00 €
- F038AABA0ZZ 210,00 €

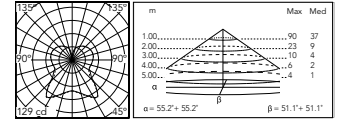

@3000K

Mayday Outdoor: Accessoires / Accessories

Lampe LED E14 8W 2700K 900 lm 230V T28.	LED lamp E14 8W 2700K 900 lm 230V T28.	RF32290	29,00 €	
---	--	---------	---------	--

Lampe LED E14 8W 3000K 900 lm 230V T28.	LED lamp E14 8W 3000K 900 lm 230V T28.	RF32291	29,00 €	
---	--	---------	---------	--

Mile

Designed by Antonio Citterio





Mile Wall



Mile Ceiling 1



Mile Bollard 1

Famille / Family

Mile Bollard 1 600

Mono / Double



Mile Bollard 2 600

Mono / Double

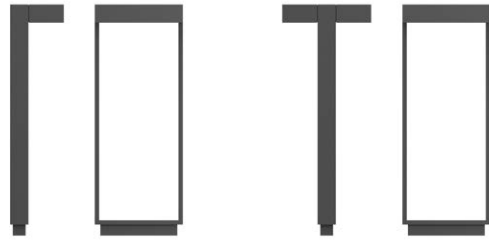

Mile Bollard 1 900

Mono / Double



Mile Bollard 2 900

Mono / Double



Mid - Power Led

4,9W

283 lm - 2700K/CRI 80

294 lm - 3000K/CRI 80

305 lm - 4000K/CRI 80

2200K available on request.

Mid - Power Led

9,8W

2x283 lm - 2700K/CRI 80

2x294 lm - 3000K/CRI 80

2x305 lm - 4000K/CRI 80

2200K available on request.

Mid - Power Led

7,8W

603 lm - 2700K/CRI 80

627 lm - 3000K/CRI 80

651 lm - 4000K/CRI 80

2200K available on request.

Mid - Power Led

15,6W

2x603 lm - 2700K/CRI 80

2x627 lm - 3000K/CRI 80

2x651 lm - 4000K/CRI 80

2200K available on request.

Finitions / Colours

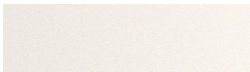

*00 Primer



01 White



06 Grey

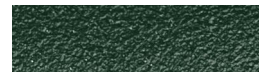

**12 Forest Green



18 Deep Brown



30 Black



33 Anthracite

* Uniquement pour les versions Wall, Path et Ceiling / Only for Wall, Path and Ceiling versions.

** Uniquement pour les versions Wall, Bollard et Path / Only for Wall, Bollard and Path versions.

Mile Path 1



Mid - Power Led

4,9W
up to 100 lm - 2700K/CRI 80
up to 104 lm - 3000K/CRI 80
up to 108 lm - 4000K/CRI 80
2200K available on request.

Mile Path 2



Mid - Power Led

7,6W
up to 172 lm - 2700K/CRI 80
up to 179 lm - 3000K/CRI 80
up to 186 lm - 4000K/CRI 80
2200K available on request.

Mile Wall 1

Up / Down / Up&Down



Mid - Power Led

4,9W
283 lm - 2700K/CRI 80
294 lm - 3000K/CRI 80
305 lm - 4000K/CRI 80
2200K available on request.

Mid - Power Led

8,1W
2x283 lm - 2700K/CRI 80
2x294 lm - 3000K/CRI 80
2x305 lm - 4000K/CRI 80
2200K available on request.

Washer

Up / Down / Up&Down

Mid - Power Led

4,9W
291 lm - 2700K/CRI 80
303 lm - 3000K/CRI 80
314 lm - 4000K/CRI 80
2200K available on request.

Mid - Power Led

8,1W
2x291 lm - 2700K/CRI 80
2x303 lm - 3000K/CRI 80
2x314 lm - 4000K/CRI 80
2200K available on request.

Mile Wall 2

Up / Down / Up&Down



Mid - Power Led

7,8W
603 lm - 2700K/CRI 80
627 lm - 3000K/CRI 80
651 lm - 4000K/CRI 80
2200K available on request.

Mid - Power Led

13,5W
2x603 lm - 2700K/CRI 80
2x627 lm - 3000K/CRI 80
2x651 lm - 4000K/CRI 80
2200K available on request.

Washer

Up / Down / Up&Down

Mid - Power Led

6,4W
453 lm - 2700K/CRI 80
471 lm - 3000K/CRI 80
489 lm - 4000K/CRI 80
2200K available on request.

Mid - Power Led

10,5W
2x453 lm - 2700K/CRI 80
2x471 lm - 3000K/CRI 80
2x489 lm - 4000K/CRI 80
2200K available on request.

Mile Ceiling 1



Mile Ceiling 2



Mile Recessed 1



Power Led

11W
736 lm - 2700K/CRI 80
759 lm - 3000K/CRI 80
791 lm - 4000K/CRI 80
2200K available on request.

Mile Recessed 2



Power Led

15W
1032 lm - 2700K/CRI 80
1344 lm - 3000K/CRI 80
1400 lm - 4000K/CRI 80
2200K available on request.

Mile Bollard

Collection de bornes lumineuses LED d'extérieur au design rigoureux et minimaliste à associer aux versions murales. Borne en version unidirectionnelle ou bidirectionnelle, disponible en deux hauteurs et en deux largeurs en fonction de la source lumineuse et de la puissance requise, caractérisée par un cadre rigoureux en aluminium extrudé sans vis apparentes, avec une base au sol surélevée pour une installation plus facile et plus rapide. Les vis de fixation de la tête sont en acier inoxydable AISI 316L.

Disponible en différentes finitions avec un revêtement à poudre double couche et traitement par conversion chimique pour la protéger de la corrosion.

Le diffuseur est en polycarbonate transparent stabilisé aux rayons UV.

L'écran réflecteur asymétrique fabriqué en aluminium pur, oxydé et poli, contient la source LED placée en arrière pour diminuer l'éblouissement direct. L'émission asymétrique de lumière vers le bas fait que le luminaire respecte les règles en vigueur concernant la pollution lumineuse.

Les versions Bollard peuvent être facilement installées sur tout type de sol à l'aide de chevilles ou en utilisant la plaque d'ancrage disponible comme accessoire à cet effet pour que la base du produit soit complètement intégrée au sol.

Mile Path

Collection de luminaires LED muraux d'extérieur au design rigoureux et minimaliste à associer aux versions murales et borne.

Disponible en deux dimensions et en différentes finitions avec un revêtement à poudre double couche.

La version Primer est peinte après l'installation avec les couleurs typiques à base d'eau (tempera, stucs, peintures à l'eau) pour garantir la meilleure intégration dans l'architecture.

Les vis de fixation sont en acier inoxydable AISI 316L. Le diffuseur est en polycarbonate transparent stabilisé aux rayons UV.

L'écran réflecteur asymétrique est fabriqué en aluminium peint en noir pour réduire l'éblouissement direct des reflets et contient la source LED placée en arrière. L'émission asymétrique de lumière vers le bas fait que le luminaire respecte les règles en vigueur concernant la pollution lumineuse.

Support de fixation murale inclus.

Mile Wall

Famille complète de luminaires LED muraux au design rigoureux et minimaliste caractérisés par un embellisseur en aluminium moulé sous pression à très faible teneur en cuivre offrant de bonnes caractéristiques mécaniques et une bonne résistance à la corrosion grâce au traitement par conversion chimique de la surface.

Disponible en deux dimensions et en différentes finitions avec un revêtement à poudre double couche.

La version Primer est peinte après l'installation avec les couleurs typiques à base d'eau (tempera, stucs, peintures à l'eau) pour garantir la meilleure intégration dans l'architecture.

Les vis de fixation sont en acier inoxydable AISI 316L. Le diffuseur parfaitement coplanaire au bandeau décoratif est en polycarbonate transparent stabilisé aux rayons UV.

L'écran réflecteur asymétrique en aluminium pur, oxydé et poli, contient la source LED placée en arrière pour diminuer l'éblouissement direct.

L'optique asymétrique est conçue pour offrir une large gamme de prestations lumineuses et une utilisation adaptable à différents contextes architectoniques. Deux versions sont disponibles : une version à émission simple avec lumière dirigée vers le haut ou vers le bas, et une version à émission double. Chaque version est déclinée en deux solutions

d'éclairage : éclairage lèche-mur ou éclairage asymétrique, par exemple pour les arcades ou les portes d'entrée. La version avec lumière vers le haut permet d'utiliser le plafond comme un diffuseur, offrant ainsi un confort maximum. La version à émission double est disponible avec des optiques identiques ou avec des optiques mixtes (asymétrique + washer).

Mile Ceiling

Collection de plafonniers LED d'extérieur au design rigoureux et minimaliste à associer aux versions murales, borne et path. Disponible en deux tailles et en différentes finitions avec un revêtement à poudre double couche.

La version Primer est peinte après l'installation avec les couleurs typiques à base d'eau (tempera, stucs, peintures à l'eau) pour garantir la meilleure intégration dans l'architecture.

L'unité optique est spécialement conçue pour garantir un confort visuel maximal et réduire l'éblouissement direct sans compromettre l'efficacité. La source lumineuse est composée de LED de puissance placées en arrière, les lentilles en polycarbonate transparent assurent un faisceau lumineux contrôlé et homogène, et les réflecteurs coniques en polycarbonate noir brillant assurent un blindage avec des angles de coupure extrêmes, le tout dans une taille réduite.

L'unité optique est disponible en quatre angles de faisceau différents, ce qui permet une large gamme d'utilisation et une grande flexibilité dans les contextes architecturaux les plus variés : que ce soit pour des faisceaux intenses ou des effets de lumière diffuse, le contrôle optique est toujours exceptionnel et la lumière parasite est totalement absente.

Les vis de fixation sont en acier inoxydable AISI 316L. Support de fixation pour plafond inclus.

Mile Recessed

Collection de plafonniers encastrables LED d'extérieur au design rigoureux et minimaliste à associer aux versions au plafond, murales, borne et path.

Disponible en deux tailles et en différentes finitions avec un revêtement à poudre double couche.

La version Primer est peinte après l'installation avec les couleurs typiques à base d'eau (tempera, stucs, peintures à l'eau) pour garantir la meilleure intégration dans l'architecture.

Comme pour les versions pour plafond, l'unité optique est spécialement conçue pour garantir un confort visuel maximal et réduire l'éblouissement direct sans compromettre l'efficacité. La source lumineuse est composée de LED de puissance placées en arrière, les lentilles en polycarbonate transparent assurent un faisceau lumineux contrôlé et homogène, et les réflecteurs coniques en polycarbonate noir brillant assurent un blindage avec des angles de coupure extrêmes, le tout dans une taille réduite.

L'unité optique est disponible en quatre angles de faisceau différents, ce qui permet une large gamme d'utilisation et une grande flexibilité dans les contextes architecturaux les plus variés : que ce soit pour des faisceaux intenses ou des effets de lumière diffuse, le contrôle optique est toujours exceptionnel et la lumière parasite est totalement absente.

Le luminaire peut être installé dans des faux-plafonds fournis avec des ressorts. Le cadre de bord, d'épaisseur minimale, permet une finition esthétique parfaite du luminaire dans le plafond.

Le coffrage en acier galvanisé à bétonner est disponible comme accessoire pour les plafonds en brique ou en béton armé.

Description

Mile Bollard

Collection of outdoor bollards with a rigorous, minimal design and LED light source that can be combined with wall versions.

Uni- or bi-directional bollard version, available in two heights and widths, based on light source and power requirements. The rigid frame is made of extruded aluminum with no visible screws, and the base rises above the ground for a quick, simple installation. The head anchoring hardware is made of AISI 316L stainless steel.

Available in various finishes with a double layer of powder coating and chemical conversion treatment to protect it against corrosion.

The diffuser is made of transparent, UV-stabilized polycarbonate.

The asymmetric reflecting screen is made of pure, oxidized and polished aluminum, with LED source in a rear position to reduce direct glare. The downward, asymmetric light emission ensures the luminaire's compliance with existing light pollution laws.

Bollard versions may be easily installed on any flooring on the ground with anchors, or with the dedicated anchoring plate accessory to completely integrate the base of the product with the pavement.

Mile Path

Collection of outdoor wall luminaires with a rigorous, minimal design and LED light source that can be combined with wall and bollard versions.

Available in two sizes and various finishes with a double layer of powder coating.

Primer version to be painted after installation with regular water-based colors (tempera, stucco, water-based paints) to ensure flawless integration with the building.

The anchoring hardware is made of AISI 316L stainless steel. Diffuser is made of transparent, UV-stabilized polycarbonate. The asymmetric, reflecting screen is made of aluminum painted in black to reduce direct glare from reflections. It holds the LED source in a rear position. The downward, asymmetric light emission ensures the luminaire's compliance with existing light pollution laws.

Wall mounting bracket included.

Mile Wall

Complete family of wall luminaires with a rigorous, minimal design with LED light source, a design characterized by a die-cast aluminum trim with very low copper content and good mechanical features combined with good resistance against corrosion thanks to the surface chemical conversion treatment.

Available in two sizes and various finishes with a double layer of powder coating.

Primer version to be painted after installation with regular water-based colors (tempera, stucco, water-based paints) to ensure flawless integration with the building.

The anchoring hardware is made of AISI 316L stainless steel. The diffuser is perfectly flush with the decorative band and is made of transparent, UV-stabilized polycarbonate.

The asymmetric, reflecting screen is made of pure, oxidized and polished aluminum, with LED source in a rear position to reduce direct glare.

Its asymmetrical optical unit is designed to ensure a wide range of lighting features and flexible use in different architectural settings. Single-emission version directing light upwards or downwards and dual-emission version available. Each version is available in two different lighting solutions: wall-washer lighting or asymmetric lighting. For instance, by

using the version with light directed upwards in porticos or entrance halls, the ceiling itself becomes a diffuser, offering absolute comfort. Dual emission version is available with both identical optical units and mixed, asymmetric + washer optical units.

Mile Ceiling

Outdoor ceiling-mounted lights collection, with a rigorous, minimal design and LED light source that can be combined with wall, bollard and path versions.

Available in two different sizes and various finishes with a double layer of powder coating.

Primer version to be painted after installation with regular water-based colors (tempera, stucco, water-based paints) to ensure flawless integration with the building.

The optical unit is specifically designed to ensure maximum visual comfort and direct glare reduction without compromising overall efficiency: the light source comprises rear power LEDs; its transparent polycarbonate lenses ensure a controlled and homogeneous beam of light; and the glossy black polycarbonate cone reflectors provide an extreme, sharp-angled screening, all in a small footprint.

The optical unit is available in four different beam angles, allowing a wide range of uses and flexibility in the most varied architectural settings: both in the case of intense beams and diffuse light effects, optical control is always exceptional and spurious light is totally absent.

The anchoring hardware is made of AISI 316L stainless steel. Ceiling mounting bracket included.

Mile Recessed

Collection of outdoor, ceiling-mounted, recessed lights with a rigorous, minimal design and LED light source that can be combined with ceiling, wall, bollard and path versions.

Available in two different sizes and various finishes with a double layer of powder coating.

Primer version to be painted after installation with regular water-based colors (tempera, stucco, water-based paints) to ensure flawless integration with the building.

As in ceiling versions, the optical unit is specifically designed to ensure maximum visual comfort and direct glare reduction without compromising overall efficiency: the light source comprises rear power LEDs; its transparent polycarbonate lenses ensure a controlled and homogeneous beam of light; and the glossy black polycarbonate cone reflectors provide an extreme, sharp-angled screening, all in a small footprint. The optical unit is available in four different beam angles, allowing a wide range of uses and flexibility in the most varied architectural settings: both in the case of intense beams and diffuse light effects, optical control is always exceptional and spurious light is totally absent.

The luminaire can be installed in a drop ceiling using the supplied springs. The minimal thickness of the stop frame allows a perfect, aesthetic finish of the luminaire in the ceiling.

The accessory box for installation in galvanized steel for concreting is available for brick or reinforced concrete ceilings.

Mile Bollard 1 600 Mono

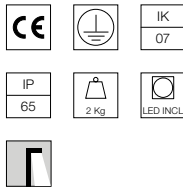
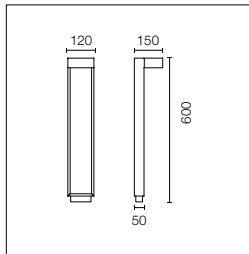

Source lumineuse LED incluse. Alimentation électrique 220-240V ON/OFF intégrée. Equipé d'un morceau de câble sortant en néoprène et d'un système avec joint anti-condensation IP68 H₂O à 2 voies. L'appareil peut être installé sur tous les sols à l'aide de chevilles. Plaque d'ancrage pour installation en surface avec socle en béton à commander séparément.

LED light source included. Integrated 220-240V ON/OFF electrical power. Equipped with a length of neoprene cable and an IP68 2-way anti-condensation H₂O stop seal system. The device may be installed on any flooring with anchors. Anchoring plate for installation on flooring laid over concrete sold separately.

2200K disponible sur demande.

2200K available on request.

Mid - Power Led: 4,9W - 427 lm ≠ FIXT 283 lm - 2700K/CRI 80 - 220-240V / 4,9W - 445 lm ≠ FIXT 294 lm - 3000K/CRI 80 - 220-240V / 4,9W - 462 lm ≠ FIXT 305 lm - 4000K/CRI 80 - 220-240V

2700K

○ F015G21A001	931,00 €
● F015G21A006	931,00 €
● F015G21A012	931,00 €
● F015G21A018	931,00 €
● F015G21A030	931,00 €
● F015G21A033	931,00 €

3000K

○ F015G31A001	931,00 €
● F015G31A006	931,00 €
● F015G31A012	931,00 €
● F015G31A018	931,00 €
● F015G31A030	931,00 €
● F015G31A033	931,00 €

4000K

○ F015G41A001	931,00 €
● F015G41A006	931,00 €
● F015G41A012	931,00 €
● F015G41A018	931,00 €
● F015G41A030	931,00 €
● F015G41A033	931,00 €

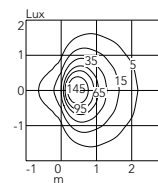
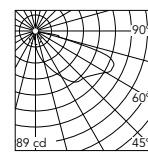

@3000K

Mile Bollard 1 600 Double

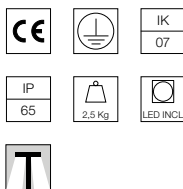
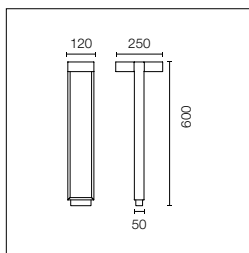

Source lumineuse LED incluse. Alimentation électrique 220-240V ON/OFF intégrée. Equipé d'un morceau de câble sortant en néoprène et d'un système avec joint anti-condensation IP68 H₂O à 2 voies. L'appareil peut être installé sur tous les sols à l'aide de chevilles. Plaque d'ancrage pour installation en surface avec socle en béton à commander séparément.

LED light source included. Integrated 220-240V ON/OFF electrical power. Equipped with a length of neoprene cable and an IP68 2-way anti-condensation H₂O stop seal system. The device may be installed on any flooring with anchors. Anchoring plate for installation on flooring laid over concrete sold separately.

2200K disponible sur demande.

2200K available on request.

Mid - Power Led: 9,8W - 2x427 lm ≠ FIXT 2x283 lm - 2700K/CRI 80 - 220-240V / 9,8W - 2x445 lm ≠ FIXT 2x294 lm - 3000K/CRI 80 - 220-240V / 9,8W - 2x462 lm ≠ FIXT 2x305 lm - 4000K/CRI 80 - 220-240V

2700K

○ F015G22A001	1.271,00 €
● F015G22A006	1.271,00 €
● F015G22A012	1.271,00 €
● F015G22A018	1.271,00 €
● F015G22A030	1.271,00 €
● F015G22A033	1.271,00 €

3000K

○ F015G32A001	1.271,00 €
● F015G32A006	1.271,00 €
● F015G32A012	1.271,00 €
● F015G32A018	1.271,00 €
● F015G32A030	1.271,00 €
● F015G32A033	1.271,00 €

4000K

○ F015G42A001	1.271,00 €
● F015G42A006	1.271,00 €
● F015G42A012	1.271,00 €
● F015G42A018	1.271,00 €
● F015G42A030	1.271,00 €
● F015G42A033	1.271,00 €

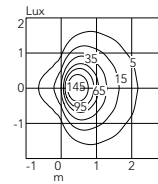
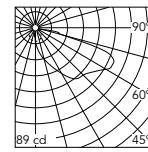

@3000K

Mile Bollard 1 900 Mono

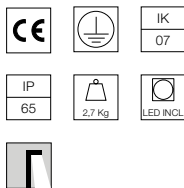
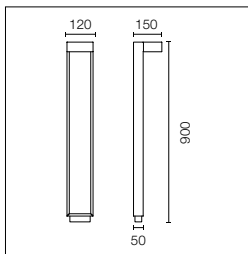

Source lumineuse LED incluse. Alimentation électrique 220-240V ON/OFF intégrée. Equipé d'un morceau de câble sortant en néoprène et d'un système avec joint anti-condensation IP68 H₂O à 2 voies. L'appareil peut être installé sur tous les sols à l'aide de chevilles. Plaque d'ancrage pour installation en surface avec socle en béton à commander séparément.

LED light source included. Integrated 220-240V ON/OFF electrical power. Equipped with a length of neoprene cable and an IP68 2-way anti-condensation H₂O stop seal system. The device may be installed on any flooring with anchors. Anchoring plate for installation on flooring laid over concrete sold separately.

2200K disponible sur demande.

2200K available on request.

Mid - Power Led: 4,9W - 427 lm ≠ FIXT 283 lm - 2700K/CRI 80 - 220-240V / 4,9W - 445 lm ≠ FIXT 294 lm - 3000K/CRI 80 - 220-240V / 4,9W - 462 lm ≠ FIXT 305 lm - 4000K/CRI 80 - 220-240V

2700K

○ F015H21A001	1.037,00 €
● F015H21A006	1.037,00 €
● F015H21A012	1.037,00 €
● F015H21A018	1.037,00 €
● F015H21A030	1.037,00 €
● F015H21A033	1.037,00 €

3000K

○ F015H31A001	1.037,00 €
● F015H31A006	1.037,00 €
● F015H31A012	1.037,00 €
● F015H31A018	1.037,00 €
● F015H31A030	1.037,00 €
● F015H31A033	1.037,00 €

4000K

○ F015H41A001	1.037,00 €
● F015H41A006	1.037,00 €
● F015H41A012	1.037,00 €
● F015H41A018	1.037,00 €
● F015H41A030	1.037,00 €
● F015H41A033	1.037,00 €

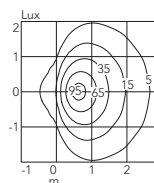
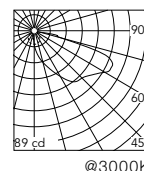

Mile Bollard 1 900 Double

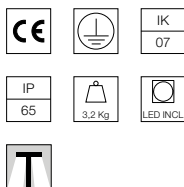
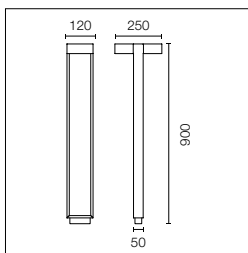

Source lumineuse LED incluse. Alimentation électrique 220-240V ON/OFF intégrée. Equipé d'un morceau de câble sortant en néoprène et d'un système avec joint anti-condensation IP68 H₂O à 2 voies. L'appareil peut être installé sur tous les sols à l'aide de chevilles. Plaque d'ancrage pour installation en surface avec socle en béton à commander séparément.

LED light source included. Integrated 220-240V ON/OFF electrical power. Equipped with a length of neoprene cable and an IP68 2-way anti-condensation H₂O stop seal system. The device may be installed on any flooring with anchors. Anchoring plate for installation on flooring laid over concrete sold separately.

2200K disponible sur demande.

2200K available on request.

Mid - Power Led: 9,8W - 2x427 lm ≠ FIXT 2x283 lm - 2700K/CRI 80 - 220-240V / 9,8W - 2x445 lm ≠ FIXT 2x294 lm - 3000K/CRI 80 - 220-240V / 9,8W - 2x462 lm ≠ FIXT 2x305 lm - 4000K/CRI 80 - 220-240V

2700K

○ F015H22A001	1.388,00 €
● F015H22A006	1.388,00 €
● F015H22A012	1.388,00 €
● F015H22A018	1.388,00 €
● F015H22A030	1.388,00 €
● F015H22A033	1.388,00 €

3000K

○ F015H32A001	1.388,00 €
● F015H32A006	1.388,00 €
● F015H32A012	1.388,00 €
● F015H32A018	1.388,00 €
● F015H32A030	1.388,00 €
● F015H32A033	1.388,00 €

4000K

○ F015H42A001	1.388,00 €
● F015H42A006	1.388,00 €
● F015H42A012	1.388,00 €
● F015H42A018	1.388,00 €
● F015H42A030	1.388,00 €
● F015H42A033	1.388,00 €

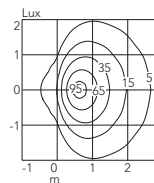
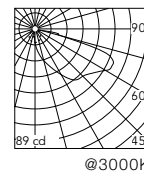

Mile Bollard 2 600 Mono

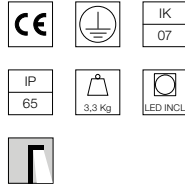
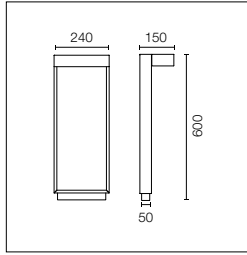

Source lumineuse LED incluse. Alimentation électrique 220-240V ON/OFF intégrée. Equipé d'un morceau de câble sortant en néoprène et d'un système avec joint anti-condensation IP68 H₂O à 2 voies. L'appareil peut être installé sur tous les sols à l'aide de chevilles. Plaque d'ancrage pour installation en surface avec socle en béton à commander séparément.

LED light source included. Integrated 220-240V ON/OFF electrical power. Equipped with a length of neoprene cable and an IP68 2-way anti-condensation H₂O stop seal system. The device may be installed on any flooring with anchors. Anchoring plate for installation on flooring laid over concrete sold separately.

2200K disponible sur demande.

2200K available on request.

Mid - Power Led: 7,8W - 838 lm ≠ FIXT 603 lm - 2700K/CRI 80 - 220-240V / 7,8W - 872 lm ≠ FIXT 627 lm - 3000K/CRI 80 - 220-240V / 7,8W - 905 lm ≠ FIXT 651 lm - 4000K/CRI 80 - 220-240V

2700K

Non Dimmable

○ F015J21A001	1.059,00 €
● F015J21A006	1.059,00 €
● F015J21A012	1.059,00 €
● F015J21A018	1.059,00 €
● F015J21A030	1.059,00 €
● F015J21A033	1.059,00 €
1-10V	
○ F015J21B001	1.118,00 €
● F015J21B006	1.118,00 €
● F015J21B012	1.118,00 €
● F015J21B018	1.118,00 €
● F015J21B030	1.118,00 €
● F015J21B033	1.118,00 €

Dali

○ F015J21D001	1.118,00 €
● F015J21D006	1.118,00 €
● F015J21D012	1.118,00 €
● F015J21D018	1.118,00 €
● F015J21D030	1.118,00 €
● F015J21D033	1.118,00 €

3000K

Non Dimmable

○ F015J31A001	1.059,00 €
● F015J31A006	1.059,00 €
● F015J31A012	1.059,00 €
● F015J31A018	1.059,00 €
● F015J31A030	1.059,00 €
● F015J31A033	1.059,00 €
1-10V	
○ F015J31B001	1.118,00 €
● F015J31B006	1.118,00 €
● F015J31B012	1.118,00 €
● F015J31B018	1.118,00 €
● F015J31B030	1.118,00 €
● F015J31B033	1.118,00 €

Dali

○ F015J31D001	1.118,00 €
● F015J31D006	1.118,00 €
● F015J31D012	1.118,00 €
● F015J31D018	1.118,00 €
● F015J31D030	1.118,00 €
● F015J31D033	1.118,00 €

4000K

Non Dimmable

○ F015J41A001	1.059,00 €
● F015J41A006	1.059,00 €
● F015J41A012	1.059,00 €
● F015J41A018	1.059,00 €
● F015J41A030	1.059,00 €
● F015J41A033	1.059,00 €
1-10V	
○ F015J41B001	1.118,00 €
● F015J41B006	1.118,00 €
● F015J41B012	1.118,00 €
● F015J41B018	1.118,00 €
● F015J41B030	1.118,00 €
● F015J41B033	1.118,00 €

Dali

○ F015J41D001	1.118,00 €
● F015J41D006	1.118,00 €
● F015J41D012	1.118,00 €
● F015J41D018	1.118,00 €
● F015J41D030	1.118,00 €
● F015J41D033	1.118,00 €

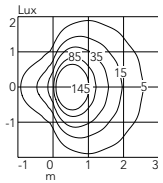
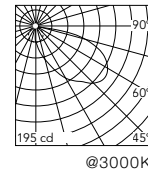

Mile Bollard 2 600 Double

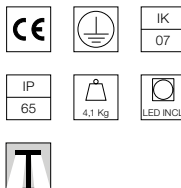
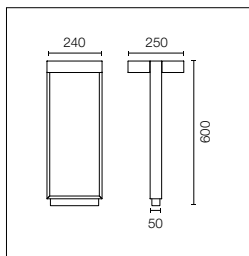

Source lumineuse LED incluse. Alimentation électrique 220-240V ON/OFF intégrée. Equipé d'un morceau de câble sortant en néoprène et d'un système avec joint anti-condensation IP68 H₂O à 2 voies. L'appareil peut être installé sur tous les sols à l'aide de chevilles. Plaque d'ancrage pour installation en surface avec socle en béton à commander séparément.

LED light source included. Integrated 220-240V ON/OFF electrical power. Equipped with a length of neoprene cable and an IP68 2-way anti-condensation H₂O stop seal system. The device may be installed on any flooring with anchors. Anchoring plate for installation on flooring laid over concrete sold separately.

2200K disponible sur demande.

2200K available on request.

Mid - Power Led: 15,6W - 2x838 lm ≠ FIXT 2x603 lm - 2700K/CRI 80 - 220-240V / 15,6W - 2x872 lm ≠ FIXT 2x627 lm - 3000K/CRI 80 - 220-240V / 15,6W - 2x905 lm ≠ FIXT 2x651 lm - 4000K/CRI 80 - 220-240V

2700K

Non Dimmable

- F015J22A001 1.388,00 €
- F015J22A006 1.388,00 €
- F015J22A012 1.388,00 €
- F015J22A018 1.388,00 €
- F015J22A030 1.388,00 €
- F015J22A033 1.388,00 €

1-10V

- F015J22B001 1.470,00 €
- F015J22B006 1.470,00 €
- F015J22B012 1.470,00 €
- F015J22B018 1.470,00 €
- F015J22B030 1.470,00 €
- F015J22B033 1.470,00 €

Dali

- F015J22D001 1.470,00 €
- F015J22D006 1.470,00 €
- F015J22D012 1.470,00 €
- F015J22D018 1.470,00 €
- F015J22D030 1.470,00 €
- F015J22D033 1.470,00 €

3000K

Non Dimmable

- F015J32A001 1.388,00 €
- F015J32A006 1.388,00 €
- F015J32A012 1.388,00 €
- F015J32A018 1.388,00 €
- F015J32A030 1.388,00 €
- F015J32A033 1.388,00 €

1-10V

- F015J32B001 1.470,00 €
- F015J32B006 1.470,00 €
- F015J32B012 1.470,00 €
- F015J32B018 1.470,00 €
- F015J32B030 1.470,00 €
- F015J32B033 1.470,00 €

Dali

- F015J32D001 1.470,00 €
- F015J32D006 1.470,00 €
- F015J32D012 1.470,00 €
- F015J32D018 1.470,00 €
- F015J32D030 1.470,00 €
- F015J32D033 1.470,00 €

4000K

Non Dimmable

- F015J42A001 1.388,00 €
- F015J42A006 1.388,00 €
- F015J42A012 1.388,00 €
- F015J42A018 1.388,00 €
- F015J42A030 1.388,00 €
- F015J42A033 1.388,00 €

1-10V

- F015J42B001 1.470,00 €
- F015J42B006 1.470,00 €
- F015J42B012 1.470,00 €
- F015J42B018 1.470,00 €
- F015J42B030 1.470,00 €
- F015J42B033 1.470,00 €

Dali

- F015J42D001 1.470,00 €
- F015J42D006 1.470,00 €
- F015J42D012 1.470,00 €
- F015J42D018 1.470,00 €
- F015J42D030 1.470,00 €
- F015J42D033 1.470,00 €

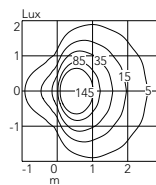
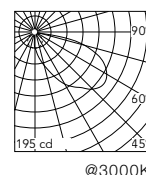

Mile Bollard 2 900 Mono

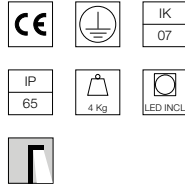
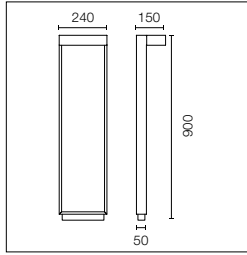

Source lumineuse LED incluse.
Alimentation électrique 220-240V ON/OFF et dimmable 1-10V ou DALI intégrée.
Equipé d'un morceau de câble sortant en néoprène et d'un système avec joint anti-condensation IP68 H₂O à 2 voies. L'appareil peut être installé sur tous les sols à l'aide de chevilles. Plaque d'ancrage pour installation en surface avec socle en béton à commander séparément.

LED light source included.
Integrated 220-240V ON/OFF and 1-10V or DALI dimmable electrical power. Equipped with a length of neoprene cable and an IP68 2-way anti-condensation H₂O stop seal system. The device may be installed on any flooring with anchors. Anchoring plate for installation on flooring laid over concrete sold separately.

2200K disponible sur demande.

2200K available on request.

Mid - Power Led: 7,8W - 838 lm ≠ FIXT 603 lm - 2700K/CRI 80 - 220-240V / 7,8W - 872 lm ≠ FIXT 627 lm - 3000K/CRI 80 - 220-240V / 7,8W - 905 lm ≠ FIXT 651 lm - 4000K/CRI 80 - 220-240V

2700K

Non Dimmable

○ F015K21A001	1.166,00 €
● F015K21A006	1.166,00 €
● F015K21A012	1.166,00 €
● F015K21A018	1.166,00 €
● F015K21A030	1.166,00 €
● F015K21A033	1.166,00 €
1-10V	
○ F015K21B001	1.225,00 €
● F015K21B006	1.225,00 €
● F015K21B012	1.225,00 €
● F015K21B018	1.225,00 €
● F015K21B030	1.225,00 €
● F015K21B033	1.225,00 €
Dali	
○ F015K21D001	1.225,00 €
● F015K21D006	1.225,00 €
● F015K21D012	1.225,00 €
● F015K21D018	1.225,00 €
● F015K21D030	1.225,00 €
● F015K21D033	1.225,00 €

3000K

Non Dimmable

○ F015K31A001	1.166,00 €
● F015K31A006	1.166,00 €
● F015K31A012	1.166,00 €
● F015K31A018	1.166,00 €
● F015K31A030	1.166,00 €
● F015K31A033	1.166,00 €
1-10V	
○ F015K31B001	1.225,00 €
● F015K31B006	1.225,00 €
● F015K31B012	1.225,00 €
● F015K31B018	1.225,00 €
● F015K31B030	1.225,00 €
● F015K31B033	1.225,00 €
Dali	
○ F015K31D001	1.225,00 €
● F015K31D006	1.225,00 €
● F015K31D012	1.225,00 €
● F015K31D018	1.225,00 €
● F015K31D030	1.225,00 €
● F015K31D033	1.225,00 €

4000K

Non Dimmable

○ F015K41A001	1.166,00 €
● F015K41A006	1.166,00 €
● F015K41A012	1.166,00 €
● F015K41A018	1.166,00 €
● F015K41A030	1.166,00 €
● F015K41A033	1.166,00 €
1-10V	
○ F015K41B001	1.225,00 €
● F015K41B006	1.225,00 €
● F015K41B012	1.225,00 €
● F015K41B018	1.225,00 €
● F015K41B030	1.225,00 €
● F015K41B033	1.225,00 €
Dali	
○ F015K41D001	1.225,00 €
● F015K41D006	1.225,00 €
● F015K41D012	1.225,00 €
● F015K41D018	1.225,00 €
● F015K41D030	1.225,00 €
● F015K41D033	1.225,00 €

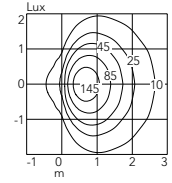
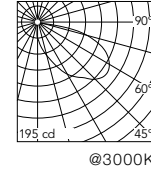

Mile Bollard 2 900 Double

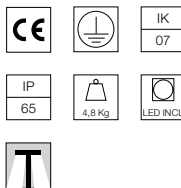
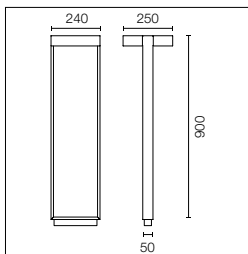

Source lumineuse LED incluse. Alimentation électrique 220-240V ON/OFF et dimmable 1-10V ou DALI intégrée. Equipé d'un morceau de câble sortant en néoprène et d'un système avec joint anti-condensation IP68 H₂O à 2 voies. L'appareil peut être installé sur tous les sols à l'aide de chevilles. Plaque d'ancrage pour installation en surface avec socle en béton à commander séparément.

LED light source included. Integrated 220-240V ON/OFF electrical power. Equipped with a length of neoprene cable and an IP68 2-way anti-condensation H₂O stop seal system. The device may be installed on any flooring with anchors. Anchoring plate for installation on flooring laid over concrete sold separately.

2200K disponible sur demande.

2200K available on request.

Mid - Power Led: 15,6W - 2x838 lm ≠ FIXT 2x603 lm - 2700K/CRI 80 - 220-240V / 15,6W - 2x872 lm ≠ FIXT 2x627 lm - 3000K/CRI 80 - 220-240V / 15,6W - 2x905 lm ≠ FIXT 2x651 lm - 4000K/CRI 80 - 220-240V

2700K

Non Dimmable

○ F015K22A001	1.493,00 €
● F015K22A006	1.493,00 €
● F015K22A012	1.493,00 €
● F015K22A018	1.493,00 €
● F015K22A030	1.493,00 €
● F015K22A033	1.493,00 €
1-10V	
○ F015K22B001	1.577,00 €
● F015K22B006	1.577,00 €
● F015K22B012	1.577,00 €
● F015K22B018	1.577,00 €
● F015K22B030	1.577,00 €
● F015K22B033	1.577,00 €
Dali	
○ F015K22D001	1.577,00 €
● F015K22D006	1.577,00 €
● F015K22D012	1.577,00 €
● F015K22D018	1.577,00 €
● F015K22D030	1.577,00 €
● F015K22D033	1.577,00 €

3000K

Non Dimmable

○ F015K32A001	1.493,00 €
● F015K32A006	1.493,00 €
● F015K32A012	1.493,00 €
● F015K32A018	1.493,00 €
● F015K32A030	1.493,00 €
● F015K32A033	1.493,00 €
1-10V	
○ F015K32B001	1.577,00 €
● F015K32B006	1.577,00 €
● F015K32B012	1.577,00 €
● F015K32B018	1.577,00 €
● F015K32B030	1.577,00 €
● F015K32B033	1.577,00 €
Dali	
○ F015K32D001	1.577,00 €
● F015K32D006	1.577,00 €
● F015K32D012	1.577,00 €
● F015K32D018	1.577,00 €
● F015K32D030	1.577,00 €
● F015K32D033	1.577,00 €

4000K

Non Dimmable

○ F015K42A001	1.493,00 €
● F015K42A006	1.493,00 €
● F015K42A012	1.493,00 €
● F015K42A018	1.493,00 €
● F015K42A030	1.493,00 €
● F015K42A033	1.493,00 €
1-10V	
○ F015K42B001	1.577,00 €
● F015K42B006	1.577,00 €
● F015K42B012	1.577,00 €
● F015K42B018	1.577,00 €
● F015K42B030	1.577,00 €
● F015K42B033	1.577,00 €
Dali	
○ F015K42D001	1.577,00 €
● F015K42D006	1.577,00 €
● F015K42D012	1.577,00 €
● F015K42D018	1.577,00 €
● F015K42D030	1.577,00 €
● F015K42D033	1.577,00 €

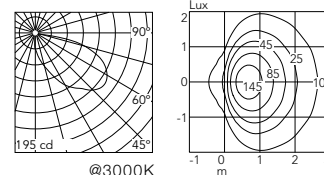

Mile Bollard: Accessoires / Accessories

Plaque de boulons.

Base plate with bolt.

Bollard 1

F015Z000000 37,00 €



Plaque de boulons.

Base plate with bolt.

Bollard 2

F015Z010000 39,00 €



Dispositif de protection contre les surtensions. 275Vac. Courant de décharge maximal 10KA (8/20us). Courant de fonctionnement maximal 5A. Adapté pour les connexions en séries. IP66.

Surge protection device. 275Vac. Maximum discharge current 10KA (8/20us). Maximum operating current 5A. Suitable for series connection. IP66.

F990E00A000 116,00 €

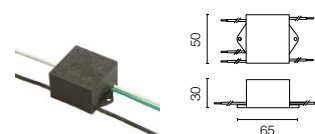

Mile Path 1

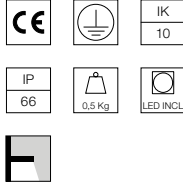
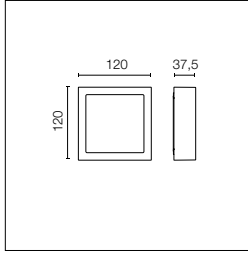

Source de lumière LED incluse.
Source d'alimentation intégrée
220-240V ON/OFF.
Équipé de doubles passe-fils
pour la connexion d'entrée et
de sortie. Support de fixation
inclus.

LED light source included.
Integrated 220–240 V ON/OFF
electrical power.
Equipped with double cable
gland for inlet and outlet
connection. Fixing bracket
included.

2200K disponible sur demande.

2200K available on request.

Mid - Power Led: 4,9W - 422 lm ≠ FIXT 100 lm - 2700K/CRI>80 - 220-240V / 4,9W - 439 lm ≠ FIXT 104 lm - 3000K/CRI>80 - 220-240V /
4,9W - 456 lm ≠ FIXT 108 lm - 4000/CRI>80 - 220-240V

2700K

○ F015L20A000	315,00 €
○ F015L20A001	315,00 €
● F015L20A006	315,00 €
● F015L20A012	315,00 €
● F015L20A018	315,00 €
● F015L20A030	315,00 €
● F015L20A033	315,00 €

3000K

○ F015L30A000	315,00 €
○ F015L30A001	315,00 €
● F015L30A006	315,00 €
● F015L30A012	315,00 €
● F015L30A018	315,00 €
● F015L30A030	315,00 €
● F015L30A033	315,00 €

4000K

○ F015L40A000	315,00 €
○ F015L40A001	315,00 €
● F015L40A006	315,00 €
● F015L40A012	315,00 €
● F015L40A018	315,00 €
● F015L40A030	315,00 €
● F015L40A033	315,00 €

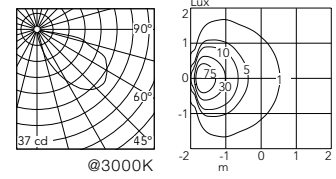

Mile Path 2

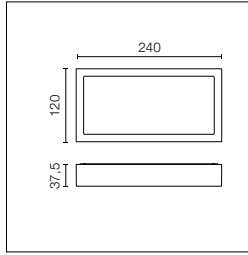

Source de lumière LED incluse.
Alimentation électrique intégrée
220-240V ON/OFF ou réglable
1-10V / DALI.
Équipé de passe-fils pour une
connexion sécurisée avec
étanchéité IP. Support de
fixation inclus.

LED light source included.
Integrated 220-240V ON/OFF
and 1-10V/DALI dimmable
electrical power.
Equipped with a cable gland
for safety connection with
IP tightness. Fixing bracket
included.

2200K disponible sur demande.

2200K available on request.

Mid - Power Led: 7,6W - 818 lm ≠ FIXT 172 lm - 2700K/CRI>80 - 220-240V / 7,6W - 850 lm ≠ FIXT 179 lm - 3000K/CRI>80 - 220-240V / 7,6W - 883 lm ≠ FIXT 186 lm - 4000K/CRI>80 - 220-240V

2700K

Non Dimmable

○ F015M20A000	416,00 €
○ F015M20A001	416,00 €
● F015M20A006	416,00 €
● F015M20A012	416,00 €
● F015M20A018	416,00 €
● F015M20A030	416,00 €
● F015M20A033	416,00 €
1-10V	
○ F015M20B000	501,00 €
○ F015M20B001	501,00 €
● F015M20B006	501,00 €
● F015M20B012	501,00 €
● F015M20B018	501,00 €
● F015M20B030	501,00 €
● F015M20B033	501,00 €
Dali	
○ F015M20D000	501,00 €
○ F015M20D001	501,00 €
● F015M20D006	501,00 €
● F015M20D012	501,00 €
● F015M20D018	501,00 €
● F015M20D030	501,00 €
● F015M20D033	501,00 €

3000K

Non Dimmable

○ F015M30A000	416,00 €
○ F015M30A001	416,00 €
● F015M30A006	416,00 €
● F015M30A012	416,00 €
● F015M30A018	416,00 €
● F015M30A030	416,00 €
● F015M30A033	416,00 €
1-10V	
○ F015M30B000	501,00 €
○ F015M30B001	501,00 €
● F015M30B006	501,00 €
● F015M30B012	501,00 €
● F015M30B018	501,00 €
● F015M30B030	501,00 €
● F015M30B033	501,00 €
Dali	
○ F015M30D000	501,00 €
○ F015M30D001	501,00 €
● F015M30D006	501,00 €
● F015M30D012	501,00 €
● F015M30D018	501,00 €
● F015M30D030	501,00 €
● F015M30D033	501,00 €

4000K

Non Dimmable

○ F015M40A000	416,00 €
○ F015M40A001	416,00 €
● F015M40A006	416,00 €
● F015M40A012	416,00 €
● F015M40A018	416,00 €
● F015M40A030	416,00 €
● F015M40A033	416,00 €
1-10V	
○ F015M40B000	501,00 €
○ F015M40B001	501,00 €
● F015M40B006	501,00 €
● F015M40B012	501,00 €
● F015M40B018	501,00 €
● F015M40B030	501,00 €
● F015M40B033	501,00 €
Dali	
○ F015M40D000	501,00 €
○ F015M40D001	501,00 €
● F015M40D006	501,00 €
● F015M40D012	501,00 €
● F015M40D018	501,00 €
● F015M40D030	501,00 €
● F015M40D033	501,00 €

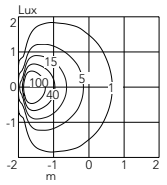
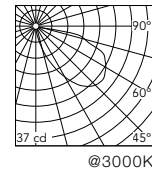

* Spécifications techniques et photométries préliminaires. / Preliminary technical specs and photometries.

Mile Wall 1 Asymmetric Up

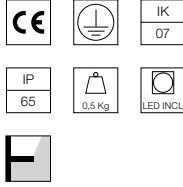
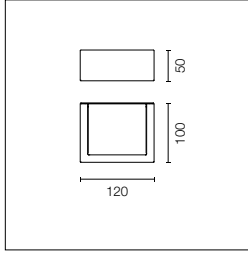

Source lumineuse LED incluse.
Alimentation électrique 220-240V ON/OFF intégrée. Equipé d'un double pressecâble pour connexion entrée-sortie.

LED light source included.
Integrated 220-240V ON/OFF electrical power. Equipped with double cable gland for electrical connection.

2200K disponible sur demande.

2200K available on request.

Mid - Power Led: 4,9W - 427 lm ≠ FIXT 283 lm - 2700K/CRI 80 - 220-240V / 4,9W - 445 lm ≠ FIXT 294 lm - 3000K/CRI 80 - 220-240V / 4,9W - 462 lm ≠ FIXT 305 lm - 4000K/CRI 80 - 220-240V

2700K		3000K		4000K	
○ F015A21A000	235,00 €	○ F015A31A000	235,00 €	○ F015A41A000	235,00 €
○ F015A21A001	235,00 €	○ F015A31A001	235,00 €	○ F015A41A001	235,00 €
● F015A21A006	235,00 €	● F015A31A006	235,00 €	● F015A41A006	235,00 €
● F015A21A012	235,00 €	● F015A31A012	235,00 €	● F015A41A012	235,00 €
● F015A21A018	235,00 €	● F015A31A018	235,00 €	● F015A41A018	235,00 €
● F015A21A030	235,00 €	● F015A31A030	235,00 €	● F015A41A030	235,00 €
● F015A21A033	235,00 €	● F015A31A033	235,00 €	● F015A41A033	235,00 €

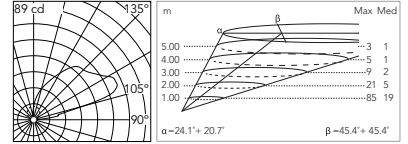

@3000K

Mile Wall 1 Asymmetric Down

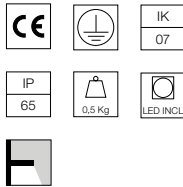
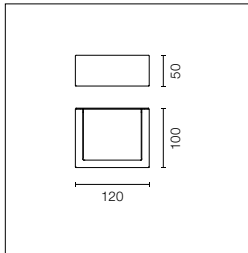

Source lumineuse LED incluse.
Alimentation électrique 220-240V ON/OFF intégrée. Equipé d'un double pressecâble pour connexion entrée-sortie.

LED light source included.
Integrated 220-240V ON/OFF electrical power. Equipped with double cable gland for electrical connection.

2200K disponible sur demande.

2200K available on request.

Mid - Power Led: 4,9W - 427 lm ≠ FIXT 283 lm - 2700K/CRI 80 - 220-240V / 4,9W - 445 lm ≠ FIXT 294 lm - 3000K/CRI 80 - 220-240V / 4,9W - 462 lm ≠ FIXT 305 lm - 4000K/CRI 80 - 220-240V

2700K		3000K		4000K	
○ F015A22A000	235,00 €	○ F015A32A000	235,00 €	○ F015A42A000	235,00 €
○ F015A22A001	235,00 €	○ F015A32A001	235,00 €	○ F015A42A001	235,00 €
● F015A22A006	235,00 €	● F015A32A006	235,00 €	● F015A42A006	235,00 €
● F015A22A012	235,00 €	● F015A32A012	235,00 €	● F015A42A012	235,00 €
● F015A22A018	235,00 €	● F015A32A018	235,00 €	● F015A42A018	235,00 €
● F015A22A030	235,00 €	● F015A32A030	235,00 €	● F015A42A030	235,00 €
● F015A22A033	235,00 €	● F015A32A033	235,00 €	● F015A42A033	235,00 €

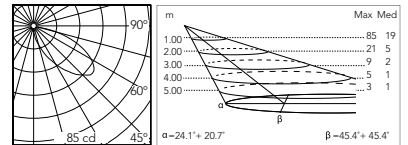

@3000K

Mile Wall 1 Washer Up

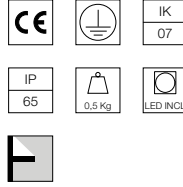
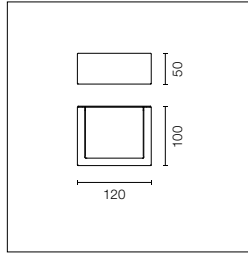

Source lumineuse LED incluse.
Alimentation électrique 220-240V ON/OFF intégrée. Equipé d'un double pressécâble pour connexion entrée-sortie.

LED light source included.
Integrated 220-240V ON/OFF electrical power. Equipped with double cable gland for electrical connection.

2200K disponible sur demande.

2200K available on request.

Mid - Power Led: 4,9W - 427 lm ≠ FIXT 291 lm - 2700K/CRI 80 - 220-240V / 4,9W - 445 lm ≠ FIXT 303 lm - 3000K/CRI 80 - 220-240V / 4,9W - 462 lm ≠ FIXT 314 lm - 4000K/CRI 80 - 220-240V

2700K		3000K		4000K	
○ F015B21A000	235,00 €	○ F015B31A000	235,00 €	○ F015B41A000	235,00 €
○ F015B21A001	235,00 €	○ F015B31A001	235,00 €	○ F015B41A001	235,00 €
● F015B21A006	235,00 €	● F015B31A006	235,00 €	● F015B41A006	235,00 €
● F015B21A012	235,00 €	● F015B31A012	235,00 €	● F015B41A012	235,00 €
● F015B21A018	235,00 €	● F015B31A018	235,00 €	● F015B41A018	235,00 €
● F015B21A030	235,00 €	● F015B31A030	235,00 €	● F015B41A030	235,00 €
● F015B21A033	235,00 €	● F015B31A033	235,00 €	● F015B41A033	235,00 €

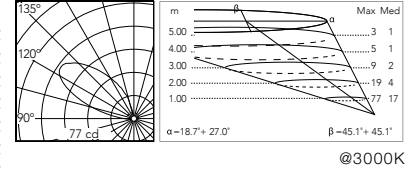

Mile Wall 1 Washer Down

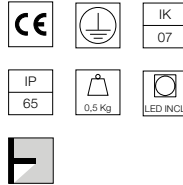
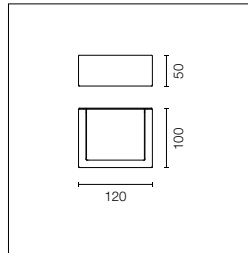

Source lumineuse LED incluse.
Alimentation électrique 220-240V ON/OFF intégrée. Equipé d'un double pressécâble pour connexion entrée-sortie.

LED light source included.
Integrated 220-240V ON/OFF electrical power. Equipped with double cable gland for electrical connection.

2200K disponible sur demande.

2200K available on request.

Mid - Power Led: 4,9W - 427 lm ≠ FIXT 291 lm - 2700K/CRI 80 - 220-240V / 4,9W - 445 lm ≠ FIXT 303 lm - 3000K/CRI 80 - 220-240V / 4,9W - 462 lm ≠ FIXT 314 lm - 4000K/CRI 80 - 220-240V

2700K		3000K		4000K	
○ F015B22A000	235,00 €	○ F015B32A000	235,00 €	○ F015B42A000	235,00 €
○ F015B22A001	235,00 €	○ F015B32A001	235,00 €	○ F015B42A001	235,00 €
● F015B22A006	235,00 €	● F015B32A006	235,00 €	● F015B42A006	235,00 €
● F015B22A012	235,00 €	● F015B32A012	235,00 €	● F015B42A012	235,00 €
● F015B22A018	235,00 €	● F015B32A018	235,00 €	● F015B42A018	235,00 €
● F015B22A030	235,00 €	● F015B32A030	235,00 €	● F015B42A030	235,00 €
● F015B22A033	235,00 €	● F015B32A033	235,00 €	● F015B42A033	235,00 €

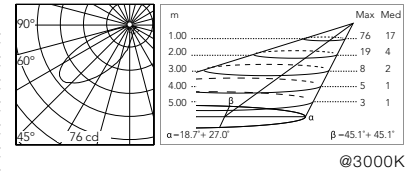

Mile Wall 1 Asymmetric Up & Down

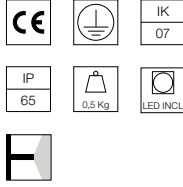
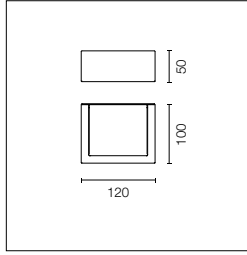

Source lumineuse LED incluse.
Alimentation électrique 220-240V ON/OFF intégrée. Equipé d'un double pressecâble pour connexion entrée-sortie.

LED light source included.
Integrated 220-240V ON/OFF electrical power. Equipped with double cable gland for electrical connection.

2200K disponible sur demande.

2200K available on request.

Mid - Power Led: 8,1W - 2x427 lm ≠ FIXT 2x291 lm - 2700K/CRI 80 - 220-240V / 8,1W - 2x445 lm ≠ FIXT 2x303 lm - 3000K/CRI 80 - 220-240V / 8,1W - 2x462 lm ≠ FIXT 2x314 lm - 4000K/CRI 80 - 220-240V

2700K

○ F015A23A000	270,00 €
○ F015A23A001	270,00 €
● F015A23A006	270,00 €
● F015A23A012	270,00 €
● F015A23A018	270,00 €
● F015A23A030	270,00 €
● F015A23A033	270,00 €

3000K

○ F015A33A000	270,00 €
○ F015A33A001	270,00 €
● F015A33A006	270,00 €
● F015A33A012	270,00 €
● F015A33A018	270,00 €
● F015A33A030	270,00 €
● F015A33A033	270,00 €

4000K

○ F015A43A000	270,00 €
○ F015A43A001	270,00 €
● F015A43A006	270,00 €
● F015A43A012	270,00 €
● F015A43A018	270,00 €
● F015A43A030	270,00 €
● F015A43A033	270,00 €

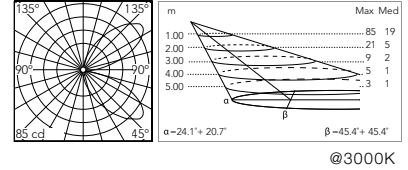

Mile Wall 1 Washer Up & Down

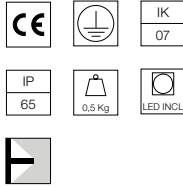
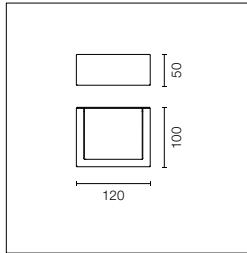

Source lumineuse LED incluse.
Alimentation électrique 220-240V ON/OFF intégrée. Equipé d'un double pressecâble pour connexion entrée-sortie.

LED light source included.
Integrated 220-240V ON/OFF electrical power. Equipped with double cable gland for electrical connection.

2200K disponible sur demande.

2200K available on request.

Mid - Power Led: 8,1W - 2x427 lm ≠ FIXT 2x291 lm - 2700K/CRI 80 - 220-240V / 8,1W - 2x445 lm ≠ FIXT 2x303 lm - 3000K/CRI 80 - 220-240V / 8,1W - 2x462 lm ≠ FIXT 2x314 lm - 4000K/CRI 80 - 220-240V

2700K

○ F015B23A000	270,00 €
○ F015B23A001	270,00 €
● F015B23A006	270,00 €
● F015B23A012	270,00 €
● F015B23A018	270,00 €
● F015B23A030	270,00 €
● F015B23A033	270,00 €

3000K

○ F015B33A000	270,00 €
○ F015B33A001	270,00 €
● F015B33A006	270,00 €
● F015B33A012	270,00 €
● F015B33A018	270,00 €
● F015B33A030	270,00 €
● F015B33A033	270,00 €

4000K

○ F015B43A000	270,00 €
○ F015B43A001	270,00 €
● F015B43A006	270,00 €
● F015B43A012	270,00 €
● F015B43A018	270,00 €
● F015B43A030	270,00 €
● F015B43A033	270,00 €

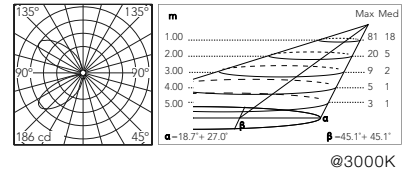

Mile Wall 1 Washer Down + Asymmetric Up

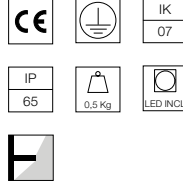
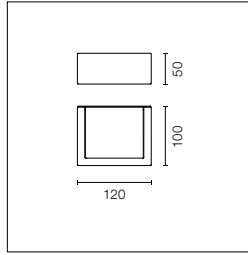

Source lumineuse LED incluse. Alimentation électrique 220-240V ON/OFF intégrée. Equipé d'un double pressécâble pour connexion entrée-sortie.

LED light source included. Integrated 220-240V ON/OFF electrical power. Equipped with double cable gland for electrical connection.

2200K disponible sur demande.

2200K available on request.

Mid - Power Led: 8,1W - 2x427 lm ≠ FIXT 291+283 lm - 2700K/CRI 80 - 220-240V / 8,1W - 2x445 lm ≠ FIXT 303+294 lm - 3000K/CRI 80 - 220-240V / 8,1W - 2x462 lm ≠ FIXT 314+305 lm - 4000K/CRI 80 - 220-240V

2700K		3000K		4000K	
○ F015C24A000	270,00 €	○ F015C34A000	270,00 €	○ F015C44A000	270,00 €
○ F015C24A001	270,00 €	○ F015C34A001	270,00 €	○ F015C44A001	270,00 €
● F015C24A006	270,00 €	● F015C34A006	270,00 €	● F015C44A006	270,00 €
● F015C24A012	270,00 €	● F015C34A012	270,00 €	● F015C44A012	270,00 €
● F015C24A018	270,00 €	● F015C34A018	270,00 €	● F015C44A018	270,00 €
● F015C24A030	270,00 €	● F015C34A030	270,00 €	● F015C44A030	270,00 €
● F015C24A033	270,00 €	● F015C34A033	270,00 €	● F015C44A033	270,00 €

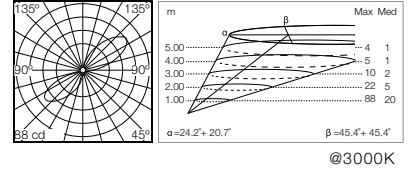

Mile Wall 2 Asymmetric Up

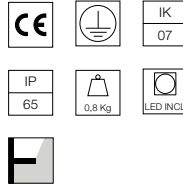
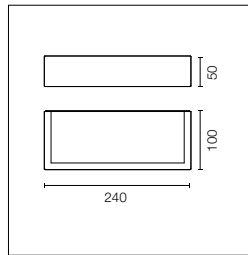

Source lumineuse LED incluse. Alimentation électrique 220-240V ON/OFF et dimmable 1-10V ou DALI intégrée. Equipé d'un double pressécâble pour connexion entrée-sortie.

LED light source included. Integrated 220-240V ON/OFF and 1-10V or DALI dimmable electrical power. Equipped with double cable gland for electrical connection.

2200K disponible sur demande.

2200K available on request.

Mid - Power Led: 7,8W - 838 lm ≠ FIXT 603 lm - 2700K/CRI 80 - 220-240V / 7,8W - 872 lm ≠ FIXT 627 lm - 3000K/CRI 80 - 220-240V / 7,8W - 905 lm ≠ FIXT 651 lm - 4000K/CRI 80 - 220-240V

2700K		3000K		4000K	
Non Dimmable		Non Dimmable		Non Dimmable	
○ F015D21A000	272,00 €	○ F015D31A000	272,00 €	○ F015D41A000	272,00 €
○ F015D21A001	272,00 €	○ F015D31A001	272,00 €	○ F015D41A001	272,00 €
● F015D21A006	272,00 €	● F015D31A006	272,00 €	● F015D41A006	272,00 €
● F015D21A012	272,00 €	● F015D31A012	272,00 €	● F015D41A012	272,00 €
● F015D21A018	272,00 €	● F015D31A018	272,00 €	● F015D41A018	272,00 €
● F015D21A030	272,00 €	● F015D31A030	272,00 €	● F015D41A030	272,00 €
● F015D21A033	272,00 €	● F015D31A033	272,00 €	● F015D41A033	272,00 €
1-10V		1-10V		1-10V	
○ F015D21B000	331,00 €	○ F015D31B000	331,00 €	○ F015D41B000	331,00 €
○ F015D21B001	331,00 €	○ F015D31B001	331,00 €	○ F015D41B001	331,00 €
● F015D21B006	331,00 €	● F015D31B006	331,00 €	● F015D41B006	331,00 €
● F015D21B012	331,00 €	● F015D31B012	331,00 €	● F015D41B012	331,00 €
● F015D21B018	331,00 €	● F015D31B018	331,00 €	● F015D41B018	331,00 €
● F015D21B030	331,00 €	● F015D31B030	331,00 €	● F015D41B030	331,00 €
● F015D21B033	331,00 €	● F015D31B033	331,00 €	● F015D41B033	331,00 €
Dali		Dali		Dali	
○ F015D21D000	331,00 €	○ F015D31D000	331,00 €	○ F015D41D000	331,00 €
○ F015D21D001	331,00 €	○ F015D31D001	331,00 €	○ F015D41D001	331,00 €
● F015D21D006	331,00 €	● F015D31D006	331,00 €	● F015D41D006	331,00 €
● F015D21D012	331,00 €	● F015D31D012	331,00 €	● F015D41D012	331,00 €
● F015D21D018	331,00 €	● F015D31D018	331,00 €	● F015D41D018	331,00 €
● F015D21D030	331,00 €	● F015D31D030	331,00 €	● F015D41D030	331,00 €
● F015D21D033	331,00 €	● F015D31D033	331,00 €	● F015D41D033	331,00 €

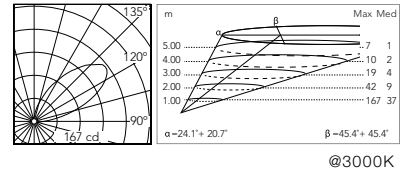

Mile Wall 2 Asymmetric Down

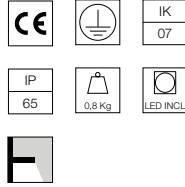
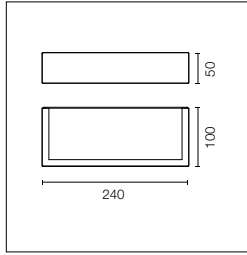

Source lumineuse LED incluse. Alimentation électrique 220-240V ON/OFF et dimmable 1-10V ou DALI intégrée. Equipé d'un double pressecâble pour connexion entrée-sortie.

LED light source included. Integrated 220-240V ON/OFF and 1-10V or DALI dimmable electrical power. Equipped with double cable gland for electrical connection.

2200K disponible sur demande.

2200K available on request.

Mid - Power Led: 7,8W - 838 lm ≠ FIXT 603 lm - 2700K/CRI 80 - 220-240V / 7,8W - 872 lm ≠ FIXT 627 lm - 3000K/CRI 80 - 220-240V / 7,8W - 905 lm ≠ FIXT 651 lm - 4000K/CRI 80 - 220-240V

2700K

Non Dimmable

○ F015D22A000	272,00 €
○ F015D22A001	272,00 €
● F015D22A006	272,00 €
● F015D22A012	272,00 €
● F015D22A018	272,00 €
● F015D22A030	272,00 €
● F015D22A033	272,00 €
1-10V	
○ F015D22B000	331,00 €
○ F015D22B001	331,00 €
● F015D22B006	331,00 €
● F015D22B012	331,00 €
● F015D22B018	331,00 €
● F015D22B030	331,00 €
● F015D22B033	331,00 €

Dali

○ F015D22D000	331,00 €
○ F015D22D001	331,00 €
● F015D22D006	331,00 €
● F015D22D012	331,00 €
● F015D22D018	331,00 €
● F015D22D030	331,00 €
● F015D22D033	331,00 €

3000K

Non Dimmable

○ F015D32A000	272,00 €
○ F015D32A001	272,00 €
● F015D32A006	272,00 €
● F015D32A012	272,00 €
● F015D32A018	272,00 €
● F015D32A030	272,00 €
● F015D32A033	272,00 €
1-10V	
○ F015D32B000	331,00 €
○ F015D32B001	331,00 €
● F015D32B006	331,00 €
● F015D32B012	331,00 €
● F015D32B018	331,00 €
● F015D32B030	331,00 €
● F015D32B033	331,00 €

Dali

○ F015D32D000	331,00 €
○ F015D32D001	331,00 €
● F015D32D006	331,00 €
● F015D32D012	331,00 €
● F015D32D018	331,00 €
● F015D32D030	331,00 €
● F015D32D033	331,00 €

4000K

Non Dimmable

○ F015D42A000	272,00 €
○ F015D42A001	272,00 €
● F015D42A006	272,00 €
● F015D42A012	272,00 €
● F015D42A018	272,00 €
● F015D42A030	272,00 €
● F015D42A033	272,00 €
1-10V	
○ F015D42B000	331,00 €
○ F015D42B001	331,00 €
● F015D42B006	331,00 €
● F015D42B012	331,00 €
● F015D42B018	331,00 €
● F015D42B030	331,00 €
● F015D42B033	331,00 €

Dali

○ F015D42D000	331,00 €
○ F015D42D001	331,00 €
● F015D42D006	331,00 €
● F015D42D012	331,00 €
● F015D42D018	331,00 €
● F015D42D030	331,00 €
● F015D42D033	331,00 €

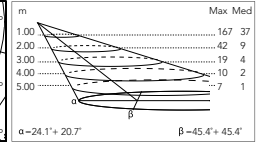
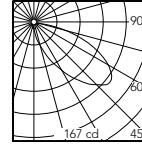

@3000K

Mile Wall 2 Washer Up

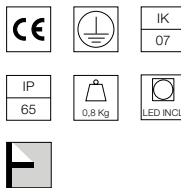
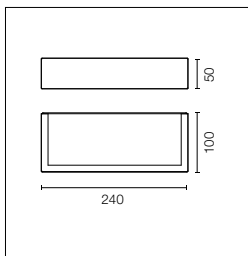

Source lumineuse LED incluse. Alimentation électrique 220-240V ON/OFF et dimmable 1-10V ou DALI intégrée. Equipé d'un double pressecâble pour connexion entrée-sortie.

LED light source included. Integrated 220-240V ON/OFF and 1-10V or DALI dimmable electrical power. Equipped with double cable gland for electrical connection.

2200K disponible sur demande.

2200K available on request.

Mid - Power Led: 6,4W - 661 lm ≠ FIXT 453 lm - 2700K/CRI 80 - 220-240V / 6,4W - 714 lm ≠ FIXT 471 lm - 3000K/CRI 80 - 220-240V / 6,4W - 714 lm ≠ FIXT 489 lm - 4000K/CRI 80 - 220-240V

2700K		3000K		4000K	
Non Dimmable		Non Dimmable		Non Dimmable	
○ F015E21A000	272,00 €	○ F015E31A000	272,00 €	○ F015E41A000	272,00 €
○ F015E21A001	272,00 €	○ F015E31A001	272,00 €	○ F015E41A001	272,00 €
● F015E21A006	272,00 €	● F015E31A006	272,00 €	● F015E41A006	272,00 €
● F015E21A012	272,00 €	● F015E31A012	272,00 €	● F015E41A012	272,00 €
● F015E21A018	272,00 €	● F015E31A018	272,00 €	● F015E41A018	272,00 €
● F015E21A030	272,00 €	● F015E31A030	272,00 €	● F015E41A030	272,00 €
● F015E21A033	272,00 €	● F015E31A033	272,00 €	● F015E41A033	272,00 €
1-10V		1-10V		1-10V	
○ F015E21B000	331,00 €	○ F015E31B000	331,00 €	○ F015E41B000	331,00 €
○ F015E21B001	331,00 €	○ F015E31B001	331,00 €	○ F015E41B001	331,00 €
● F015E21B006	331,00 €	● F015E31B006	331,00 €	● F015E41B006	331,00 €
● F015E21B012	331,00 €	● F015E31B012	331,00 €	● F015E41B012	331,00 €
● F015E21B018	331,00 €	● F015E31B018	331,00 €	● F015E41B018	331,00 €
● F015E21B030	331,00 €	● F015E31B030	331,00 €	● F015E41B030	331,00 €
● F015E21B033	331,00 €	● F015E31B033	331,00 €	● F015E41B033	331,00 €
Dali		Dali		Dali	
○ F015E21D000	331,00 €	○ F015E31D000	331,00 €	○ F015E41D000	331,00 €
○ F015E21D001	331,00 €	○ F015E31D001	331,00 €	○ F015E41D001	331,00 €
● F015E21D006	331,00 €	● F015E31D006	331,00 €	● F015E41D006	331,00 €
● F015E21D012	331,00 €	● F015E31D012	331,00 €	● F015E41D012	331,00 €
● F015E21D018	331,00 €	● F015E31D018	331,00 €	● F015E41D018	331,00 €
● F015E21D030	331,00 €	● F015E31D030	331,00 €	● F015E41D030	331,00 €
● F015E21D033	331,00 €	● F015E31D033	331,00 €	● F015E41D033	331,00 €

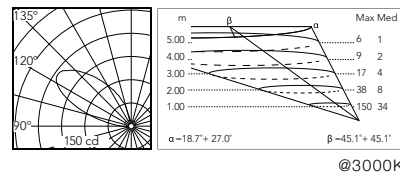

@3000K

Mile Wall 2 Washer Down

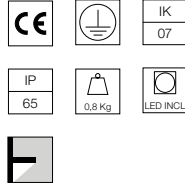
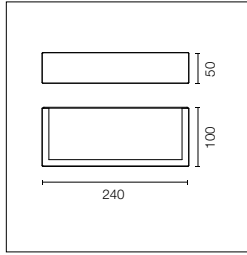

Source lumineuse LED incluse. Alimentation électrique 220-240V ON/OFF et dimmable 1-10V ou DALI intégrée. Equipé d'un double pressecâble pour connexion entrée-sortie.

LED light source included. Integrated 220-240V ON/OFF and 1-10V or DALI dimmable electrical power. Equipped with double cable gland for electrical connection.

2200K disponible sur demande.

2200K available on request.

Mid - Power Led: 6,4W - 661 lm ≠ FIXT 453 lm - 2700K/CRI 80 - 220-240V / 6,4W - 714 lm ≠ FIXT 471 lm - 3000K/CRI 80 - 220-240V / 6,4W - 714 lm ≠ FIXT 489 lm - 4000K/CRI 80 - 220-240V

2700K

Non Dimmable

○ F015E22A000	272,00 €
○ F015E22A001	272,00 €
● F015E22A006	272,00 €
● F015E22A012	272,00 €
● F015E22A018	272,00 €
● F015E22A030	272,00 €
● F015E22A033	272,00 €
1-10V	
○ F015E22B000	331,00 €
○ F015E22B001	331,00 €
● F015E22B006	331,00 €
● F015E22B012	331,00 €
● F015E22B018	331,00 €
● F015E22B030	331,00 €
● F015E22B033	331,00 €

Dali

○ F015E22D000	331,00 €
○ F015E22D001	331,00 €
● F015E22D006	331,00 €
● F015E22D012	331,00 €
● F015E22D018	331,00 €
● F015E22D030	331,00 €
● F015E22D033	331,00 €

3000K

Non Dimmable

○ F015E32A000	272,00 €
○ F015E32A001	272,00 €
● F015E32A006	272,00 €
● F015E32A012	272,00 €
● F015E32A018	272,00 €
● F015E32A030	272,00 €
● F015E32A033	272,00 €
1-10V	
○ F015E32B000	331,00 €
○ F015E32B001	331,00 €
● F015E32B006	331,00 €
● F015E32B012	331,00 €
● F015E32B018	331,00 €
● F015E32B030	331,00 €
● F015E32B033	331,00 €

Dali

○ F015E32D000	331,00 €
○ F015E32D001	331,00 €
● F015E32D006	331,00 €
● F015E32D012	331,00 €
● F015E32D018	331,00 €
● F015E32D030	331,00 €
● F015E32D033	331,00 €

4000K

Non Dimmable

○ F015E42A000	272,00 €
○ F015E42A001	272,00 €
● F015E42A006	272,00 €
● F015E42A012	272,00 €
● F015E42A018	272,00 €
● F015E42A030	272,00 €
● F015E42A033	272,00 €
1-10V	
○ F015E42B000	331,00 €
○ F015E42B001	331,00 €
● F015E42B006	331,00 €
● F015E42B012	331,00 €
● F015E42B018	331,00 €
● F015E42B030	331,00 €
● F015E42B033	331,00 €

Dali

○ F015E42D000	331,00 €
○ F015E42D001	331,00 €
● F015E42D006	331,00 €
● F015E42D012	331,00 €
● F015E42D018	331,00 €
● F015E42D030	331,00 €
● F015E42D033	331,00 €

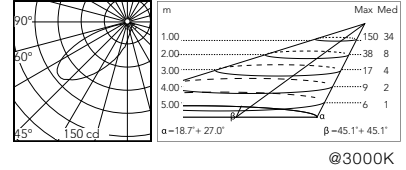

@3000K

Mile Wall 2 Asymmetric Up & Down

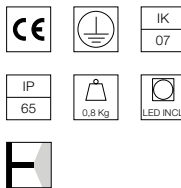
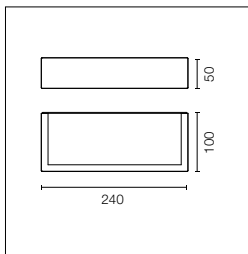

Source lumineuse LED incluse. Alimentation électrique 220-240V ON/OFF et dimmable 1-10V ou DALI intégrée. Equipé d'un double pressecâble pour connexion entrée-sortie.

LED light source included. Integrated 220-240V ON/OFF and 1-10V or DALI dimmable electrical power. Equipped with double cable gland for electrical connection.

2200K disponible sur demande.

2200K available on request.

Mid - Power Led: 13,5W - 2x838 lm ≠ FIXT 2x603 lm - 2700K/CRI 80 - 220-240V / 13,5W - 2x872 lm ≠ FIXT 2x627 lm - 3000K/CRI 80 - 220-240V / 13,5W - 2x905 lm ≠ FIXT 2x651 lm - 4000K/CRI 80 - 220-240V

2700K

Non Dimmable

○ F015D23A000	315,00 €
○ F015D23A001	315,00 €
● F015D23A006	315,00 €
● F015D23A012	315,00 €
● F015D23A018	315,00 €
● F015D23A030	315,00 €
● F015D23A033	315,00 €
1-10V	
○ F015D23B000	377,00 €
○ F015D23B001	377,00 €
● F015D23B006	377,00 €
● F015D23B012	377,00 €
● F015D23B018	377,00 €
● F015D23B030	377,00 €
● F015D23B033	377,00 €
Dali	
○ F015D23D000	377,00 €
○ F015D23D001	377,00 €
● F015D23D006	377,00 €
● F015D23D012	377,00 €
● F015D23D018	377,00 €
● F015D23D030	377,00 €
● F015D23D033	377,00 €

3000K

Non Dimmable

○ F015D33A000	315,00 €
○ F015D33A001	315,00 €
● F015D33A006	315,00 €
● F015D33A012	315,00 €
● F015D33A018	315,00 €
● F015D33A030	315,00 €
● F015D33A033	315,00 €
1-10V	
○ F015D33B000	377,00 €
○ F015D33B001	377,00 €
● F015D33B006	377,00 €
● F015D33B012	377,00 €
● F015D33B018	377,00 €
● F015D33B030	377,00 €
● F015D33B033	377,00 €
Dali	
○ F015D33D000	377,00 €
○ F015D33D001	377,00 €
● F015D33D006	377,00 €
● F015D33D012	377,00 €
● F015D33D018	377,00 €
● F015D33D030	377,00 €
● F015D33D033	377,00 €

4000K

Non Dimmable

○ F015D43A000	315,00 €
○ F015D43A001	315,00 €
● F015D43A006	315,00 €
● F015D43A012	315,00 €
● F015D43A018	315,00 €
● F015D43A030	315,00 €
● F015D43A033	315,00 €
1-10V	
○ F015D43B000	377,00 €
○ F015D43B001	377,00 €
● F015D43B006	377,00 €
● F015D43B012	377,00 €
● F015D43B018	377,00 €
● F015D43B030	377,00 €
● F015D43B033	377,00 €
Dali	
○ F015D43D000	377,00 €
○ F015D43D001	377,00 €
● F015D43D006	377,00 €
● F015D43D012	377,00 €
● F015D43D018	377,00 €
● F015D43D030	377,00 €
● F015D43D033	377,00 €

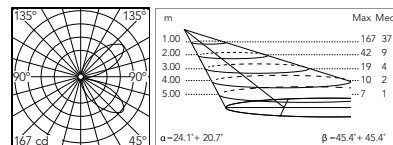

@3000K

Mile Wall 2 Washer Up & Down

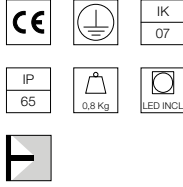
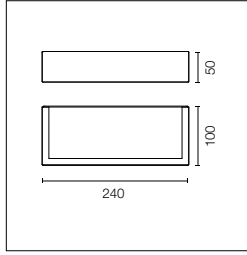

Source lumineuse LED incluse. Alimentation électrique 220-240V ON/OFF et dimmable 1-10V ou DALI intégrée. Equipé d'un double pressecâble pour connexion entrée-sortie.

LED light source included. Integrated 220-240V ON/OFF and 1-10V or DALI dimmable electrical power. Equipped with double cable gland for electrical connection.

2200K disponible sur demande.

2200K available on request.

Mid - Power Led: 10,5W - 2x661 lm ≠ FIXT 2x453 lm - 2700K/CRI 80 - 220-240V / 10,5W - 2x714 lm ≠ FIXT 2x471 lm - 3000K/CRI 80 - 220-240V / 10,5W - 2x714 lm ≠ FIXT 2x489 lm - 4000K/CRI 80 - 220-240V

2700K

Non Dimmable

○ F015E23A000	315,00 €
○ F015E23A001	315,00 €
● F015E23A006	315,00 €
● F015E23A012	315,00 €
● F015E23A018	315,00 €
● F015E23A030	315,00 €
● F015E23A033	315,00 €
1-10V	
○ F015E23B000	377,00 €
○ F015E23B001	377,00 €
● F015E23B006	377,00 €
● F015E23B012	377,00 €
● F015E23B018	377,00 €
● F015E23B030	377,00 €
● F015E23B033	377,00 €

Dali

○ F015E23D000	377,00 €
○ F015E23D001	377,00 €
● F015E23D006	377,00 €
● F015E23D012	377,00 €
● F015E23D018	377,00 €
● F015E23D030	377,00 €
● F015E23D033	377,00 €

3000K

Non Dimmable

○ F015E33A000	315,00 €
○ F015E33A001	315,00 €
● F015E33A006	315,00 €
● F015E33A012	315,00 €
● F015E33A018	315,00 €
● F015E33A030	315,00 €
● F015E33A033	315,00 €
1-10V	
○ F015E33B000	377,00 €
○ F015E33B001	377,00 €
● F015E33B006	377,00 €
● F015E33B012	377,00 €
● F015E33B018	377,00 €
● F015E33B030	377,00 €
● F015E33B033	377,00 €

Dali

○ F015E33D000	377,00 €
○ F015E33D001	377,00 €
● F015E33D006	377,00 €
● F015E33D012	377,00 €
● F015E33D018	377,00 €
● F015E33D030	377,00 €
● F015E33D033	377,00 €

4000K

Non Dimmable

○ F015E43A000	315,00 €
○ F015E43A001	315,00 €
● F015E43A006	315,00 €
● F015E43A012	315,00 €
● F015E43A018	315,00 €
● F015E43A030	315,00 €
● F015E43A033	315,00 €
1-10V	
○ F015E43B000	377,00 €
○ F015E43B001	377,00 €
● F015E43B006	377,00 €
● F015E43B012	377,00 €
● F015E43B018	377,00 €
● F015E43B030	377,00 €
● F015E43B033	377,00 €

Dali

○ F015E43D000	377,00 €
○ F015E43D001	377,00 €
● F015E43D006	377,00 €
● F015E43D012	377,00 €
● F015E43D018	377,00 €
● F015E43D030	377,00 €
● F015E43D033	377,00 €

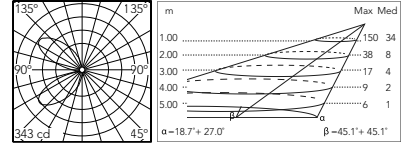

@3000K

Mile Wall 2 Washer Down + Asymmetric Up

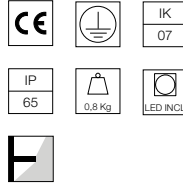
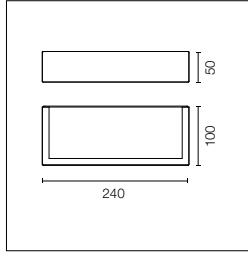

Source lumineuse LED incluse. Alimentation électrique 220-240V ON/OFF et dimmable 1-10V ou DALI intégrée. Equipé d'un double pressecâble pour connexion entrée-sortie.

LED light source included. Integrated 220-240V ON/OFF and 1-10V or DALI dimmable electrical power. Equipped with double cable gland for electrical connection.

2200K disponible sur demande.

2200K available on request.

Mid - Power Led: 12W - 661+838 lm ≠ FIXT 453+603 lm - 2700K/CRI 80 - 220-240V / 12W - 2714+872 lm ≠ FIXT 471+627 lm - 3000K/CRI 80 - 220-240V / 12W - 714+905 lm ≠ FIXT 489+651 lm - 4000K/CRI 80 - 220-240V

2700K

Non Dimmable

○ F015F24A000	315,00 €
○ F015F24A001	315,00 €
● F015F24A006	315,00 €
● F015F24A012	315,00 €
● F015F24A018	315,00 €
● F015F24A030	315,00 €
● F015F24A033	315,00 €
1-10V	
○ F015F24B000	377,00 €
○ F015F24B001	377,00 €
● F015F24B006	377,00 €
● F015F24B012	377,00 €
● F015F24B018	377,00 €
● F015F24B030	377,00 €
● F015F24B033	377,00 €
Dali	
○ F015F24D000	377,00 €
○ F015F24D001	377,00 €
● F015F24D006	377,00 €
● F015F24D012	377,00 €
● F015F24D018	377,00 €
● F015F24D030	377,00 €
● F015F24D033	377,00 €

3000K

Non Dimmable

○ F015F34A000	315,00 €
○ F015F34A001	315,00 €
● F015F34A006	315,00 €
● F015F34A012	315,00 €
● F015F34A018	315,00 €
● F015F34A030	315,00 €
● F015F34A033	315,00 €
1-10V	
○ F015F34B000	377,00 €
○ F015F34B001	377,00 €
● F015F34B006	377,00 €
● F015F34B012	377,00 €
● F015F34B018	377,00 €
● F015F34B030	377,00 €
● F015F34B033	377,00 €
Dali	
○ F015F34D000	377,00 €
○ F015F34D001	377,00 €
● F015F34D006	377,00 €
● F015F34D012	377,00 €
● F015F34D018	377,00 €
● F015F34D030	377,00 €
● F015F34D033	377,00 €

4000K

Non Dimmable

○ F015F44A000	315,00 €
○ F015F44A001	315,00 €
● F015F44A006	315,00 €
● F015F44A012	315,00 €
● F015F44A018	315,00 €
● F015F44A030	315,00 €
● F015F44A033	315,00 €
1-10V	
○ F015F44B000	377,00 €
○ F015F44B001	377,00 €
● F015F44B006	377,00 €
● F015F44B012	377,00 €
● F015F44B018	377,00 €
● F015F44B030	377,00 €
● F015F44B033	377,00 €
Dali	
○ F015F44D000	377,00 €
○ F015F44D001	377,00 €
● F015F44D006	377,00 €
● F015F44D012	377,00 €
● F015F44D018	377,00 €
● F015F44D030	377,00 €
● F015F44D033	377,00 €

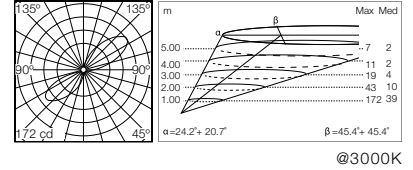

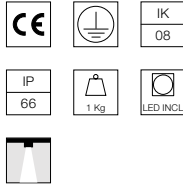
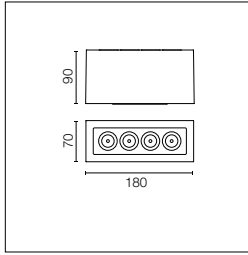

Source de lumière LED incluse.
Alimentation électrique intégrée
220-240V ON/OFF ou réglable
1-10V / DALI.
Équipé de doubles passe-fils
pour la connexion d'entrée et
de sortie. Support de fixation
inclus.

LED light source included.
Integrated 220-240V ON/OFF
and 1-10V/DALI dimmable
electrical power.
Equipped with double cable
gland for inlet and outlet
connection. Fixing bracket
included.

2200K disponible sur demande.

2200K available on request.

Power Led: 11W - 994 lm ≠ *FIXT 736 lm - 2700K/CRI>80 - 220-240V / 11W - 1030 lm ≠ *FIXT 759 lm - 3000K/CRI>80 - 220-240V /
11W - 1067 lm ≠ *FIXT 791 lm - 4000K/CRI>80 - 220-240V
*Fixt lm = Spot Optic

Optic Spot

2700K

Non Dimmable

- F030A21A000 397,00 €
- F030A21A001 397,00 €
- F030A21A006 397,00 €
- F030A21A012 397,00 €
- F030A21A018 397,00 €
- F030A21A030 397,00 €
- F030A21A033 397,00 €

1-10V

- F030A21B000 493,00 €
- F030A21B001 493,00 €
- F030A21B006 493,00 €
- F030A21B012 493,00 €
- F030A21B018 493,00 €
- F030A21B030 493,00 €
- F030A21B033 493,00 €

Dali

- F030A21D000 493,00 €
- F030A21D001 493,00 €
- F030A21D006 493,00 €
- F030A21D012 493,00 €
- F030A21D018 493,00 €
- F030A21D030 493,00 €
- F030A21D033 493,00 €

3000K

Non Dimmable

- F030A31A000 397,00 €
- F030A31A001 397,00 €
- F030A31A006 397,00 €
- F030A31A012 397,00 €
- F030A31A018 397,00 €
- F030A31A030 397,00 €
- F030A31A033 397,00 €

1-10V

- F030A31B000 493,00 €
- F030A31B001 493,00 €
- F030A31B006 493,00 €
- F030A31B012 493,00 €
- F030A31B018 493,00 €
- F030A31B030 493,00 €
- F030A31B033 493,00 €

Dali

- F030A31D000 493,00 €
- F030A31D001 493,00 €
- F030A31D006 493,00 €
- F030A31D012 493,00 €
- F030A31D018 493,00 €
- F030A31D030 493,00 €
- F030A31D033 493,00 €

4000K

Non Dimmable

- F030A41A000 397,00 €
- F030A41A001 397,00 €
- F030A41A006 397,00 €
- F030A41A012 397,00 €
- F030A41A018 397,00 €
- F030A41A030 397,00 €
- F030A41A033 397,00 €

1-10V

- F030A41B000 493,00 €
- F030A41B001 493,00 €
- F030A41B006 493,00 €
- F030A41B012 493,00 €
- F030A41B018 493,00 €
- F030A41B030 493,00 €
- F030A41B033 493,00 €

Dali

- F030A41D000 493,00 €
- F030A41D001 493,00 €
- F030A41D006 493,00 €
- F030A41D012 493,00 €
- F030A41D018 493,00 €
- F030A41D030 493,00 €
- F030A41D033 493,00 €

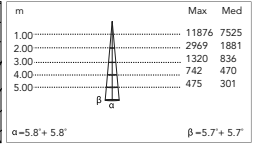
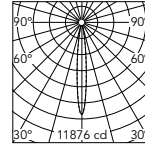

@3000K

Optic Medium

2700K

Non Dimmable

- F030A22A000 397,00 €
- F030A22A001 397,00 €
- F030A22A006 397,00 €
- F030A22A012 397,00 €
- F030A22A018 397,00 €
- F030A22A030 397,00 €
- F030A22A033 397,00 €

1-10V

- F030A22B000 493,00 €
- F030A22B001 493,00 €
- F030A22B006 493,00 €
- F030A22B012 493,00 €
- F030A22B018 493,00 €
- F030A22B030 493,00 €
- F030A22B033 493,00 €

Dali

- F030A22D000 493,00 €
- F030A22D001 493,00 €
- F030A22D006 493,00 €
- F030A22D012 493,00 €
- F030A22D018 493,00 €
- F030A22D030 493,00 €
- F030A22D033 493,00 €

3000K

Non Dimmable

- F030A32A000 397,00 €
- F030A32A001 397,00 €
- F030A32A006 397,00 €
- F030A32A012 397,00 €
- F030A32A018 397,00 €
- F030A32A030 397,00 €
- F030A32A033 397,00 €

1-10V

- F030A32B000 493,00 €
- F030A32B001 493,00 €
- F030A32B006 493,00 €
- F030A32B012 493,00 €
- F030A32B018 493,00 €
- F030A32B030 493,00 €
- F030A32B033 493,00 €

Dali

- F030A32D000 493,00 €
- F030A32D001 493,00 €
- F030A32D006 493,00 €
- F030A32D012 493,00 €
- F030A32D018 493,00 €
- F030A32D030 493,00 €
- F030A32D033 493,00 €

4000K

Non Dimmable

- F030A42A000 397,00 €
- F030A42A001 397,00 €
- F030A42A006 397,00 €
- F030A42A012 397,00 €
- F030A42A018 397,00 €
- F030A42A030 397,00 €
- F030A42A033 397,00 €

1-10V

- F030A42B000 493,00 €
- F030A42B001 493,00 €
- F030A42B006 493,00 €
- F030A42B012 493,00 €
- F030A42B018 493,00 €
- F030A42B030 493,00 €
- F030A42B033 493,00 €

Dali

- F030A42D000 493,00 €
- F030A42D001 493,00 €
- F030A42D006 493,00 €
- F030A42D012 493,00 €
- F030A42D018 493,00 €
- F030A42D030 493,00 €
- F030A42D033 493,00 €

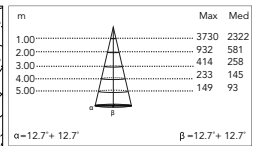
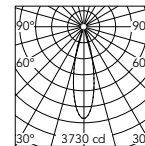

@3000K

Optic Flood

2700K

Non Dimmable

○ F030A23A000	397,00 €
○ F030A23A001	397,00 €
● F030A23A006	397,00 €
● F030A23A012	397,00 €
● F030A23A018	397,00 €
● F030A23A030	397,00 €
● F030A23A033	397,00 €
1-10V	
○ F030A23B000	493,00 €
○ F030A23B001	493,00 €
● F030A23B006	493,00 €
● F030A23B012	493,00 €
● F030A23B018	493,00 €
● F030A23B030	493,00 €
● F030A23B033	493,00 €
Dali	
○ F030A23D000	493,00 €
○ F030A23D001	493,00 €
● F030A23D006	493,00 €
● F030A23D012	493,00 €
● F030A23D018	493,00 €
● F030A23D030	493,00 €
● F030A23D033	493,00 €

3000K

Non Dimmable

○ F030A33A000	397,00 €
○ F030A33A001	397,00 €
● F030A33A006	397,00 €
● F030A33A012	397,00 €
● F030A33A018	397,00 €
● F030A33A030	397,00 €
● F030A33A033	397,00 €
1-10V	
○ F030A33B000	493,00 €
○ F030A33B001	493,00 €
● F030A33B006	493,00 €
● F030A33B012	493,00 €
● F030A33B018	493,00 €
● F030A33B030	493,00 €
● F030A33B033	493,00 €
Dali	
○ F030A33D000	493,00 €
○ F030A33D001	493,00 €
● F030A33D006	493,00 €
● F030A33D012	493,00 €
● F030A33D018	493,00 €
● F030A33D030	493,00 €
● F030A33D033	493,00 €

4000K

Non Dimmable

○ F030A43A000	397,00 €
○ F030A43A001	397,00 €
● F030A43A006	397,00 €
● F030A43A012	397,00 €
● F030A43A018	397,00 €
● F030A43A030	397,00 €
● F030A43A033	397,00 €
1-10V	
○ F030A43B000	493,00 €
○ F030A43B001	493,00 €
● F030A43B006	493,00 €
● F030A43B012	493,00 €
● F030A43B018	493,00 €
● F030A43B030	493,00 €
● F030A43B033	493,00 €
Dali	
○ F030A43D000	493,00 €
○ F030A43D001	493,00 €
● F030A43D006	493,00 €
● F030A43D012	493,00 €
● F030A43D018	493,00 €
● F030A43D030	493,00 €
● F030A43D033	493,00 €

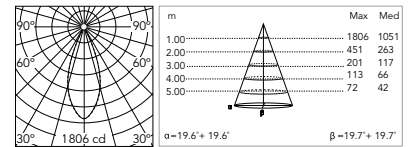

Accessoires pour les versions non dimmables / Accessories for non-dimmable versions

Système de jonction IP68 H2O Stop anti-condensation à 2 voies 4 pôles.	2 way terminal block 4 poles IP68 H2O Stop.	F990C00A000	33,00 €		
Système de jonction IP68 H2O Stop anti-condensation à 3/4 voies 4 pôles. (Ø5,5÷12mm câble).	3/4 way terminal block 4 poles IP68 H2O Stop. (Ø5,5÷12mm cable).	F990C010000	60,00 €		

Accessoires pour les versions dimmables / Accessories for dimmable versions

Kit de connecteurs à 5 pôles: fiche volante + fiche EU IP68.	Connector kit 5-pole flying socket + EU plug IP68.	F990C080000	48,00 €		
Boitier de dérivation 5 pôles 4 voies (câbles 6-14 mm).	4 way junction box 5 poles IP68 (6-14 mm cables).	F990C030000	62,00 €		

Mile Ceiling 2

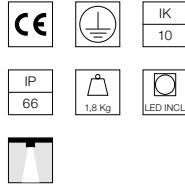
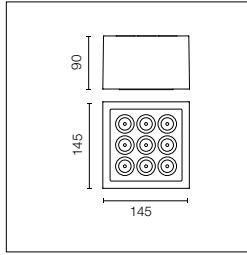

Source de lumière LED incluse.
Alimentation électrique intégrée
220-240V ON/OFF ou réglable
1-10V / DALI.
Équipé de doubles passe-fils
pour la connexion d'entrée et
de sortie. Support de fixation
inclus.

LED light source included.
Integrated 220-240V ON/OFF
and 1-10V/DALI dimmable
electrical power.
Equipped with double cable
gland for inlet and outlet
connection. Fixing bracket
included.

2200K disponible sur demande.

2200K available on request.

Power Led: 15W - 1677 lm ≠ *FIXT 1032 lm - 2700K/CRI>80 - 220-240V / 15W - 1739 lm ≠ *FIXT 1344 lm - 3000K/CRI>80 - 220-240V /
15W - 1800 lm ≠ *FIXT 1400 lm - 4000K/CRI>80 - 220-240V
*Fixt lm = Spot Optic

Optic Spot

2700K

Non Dimmable

○ F030C21A000	541,00 €
○ F030C21A001	541,00 €
● F030C21A006	541,00 €
● F030C21A012	541,00 €
● F030C21A018	541,00 €
● F030C21A030	541,00 €
● F030C21A033	541,00 €
1-10V	
○ F030C21B000	633,00 €
○ F030C21B001	633,00 €
● F030C21B006	633,00 €
● F030C21B012	633,00 €
● F030C21B018	633,00 €
● F030C21B030	633,00 €
● F030C21B033	633,00 €

Dali

○ F030C21D000	633,00 €
○ F030C21D001	633,00 €
● F030C21D006	633,00 €
● F030C21D012	633,00 €
● F030C21D018	633,00 €
● F030C21D030	633,00 €
● F030C21D033	633,00 €

3000K

Non Dimmable

○ F030C31A000	541,00 €
○ F030C31A001	541,00 €
● F030C31A006	541,00 €
● F030C31A012	541,00 €
● F030C31A018	541,00 €
● F030C31A030	541,00 €
● F030C31A033	541,00 €
1-10V	
○ F030C31B000	633,00 €
○ F030C31B001	633,00 €
● F030C31B006	633,00 €
● F030C31B012	633,00 €
● F030C31B018	633,00 €
● F030C31B030	633,00 €
● F030C31B033	633,00 €

Dali

○ F030C31D000	633,00 €
○ F030C31D001	633,00 €
● F030C31D006	633,00 €
● F030C31D012	633,00 €
● F030C31D018	633,00 €
● F030C31D030	633,00 €
● F030C31D033	633,00 €

4000K

Non Dimmable

○ F030C41A000	541,00 €
○ F030C41A001	541,00 €
● F030C41A006	541,00 €
● F030C41A012	541,00 €
● F030C41A018	541,00 €
● F030C41A030	541,00 €
● F030C41A033	541,00 €
1-10V	
○ F030C41B000	633,00 €
○ F030C41B001	633,00 €
● F030C41B006	633,00 €
● F030C41B012	633,00 €
● F030C41B018	633,00 €
● F030C41B030	633,00 €
● F030C41B033	633,00 €

Dali

○ F030C41D000	633,00 €
○ F030C41D001	633,00 €
● F030C41D006	633,00 €
● F030C41D012	633,00 €
● F030C41D018	633,00 €
● F030C41D030	633,00 €
● F030C41D033	633,00 €

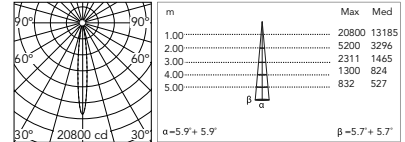

@3000K

Optic Medium

2700K

Non Dimmable

○ F030C22A000	541,00 €
○ F030C22A001	541,00 €
● F030C22A006	541,00 €
● F030C22A012	541,00 €
● F030C22A018	541,00 €
● F030C22A030	541,00 €
● F030C22A033	541,00 €
1-10V	
○ F030C22B000	633,00 €
○ F030C22B001	633,00 €
● F030C22B006	633,00 €
● F030C22B012	633,00 €
● F030C22B018	633,00 €
● F030C22B030	633,00 €
● F030C22B033	633,00 €

Dali

○ F030C22D000	633,00 €
○ F030C22D001	633,00 €
● F030C22D006	633,00 €
● F030C22D012	633,00 €
● F030C22D018	633,00 €
● F030C22D030	633,00 €
● F030C22D033	633,00 €

3000K

Non Dimmable

○ F030C32A000	541,00 €
○ F030C32A001	541,00 €
● F030C32A006	541,00 €
● F030C32A012	541,00 €
● F030C32A018	541,00 €
● F030C32A030	541,00 €
● F030C32A033	541,00 €
1-10V	
○ F030C32B000	633,00 €
○ F030C32B001	633,00 €
● F030C32B006	633,00 €
● F030C32B012	633,00 €
● F030C32B018	633,00 €
● F030C32B030	633,00 €
● F030C32B033	633,00 €

Dali

○ F030C32D000	633,00 €
○ F030C32D001	633,00 €
● F030C32D006	633,00 €
● F030C32D012	633,00 €
● F030C32D018	633,00 €
● F030C32D030	633,00 €
● F030C32D033	633,00 €

4000K

Non Dimmable

○ F030C42A000	541,00 €
○ F030C42A001	541,00 €
● F030C42A006	541,00 €
● F030C42A012	541,00 €
● F030C42A018	541,00 €
● F030C42A030	541,00 €
● F030C42A033	541,00 €
1-10V	
○ F030C42B000	633,00 €
○ F030C42B001	633,00 €
● F030C42B006	633,00 €
● F030C42B012	633,00 €
● F030C42B018	633,00 €
● F030C42B030	633,00 €
● F030C42B033	633,00 €

Dali

○ F030C42D000	633,00 €
○ F030C42D001	633,00 €
● F030C42D006	633,00 €
● F030C42D012	633,00 €
● F030C42D018	633,00 €
● F030C42D030	633,00 €
● F030C42D033	633,00 €

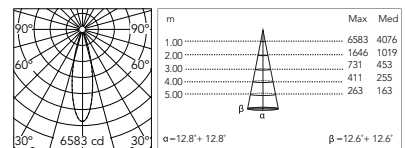

@3000K

Optic Flood

2700K

Non Dimmable

○ F030C23A000	541,00 €
○ F030C23A001	541,00 €
● F030C23A006	541,00 €
● F030C23A012	541,00 €
● F030C23A018	541,00 €
● F030C23A030	541,00 €
● F030C23A033	541,00 €
1-10V	
○ F030C23B000	633,00 €
○ F030C23B001	633,00 €
● F030C23B006	633,00 €
● F030C23B012	633,00 €
● F030C23B018	633,00 €
● F030C23B030	633,00 €
● F030C23B033	633,00 €
Dali	
○ F030C23D000	633,00 €
○ F030C23D001	633,00 €
● F030C23D006	633,00 €
● F030C23D012	633,00 €
● F030C23D018	633,00 €
● F030C23D030	633,00 €
● F030C23D033	633,00 €

3000K

Non Dimmable

○ F030C33A000	541,00 €
○ F030C33A001	541,00 €
● F030C33A006	541,00 €
● F030C33A012	541,00 €
● F030C33A018	541,00 €
● F030C33A030	541,00 €
● F030C33A033	541,00 €
1-10V	
○ F030C33B000	633,00 €
○ F030C33B001	633,00 €
● F030C33B006	633,00 €
● F030C33B012	633,00 €
● F030C33B018	633,00 €
● F030C33B030	633,00 €
● F030C33B033	633,00 €
Dali	
○ F030C33D000	633,00 €
○ F030C33D001	633,00 €
● F030C33D006	633,00 €
● F030C33D012	633,00 €
● F030C33D018	633,00 €
● F030C33D030	633,00 €
● F030C33D033	633,00 €

4000K

Non Dimmable

○ F030C43A000	541,00 €
○ F030C43A001	541,00 €
● F030C43A006	541,00 €
● F030C43A012	541,00 €
● F030C43A018	541,00 €
● F030C43A030	541,00 €
● F030C43A033	541,00 €
1-10V	
○ F030C43B000	633,00 €
○ F030C43B001	633,00 €
● F030C43B006	633,00 €
● F030C43B012	633,00 €
● F030C43B018	633,00 €
● F030C43B030	633,00 €
● F030C43B033	633,00 €
Dali	
○ F030C43D000	633,00 €
○ F030C43D001	633,00 €
● F030C43D006	633,00 €
● F030C43D012	633,00 €
● F030C43D018	633,00 €
● F030C43D030	633,00 €
● F030C43D033	633,00 €

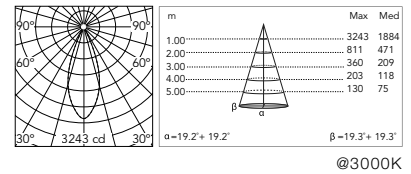

Accessoires pour les versions non dimmables / Accessories for non-dimmable versions

Système de jonction IP68 H2O Stop anti-condensation à 2 voies 4 pôles.	2 way terminal block 4 poles IP68 H2O Stop.	F990C00A000	33,00 €		
Système de jonction IP68 H2O Stop anti-condensation à 3/4 voies 4 pôles. (Ø5,5÷12mm câble).	3/4 way terminal block 4 poles IP68 H2O Stop. (ø5,5÷12mm cable).	F990C010000	60,00 €		

Accessoires pour les versions dimmables / Accessories for dimmable versions

Kit de connecteurs à 5 pôles: fiche volante + fiche EU IP68.	Connector kit 5-pole flying socket + EU plug IP68.	F990C080000	48,00 €		
Boîtier de dérivation 5 pôles 4 voies (câbles 6-14 mm).	4 way junction box 5 poles IP68 (6-14 mm cables).	F990C030000	62,00 €		

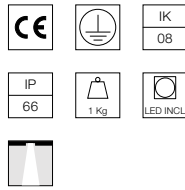
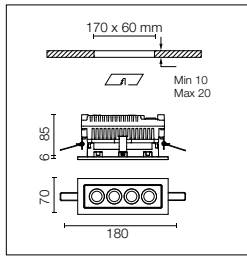

Source de lumière LED incluse.
Alimentation électrique intégrée
220-240V ON/OFF ou réglable
1-10V / DALI. Équipé d'une sortie
de câble en néoprène et d'un
double passe-câble pour la
connexion entrée/sortie.
Ressorts de fixation au plafond
inclus. Coffrage pour plafond
en brique à commander
séparément.

LED light source included.
Integrated 220-240V ON/OFF
and 1-10V/DALI dimmable
electrical power.
Equipped with neoprene
cable outlet and double cable
grommet for in/out connection.
Ceiling mounting springs
included. Box for brick roofing
installation to be ordered
separately.

2200K disponible sur demande.

2200K available on request.

Power Led: 11W - 994 lm ≠ *FIXT 736 lm - 2700K/CRI>80 - 220-240V / 11W - 1030 lm ≠ *FIXT 759 lm - 3000K/CRI>80 - 220-240V /
11W - 1067 lm ≠ *FIXT 791 lm - 4000K/CRI>80 - 220-240V
*Fixt lm = Spot Optic

Optic Spot

2700K

Non Dimmable

- F030B21A000 401,00 €
- F030B21A001 401,00 €
- F030B21A006 401,00 €
- F030B21A012 401,00 €
- F030B21A018 401,00 €
- F030B21A030 401,00 €
- F030B21A033 401,00 €
- 1-10V
- F030B21B000 500,00 €
- F030B21B001 500,00 €
- F030B21B006 500,00 €
- F030B21B012 500,00 €
- F030B21B018 500,00 €
- F030B21B030 500,00 €
- F030B21B033 500,00 €
- Dali
- F030B21D000 500,00 €
- F030B21D001 500,00 €
- F030B21D006 500,00 €
- F030B21D012 500,00 €
- F030B21D018 500,00 €
- F030B21D030 500,00 €
- F030B21D033 500,00 €

3000K

Non Dimmable

- F030B31A000 401,00 €
- F030B31A001 401,00 €
- F030B31A006 401,00 €
- F030B31A012 401,00 €
- F030B31A018 401,00 €
- F030B31A030 401,00 €
- F030B31A033 401,00 €
- 1-10V
- F030B31B000 500,00 €
- F030B31B001 500,00 €
- F030B31B006 500,00 €
- F030B31B012 500,00 €
- F030B31B018 500,00 €
- F030B31B030 500,00 €
- F030B31B033 500,00 €
- Dali
- F030B31D000 500,00 €
- F030B31D001 500,00 €
- F030B31D006 500,00 €
- F030B31D012 500,00 €
- F030B31D018 500,00 €
- F030B31D030 500,00 €
- F030B31D033 500,00 €

4000K

Non Dimmable

- F030B41A000 401,00 €
- F030B41A001 401,00 €
- F030B41A006 401,00 €
- F030B41A012 401,00 €
- F030B41A018 401,00 €
- F030B41A030 401,00 €
- F030B41A033 401,00 €
- 1-10V
- F030B41B000 500,00 €
- F030B41B001 500,00 €
- F030B41B006 500,00 €
- F030B41B012 500,00 €
- F030B41B018 500,00 €
- F030B41B030 500,00 €
- F030B41B033 500,00 €
- Dali
- F030B41D000 500,00 €
- F030B41D001 500,00 €
- F030B41D006 500,00 €
- F030B41D012 500,00 €
- F030B41D018 500,00 €
- F030B41D030 500,00 €
- F030B41D033 500,00 €

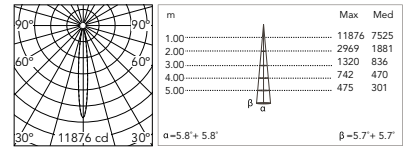

@3000K

Optic Medium

2700K

Non Dimmable

- F030B22A000 401,00 €
- F030B22A001 401,00 €
- F030B22A006 401,00 €
- F030B22A012 401,00 €
- F030B22A018 401,00 €
- F030B22A030 401,00 €
- F030B22A033 401,00 €
- 1-10V
- F030B22B000 500,00 €
- F030B22B001 500,00 €
- F030B22B006 500,00 €
- F030B22B012 500,00 €
- F030B22B018 500,00 €
- F030B22B030 500,00 €
- F030B22B033 500,00 €
- Dali
- F030B22D000 500,00 €
- F030B22D001 500,00 €
- F030B22D006 500,00 €
- F030B22D012 500,00 €
- F030B22D018 500,00 €
- F030B22D030 500,00 €
- F030B22D033 500,00 €

3000K

Non Dimmable

- F030B32A000 401,00 €
- F030B32A001 401,00 €
- F030B32A006 401,00 €
- F030B32A012 401,00 €
- F030B32A018 401,00 €
- F030B32A030 401,00 €
- F030B32A033 401,00 €
- 1-10V
- F030B32B000 500,00 €
- F030B32B001 500,00 €
- F030B32B006 500,00 €
- F030B32B012 500,00 €
- F030B32B018 500,00 €
- F030B32B030 500,00 €
- F030B32B033 500,00 €
- Dali
- F030B32D000 500,00 €
- F030B32D001 500,00 €
- F030B32D006 500,00 €
- F030B32D012 500,00 €
- F030B32D018 500,00 €
- F030B32D030 500,00 €
- F030B32D033 500,00 €

4000K

Non Dimmable

- F030B42A000 401,00 €
- F030B42A001 401,00 €
- F030B42A006 401,00 €
- F030B42A012 401,00 €
- F030B42A018 401,00 €
- F030B42A030 401,00 €
- F030B42A033 401,00 €
- 1-10V
- F030B42B000 500,00 €
- F030B42B001 500,00 €
- F030B42B006 500,00 €
- F030B42B012 500,00 €
- F030B42B018 500,00 €
- F030B42B030 500,00 €
- F030B42B033 500,00 €
- Dali
- F030B42D000 500,00 €
- F030B42D001 500,00 €
- F030B42D006 500,00 €
- F030B42D012 500,00 €
- F030B42D018 500,00 €
- F030B42D030 500,00 €
- F030B42D033 500,00 €

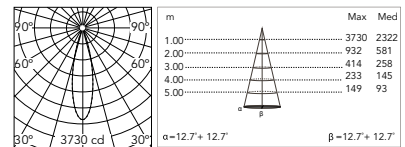

@3000K

Optic Flood

2700K

Non Dimmable

○ F030B23A000	401,00 €
○ F030B23A001	401,00 €
● F030B23A006	401,00 €
● F030B23A012	401,00 €
● F030B23A018	401,00 €
● F030B23A030	401,00 €
● F030B23A033	401,00 €
1-10V	
○ F030B23B000	500,00 €
○ F030B23B001	500,00 €
● F030B23B006	500,00 €
● F030B23B012	500,00 €
● F030B23B018	500,00 €
● F030B23B030	500,00 €
● F030B23B033	500,00 €
Dali	
○ F030B23D000	500,00 €
○ F030B23D001	500,00 €
● F030B23D006	500,00 €
● F030B23D012	500,00 €
● F030B23D018	500,00 €
● F030B23D030	500,00 €
● F030B23D033	500,00 €

3000K

Non Dimmable

○ F030B33A000	401,00 €
○ F030B33A001	401,00 €
● F030B33A006	401,00 €
● F030B33A012	401,00 €
● F030B33A018	401,00 €
● F030B33A030	401,00 €
● F030B33A033	401,00 €
1-10V	
○ F030B33B000	500,00 €
○ F030B33B001	500,00 €
● F030B33B006	500,00 €
● F030B33B012	500,00 €
● F030B33B018	500,00 €
● F030B33B030	500,00 €
● F030B33B033	500,00 €
Dali	
○ F030B33D000	500,00 €
○ F030B33D001	500,00 €
● F030B33D006	500,00 €
● F030B33D012	500,00 €
● F030B33D018	500,00 €
● F030B33D030	500,00 €
● F030B33D033	500,00 €

4000K

Non Dimmable

○ F030B43A000	401,00 €
○ F030B43A001	401,00 €
● F030B43A006	401,00 €
● F030B43A012	401,00 €
● F030B43A018	401,00 €
● F030B43A030	401,00 €
● F030B43A033	401,00 €
1-10V	
○ F030B43B000	500,00 €
○ F030B43B001	500,00 €
● F030B43B006	500,00 €
● F030B43B012	500,00 €
● F030B43B018	500,00 €
● F030B43B030	500,00 €
● F030B43B033	500,00 €
Dali	
○ F030B43D000	500,00 €
○ F030B43D001	500,00 €
● F030B43D006	500,00 €
● F030B43D012	500,00 €
● F030B43D018	500,00 €
● F030B43D030	500,00 €
● F030B43D033	500,00 €

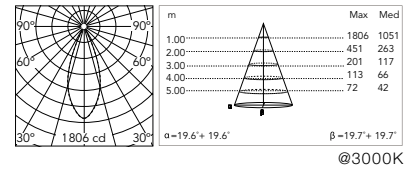

@3000K

Mile Recessed 1: Accessoires / Accessories

Boîte en métal pour installation sur des plafonds en ciment.

Metal installation box for concrete ceiling.

F030Z010000

99,00 €

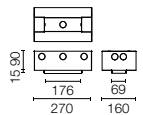

Accessoires pour les versions non dimmables / Accessories for non-dimmable versions

Système de jonction IP68 H2O Stop anti-condensation à 2 voies 4 pôles.

2 way terminal block 4 poles IP68 H2O Stop.

F990C00A000

33,00 €



Système de jonction IP68 H2O Stop anti-condensation à 3/4 voies 4 pôles. (Ø5,5÷12mm câble).

3/4 way terminal block 4 poles IP68 H2O Stop. (ø5,5÷12mm cable).

F990C010000

60,00 €



Accessoires pour les versions dimmables / Accessories for dimmable versions

Kit de connecteurs à 5 pôles: fiche volante + fiche EU IP68.

Connector kit 5-pole flying socket + EU plug IP68.

F990C080000

48,00 €



Boitier de dérivation 5 pôles 4 voies (câbles 6-14 mm).

4 way junction box 5 poles IP68 (6-14 mm cables).

F990C030000

62,00 €



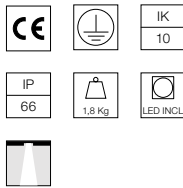
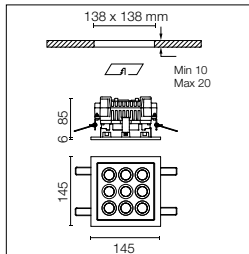

Source de lumière LED incluse.
Alimentation électrique intégrée
220-240V ON/OFF ou réglable
1-10V / DALI. Équipé d'une sortie
de câble en néoprène et d'un
double passe-câble pour la
connexion entrée/sortie.
Ressorts de fixation au plafond
inclus. Coffrage pour plafond
en brique à commander
séparément.

LED light source included.
Integrated 220-240V ON/OFF
and 1-10V/DALI dimmable
electrical power.
Equipped with neoprene
cable outlet and double cable
grommet for in/out connection.
Ceiling mounting springs
included. Box for brick roofing
installation to be ordered
separately.

2200K disponible sur demande.

2200K available on request.

Power Led: 15W - 1677 lm ≠ *FIXT 1032 lm - 2700K/CRI>80 - 220-240V / 15W - 1739 lm ≠ *FIXT 1344 lm - 3000K/CRI>80 - 220-240V /
15W - 1800 lm ≠ *FIXT 1400 lm - 4000K/CRI>80 - 220-240V
*Fixt lm = Spot Optic

Optic Spot

2700K

Non Dimmable

- F030D21A000 530,00 €
- F030D21A001 530,00 €
- F030D21A006 530,00 €
- F030D21A012 530,00 €
- F030D21A018 530,00 €
- F030D21A030 530,00 €
- F030D21A033 530,00 €
- 1-10V
- F030D21B000 622,00 €
- F030D21B001 622,00 €
- F030D21B006 622,00 €
- F030D21B012 622,00 €
- F030D21B018 622,00 €
- F030D21B030 622,00 €
- F030D21B033 622,00 €
- Dali
- F030D21D000 622,00 €
- F030D21D001 622,00 €
- F030D21D006 622,00 €
- F030D21D012 622,00 €
- F030D21D018 622,00 €
- F030D21D030 622,00 €
- F030D21D033 622,00 €

3000K

Non Dimmable

- F030D31A000 530,00 €
- F030D31A001 530,00 €
- F030D31A006 530,00 €
- F030D31A012 530,00 €
- F030D31A018 530,00 €
- F030D31A030 530,00 €
- F030D31A033 530,00 €
- 1-10V
- F030D31B000 622,00 €
- F030D31B001 622,00 €
- F030D31B006 622,00 €
- F030D31B012 622,00 €
- F030D31B018 622,00 €
- F030D31B030 622,00 €
- F030D31B033 622,00 €
- Dali
- F030D31D000 622,00 €
- F030D31D001 622,00 €
- F030D31D006 622,00 €
- F030D31D012 622,00 €
- F030D31D018 622,00 €
- F030D31D030 622,00 €
- F030D31D033 622,00 €

4000K

Non Dimmable

- F030D41A000 530,00 €
- F030D41A001 530,00 €
- F030D41A006 530,00 €
- F030D41A012 530,00 €
- F030D41A018 530,00 €
- F030D41A030 530,00 €
- F030D41A033 530,00 €
- 1-10V
- F030D41B000 622,00 €
- F030D41B001 622,00 €
- F030D41B006 622,00 €
- F030D41B012 622,00 €
- F030D41B018 622,00 €
- F030D41B030 622,00 €
- F030D41B033 622,00 €
- Dali
- F030D41D000 622,00 €
- F030D41D001 622,00 €
- F030D41D006 622,00 €
- F030D41D012 622,00 €
- F030D41D018 622,00 €
- F030D41D030 622,00 €
- F030D41D033 622,00 €

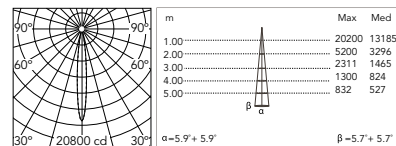

@3000K

Optic Medium

2700K

Non Dimmable

- F030D22A000 530,00 €
- F030D22A001 530,00 €
- F030D22A006 530,00 €
- F030D22A012 530,00 €
- F030D22A018 530,00 €
- F030D22A030 530,00 €
- F030D22A033 530,00 €
- 1-10V
- F030D22B000 622,00 €
- F030D22B001 622,00 €
- F030D22B006 622,00 €
- F030D22B012 622,00 €
- F030D22B018 622,00 €
- F030D22B030 622,00 €
- F030D22B033 622,00 €
- Dali
- F030D22D000 622,00 €
- F030D22D001 622,00 €
- F030D22D006 622,00 €
- F030D22D012 622,00 €
- F030D22D018 622,00 €
- F030D22D030 622,00 €
- F030D22D033 622,00 €

3000K

Non Dimmable

- F030D32A000 530,00 €
- F030D32A001 530,00 €
- F030D32A006 530,00 €
- F030D32A012 530,00 €
- F030D32A018 530,00 €
- F030D32A030 530,00 €
- F030D32A033 530,00 €
- 1-10V
- F030D32B000 622,00 €
- F030D32B001 622,00 €
- F030D32B006 622,00 €
- F030D32B012 622,00 €
- F030D32B018 622,00 €
- F030D32B030 622,00 €
- F030D32B033 622,00 €
- Dali
- F030D32D000 622,00 €
- F030D32D001 622,00 €
- F030D32D006 622,00 €
- F030D32D012 622,00 €
- F030D32D018 622,00 €
- F030D32D030 622,00 €
- F030D32D033 622,00 €

4000K

Non Dimmable

- F030D42A000 530,00 €
- F030D42A001 530,00 €
- F030D42A006 530,00 €
- F030D42A012 530,00 €
- F030D42A018 530,00 €
- F030D42A030 530,00 €
- F030D42A033 530,00 €
- 1-10V
- F030D42B000 622,00 €
- F030D42B001 622,00 €
- F030D42B006 622,00 €
- F030D42B012 622,00 €
- F030D42B018 622,00 €
- F030D42B030 622,00 €
- F030D42B033 622,00 €
- Dali
- F030D42D000 622,00 €
- F030D42D001 622,00 €
- F030D42D006 622,00 €
- F030D42D012 622,00 €
- F030D42D018 622,00 €
- F030D42D030 622,00 €
- F030D42D033 622,00 €

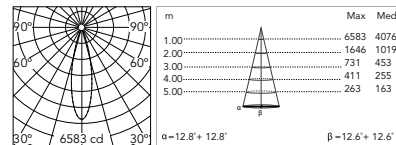

@3000K

Optic Flood

2700K

Non Dimmable

○ F030D23A000	530,00 €
○ F030D23A001	530,00 €
● F030D23A006	530,00 €
● F030D23A012	530,00 €
● F030D23A018	530,00 €
● F030D23A030	530,00 €
● F030D23A033	530,00 €
1-10V	
○ F030D23B000	622,00 €
○ F030D23B001	622,00 €
● F030D23B006	622,00 €
● F030D23B012	622,00 €
● F030D23B018	622,00 €
● F030D23B030	622,00 €
● F030D23B033	622,00 €
Dali	
○ F030D23D000	622,00 €
○ F030D23D001	622,00 €
● F030D23D006	622,00 €
● F030D23D012	622,00 €
● F030D23D018	622,00 €
● F030D23D030	622,00 €
● F030D23D033	622,00 €

3000K

Non Dimmable

○ F030D33A000	530,00 €
○ F030D33A001	530,00 €
● F030D33A006	530,00 €
● F030D33A012	530,00 €
● F030D33A018	530,00 €
● F030D33A030	530,00 €
● F030D33A033	530,00 €
1-10V	
○ F030D33B000	622,00 €
○ F030D33B001	622,00 €
● F030D33B006	622,00 €
● F030D33B012	622,00 €
● F030D33B018	622,00 €
● F030D33B030	622,00 €
● F030D33B033	622,00 €
Dali	
○ F030D33D000	622,00 €
○ F030D33D001	622,00 €
● F030D33D006	622,00 €
● F030D33D012	622,00 €
● F030D33D018	622,00 €
● F030D33D030	622,00 €
● F030D33D033	622,00 €

4000K

Non Dimmable

○ F030D43A000	530,00 €
○ F030D43A001	530,00 €
● F030D43A006	530,00 €
● F030D43A012	530,00 €
● F030D43A018	530,00 €
● F030D43A030	530,00 €
● F030D43A033	530,00 €
1-10V	
○ F030D43B000	622,00 €
○ F030D43B001	622,00 €
● F030D43B006	622,00 €
● F030D43B012	622,00 €
● F030D43B018	622,00 €
● F030D43B030	622,00 €
● F030D43B033	622,00 €
Dali	
○ F030D43D000	622,00 €
○ F030D43D001	622,00 €
● F030D43D006	622,00 €
● F030D43D012	622,00 €
● F030D43D018	622,00 €
● F030D43D030	622,00 €
● F030D43D033	622,00 €

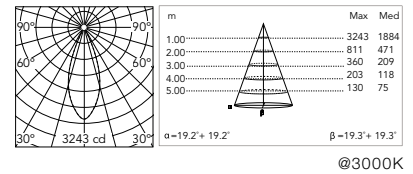

Mile Recessed 2: Accessoires / Accessories

Boîte en métal pour installation sur des plafonds en ciment.

Metal installation box for concrete ceiling.

F030Z020000

117,00 €

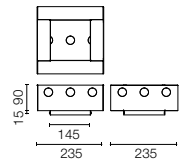

Accessoires pour les versions non dimmables / Accessories for non-dimmable versions

Système de jonction IP68 H2O Stop anti-condensation à 2 voies 4 pôles.

2 way terminal block 4 poles IP68 H2O Stop.

F990C00A000

33,00 €

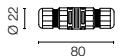

Système de jonction IP68 H2O Stop anti-condensation à 3/4 voies 4 pôles. (Ø5,5÷12mm câble).

3/4 way terminal block 4 poles IP68 H2O Stop. (ø5,5÷12mm cable).

F990C010000

60,00 €



Accessoires pour les versions dimmables / Accessories for dimmable versions

Kit de connecteurs à 5 pôles: fiche volante + fiche EU IP68.

Connector kit 5-pole flying socket + EU plug IP68.

F990C080000

48,00 €



Boitier de dérivation 5 pôles 4 voies (câbles 6-14 mm).

4 way junction box 5 poles IP68 (6-14 mm cables).

F990C030000

62,00 €



Captain Flint

Designed by Michael Anastassiades





Captain Flint



Captain Flint Wall

Famille / Family

Captain Flint Outdoor Floor



CoB Led

11W
1099 lm - 2700K/CRI 80
1140 lm - 3000K/CRI 80
1221 lm - 4000K/CRI 80
2200K available on request.

Captain Flint Outdoor Wall



CoB Led

9,5W
989 lm - 2700K/CRI 80
1026 lm - 3000K/CRI 80
1099 lm - 4000K/CRI 80
2200K available on request.

Captain Flint Outdoor Bollard

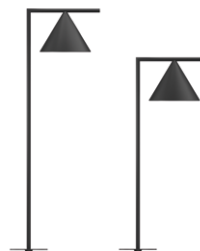

CoB Led

9,5W
989 lm - 2700K/CRI 80
1026 lm - 3000K/CRI 80
1099 lm - 4000K/CRI 80
2200K available on request.

Finitions / Colours



18 Deep Brown



30 Black



37 Burgundy Red



55 Brushed Stainless Steel



59 Brass Finish

Captain Flint Outdoor Floor - Stone bases



18 Deep Brown/Travertino Imperiale



30 Black/Black Lava



37 Burgundy Red/Black Lava



55 Brushed Stainless Steel/
Occhio di Pernice



59 Brass Finish/Grey Lava

Description / Description

Famille de luminaires d'extérieur en versions murales et au sol.

La version murale possède une tête fixe. Rosace, cadre et cône en acier inoxydable 316L poli ou peint, ou en laiton poli. Les parties structurelles sont traitées par procédé de conversion chimique afin d'obtenir une résistance efficace aux agents atmosphériques. Diffuseur en polycarbonate opale anti-UV moulé par injection photogravé. Source de lumière LED incluse.

La version au sol possède une tête orientable à 315° sur tige horizontale, avec une base en pierre robuste, disponible dans différentes finitions. Disponible en cinq combinaisons standard : acier peint noir/lave noire, acier peint deep brown/travertin impérial, rouge bordeaux/lave noire, laiton satiné/lave grise, acier inox satiné/œil de perdrix. Câble adapté pour l'extérieur de 5 mètres de long avec prise Schuko IP44. Interrupteur variateur au pied rétro-éclairé IP65 sur le fil, avec fonctions ON/OFF et réglage du flux lumineux 30-100%.

Luminaire family with wall version, bollard version and outdoor floor version.

Wall version with fixed head. Rose, frame and cone in 316L polished or painted stainless steel or polished brass finishes. Structural parts have been treated with a chemical conversion process for effective resistance against atmospheric conditions. Diffuser in photo-recorded and injection molded UV-resistant opalescent polycarbonate. LED light source included.

Floor version with 315° adjustable head in horizontal rod, with a robust stone base that comes in various finishes. Available in five standard combinations: black/black lava painted steel, deep brown/travertino imperiale, burgundy red/black lava, satinized brass/grey lava, satinized stainless steel/occhio di pernice. 5-m cable with IP44 Schuko plug suitable for outdoor use. Backlit floor dimmer switch along the IP65 cable enables ON/OFF function and 30–100% brightness regulation.

Captain Flint Outdoor Floor

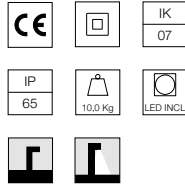
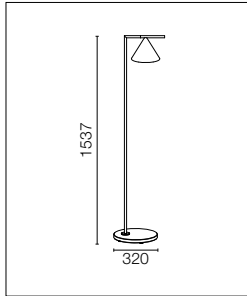

Source LED incluse.
Câble adapté pour l'extérieur de 5 mètres de long avec prise Schuko IP44.
Interrupteur variateur au pied rétro-éclairé IP65 sur le fil, avec fonctions ON/OFF et réglage du flux lumineux 30-100%.
Casambi function on demand.

LED bulb included.
5-m cable with Schuko IP44 plug suitable for outdoor use.
Backlit floor dimmer switch on the IP65 cable enables ON/OFF function and brightness regulation 30-100%.
Casambi function on demand.

2200K disponible sur demande.

2200K available on request.

CoB Led: 11W - 1099 lm ≠ FIXT 669 lm - 2700K/CRI>80 - 220-240V / 11W - 1140 lm ≠ FIXT 694 lm - 3000K/CRI>80 - 220-240V / 11W - 1221 lm ≠ FIXT 744 lm - 4000K/CRI>80 - 220-240V

2700K

● F011A21F018.A	1.717,00 €
● F011A22F030.A	1.717,00 €
● F011A22F037.A	1.717,00 €
● F011A24F055.A	1.943,00 €
● F011A23F059.A	1.943,00 €

3000K

● F011A31F018.A	1.717,00 €
● F011A32F030.A	1.717,00 €
● F011A32F037.A	1.717,00 €
● F011A34F055.A	1.943,00 €
● F011A33F059.A	1.943,00 €

4000K

● F011A41F018.A	1.717,00 €
● F011A42F030.A	1.717,00 €
● F011A42F037.A	1.717,00 €
● F011A44F055.A	1.943,00 €
● F011A43F059.A	1.943,00 €

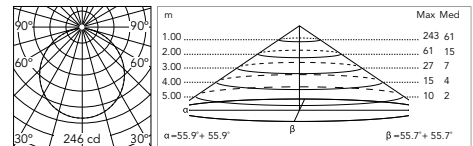

@3000K

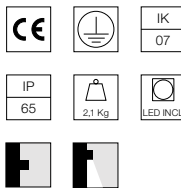
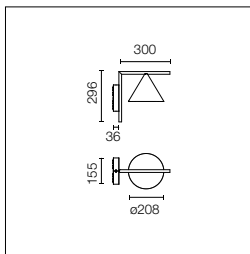

Luminaire pour installation au mur avec émission de lumière diffuse et tête fixe. Source de lumière LED incluse. Alimentation électrique intégrée 220-240V ON/OFF ou réglable 1-10V/DALI. La connexion se fait rapidement à l'intérieur de la rosace avec le raccordement électrique plug&play et le connecteur IP68 inclus. Support de fixation inclus. Version 110V sur demande.

Luminaire for wall-mounting with diffuse light emission and fixed head. LED light source included. Integrated 220-240V ON/OFF or 1-10V/DALI dimmable electrical power. Connection is quickly ensured in the rose with the plug & play electrical connection and the IP68 connector included. Clamp bracket included. 110V version upon request.

2200K disponible sur demande.

2200K available on request.

CoB Led: 9,5W -989 lm ≠ FIXT 629 lm - 2700K/CRI>80 - 220-240V / 9,5W - 1026 lm ≠ FIXT 652 lm - 3000K/CRI>80 - 220-240V / 9,5W -1099 lm ≠ FIXT 699 lm - 4000K/CRI>80 - 220-240V

2700K

Non Dimmable

● F011W20A018	889,00 €
● F011W20A030	889,00 €
● F011W20A037	889,00 €
● F011W20A055	1.033,00 €
● F011W20A059	1.033,00 €
1-10V	
● F011W20B018	978,00 €
● F011W20B030	978,00 €
● F011W20B037	978,00 €
● F011W20B055	1.136,00 €
● F011W20B059	1.136,00 €
Dali	
● F011W20D018	978,00 €
● F011W20D030	978,00 €
● F011W20D037	978,00 €
● F011W20D055	1.136,00 €
● F011W20D059	1.136,00 €

3000K

Non Dimmable

● F011W30A018	889,00 €
● F011W30A030	889,00 €
● F011W30A037	889,00 €
● F011W30A055	1.033,00 €
● F011W30A059	1.033,00 €
1-10V	
● F011W30B018	978,00 €
● F011W30B030	978,00 €
● F011W30B037	978,00 €
● F011W30B055	1.136,00 €
● F011W30B059	1.136,00 €
Dali	
● F011W30D018	978,00 €
● F011W30D030	978,00 €
● F011W30D037	978,00 €
● F011W30D055	1.136,00 €
● F011W30D059	1.136,00 €

4000K

Non Dimmable

● F011W40A018	889,00 €
● F011W40A030	889,00 €
● F011W40A037	889,00 €
● F011W40A055	1.033,00 €
● F011W40A059	1.033,00 €
1-10V	
● F011W40B018	978,00 €
● F011W40B030	978,00 €
● F011W40B037	978,00 €
● F011W40B055	1.136,00 €
● F011W40B059	1.136,00 €
Dali	
● F011W40D018	978,00 €
● F011W40D030	978,00 €
● F011W40D037	978,00 €
● F011W40D055	1.136,00 €
● F011W40D059	1.136,00 €

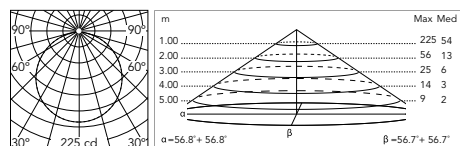

@3000K

Captain Flint Outdoor B1

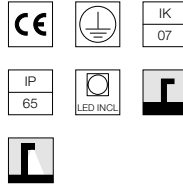
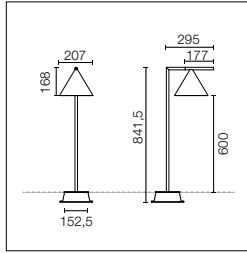

Alimentation électrique ON/OFF ou dimmable 220-240 V intégrée. La source de lumière est équipée d'un câble étanche pour la connexion au réseau électrique. Sur demande : boîtier pour des installations au sol ou pavé nécessitant un socle en ciment.

Integrated ON/OFF or dimmable 220-240V power supply. For mains connection, the light source is equipped with watertight cable. Box for ground or cobblestone installations requiring concrete plinth is available upon request.

2200K disponible sur demande.

2200K available on request.

CoB Led: 9,5W -989 lm ≠ FIXT 629 lm - 2700K/CRI>80 - 220-240V / 9,5W - 1026 lm ≠ FIXT 652 lm - 3000K/CRI>80 - 220-240V / 9,5W -1099 lm ≠ FIXT 699 lm - 4000K/CRI>80 - 220-240V

2700K

Non Dimmable

● F011D20A018	1.225,00 €
● F011D20A030	1.225,00 €
● F011D20A037	1.225,00 €
● F011D20A055	1.327,00 €
● F011D20A059	1.327,00 €
1-10V	
● F011D20B018	1.348,00 €
● F011D20B030	1.348,00 €
● F011D20B037	1.348,00 €
● F011D20B055	1.460,00 €
● F011D20B059	1.460,00 €
Dali	
● F011D20D018	1.348,00 €
● F011D20D030	1.348,00 €
● F011D20D037	1.348,00 €
● F011D20D055	1.460,00 €
● F011D20D059	1.460,00 €

3000K

Non Dimmable

● F011D30A018	1.327,00 €
● F011D30A030	1.327,00 €
● F011D30A037	1.327,00 €
● F011D30A055	1.429,00 €
● F011D30A059	1.429,00 €
1-10V	
● F011D30B018	1.460,00 €
● F011D30B030	1.460,00 €
● F011D30B037	1.460,00 €
● F011D30B055	1.572,00 €
● F011D30B059	1.572,00 €
Dali	
● F011D30D018	1.460,00 €
● F011D30D030	1.460,00 €
● F011D30D037	1.460,00 €
● F011D30D055	1.572,00 €
● F011D30D059	1.572,00 €

4000K

Non Dimmable

● F011D40A018	1.225,00 €
● F011D40A030	1.225,00 €
● F011D40A037	1.225,00 €
● F011D40A055	1.327,00 €
● F011D40A059	1.327,00 €
1-10V	
● F011D40B018	1.348,00 €
● F011D40B030	1.348,00 €
● F011D40B037	1.348,00 €
● F011D40B055	1.460,00 €
● F011D40B059	1.460,00 €
Dali	
● F011D40D018	1.348,00 €
● F011D40D030	1.348,00 €
● F011D40D037	1.348,00 €
● F011D40D055	1.460,00 €
● F011D40D059	1.460,00 €

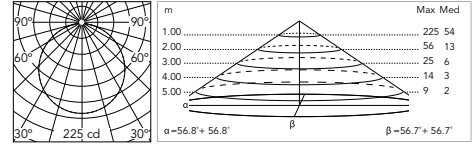

@3000K

Captain Flint Outdoor B2

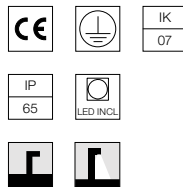
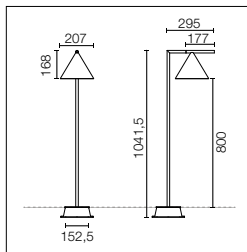

Alimentation électrique ON/OFF ou dimmable 220-240 V intégrée. La source de lumière est équipée d'un câble étanche pour la connexion au réseau électrique. Sur demande : boîtier pour des installations au sol ou pavé nécessitant un socle en ciment.

Integrated ON/OFF or dimmable 220-240V power supply. For mains connection, the light source is equipped with watertight cable. Box for ground or cobblestone installations requiring concrete plinth is available upon request.

2200K disponible sur demande.

2200K available on request.

CoB Led: 9,5W -989 lm ≠ FIXT 629 lm - 2700K/CRI>80 - 220-240V / 9,5W - 1026 lm ≠ FIXT 652 lm - 3000K/CRI>80 - 220-240V / 9,5W -1099 lm ≠ FIXT 699 lm - 4000K/CRI>80 - 220-240V

2700K

Non Dimmable

● F011E20A018	1.327,00 €
● F011E20A030	1.327,00 €
● F011E20A037	1.327,00 €
● F011E20A055	1.429,00 €
● F011E20A059	1.429,00 €
1-10V	
● F011E20B018	1.460,00 €
● F011E20B030	1.460,00 €
● F011E20B037	1.460,00 €
● F011E20B055	1.572,00 €
● F011E20B059	1.572,00 €
Dali	
● F011E20D018	1.460,00 €
● F011E20D030	1.460,00 €
● F011E20D037	1.460,00 €
● F011E20D055	1.572,00 €
● F011E20D059	1.572,00 €

3000K

Non Dimmable

● F011E30A018	1.225,00 €
● F011E30A030	1.225,00 €
● F011E30A037	1.225,00 €
● F011E30A055	1.327,00 €
● F011E30A059	1.327,00 €
1-10V	
● F011E30B018	1.348,00 €
● F011E30B030	1.348,00 €
● F011E30B037	1.348,00 €
● F011E30B055	1.460,00 €
● F011E30B059	1.460,00 €
Dali	
● F011E30D018	1.348,00 €
● F011E30D030	1.348,00 €
● F011E30D037	1.348,00 €
● F011E30D055	1.460,00 €
● F011E30D059	1.460,00 €

4000K



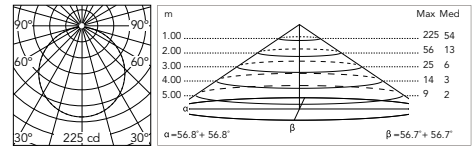

Non Dimmable

● F011E40A018	1.327,00 €
● F011E40A030	1.327,00 €
● F011E40A037	1.327,00 €
● F011E40A055	1.429,00 €
● F011E40A059	1.429,00 €
1-10V	
● F011E40B018	1.460,00 €
● F011E40B030	1.460,00 €
● F011E40B037	1.460,00 €
● F011E40B055	1.572,00 €
● F011E40B059	1.572,00 €
Dali	
● F011E40D018	1.460,00 €
● F011E40D030	1.460,00 €
● F011E40D037	1.460,00 €
● F011E40D055	1.572,00 €
● F011E40D059	1.572,00 €

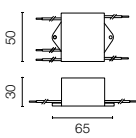

@3000K

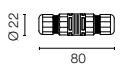
Captain Flint Bollard

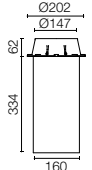
<p>Dispositif de protection contre les surtensions. 275Vac. Courant de décharge maximal 10KA (8/20us). Courant de fonctionnement maximal 5A. Adapté pour les connexions en séries. IP66.</p>	<p>Surge protection device. 275Vac. Maximum discharge current 10KA (8/20us). Maximum operating current 5A. Suitable for series connection. IP66.</p>	<p>F990E00A000</p>	<p>116,00 €</p>		
<p>Système de jonction IP68 H2O Stop anti-condensation à 2 voies 4 pôles.</p>	<p>2 way terminal block 4 poles IP68 H2O Stop.</p>	<p>F990C00A000</p>	<p>33,00 €</p>		
<p>Boitier pour installation au sol.</p>	<p>Box for ground installation.</p>	<p>F018Z000000</p>	<p>59,00 €</p>		

IC Light

Designed by Michael Anastassiades

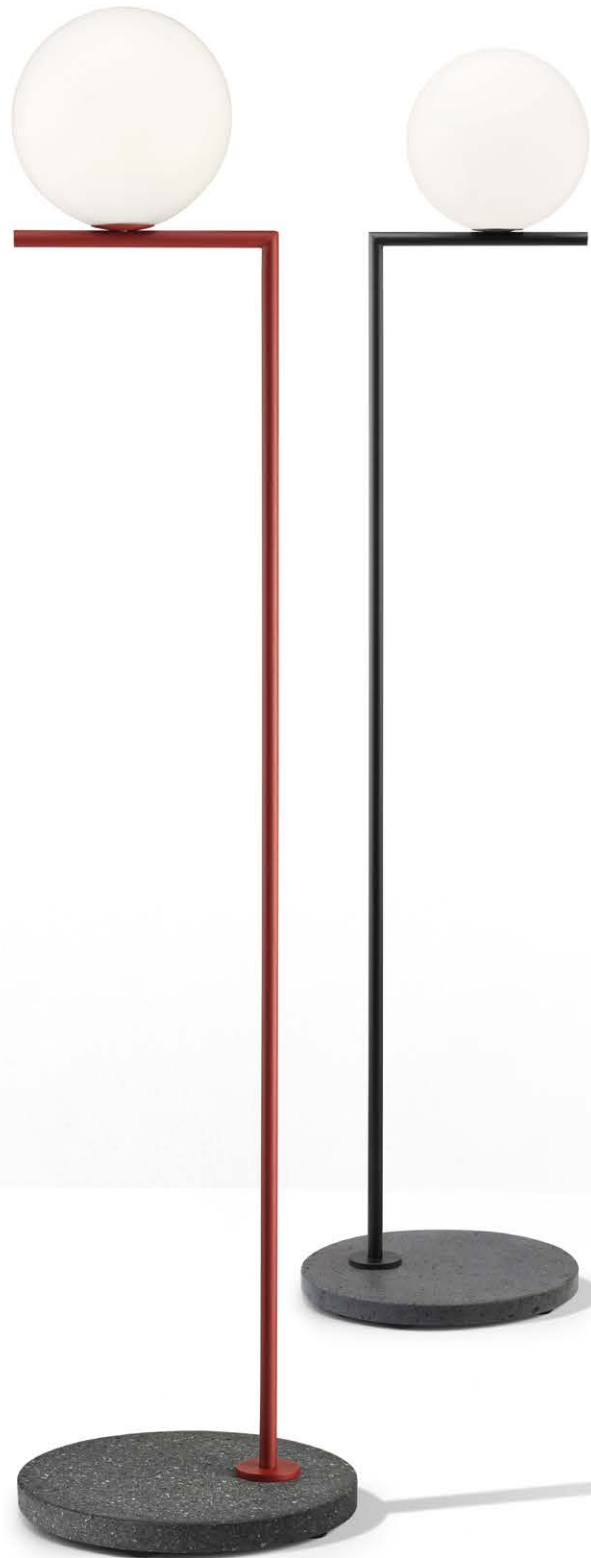



IC Lights Floor

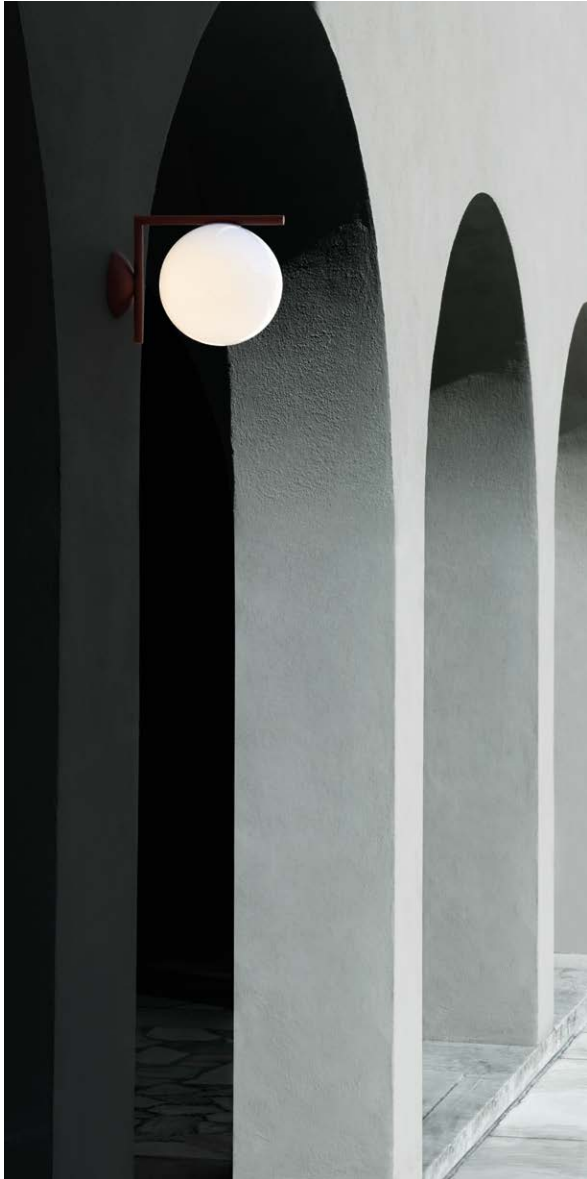

IC Lights Wall



IC Lights Floor

Famille / Family

IC Wall / Ceiling



Led
Max 8W E14

Led
Max 15W E27

IC Floor

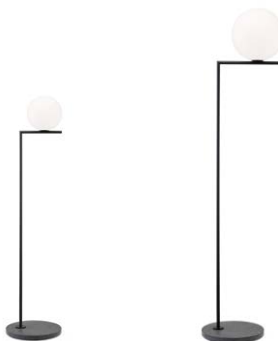

Led
Max 8W E14

Led
Max 15W E27

Finitions / Colours



18 Deep Brown



30 Black



37 Burgundy Red



55 Brushed Stainless Steel



59 Brass Finish

IC Floor Outdoor - Stone bases



30 Black/Black Lava



18 Deep Brown/Travertino Imperiale



37 Burgundy Red/Black Lava



55 Brushed Stainless Steel/
Ochio di Pernice



59 Brass Finish/Grey Lava

Description / Description

Appareil d'éclairage en applique à lumière diffuse pour l'extérieur disponible en deux dimensions. Structure en acier inox brossé, finition laiton brossé ou peint coloris noir mat ou rouge bordeaux. Les parties structurelles de l'appareil sont traitées par procédé de conversion chimique afin d'obtenir une résistance efficace aux agents atmosphériques. Pendant le montage et la maintenance des appareils, il convient de veiller à ne pas endommager le revêtement de peinture à poudres.

Diffuseur opalin en verre soufflé blanc brillant. L'appareil est équipé d'un joint pour une connexion étanche. Source lumineuse E14/E27 non comprise.

Wall- or ceiling-mounted light fitting with diffuse light for exterior use available in two sizes. Frame in brushed stainless steel, brushed brass finish or painted opaque black or burgundy. The structure of the fitting is treated with a chemical conversion process for effective resistance to atmospheric agents. Special attention is recommended during installation and maintenance to prevent damage to the powder coating.

Opalescent diffuser in shiny white translucent blown glass. The light comes with seals for IP-rated connection. Light source with E14/E27 connection not included.

IC Ceiling Wall 1 Outdoor

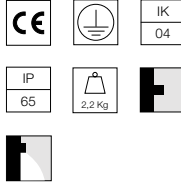
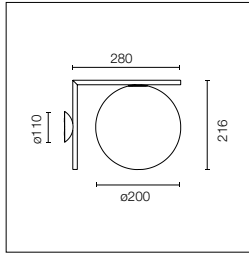

Source lumineuse non comprise. Lampe LED en option à commander séparément. Système de fixation mural contenant le système de câblage. Oeillet d'étanchéité inclus.

Light source excluded. Optional LED bulb sold separately. Wall mounting system contains the wiring system. Watertight cable gland included.

Led: max 8W - E14 - 220-240V

- F012H00C018 460,00 €
- F012H00C030 460,00 €
- F012H00C037 460,00 €
- F012H00C055 627,00 €
- F012H00C059 627,00 €

Accessoires / Accessories

- 1 x LED 8W E14 900lm 3000K cod. RF32291 [e] DIMMER 29,00 €
- 1 x LED 8W E14 900lm 2700K cod. RF32290 [e] DIMMER 29,00 €

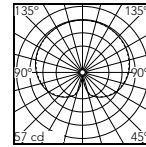

@3000K

IC Ceiling Wall 2 Outdoor

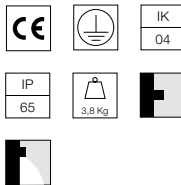
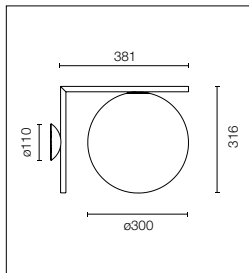

Source lumineuse non comprise. Lampe LED en option à commander séparément. Système de fixation mural contenant le système de câblage. Oeillet d'étanchéité inclus.

Light source excluded. Optional LED bulb sold separately. Wall mounting system contains the wiring system. Watertight cable gland included.

Led: max 15W - E27 - 220-240V

- F012J00C018 616,00 €
- F012J00C030 616,00 €
- F012J00C037 616,00 €
- F012J00C055 764,00 €
- F012J00C059 764,00 €

Accessoires / Accessories

- 1 x LED 15W E27 2000lm 2700K cod. RF32288 [e] DIMMER 46,00 €
- 1 x LED 15W E27 2000lm 3000K cod. RF32289 [e] DIMMER 46,00 €

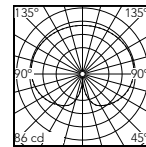

@3000K

IC Floor 1 Outdoor

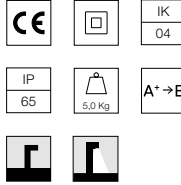
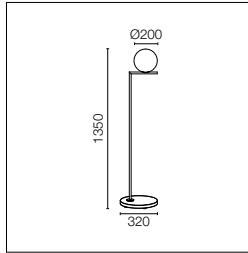

Source non comprise.
Câble adapté pour l'extérieur de 5 mètres de long avec prise Schuko IP44. Interrupteur variateur au pied rétro-éclairé IP65 sur le fil, avec fonctions ON/OFF et réglage du flux lumineux 30-100% (avec lampe LED dimmable).

Bulb not included.
5-m cable with Schuko IP44 plug suitable for outdoor use. Backlit floor dimmer switch on the IP65 cable enables ON/OFF function and brightness regulation 30-100% (with dimmable LED bulb).

Led: max 8W - E14 - 220-240V

- F012A01C018.A 1.028,00 €
- F012A02C030.A 1.028,00 €
- F012A02C037.A 1.028,00 €
- F012A04C055.A 1.195,00 €
- F012A03C059.A 1.195,00 €

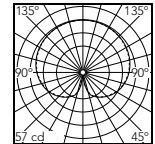

@3000K

Accessoires / Accessories

- 1 x LED 8W E14 900lm 3000K cod. RF32291 [e] DIMMER 29,00 €
- 1 x LED 8W E14 900lm 2700K cod. RF32290 [e] DIMMER 29,00 €

IC Floor 2 Outdoor

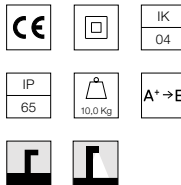
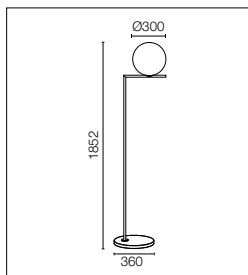

Source non comprise.
Câble adapté pour l'extérieur de 5 mètres de long avec prise Schuko IP44. Interrupteur variateur au pied rétro-éclairé IP65 sur le fil, avec fonctions ON/OFF et réglage du flux lumineux 30-100% (avec lampe LED dimmable).

Bulb not included.
5-m cable with Schuko IP44 plug suitable for outdoor use. Backlit floor dimmer switch on the IP65 cable enables ON/OFF function and brightness regulation 30-100% (with dimmable LED bulb).

Led: max 15W - E27 - 220-240V

- F012B01C018.A 1.297,00 €
- F012B02C030.A 1.297,00 €
- F012B02C037.A 1.297,00 €
- F012B04C055.A 1.505,00 €
- F012B03C059.A 1.505,00 €

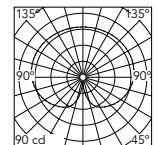

@3000K

Accessoires / Accessories

- 1 x LED 15W E27 2000lm 2700K cod. RF32288 [e] DIMMER 46,00 €
- 1 x LED 15W E27 2000lm 3000K cod. RF32289 [e] DIMMER 46,00 €

Caule

Designed by Patricia Urquiola

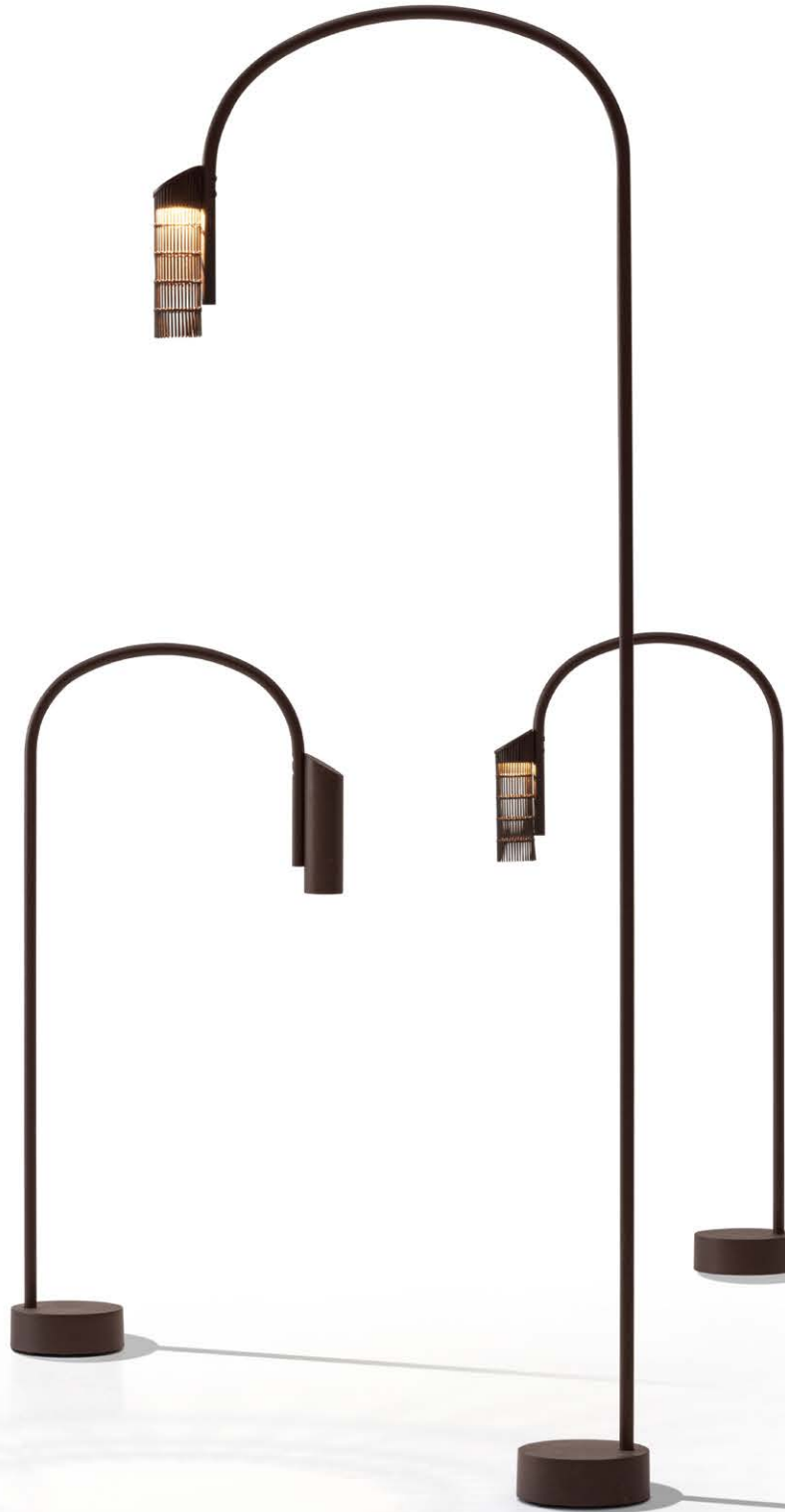



Caule Floor



Caulé Bollard Nest

Famille / Family

Caule Floor

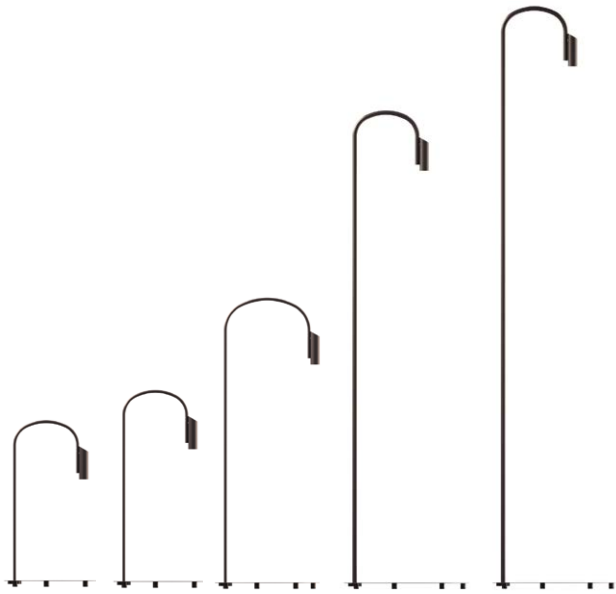

Power Led

5W
282 lm - 2700K/CRI 80
303 lm - 3000K/CRI 80
324 lm - 4000K/CRI 80
2200K available on request.

Caule Floor Nest

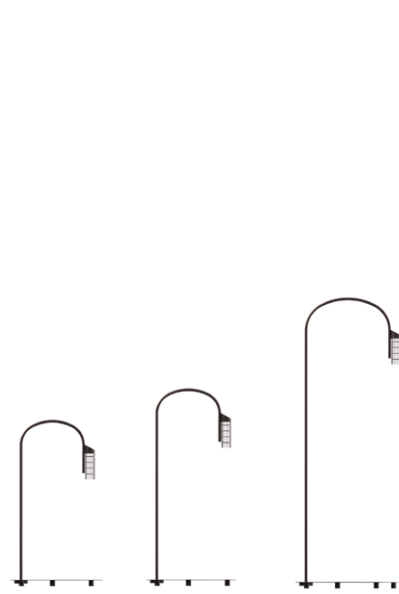

Power Led

5W
282 lm - 2700K/CRI 80
303 lm - 3000K/CRI 80
324 lm - 4000K/CRI 80
2200K available on request.

Caule Bollard



Power Led

5W
282 lm - 2700K/CRI 80
303 lm - 3000K/CRI 80
324 lm - 4000K/CRI 80
2200K available on request.

Caule Bollard Nest



Power Led

5W
282 lm - 2700K/CRI 80
303 lm - 3000K/CRI 80
324 lm - 4000K/CRI 80
2200K available on request.

Finitions / Colours



01 White



06 Grey



12 Forest Green



18 Deep Brown



30 Black



33 Anthracite

Description / Description

Collection d'appareil d'éclairage d'extérieur en version lampadaire et en version bollard, disponibles en différentes hauteurs.

Elles se caractérisent par le design doux et souple de la tige et par deux modèles de tête: une tête monolite pour une lumière directe, une tête cage "Nest" en maille métallique pour une lumière diffuse.

La structure de la tige est en acier inoxydable aisi 304 pour une résistance efficace aux agents atmosphériques. La base est en acier inoxydable aisi 304 pour la version lampadaire mobile et en aluminium moulé sous pression pour la version bollard. La tête, dans laquelle est encastrée la source Led est en maille métallique en acier inoxydable aisi 316L.

Les parties structurelles de l'appareil sont traitées par procédé de conversion chimique afin d'obtenir une résistance efficace à la corrosion des agents atmosphériques.

L'écran de protection de la source lumineuse est en verre sablé pour la tête monolite, en méthacrylate transparent pour la version "Nest".

La version lampadaire est équipée d'un câble prévu pour l'extérieur d'une longueur de 5 mètres avec prise Schuko IP44 et interrupteur variateur à pédale rétro-éclairé IP65 avec fonctions ON/OFF et réglage du flux lumineux.

La version bollard est équipée d'un morceau de câble sortant en néoprène de 200mm de long prêt à être installé sur tous sols. Le boîtier pour une installation sur sol en béton doit être commandé séparément.

Collection of outdoor lighting units in a movable floor lamp version and a bollard version, both available in different heights.

The lamps are characterized by their soft, pliable stem. The lamp head is available in two different models: solid, for direct soft light, or with a 'nest' cover, a metallic mesh creating a unique wash of diffuse light.

The structure of the stem is made of AISI 304 stainless steel for effective resistance to atmospheric agents. The base of the movable floor version is made of AISI 304 stainless steel for and the bollard version is made of die-cast aluminium.

The lamp head, which holds the included LED light source, is made of moulded aluminium; the cover of the 'nest' version is made of a metallic mesh in AISI 316L stainless steel.

The structure is treated with a chemical conversion process for effective resistance to atmospheric agents.

The screen protecting the light source is made of sanded glass for the solid head and methacrylate for the 'nest' version.

The floor lamp version comes with 5 metres of cable appropriate for outdoor use with a Schuko IP44 and IP65 backlit pedal dimmer switch for easy ON/OFF and to adjust the amount of light.

The bollard version comes with a 200-mm length of neoprene cable and is ready for installation on any flooring. Optional accessory (sold separately): box for installation on flooring laid over concrete.

Caule Floor 1

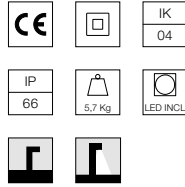
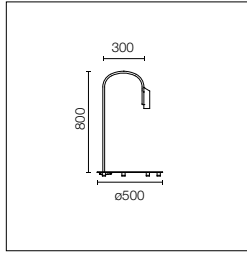

Source lumineuse LED incluse.
Alimentation électrique 220-240V 50-60 Hz intégrée. Câble adapté pour l'extérieur longueur 5 mètres avec prise Schuko IP44. Interrupteur variateur rétroéclairé à pédale IP65 avec fonctions ON/OFF et réglage du flux lumineux.
Version 110V sur demande.
Variateur Control Switch intégré (sur le câble)
Fonction Casambi sur demande.

LED light source included.
Integrated 220-240V 50-60 Hz electrical power. Cable suitable for outdoors, 5-m long with Schuko IP44 plug. IP65 backlit pedal dimmer switch on the cable for easy ON/OFF and to adjust the amount of light.
110V version upon request.
Integrated dimmer control switch (on the cable)
Casambi function on demand.

2200K disponible sur demande.

2200K available on request.

Power Led: 5W - 447 lm ≠ FIXT 282 lm - 2700K/CRI 80 - 220-240V / 5W - 480 lm ≠ FIXT 303 lm - 3000K/CRI 80 - 220-240V / 5W - 513 lm ≠ FIXT 324 lm - 4000K/CRI 80 - 220-240V

2700K

○ F016M21K001.A	1.185,00 €
● F016M21K006.A	1.185,00 €
● F016M21K012.A	1.185,00 €
● F016M21K018.A	1.185,00 €
● F016M21K030.A	1.185,00 €
● F016M21K033.A	1.185,00 €

3000K

○ F016M31K001.A	1.185,00 €
● F016M31K006.A	1.185,00 €
● F016M31K012.A	1.185,00 €
● F016M31K018.A	1.185,00 €
● F016M31K030.A	1.185,00 €
● F016M31K033.A	1.185,00 €

4000K

○ F016M41K001.A	1.185,00 €
● F016M41K006.A	1.185,00 €
● F016M41K012.A	1.185,00 €
● F016M41K018.A	1.185,00 €
● F016M41K030.A	1.185,00 €
● F016M41K033.A	1.185,00 €

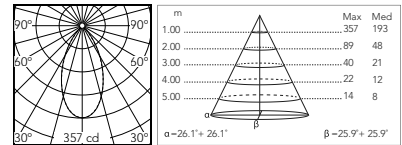

@3000K

Caule Floor 1 Nest

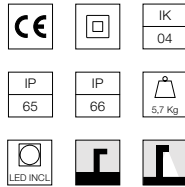
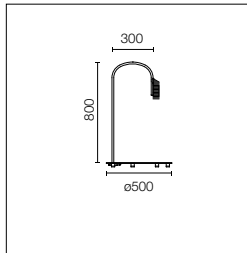

Source lumineuse LED incluse.
Alimentation électrique 220-240V 50-60 Hz intégrée. Câble adapté pour l'extérieur longueur 5 mètres avec prise Schuko IP44. Interrupteur variateur rétroéclairé à pédale IP65 avec fonctions ON/OFF et réglage du flux lumineux.
Version 110V sur demande.
Variateur Control Switch intégré (sur le câble)
Fonction Casambi sur demande.

LED light source included.
Integrated 220-240V 50-60 Hz electrical power. Cable suitable for outdoors, 5-m long with Schuko IP44 plug. IP65 backlit pedal dimmer switch on the cable for easy ON/OFF and to adjust the amount of light.
110V version upon request.
Integrated dimmer control switch (on the cable)
Casambi function on demand.

2200K disponible sur demande.

2200K available on request.

Power Led: 5W - 447 lm ≠ FIXT 124 lm - 2700K/CRI 80 - 220-240V / 5W - 480 lm ≠ FIXT 137 lm - 3000K/CRI 80 - 220-240V / 5W - 513 lm ≠ FIXT 143 lm - 4000K/CRI 80 - 220-240V

2700K

○ F016N21K001.A	1.216,00 €
● F016N21K006.A	1.216,00 €
● F016N21K012.A	1.216,00 €
● F016N21K018.A	1.216,00 €
● F016N21K030.A	1.216,00 €
● F016N21K033.A	1.216,00 €

3000K

○ F016N31K001.A	1.216,00 €
● F016N31K006.A	1.216,00 €
● F016N31K012.A	1.216,00 €
● F016N31K018.A	1.216,00 €
● F016N31K030.A	1.216,00 €
● F016N31K033.A	1.216,00 €

4000K

○ F016N41K001.A	1.216,00 €
● F016N41K006.A	1.216,00 €
● F016N41K012.A	1.216,00 €
● F016N41K018.A	1.216,00 €
● F016N41K030.A	1.216,00 €
● F016N41K033.A	1.216,00 €

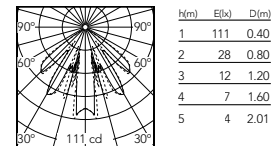

@3000K

Caule Floor 2

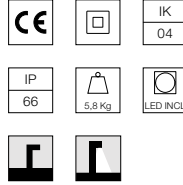
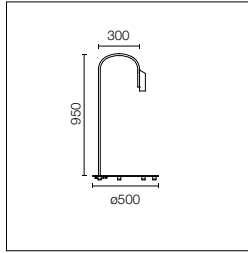

Source lumineuse LED incluse.
Alimentation électrique 220-240V 50-60 Hz intégrée. Câble adapté pour l'extérieur longueur 5 mètres avec prise Schuko IP44. Interrupteur variateur rétroéclairé à pédale IP65 avec fonctions ON/OFF et réglage du flux lumineux.
Version 110V sur demande.
Variateur Control Switch intégré (sur le câble)
Fonction Casambi sur demande.

LED light source included.
Integrated 220-240V 50-60 Hz electrical power. Cable suitable for outdoors, 5-m long with Schuko IP44 plug. IP65 backlit pedal dimmer switch on the cable for easy ON/OFF and to adjust the amount of light.
110V version upon request.
Integrated dimmer control switch (on the cable)
Casambi function on demand.

2200K disponible sur demande.

2200K available on request.

Power Led: 5W - 447 lm ≠ FIXT 282 lm - 2700K/CRI 80 - 220-240V / 5W - 480 lm ≠ FIXT 303 lm - 3000K/CRI 80 - 220-240V / 5W - 513 lm ≠ FIXT 324 lm - 4000K/CRI 80 - 220-240V

2700K

- F016M22K001.A 1.339,00 €
- F016M22K006.A 1.339,00 €
- F016M22K012.A 1.339,00 €
- F016M22K018.A 1.339,00 €
- F016M22K030.A 1.339,00 €
- F016M22K033.A 1.339,00 €

3000K

- F016M32K001.A 1.339,00 €
- F016M32K006.A 1.339,00 €
- F016M32K012.A 1.339,00 €
- F016M32K018.A 1.339,00 €
- F016M32K030.A 1.339,00 €
- F016M32K033.A 1.339,00 €

4000K

- F016M42K001.A 1.339,00 €
- F016M42K006.A 1.339,00 €
- F016M42K012.A 1.339,00 €
- F016M42K018.A 1.339,00 €
- F016M42K030.A 1.339,00 €
- F016M42K033.A 1.339,00 €

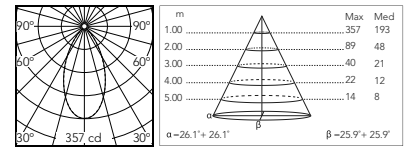

@3000K

Caule Floor 2 Nest

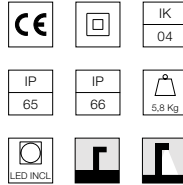
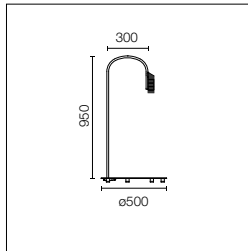
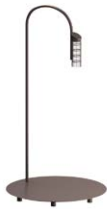

Source lumineuse LED incluse.
Alimentation électrique 220-240V 50-60 Hz intégrée. Câble adapté pour l'extérieur longueur 5 mètres avec prise Schuko IP44. Interrupteur variateur rétroéclairé à pédale IP65 avec fonctions ON/OFF et réglage du flux lumineux.
Version 110V sur demande.
Variateur Control Switch intégré (sur le câble)
Fonction Casambi sur demande.

LED light source included.
Integrated 220-240V 50-60 Hz electrical power. Cable suitable for outdoors, 5-m long with Schuko IP44 plug. IP65 backlit pedal dimmer switch on the cable for easy ON/OFF and to adjust the amount of light.
110V version upon request.
Integrated dimmer control switch (on the cable)
Casambi function on demand.

2200K disponible sur demande.

2200K available on request.

Power Led: 5W - 447 lm ≠ FIXT 124 lm - 2700K/CRI 80 - 220-240V / 5W - 480 lm ≠ FIXT 137 lm - 3000K/CRI 80 - 220-240V / 5W - 513 lm ≠ FIXT 143 lm - 4000K/CRI 80 - 220-240V

2700K

- F016N22K001.A 1.370,00 €
- F016N22K006.A 1.370,00 €
- F016N22K012.A 1.370,00 €
- F016N22K018.A 1.370,00 €
- F016N22K030.A 1.370,00 €
- F016N22K033.A 1.370,00 €

3000K

- F016N32K001.A 1.370,00 €
- F016N32K006.A 1.370,00 €
- F016N32K012.A 1.370,00 €
- F016N32K018.A 1.370,00 €
- F016N32K030.A 1.370,00 €
- F016N32K033.A 1.370,00 €

4000K

- F016N42K001.A 1.370,00 €
- F016N42K006.A 1.370,00 €
- F016N42K012.A 1.370,00 €
- F016N42K018.A 1.370,00 €
- F016N42K030.A 1.370,00 €
- F016N42K033.A 1.370,00 €

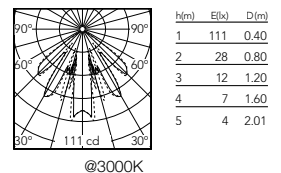

@3000K

Caule Floor 3

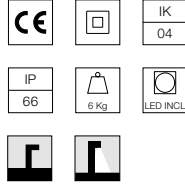
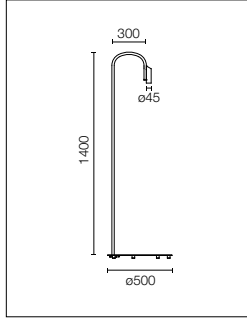

Source lumineuse LED incluse.
Alimentation électrique 220-240V 50-60 Hz intégrée. Câble adapté pour l'extérieur longueur 5 mètres avec prise Schuko IP44. Interrupteur variateur rétroéclairé à pédale IP65 avec fonctions ON/OFF et réglage du flux lumineux.
Version 110V sur demande.
Variateur Control Switch intégré (sur le câble)
Fonction Casambi sur demande.

LED light source included.
Integrated 220-240V 50-60 Hz electrical power. Cable suitable for outdoors, 5-m long with Schuko IP44 plug. IP65 backlit pedal dimmer switch on the cable for easy ON/OFF and to adjust the amount of light.
110V version upon request.
Integrated dimmer control switch (on the cable)
Casambi function on demand.

2200K disponible sur demande.

2200K available on request.

Power Led: 5W - 447 lm ≠ FIXT 282 lm - 2700K/CRI 80 - 220-240V / 5W - 480 lm ≠ FIXT 303 lm - 3000K/CRI 80 - 220-240V / 5W - 513 lm ≠ FIXT 324 lm - 4000K/CRI 80 - 220-240V

2700K

- F016M23K001.A 1.370,00 €
- F016M23K006.A 1.370,00 €
- F016M23K012.A 1.370,00 €
- F016M23K018.A 1.370,00 €
- F016M23K030.A 1.370,00 €
- F016M23K033.A 1.370,00 €

3000K

- F016M33K001.A 1.370,00 €
- F016M33K006.A 1.370,00 €
- F016M33K012.A 1.370,00 €
- F016M33K018.A 1.370,00 €
- F016M33K030.A 1.370,00 €
- F016M33K033.A 1.370,00 €

4000K

- F016M43K001.A 1.370,00 €
- F016M43K006.A 1.370,00 €
- F016M43K012.A 1.370,00 €
- F016M43K018.A 1.370,00 €
- F016M43K030.A 1.370,00 €
- F016M43K033.A 1.370,00 €

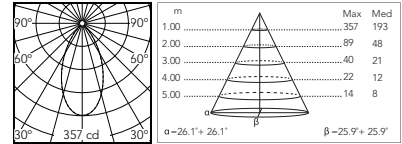

@3000K

Caule Floor 3 Nest

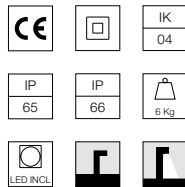
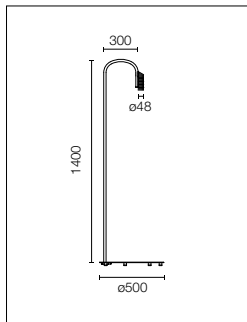

Source lumineuse LED incluse.
Alimentation électrique 220-240V 50-60 Hz intégrée. Câble adapté pour l'extérieur longueur 5 mètres avec prise Schuko IP44. Interrupteur variateur rétroéclairé à pédale IP65 avec fonctions ON/OFF et réglage du flux lumineux.
Version 110V sur demande.
Variateur Control Switch intégré (sur le câble)
Fonction Casambi sur demande.

LED light source included.
Integrated 220-240V 50-60 Hz electrical power. Cable suitable for outdoors, 5-m long with Schuko IP44 plug. IP65 backlit pedal dimmer switch on the cable for easy ON/OFF and to adjust the amount of light.
110V version upon request.
Integrated dimmer control switch (on the cable)
Casambi function on demand.

2200K disponible sur demande.

2200K available on request.

Power Led: 5W - 447 lm ≠ FIXT 124 lm - 2700K/CRI 80 - 220-240V / 5W - 480 lm ≠ FIXT 137 lm - 3000K/CRI 80 - 220-240V / 5W - 513 lm ≠ FIXT 143 lm - 4000K/CRI 80 - 220-240V

2700K

- F016N23K001.A 1.402,00 €
- F016N23K006.A 1.402,00 €
- F016N23K012.A 1.402,00 €
- F016N23K018.A 1.402,00 €
- F016N23K030.A 1.402,00 €
- F016N23K033.A 1.402,00 €

3000K

- F016N33K001.A 1.402,00 €
- F016N33K006.A 1.402,00 €
- F016N33K012.A 1.402,00 €
- F016N33K018.A 1.402,00 €
- F016N33K030.A 1.402,00 €
- F016N33K033.A 1.402,00 €

4000K

- F016N43K001.A 1.402,00 €
- F016N43K006.A 1.402,00 €
- F016N43K012.A 1.402,00 €
- F016N43K018.A 1.402,00 €
- F016N43K030.A 1.402,00 €
- F016N43K033.A 1.402,00 €

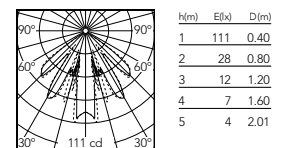

@3000K

Caule Floor 4

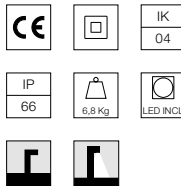
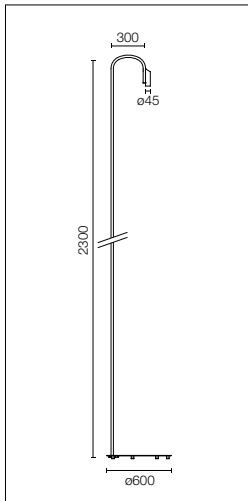

Source lumineuse LED incluse.
Alimentation électrique 220-240V 50-60 Hz intégrée. Câble adapté pour l'extérieur longueur 5 mètres avec prise Schuko IP44. Interrupteur variateur rétroéclairé à pédale IP65 avec fonctions ON/OFF et réglage du flux lumineux.
Version 110V sur demande.
Variateur Control Switch intégré (sur le câble)
Fonction Casambi sur demande.

LED light source included.
Integrated 220-240V 50-60 Hz electrical power. Cable suitable for outdoors, 5-m long with Schuko IP44 plug. IP65 backlit pedal dimmer switch on the cable for easy ON/OFF and to adjust the amount of light.
110V version upon request.
Integrated dimmer control switch (on the cable)
Casambi function on demand.

2200K disponible sur demande.

2200K available on request.

Power Led: 5W - 447 lm ≠ FIXT 245 lm - 2700K/CRI 80 - 220-240V / 5W - 480 lm ≠ FIXT 263 lm - 3000K/CRI 80 - 220-240V / 5W - 513 lm ≠ FIXT 281 lm - 4000K/CRI 80 - 220-240V

2700K

- F016M24K001.A 1.607,00 €
- F016M24K006.A 1.607,00 €
- F016M24K012.A 1.607,00 €
- F016M24K018.A 1.607,00 €
- F016M24K030.A 1.607,00 €
- F016M24K033.A 1.607,00 €

3000K

- F016M34K001.A 1.607,00 €
- F016M34K006.A 1.607,00 €
- F016M34K012.A 1.607,00 €
- F016M34K018.A 1.607,00 €
- F016M34K030.A 1.607,00 €
- F016M34K033.A 1.607,00 €

4000K

- F016M44K001.A 1.607,00 €
- F016M44K006.A 1.607,00 €
- F016M44K012.A 1.607,00 €
- F016M44K018.A 1.607,00 €
- F016M44K030.A 1.607,00 €
- F016M44K033.A 1.607,00 €

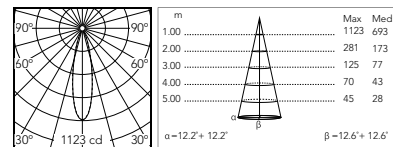

@3000K

Caule Floor 5

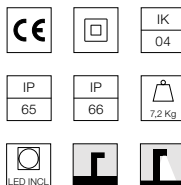
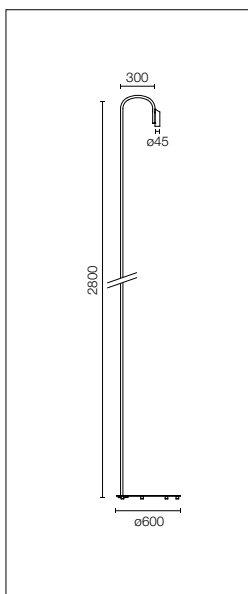

Source lumineuse LED incluse.
Alimentation électrique 220-240V 50-60 Hz intégrée. Câble adapté pour l'extérieur longueur 5 mètres avec prise Schuko IP44. Interrupteur variateur rétroéclairé à pédale IP65 avec fonctions ON/OFF et réglage du flux lumineux.
Version 110V sur demande.
Variateur Control Switch intégré (sur le câble)
Fonction Casambi sur demande.

LED light source included.
Integrated 220-240V 50-60 Hz electrical power. Cable suitable for outdoors, 5-m long with Schuko IP44 plug. IP65 backlit pedal dimmer switch on the cable for easy ON/OFF and to adjust the amount of light.
110V version upon request.
Integrated dimmer control switch (on the cable)
Casambi function on demand.

2200K disponible sur demande.

2200K available on request.

Power Led: 5W - 447 lm ≠ FIXT 245 lm - 2700K/CRI 80 - 220-240V / 5W - 480 lm ≠ FIXT 263 lm - 3000K/CRI 80 - 220-240V / 5W - 513 lm ≠ FIXT 281 lm - 4000K/CRI 80 - 220-240V

2700K

- F016M25K001.A 1.679,00 €
- F016M25K006.A 1.679,00 €
- F016M25K012.A 1.679,00 €
- F016M25K018.A 1.679,00 €
- F016M25K030.A 1.679,00 €
- F016M25K033.A 1.679,00 €

3000K

- F016M35K001.A 1.679,00 €
- F016M35K006.A 1.679,00 €
- F016M35K012.A 1.679,00 €
- F016M35K018.A 1.679,00 €
- F016M35K030.A 1.679,00 €
- F016M35K033.A 1.679,00 €

4000K

- F016M45K001.A 1.679,00 €
- F016M45K006.A 1.679,00 €
- F016M45K012.A 1.679,00 €
- F016M45K018.A 1.679,00 €
- F016M45K030.A 1.679,00 €
- F016M45K033.A 1.679,00 €

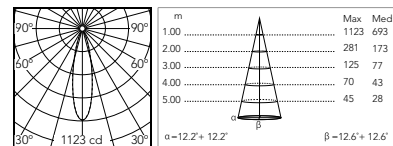

@3000K

Caule Bollard 1

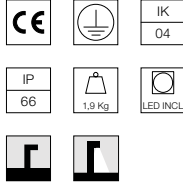
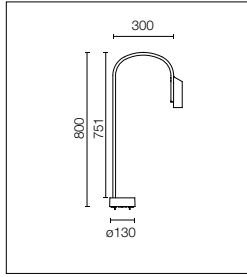

Source lumineuse LED incluse.
Alimentation électrique ON/
OFF ou variable 220-240V
intégrée. L'appareil peut être
installé sur tous les sols à l'aide
de chevilles. Le boîtier pour
une installation en surface
avec socle en béton doit être
commandé séparément.
Version 110V sur demande.

LED light source included.
Integrated 220-240V ON/OFF or
dimnable electrical power. The
device may be installed on any
flooring with anchors. Box for
installation on flooring laid over
concrete sold separately.
110V version upon request.

2200K disponible sur demande.

2200K available on request.

Power Led: 5W - 447 lm ≠ FIXT 282 lm - 2700K/CRI 80 - 220-240V / 5W - 480 lm ≠ FIXT 303 lm - 3000K/CRI 80 - 220-240V / 5W - 513 lm ≠ FIXT 324 lm - 4000K/CRI 80 - 220-240V

2700K

Non Dimmable

○ F016A21A001	656,00 €
● F016A21A006	656,00 €
● F016A21A012	656,00 €
● F016A21A018	656,00 €
● F016A21A030	656,00 €
● F016A21A033	656,00 €
1-10V	
○ F016A21B001	795,00 €
● F016A21B006	795,00 €
● F016A21B012	795,00 €
● F016A21B018	795,00 €
● F016A21B030	795,00 €
● F016A21B033	795,00 €
Dali	
○ F016A21D001	795,00 €
● F016A21D006	795,00 €
● F016A21D012	795,00 €
● F016A21D018	795,00 €
● F016A21D030	795,00 €
● F016A21D033	795,00 €

3000K

Non Dimmable

○ F016A31A001	656,00 €
● F016A31A006	656,00 €
● F016A31A012	656,00 €
● F016A31A018	656,00 €
● F016A31A030	656,00 €
● F016A31A033	656,00 €
1-10V	
○ F016A31B001	795,00 €
● F016A31B006	795,00 €
● F016A31B012	795,00 €
● F016A31B018	795,00 €
● F016A31B030	795,00 €
● F016A31B033	795,00 €
Dali	
○ F016A31D001	795,00 €
● F016A31D006	795,00 €
● F016A31D012	795,00 €
● F016A31D018	795,00 €
● F016A31D030	795,00 €
● F016A31D033	795,00 €

4000K

Non Dimmable

○ F016A41A001	656,00 €
● F016A41A006	656,00 €
● F016A41A012	656,00 €
● F016A41A018	656,00 €
● F016A41A030	656,00 €
● F016A41A033	656,00 €
1-10V	
○ F016A41B001	795,00 €
● F016A41B006	795,00 €
● F016A41B012	795,00 €
● F016A41B018	795,00 €
● F016A41B030	795,00 €
● F016A41B033	795,00 €
Dali	
○ F016A41D001	795,00 €
● F016A41D006	795,00 €
● F016A41D012	795,00 €
● F016A41D018	795,00 €
● F016A41D030	795,00 €
● F016A41D033	795,00 €

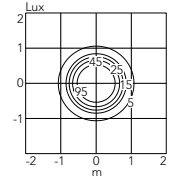
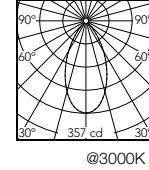

Caule Bollard 1 Nest

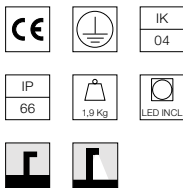
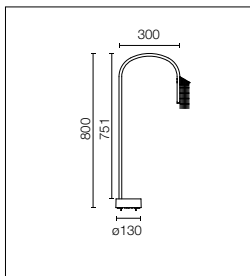

Source lumineuse LED incluse.
Alimentation électrique ON/OFF ou variable 220-240V intégrée. L'appareil peut être installé sur tous les sols à l'aide de chevilles. Le boîtier pour une installation en surface avec socle en béton doit être commandé séparément.
Version 110V sur demande.

LED light source included. Integrated 220-240V ON/OFF or dimmable electrical power. The device may be installed on any flooring with anchors. Box for installation on flooring laid over concrete sold separately.
110V version upon request.

2200K disponible sur demande.

2200K available on request.

Power Led: 5W - 447 lm ≠ FIXT 124 lm - 2700K/CRI 80 - 220-240V / 5W - 480 lm ≠ FIXT 137 lm - 3000K/CRI 80 - 220-240V / 5W - 513 lm ≠ FIXT 143 lm - 4000K/CRI 80 - 220-240V

2700K

Non Dimmable	
○ F016B21A001	684,00 €
● F016B21A006	684,00 €
● F016B21A012	684,00 €
● F016B21A018	684,00 €
● F016B21A030	684,00 €
● F016B21A033	684,00 €
1-10V	
○ F016B21B001	829,00 €
● F016B21B006	829,00 €
● F016B21B012	829,00 €
● F016B21B018	829,00 €
● F016B21B030	829,00 €
● F016B21B033	829,00 €
Dali	
○ F016B21D001	829,00 €
● F016B21D006	829,00 €
● F016B21D012	829,00 €
● F016B21D018	829,00 €
● F016B21D030	829,00 €
● F016B21D033	829,00 €

3000K

Non Dimmable	
○ F016B31A001	684,00 €
● F016B31A006	684,00 €
● F016B31A012	684,00 €
● F016B31A018	684,00 €
● F016B31A030	684,00 €
● F016B31A033	684,00 €
1-10V	
○ F016B31B001	829,00 €
● F016B31B006	829,00 €
● F016B31B012	829,00 €
● F016B31B018	829,00 €
● F016B31B030	829,00 €
● F016B31B033	829,00 €
Dali	
○ F016B31D001	829,00 €
● F016B31D006	829,00 €
● F016B31D012	829,00 €
● F016B31D018	829,00 €
● F016B31D030	829,00 €
● F016B31D033	829,00 €

4000K

Non Dimmable	
○ F016B41A001	684,00 €
● F016B41A006	684,00 €
● F016B41A012	684,00 €
● F016B41A018	684,00 €
● F016B41A030	684,00 €
● F016B41A033	684,00 €
1-10V	
○ F016B41B001	829,00 €
● F016B41B006	829,00 €
● F016B41B012	829,00 €
● F016B41B018	829,00 €
● F016B41B030	829,00 €
● F016B41B033	829,00 €
Dali	
○ F016B41D001	829,00 €
● F016B41D006	829,00 €
● F016B41D012	829,00 €
● F016B41D018	829,00 €
● F016B41D030	829,00 €
● F016B41D033	829,00 €

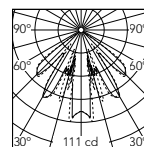

h(m)	E(lx)	D(m)
1	111	0.40
2	28	0.80
3	12	1.20
4	7	1.60
5	4	2.01

@3000K

Caule Bollard 2

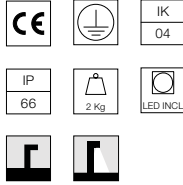
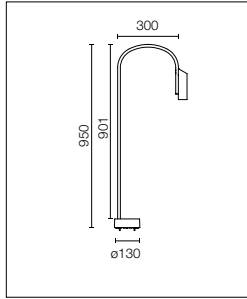

Source lumineuse LED incluse.
Alimentation électrique ON/
OFF ou variable 220-240V
intégrée. L'appareil peut être
installé sur tous les sols à l'aide
de chevilles. Le boîtier pour
une installation en surface
avec socle en béton doit être
commandé séparément.
Version 110V sur demande.

LED light source included.
Integrated 220-240V ON/OFF or
dimmable electrical power. The
device may be installed on any
flooring with anchors. Box for
installation on flooring laid over
concrete sold separately.
110V version upon request.

2200K disponible sur demande.

2200K available on request.

Power Led: 5W - 447 lm ≠ FIXT 282 lm - 2700K/CRI 80 - 220-240V / 5W - 480 lm ≠ FIXT 303 lm - 3000K/CRI 80 - 220-240V /
5W - 513 lm ≠ FIXT 324 lm - 4000K/CRI 80 - 220-240V

2700K

Non Dimmable

○ F016A22A001	684,00 €
● F016A22A006	684,00 €
● F016A22A012	684,00 €
● F016A22A018	684,00 €
● F016A22A030	684,00 €
● F016A22A033	684,00 €
1-10V	
○ F016A22B001	829,00 €
● F016A22B006	829,00 €
● F016A22B012	829,00 €
● F016A22B018	829,00 €
● F016A22B030	829,00 €
● F016A22B033	829,00 €
Dali	
○ F016A22D001	829,00 €
● F016A22D006	829,00 €
● F016A22D012	829,00 €
● F016A22D018	829,00 €
● F016A22D030	829,00 €
● F016A22D033	829,00 €

3000K

Non Dimmable

○ F016A32A001	684,00 €
● F016A32A006	684,00 €
● F016A32A012	684,00 €
● F016A32A018	684,00 €
● F016A32A030	684,00 €
● F016A32A033	684,00 €
1-10V	
○ F016A32B001	829,00 €
● F016A32B006	829,00 €
● F016A32B012	829,00 €
● F016A32B018	829,00 €
● F016A32B030	829,00 €
● F016A32B033	829,00 €
Dali	
○ F016A32D001	829,00 €
● F016A32D006	829,00 €
● F016A32D012	829,00 €
● F016A32D018	829,00 €
● F016A32D030	829,00 €
● F016A32D033	829,00 €

4000K

Non Dimmable

○ F016A42A001	684,00 €
● F016A42A006	684,00 €
● F016A42A012	684,00 €
● F016A42A018	684,00 €
● F016A42A030	684,00 €
● F016A42A033	684,00 €
1-10V	
○ F016A42B001	829,00 €
● F016A42B006	829,00 €
● F016A42B012	829,00 €
● F016A42B018	829,00 €
● F016A42B030	829,00 €
● F016A42B033	829,00 €
Dali	
○ F016A42D001	829,00 €
● F016A42D006	829,00 €
● F016A42D012	829,00 €
● F016A42D018	829,00 €
● F016A42D030	829,00 €
● F016A42D033	829,00 €

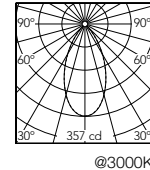

@3000K

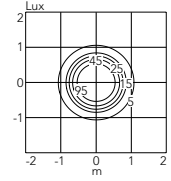

Caule Bollard 2 Nest

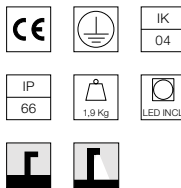
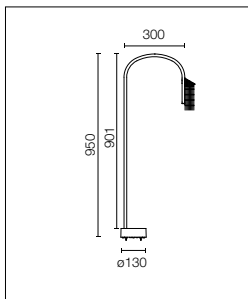

Source lumineuse LED incluse.
Alimentation électrique ON/OFF ou variable 220-240V intégrée. L'appareil peut être installé sur tous les sols à l'aide de chevilles. Le boîtier pour une installation en surface avec socle en béton doit être commandé séparément.
Version 110V sur demande.

LED light source included. Integrated 220-240V ON/OFF or dimmable electrical power. The device may be installed on any flooring with anchors. Box for installation on flooring laid over concrete sold separately.
110V version upon request.

2200K disponible sur demande.

2200K available on request.

Power Led: 5W - 447 lm ≠ FIXT 124 lm - 2700K/CRI 80 - 220-240V / 5W - 480 lm ≠ FIXT 137 lm - 3000K/CRI 80 - 220-240V / 5W - 513 lm ≠ FIXT 143 lm - 4000K/CRI 80 - 220-240V

2700K

Non Dimmable	
○ F016B22A001	712,00 €
● F016B22A006	712,00 €
● F016B22A012	712,00 €
● F016B22A018	712,00 €
● F016B22A030	712,00 €
● F016B22A033	712,00 €
1-10V	
○ F016B22B001	859,00 €
● F016B22B006	859,00 €
● F016B22B012	859,00 €
● F016B22B018	859,00 €
● F016B22B030	859,00 €
● F016B22B033	859,00 €
Dali	
○ F016B22D001	859,00 €
● F016B22D006	859,00 €
● F016B22D012	859,00 €
● F016B22D018	859,00 €
● F016B22D030	859,00 €
● F016B22D033	859,00 €

3000K

Non Dimmable	
○ F016B32A001	712,00 €
● F016B32A006	712,00 €
● F016B32A012	712,00 €
● F016B32A018	712,00 €
● F016B32A030	712,00 €
● F016B32A033	712,00 €
1-10V	
○ F016B32B001	859,00 €
● F016B32B006	859,00 €
● F016B32B012	859,00 €
● F016B32B018	859,00 €
● F016B32B030	859,00 €
● F016B32B033	859,00 €
Dali	
○ F016B32D001	859,00 €
● F016B32D006	859,00 €
● F016B32D012	859,00 €
● F016B32D018	859,00 €
● F016B32D030	859,00 €
● F016B32D033	859,00 €

4000K

Non Dimmable	
○ F016B42A001	712,00 €
● F016B42A006	712,00 €
● F016B42A012	712,00 €
● F016B42A018	712,00 €
● F016B42A030	712,00 €
● F016B42A033	712,00 €
1-10V	
○ F016B42B001	859,00 €
● F016B42B006	859,00 €
● F016B42B012	859,00 €
● F016B42B018	859,00 €
● F016B42B030	859,00 €
● F016B42B033	859,00 €
Dali	
○ F016B42D001	859,00 €
● F016B42D006	859,00 €
● F016B42D012	859,00 €
● F016B42D018	859,00 €
● F016B42D030	859,00 €
● F016B42D033	859,00 €

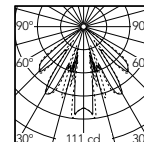

h(m)	E _h (lx)	D(m)
1	111	0.40
2	28	0.80
3	12	1.20
4	7	1.60
5	4	2.01

@3000K

Caule Bollard 3

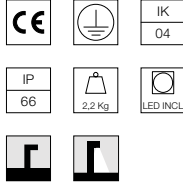
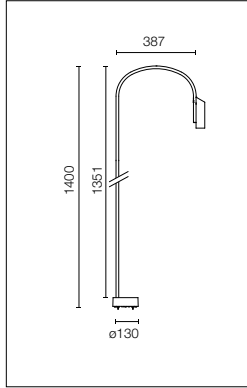
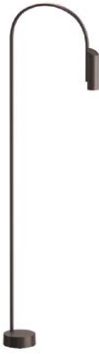

Source lumineuse LED incluse.
Alimentation électrique ON/
OFF ou variable 220-240V
intégrée. L'appareil peut être
installé sur tous les sols à l'aide
de chevilles. Le boîtier pour
une installation en surface
avec socle en béton doit être
commandé séparément.
Version 110V sur demande.

LED light source included.
Integrated 220-240V ON/OFF or
dimmable electrical power. The
device may be installed on any
flooring with anchors. Box for
installation on flooring laid over
concrete sold separately.
110V version upon request.

2200K disponible sur demande.

2200K available on request.

Power Led: 5W - 447 lm ≠ FIXT 282 lm - 2700K/CRI 80 - 220-240V / 5W - 480 lm ≠ FIXT 303 lm - 3000K/CRI 80 - 220-240V /
5W - 513 lm ≠ FIXT 324 lm - 4000K/CRI 80 - 220-240V

2700K

Non Dimmable

○ F016A23A001	712,00 €
● F016A23A006	712,00 €
● F016A23A012	712,00 €
● F016A23A018	712,00 €
● F016A23A030	712,00 €
● F016A23A033	712,00 €
1-10V	
○ F016A23B001	859,00 €
● F016A23B006	859,00 €
● F016A23B012	859,00 €
● F016A23B018	859,00 €
● F016A23B030	859,00 €
● F016A23B033	859,00 €

Dali

○ F016A23D001	859,00 €
● F016A23D006	859,00 €
● F016A23D012	859,00 €
● F016A23D018	859,00 €
● F016A23D030	859,00 €
● F016A23D033	859,00 €

3000K

Non Dimmable

○ F016A33A001	712,00 €
● F016A33A006	712,00 €
● F016A33A012	712,00 €
● F016A33A018	712,00 €
● F016A33A030	712,00 €
● F016A33A033	712,00 €
1-10V	
○ F016A33B001	859,00 €
● F016A33B006	859,00 €
● F016A33B012	859,00 €
● F016A33B018	859,00 €
● F016A33B030	859,00 €
● F016A33B033	859,00 €

Dali

○ F016A33D001	859,00 €
● F016A33D006	859,00 €
● F016A33D012	859,00 €
● F016A33D018	859,00 €
● F016A33D030	859,00 €
● F016A33D033	859,00 €

4000K

Non Dimmable

○ F016A43A001	712,00 €
● F016A43A006	712,00 €
● F016A43A012	712,00 €
● F016A43A018	712,00 €
● F016A43A030	712,00 €
● F016A43A033	712,00 €
1-10V	
○ F016A43B001	859,00 €
● F016A43B006	859,00 €
● F016A43B012	859,00 €
● F016A43B018	859,00 €
● F016A43B030	859,00 €
● F016A43B033	859,00 €

Dali

○ F016A43D001	859,00 €
● F016A43D006	859,00 €
● F016A43D012	859,00 €
● F016A43D018	859,00 €
● F016A43D030	859,00 €
● F016A43D033	859,00 €

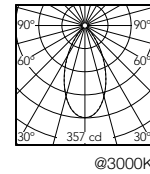

@3000K

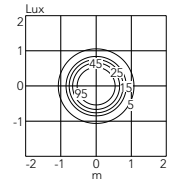

Caule Bollard 3 Nest

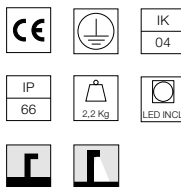
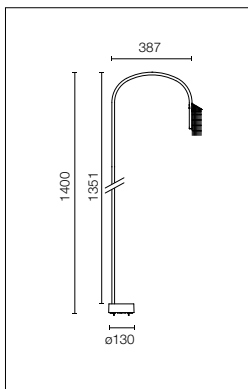
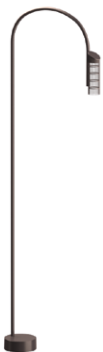

Source lumineuse LED incluse. Alimentation électrique ON/OFF ou variable 220-240V intégrée. L'appareil peut être installé sur tous les sols à l'aide de chevilles. Le boîtier pour une installation en surface avec socle en béton doit être commandé séparément. Version 110V sur demande.

LED light source included. Integrated 220-240V ON/OFF or dimmable electrical power. The device may be installed on any flooring with anchors. Box for installation on flooring laid over concrete sold separately. 110V version upon request.

2200K disponible sur demande.

2200K available on request.

Power Led: 5W - 447 lm ≠ FIXT 124 lm - 2700K/CRI 80 - 220-240V / 5W - 480 lm ≠ FIXT 137 lm - 3000K/CRI 80 - 220-240V / 5W - 513 lm ≠ FIXT 143 lm - 4000K/CRI 80 - 220-240V

2700K		3000K		4000K	
Non Dimmable		Non Dimmable		Non Dimmable	
○ F016B23A001	741,00 €	○ F016B33A001	741,00 €	○ F016B43A001	741,00 €
● F016B23A006	741,00 €	● F016B33A006	741,00 €	● F016B43A006	741,00 €
● F016B23A012	741,00 €	● F016B33A012	741,00 €	● F016B43A012	741,00 €
● F016B23A018	741,00 €	● F016B33A018	741,00 €	● F016B43A018	741,00 €
● F016B23A030	741,00 €	● F016B33A030	741,00 €	● F016B43A030	741,00 €
● F016B23A033	741,00 €	● F016B33A033	741,00 €	● F016B43A033	741,00 €
1-10V		1-10V		1-10V	
○ F016B23B001	889,00 €	○ F016B33B001	889,00 €	○ F016B43B001	889,00 €
● F016B23B006	889,00 €	● F016B33B006	889,00 €	● F016B43B006	889,00 €
● F016B23B012	889,00 €	● F016B33B012	889,00 €	● F016B43B012	889,00 €
● F016B23B018	889,00 €	● F016B33B018	889,00 €	● F016B43B018	889,00 €
● F016B23B030	889,00 €	● F016B33B030	889,00 €	● F016B43B030	889,00 €
● F016B23B033	889,00 €	● F016B33B033	889,00 €	● F016B43B033	889,00 €
Dali		Dali		Dali	
○ F016B23D001	889,00 €	○ F016B33D001	889,00 €	○ F016B43D001	889,00 €
● F016B23D006	889,00 €	● F016B33D006	889,00 €	● F016B43D006	889,00 €
● F016B23D012	889,00 €	● F016B33D012	889,00 €	● F016B43D012	889,00 €
● F016B23D018	889,00 €	● F016B33D018	889,00 €	● F016B43D018	889,00 €
● F016B23D030	889,00 €	● F016B33D030	889,00 €	● F016B43D030	889,00 €
● F016B23D033	889,00 €	● F016B33D033	889,00 €	● F016B43D033	889,00 €

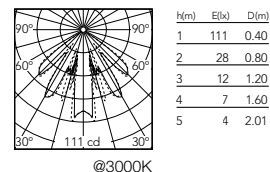

Caule: Accessoires / Accessories

Dispositif de protection contre les surtensions. 275Vac. Courant de décharge maximal 10KA (8/20us). Courant de fonctionnement maximal 5A. Adapté pour les connexions en séries. IP66.	Surge protection device. 275Vac. Maximum discharge current 10KA (8/20us). Maximum operating current 5A. Suitable for series connection. IP66.	F990E00A000	116,00 €
---	---	-------------	----------

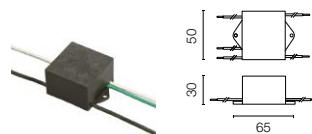

Boîtier pour installation au sol.	Box for ground installation.	F016Z000000	58,00 €
-----------------------------------	------------------------------	-------------	---------



Flauta

Designed by Patricia Urquiola





Flauta Spiga 3



Flauta Spiga 1

Famille / Family

Flauta Riga

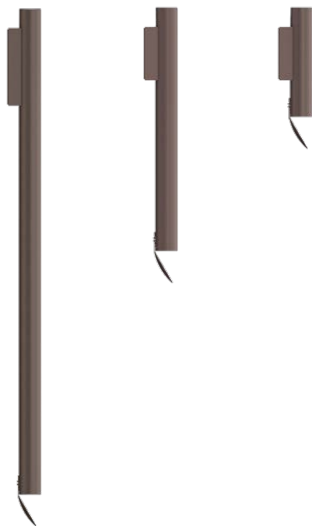

Power Led

12W

2x347 lm - 2700K/CRI 80

2x372 lm - 3000K/CRI 80

2x398 lm - 4000K/CRI 80

2200K available on request.

Flauta Spiga

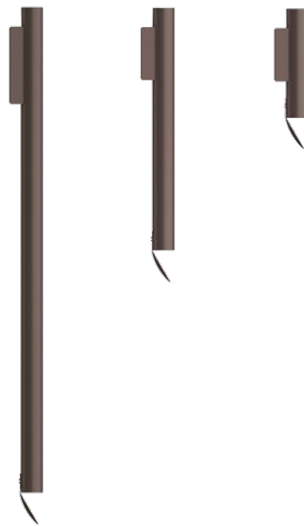

Power Led

12W

2x347 lm - 2700K/CRI 80

2x372 lm - 3000K/CRI 80

2x398 lm - 4000K/CRI 80

2200K available on request.

Finitions / Colours



01 White



06 Grey

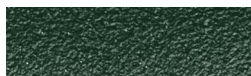

12 Forest Green



18 Deep Brown



30 Black



33 Anthracite

Description / Description

Collection d'appliques murales d'extérieur à bi-émission, disponible en trois longueurs.

Les luminaires se caractérisent par leur surface incisée déclinée en deux variantes raffinées : Flauta Riga, avec des incisions verticales, Flauta Spiga, caractérisée par une trame oblique élégante et sophistiquée.

Un déflecteur, peint dans la finition que le corps de la lampe, peut être installé sur la tête supérieure ou inférieure, pour créer un effet décoratif de lumière réfléchie. Les parties structurelles de l'appareil sont en aluminium traité par un procédé de conversion chimique afin de garantir une résistance efficace aux agents atmosphériques. Le corps est peint par poudres et disponible en différentes finitions selon la norme QUALICOAT. La première couche de poudre époxy confère une résistance chimique et mécanique, la deuxième couche de finition de poudre polyester offre une résistance aux rayons UV et aux agents atmosphériques corrosifs. Les surfaces peintes sont traitées par des lavages alcalins et acides, rincées à l'eau déminéralisée puis soumises à un traitement de conversion chimique pour les protéger de l'oxydation.

Diffuseur en verre transparent siliconé pour assurer l'étanchéité.

Source lumineuse LED intégrée. Driver intégré dans le corps de l'appareil pour un contrôle DALI dimmable.

Collection of outdoor wall-mounted light fittings with dual light emission, available in various lengths.

The units are characterised by the surface etching in two refined variations: Flauta Riga, with vertical lines, and Flauta Spiga, characterized by an elegant and sophisticated angular pattern.

Rounding out the device is a deflector accessory painted to match the finish of the lamp body. It can be installed as desired on the upper or lower head to create a decorative effect with reflected light.

The structure is made of aluminium treated with a chemical conversion process for effective resistance to atmospheric agents. The powder coating of the body is available in various finishes according to the QUALICOAT standard. The first layer of epoxy powder confers chemical and mechanical resistance. The second layer, a polyester powder finish, ensures resistance to UV rays and corrosive atmospheric agents. The painted surfaces are treated with alkali and acid washes, rinsed with demineralised water, and subjected to chemical conversion treatment to protect against rust. Diffuser in transparent glass, sealed to guarantee water resistance.

Integrated LED light source. Driver integrated in the body of the unit for DALI dimmer control.

Flauta Riga 1

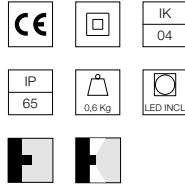
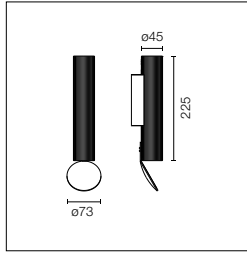

Source lumineuse LED comprise. Alimentation électrique 220-240V dimmable DALI intégrée. Déflecteur pour installation sur l'émission supérieure ou inférieure fourni. Version 110V sur demande.

LED light source included. Integrated 220-240V electrical power with DALI dimmer. Comes with deflector for optional installation on the upper or lower head. 110V version available by request.

2200K disponible sur demande.

2200K available on request.

Power Led: 12W - 2x555 lm ≠ FIXT 2x347 lm - 2700K/CRI 80 - 220-240V / 12W - 2x597 lm ≠ FIXT 2x372 lm - 3000K/CRI 80 - 220-240V / 12W - 2x638 lm ≠ FIXT 2x398 lm - 4000K/CRI 80 - 220-240V

2700K

○ F019A21D001	519,00 €
● F019A21D006	519,00 €
● F019A21D012	519,00 €
● F019A21D018	519,00 €
● F019A21D030	519,00 €
● F019A21D033	519,00 €

3000K

○ F019A31D001	519,00 €
● F019A31D006	519,00 €
● F019A31D012	519,00 €
● F019A31D018	519,00 €
● F019A31D030	519,00 €
● F019A31D033	519,00 €

4000K

○ F019A41D001	519,00 €
● F019A41D006	519,00 €
● F019A41D012	519,00 €
● F019A41D018	519,00 €
● F019A41D030	519,00 €
● F019A41D033	519,00 €

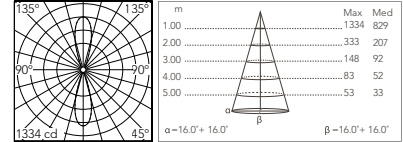

@3000K

Flauta Riga 2

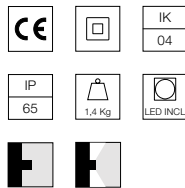
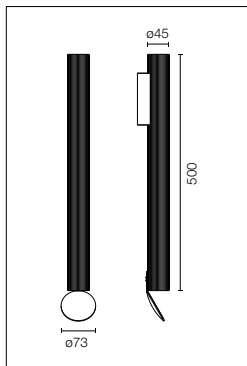

Source lumineuse LED comprise. Alimentation électrique 220-240V dimmable DALI intégrée. Déflecteur pour installation sur l'émission supérieure ou inférieure fourni. Version 110V sur demande.

LED light source included. Integrated 220-240V electrical power with DALI dimmer. Comes with deflector for optional installation on the upper or lower head. 110V version available by request.

2200K disponible sur demande.

2200K available on request.

Power Led: 12W - 2x555 lm ≠ FIXT 2x347 lm - 2700K/CRI 80 - 220-240V / 12W - 2x597 lm ≠ FIXT 2x372 lm - 3000K/CRI 80 - 220-240V / 12W - 2x638 lm ≠ FIXT 2x398 lm - 4000K/CRI 80 - 220-240V

2700K

○ F019A22D001	610,00 €
● F019A22D006	610,00 €
● F019A22D012	610,00 €
● F019A22D018	610,00 €
● F019A22D030	610,00 €
● F019A22D033	610,00 €

3000K

○ F019A32D001	610,00 €
● F019A32D006	610,00 €
● F019A32D012	610,00 €
● F019A32D018	610,00 €
● F019A32D030	610,00 €
● F019A32D033	610,00 €

4000K

○ F019A42D001	610,00 €
● F019A42D006	610,00 €
● F019A42D012	610,00 €
● F019A42D018	610,00 €
● F019A42D030	610,00 €
● F019A42D033	610,00 €

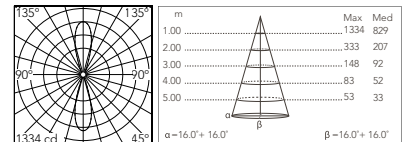

@3000K

Flauta Spiga 1

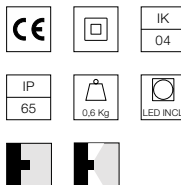
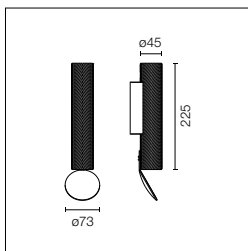

Source lumineuse LED comprise. Alimentation électrique 220-240V dimmable DALI intégrée. Déflecteur pour installation sur l'émission supérieure ou inférieure fourni. Version 110V sur demande.

LED light source included. Integrated 220-240V electrical power with DALI dimmer. Comes with deflector for optional installation on the upper or lower head. 110V version available by request.

2200K disponible sur demande.

2200K available on request.

Power Led: 12W - 2x555 lm ≠ FIXT 2x347 lm - 2700K/CRI 80 - 220-240V / 12W - 2x597 lm ≠ FIXT 2x372 lm - 3000K/CRI 80 - 220-240V / 12W - 2x638 lm ≠ FIXT 2x398 lm - 4000K/CRI 80 - 220-240V

2700K		3000K		4000K	
○ F019B21D001	600,00 €	○ F019B31D001	600,00 €	○ F019B41D001	600,00 €
● F019B21D006	600,00 €	● F019B31D006	600,00 €	● F019B41D006	600,00 €
● F019B21D012	600,00 €	● F019B31D012	600,00 €	● F019B41D012	600,00 €
● F019B21D018	600,00 €	● F019B31D018	600,00 €	● F019B41D018	600,00 €
● F019B21D030	600,00 €	● F019B31D030	600,00 €	● F019B41D030	600,00 €
● F019B21D033	600,00 €	● F019B31D033	600,00 €	● F019B41D033	600,00 €

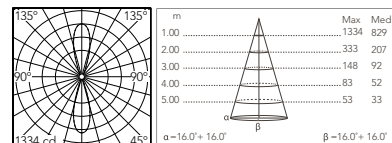

@3000K

Flauta Spiga 2

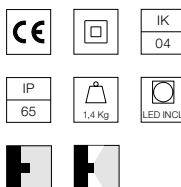
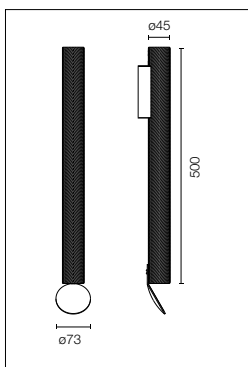

Source lumineuse LED comprise. Alimentation électrique 220-240V dimmable DALI intégrée. Déflecteur pour installation sur l'émission supérieure ou inférieure fourni. Version 110V sur demande.

LED light source included. Integrated 220-240V electrical power with DALI dimmer. Comes with deflector for optional installation on the upper or lower head. 110V version available by request.

2200K disponible sur demande.

2200K available on request.

Power Led: 12W - 2x555 lm ≠ FIXT 2x347 lm - 2700K/CRI 80 - 220-240V / 12W - 2x597 lm ≠ FIXT 2x372 lm - 3000K/CRI 80 - 220-240V / 12W - 2x638 lm ≠ FIXT 2x398 lm - 4000K/CRI 80 - 220-240V

2700K		3000K		4000K	
○ F019B22D001	773,00 €	○ F019B32D001	773,00 €	○ F019B42D001	773,00 €
● F019B22D006	773,00 €	● F019B32D006	773,00 €	● F019B42D006	773,00 €
● F019B22D012	773,00 €	● F019B32D012	773,00 €	● F019B42D012	773,00 €
● F019B22D018	773,00 €	● F019B32D018	773,00 €	● F019B42D018	773,00 €
● F019B22D030	773,00 €	● F019B32D030	773,00 €	● F019B42D030	773,00 €
● F019B22D033	773,00 €	● F019B32D033	773,00 €	● F019B42D033	773,00 €

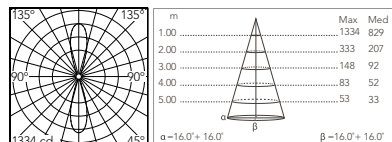

@3000K

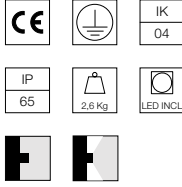
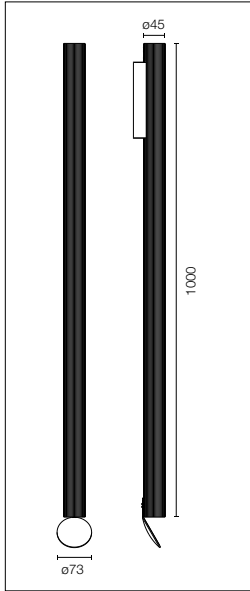

Source lumineuse LED comprise. Alimentation électrique 220-240V dimmable DALI intégrée. Déflecteur pour installation sur l'émission supérieure ou inférieure fourni. Version 110V sur demande.

LED light source included. Integrated 220-240V electrical power with DALI dimmer. Comes with deflector for optional installation on the upper or lower head. 110V version available by request.

2200K disponible sur demande.

2200K available on request.

Power Led: 12W - 2x555 lm ≠ FIXT 2x347 lm - 2700K/CRI 80 - 220-240V / 12W - 2x597 lm ≠ FIXT 2x372 lm - 3000K/CRI 80 - 220-240V / 12W - 2x638 lm ≠ FIXT 2x398 lm - 4000K/CRI 80 - 220-240V

2700K

- F019A23D001 860,00 €
- F019A23D006 860,00 €
- F019A23D012 860,00 €
- F019A23D018 860,00 €
- F019A23D030 860,00 €
- F019A23D033 860,00 €

3000K

- F019A33D001 860,00 €
- F019A33D006 860,00 €
- F019A33D012 860,00 €
- F019A33D018 860,00 €
- F019A33D030 860,00 €
- F019A33D033 860,00 €

4000K

- F019A43D001 860,00 €
- F019A43D006 860,00 €
- F019A43D012 860,00 €
- F019A43D018 860,00 €
- F019A43D030 860,00 €
- F019A43D033 860,00 €

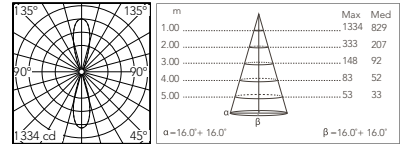

@3000K

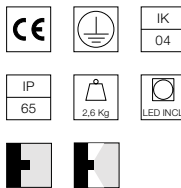
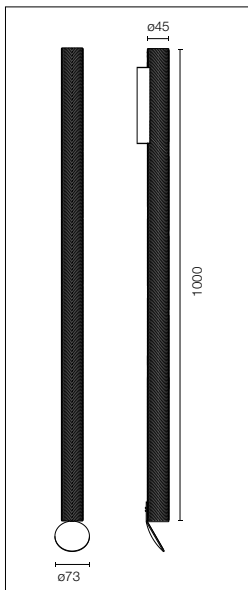

Source lumineuse LED comprise. Alimentation électrique 220-240V dimmable DALI intégrée. Déflecteur pour installation sur l'émission supérieure ou inférieure fourni. Version 110V sur demande.

LED light source included. Integrated 220-240V electrical power with DALI dimmer. Comes with deflector for optional installation on the upper or lower head. 110V version available by request.

2200K disponible sur demande.

2200K available on request.

Power Led: 12W - 2x555 lm ≠ FIXT 2x347 lm - 2700K/CRI 80 - 220-240V / 12W - 2x597 lm ≠ FIXT 2x372 lm - 3000K/CRI 80 - 220-240V / 12W - 2x638 lm ≠ FIXT 2x398 lm - 4000K/CRI 80 - 220-240V

2700K

- F019B23D001 1.156,00 €
- F019B23D006 1.156,00 €
- F019B23D012 1.156,00 €
- F019B23D018 1.156,00 €
- F019B23D030 1.156,00 €
- F019B23D033 1.156,00 €

3000K

- F019B33D001 1.156,00 €
- F019B33D006 1.156,00 €
- F019B33D012 1.156,00 €
- F019B33D018 1.156,00 €
- F019B33D030 1.156,00 €
- F019B33D033 1.156,00 €

4000K

- F019B43D001 1.156,00 €
- F019B43D006 1.156,00 €
- F019B43D012 1.156,00 €
- F019B43D018 1.156,00 €
- F019B43D030 1.156,00 €
- F019B43D033 1.156,00 €

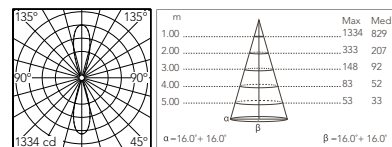

@3000K

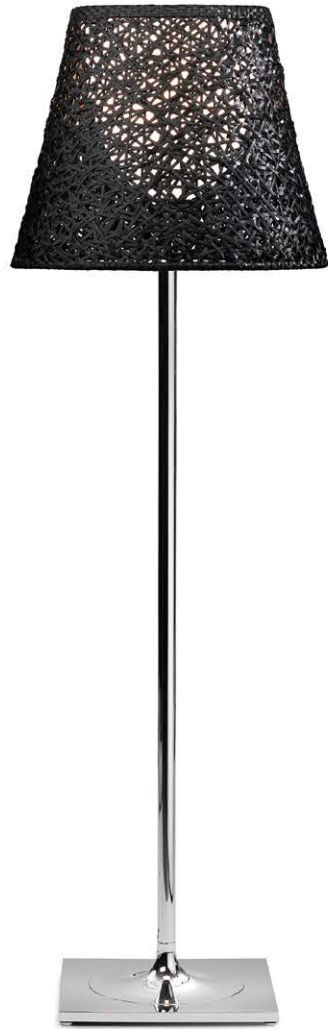

Lighting in the Rain

Designed by Philippe Starck





Superarchimoon



Romeo Suspension



Romeo Floor

Famille / Family

Lighting in the Rain



HSGS E27

250W

or

Led

21W

2450 lm - 3000K/CRI 80

Finitions / Colours

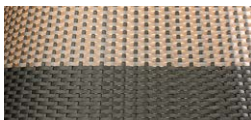

22 Panama



41 Green Wall

KTribe F3 Outdoor

Lampadaire à lumière diffuse pour l'extérieur. Base et support de bras en fonte d'aluminium, bras en aluminium extrudé.

Les parties structurelles de l'appareil ont subi un traitement de conversion chimique offrant une meilleure résistance aux agents atmosphériques. Finition chromée. Diffuseur intérieur et support de douille en polycarbonate moulé par injection. Diffuseur externe en fils de PVC tressés de différentes couleurs, structure intérieure en fil d'aluminium recouvert d'une peinture polyester. Contrepoids en acier traité par cataphorèse, garantissant une meilleure résistance aux agents atmosphériques. Cache du diffuseur externe en fonte d'aluminium.

Romeo C3 Outdoor

Lampe d'extérieur pour installation au plafond, à lumière directe et diffuse. Diffuseur externe en fils de PVC colorés tressés, sur un cadre interne en tubulaire d'aluminium recouvert d'une peinture polyester. Diffuseur interne en polycarbonate thermoformé sous vide de couleur opale et qui peut être facilement retiré par l'utilisateur pour le remplacement de la lampe, sans nécessité d'outils spécifiques. Support diffuseur en alliage d'aluminium moulé sous pression, anodisé et recouvert d'une peinture liquide de couleur grise. Attache plafond en alliage d'aluminium moulé sous pression avec finition brillante.

Rosace de couverture en polycarbonate (PC) moulé par injection. Tige en acier INOX alliage 316L – poli. Afin d'assurer une bonne résistance aux agents atmosphériques, toutes les pièces peintes sont traitées avec un procédé de conversion chimique anticorrosion.

Superarchimoon Outdoor

Lampadaire d'extérieur à lumière directe et diffuse. Diffuseur externe en fils de PVC colorés tressés sur cadre interne en tubulaire d'aluminium recouvert d'une peinture polyester. Diffuseur interne en polycarbonate opalin moulé par injection. Les différents éléments structurels de la lampe (base, support diffuseur, bras, fourches, leviers et tirants) sont traités avec un procédé de conversion chimique afin d'assurer une bonne résistance aux agents atmosphériques. Le corps est recouvert d'une peinture de couleur grise. Les ressorts et les principaux composants mécaniques de la lampe sont réalisés dans des matériaux spécifiques afin de garantir leur bonne résistance aux agents atmosphériques.

La lampe n'est pas équipée de fonction ON/OFF ni de variateur mais d'un câble d'alimentation bipolaire transparent d'une longueur utile de 10 mètres. La lampe est également équipée d'une boîte de dérivation pour un câblage adapté aux utilisations en extérieur.

Il est recommandé d'utiliser un système de connexion présentant un degré de protection supérieur ou égal au degré de protection de l'appareil.

KTribe F3 Outdoor

Floor lamp emitting diffused light for outdoor use. Die-cast aluminum base and pole support. Chemical conversion treatment of the structural parts to enhance their resistance to atmospheric agents. Chrome finish. Injection-molded polycarbonate internal diffuser and bulb-holder. External diffuser made from braided colored PVC tubes and inner frame from polyester-painted aluminum tubes. Steel cataphoresis treated counterweight for effective weather resistance. Painted die-cast aluminum external diffuser cover.

Romeo C3 Outdoor

Suspension luminaire for outdoor use providing direct and diffused light. External diffuser obtained from braided colored PVC tubes, internal frame in polyester-painted aluminum tubes. Inner diffuser in opal-colored, vacuum-formed polycarbonate which is removable for bulb change without the use of tools. Diffuser support in anodized die-cast aluminum alloy, liquid grey painted. Die-cast aluminum alloy ceiling fitting with polished finish. Injection-molded polycarbonate (PC) cover rose. 316L stainless steel pole – polished.

In order to obtain good weather resistance, all the painted details have undergone a chemical conversion treatment for enhanced corrosion resistance.

Superarchimoon Outdoor

Floor lamp for outdoor use providing direct and diffused light. External diffuser obtained from braided colored PVC tubes, internal frame in polyester-painted aluminum tubular. Internal diffuser in injection-molded opal polycarbonate. The structural parts of the luminaire (base support, diffusers support, arms, brackets, levers and tie rods) have been treated with a chemical conversion for enhanced weather resistance. The body is painted in grey. Springs and main mechanical components are also made with special materials for good weather resistance.

The luminaire has no ON/OFF switch or luminous flux adjustment, but has a 10 mt transparent bipolar feeding cord. The luminaire also is equipped with a junction box suitable for outdoor applications.

We recommend using a connection system with a higher or equal protection degree than the one of the luminaire.

Romeo Outdoor C3 Pvc 710 mm

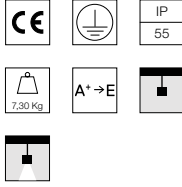
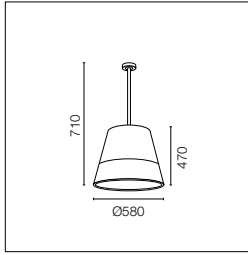

Source non comprise.

Light source not included.

HSGS E27: 1x250W or **1 LED:** 21W - 2450 lm - 3000K

- F6468022 1.604,00 €
- F6468041 1.604,00 €

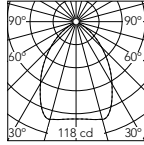

Beam Angle: 78°

h(m)	E(lx)	D(m)
1	118	1.63
2	30	3.26
3	13	4.89
4	7	6.53
5	5	8.16

Panama

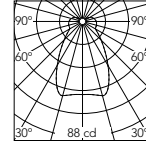

Beam Angle: 74°

h(m)	E(lx)	D(m)
1	88	1.50
2	22	3.01
3	10	4.51
4	6	6.02
5	4	7.52

Green Wall

Accessoires / Accessories

1 x LED 21W E27 2450lm 3000K cod. RF26998 [e] DIMMER 32,00 €

Romeo Outdoor C3 Pvc 910 mm

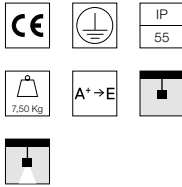
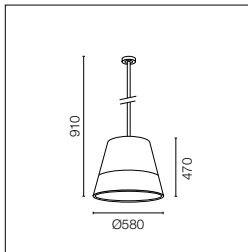

Source non comprise.

Light source not included.

HSGS E27: 1x250W or **1 LED:** 21W - 2450 lm - 3000K

- F6469022 1.604,00 €
- F6469041 1.604,00 €

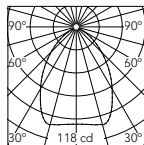

Beam Angle: 78°

h(m)	E(lx)	D(m)
1	118	1.63
2	30	3.26
3	13	4.89
4	7	6.53
5	5	8.16

Panama

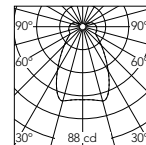

Beam Angle: 74°

h(m)	E(lx)	D(m)
1	88	1.50
2	22	3.01
3	10	4.51
4	6	6.02
5	4	7.52

Green Wall

Accessoires / Accessories

1 x LED 21W E27 2450lm 3000K cod. RF26998 [e] DIMMER 32,00 €

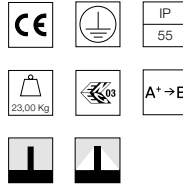
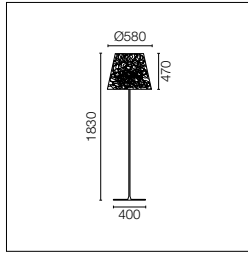

Source non comprise.

Light source not included.

HSGS E27: 1x250W or **1 LED:** 21W - 2450 lm - 3000K Dimming

- F6268022 1.740,00 €
- F6268041 1.740,00 €

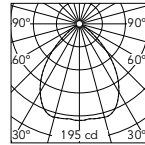

Beam Angle: 85°

h(m)	E(lx)	D(m)
1	195	1.82
2	49	3.64
3	22	5.46
4	12	7.28
5	8	9.10

Panama

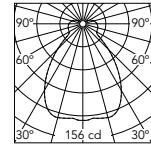

Beam Angle: 82°

h(m)	E(lx)	D(m)
1	156	1.74
2	39	3.49
3	17	5.23
4	10	6.98
5	6	8.72

Green Wall

Accessoires / Accessories

1 x LED 21W E27 2450lm 3000K cod. RF26998 [e] DIMMER 32,00 €

Superarchimoon Outdoor

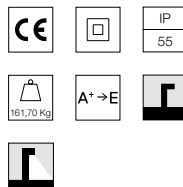
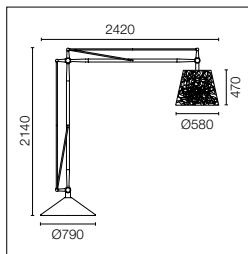

Source non comprise.

Light source not included.

HSGS E27: 1x250W or **1 LED:** 21W - 2450 lm - 3000K

- F6367022 8.743,00 €
- F6367041 8.743,00 €

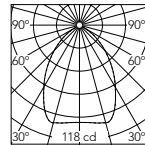

Beam Angle: 78°

h(m)	E(lx)	D(m)
1	118	1.63
2	30	3.26
3	13	4.89
4	7	6.53
5	5	8.16

Panama

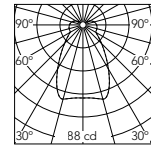

Beam Angle: 74°

h(m)	E(lx)	D(m)
1	88	1.50
2	22	3.01
3	10	4.51
4	6	6.02
5	4	7.52

Green Wall

Accessoires / Accessories

1 x LED 21W E27 2450lm 3000K cod. RF26998 [e] DIMMER 32,00 €

Landlord

Designed by Piero Lissoni





Landlord Ground



Landlord Soft



Landlord Spot + Pole

Famille / Family

Landlord Spot



Landlord Spot + Pole



Landlord Soft



Landlord Ground



Power Led

2,3W
130 lm - 2700K/CRI 80
135 lm - 3000K/CRI 80
140 lm - 4000K/CRI 80
[2200K available on request.](#)

Power Led

3,4W
135 lm - 2700K/CRI 80
140 lm - 3000K/CRI 80
145 lm - 4000K/CRI 80
[2200K available on request.](#)

Power Led

5W
242 lm - 2700K/CRI 80
252 lm - 3000K/CRI 80
269 lm - 4000K/CRI 80
[2200K available on request.](#)

Power Led

2,3W
121 lm - 2700K/CRI 80
125 lm - 3000K/CRI 80
130 lm - 4000K/CRI 80
[2200K available on request.](#)

Power Led

7,2W
442 lm - 2700K/CRI 80
457 lm - 3000K/CRI 80
492 lm - 4000K/CRI 80

Power Led

3,4W
183 lm - 2700K/CRI 80
189 lm - 3000K/CRI 80
196 lm - 4000K/CRI 80
[2200K available on request.](#)

Finitions / Colours

Landlord Spot / Soft



01 White



06 Grey

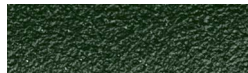

12 Forest Green



18 Deep Brown



30 Black



33 Anthracite



71 Anodized Black

Landlord Ground

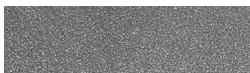

56 Matt Stainless Steel

Landlord Spot

Projecteur IP66 pour l'extérieur avec corps en aluminium tourné alimenté en 24V, disponible en 2700K, 3000K et 4000K. Sur l'axe horizontal, le projecteur peut être orienté de 359°, sur l'axe vertical jusqu'à 30° vers le bas et jusqu'à 90° vers le haut.

Les spots Landlord sont disponibles en deux tailles, tête ø40 et ø50, toutes deux équipées d'une virole frontale démontable pour permettre l'installation de lentille flood ou jusqu'à deux "honeycomb" pour un confort visuel optimal.

Les spots Landlord peuvent être installés sur piquets pour sols durs avec possibilité de piquet en option, sur une base murale, ou sur une ceinture innovante conçue pour fixer les luminaires directement sur les branches des arbres.

Landlord Soft

Projecteur IP65 pour l'extérieur conçu pour offrir un lumière diffuse.

Il se caractérise par une tête en forme de disque en aluminium, orientable jusqu'à 20° et position verrouillable, alimenté en 24V et disponible en 2700K, 3000K et 4000K.

C'est le produit parfait pour éclairer les buissons et les circulations avec un faisceau de lumière homogène.

Landlord Soft peut être installé sur piquets pour sols durs avec possibilité de piquet en option.

Landlord Ground

Luminaires IP66 / IP67 pour montage encastré au sol, alimentés en 24V. Corps en aluminium anodisé puis résiné, anneau externe en acier inoxydable grenailé, enfermant le bloc de commande électronique. Tête disponible en deux tailles, ø49 mm et ø64 mm, à émission frontale ou rasante (un, deux ou quatre faisceaux).

La version à émission frontale est disponible avec optique spot ou médium, ou avec honeycomb intégré non amovible, pour un confort visuel optimal.

A installer dans son boîtier d'installation.

Landlord Spot

IP66 projector for external use made of turned aluminium body and powered at 24V, and available in 2700K, 3000K and 4000K colour temperatures. With reference to the horizontal axis the spotlight can be swivelled by 359°, on the vertical axis by up to 30° down and up to 90° up.

Landlord Spots are available in two sizes, ø40 and ø50 head, both equipped with desmontable front ferrule, in order to install flood lens or up to two honeycombs for maximum visual confort.

Landlord Spots can be installed on solid ground spikes, with the possibility of an optional picket, on wall base, or on the innovative tree belt, designed to fix the luminaires directly on tree branches.

Landlord Soft

IP65 projector for external use, designed to offer diffuse lighting.

It is characterized by an aluminium disk shape head, orientable up to 20° beam and lockable in position, to be powered at 24V, and available in 2700K, 3000K and 4000K colour temperature.

It is the perfect tool to light bushes, flowerbed and transit areas with an homogenous diffuse light beam.

Landlord Soft can be installed on solid ground spikes, with the possibility of an optional picket.

Landlord Ground

IP66 / IP67 luminaires for ground recessed installation, powered 24V. Body in anodized, then resined aluminium, external ring in shot-peened stainless steel, encasing the entire control electronics. Head available in two sizes, ø49 mm, and ø64 mm, with frontal or grazing emission (one, two or four beams).

Frontal emission version are available with spot or medium optic, or with integrated non removable honeycomb, for maximum visual confort.

To be installed in its installation box.

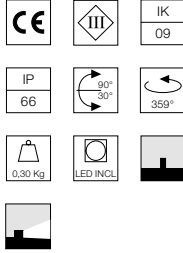
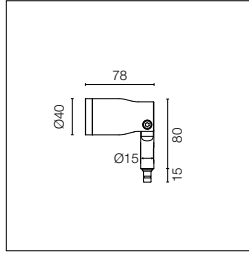

Tête orientable pour installation sur mât de sol ou sur base murale. Les mâts et les bases sont des accessoires à commander séparément. Les têtes sont équipées d'une virole démontable pour permettre d'insérer des lentilles flood ou jusqu'à deux "honeycomb" (à commander séparément). Chaque tête est fournie avec un segment de câble sortant de 2000 mm et un kit de câblage.

Spot adjustable head for installation on ground poles or on wall base. Poles and base to be ordered as separated accessories. Heads are equipped with a dismantlable ferrule, to insert flood lens or up to two honeycombs, (to be ordered as separate accessories). 24V remote power supply to be ordered separately. Each head comes with a 2000 mm lenght outgoing cable and a wiring kit.

2200K disponible sur demande.

2200K available on request.

Optic Spot 12°

Power Led: 2,3W - 188 lm ≠ *FIXT 130 lm - 2700K/CRI 80 - 24V / 2,3W - 195 lm ≠ *FIXT 135 lm - 3000K/CRI 80 - 24V / 2,3W - 202 lm ≠ *FIXT 140 lm - 4000K/CRI 80 - 24V

2700K

PWM Dimmable

- F004D21A001 271,00 €
- F004D21A006 271,00 €
- F004D21A012 271,00 €
- F004D21A018 271,00 €
- F004D21A030 271,00 €
- F004D21A033 271,00 €
- F004F21A071 325,00 €

3000K

PWM Dimmable

- F004D31A001 271,00 €
- F004D31A006 271,00 €
- F004D31A012 271,00 €
- F004D31A018 271,00 €
- F004D31A030 271,00 €
- F004D31A033 271,00 €
- F004F31A071 325,00 €

4000K

PWM Dimmable

- F004D41A001 271,00 €
- F004D41A006 271,00 €
- F004D41A012 271,00 €
- F004D41A018 271,00 €
- F004D41A030 271,00 €
- F004D41A033 271,00 €
- F004F41A071 325,00 €

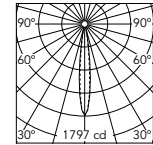

Beam Angle: 12°

h(m)	E(lx)	D(m)
1	1797	0.24
2	449	0.48
3	200	0.72
4	112	0.97
5	72	1.21

@4000K

Optic Medium 34°

Power Led: 2,3W - 188 lm ≠ *FIXT 122 lm - 2700K/CRI 80 - 24V / 2,3W - 195 lm ≠ *FIXT 127 lm - 3000K/CRI 80 - 24V / 2,3W - 202 lm ≠ *FIXT 131lm - 4000K/CRI 80 - 24V

2700K

PWM Dimmable

- F004D22A001 271,00 €
- F004D22A006 271,00 €
- F004D22A012 271,00 €
- F004D22A018 271,00 €
- F004D22A030 271,00 €
- F004D22A033 271,00 €
- F004F22A071 325,00 €

3000K

PWM Dimmable

- F004D32A001 271,00 €
- F004D32A006 271,00 €
- F004D32A012 271,00 €
- F004D32A018 271,00 €
- F004D32A030 271,00 €
- F004D32A033 271,00 €
- F004F32A071 325,00 €

4000K

- F004D42A001 271,00 €
- F004D42A006 271,00 €
- F004D42A012 271,00 €
- F004D42A018 271,00 €
- F004D42A030 271,00 €
- F004D42A033 271,00 €
- F004F42A071 325,00 €

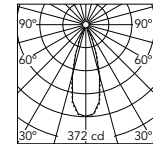

Beam Angle: 34°

h(m)	E(lx)	D(m)
1	372	0.59
2	93	1.18
3	41	1.77
4	23	2.36
5	15	2.95

@4000K

* Nombre maximum de luminaires par source d'alimentation / Maximum number of luminaires per power supply.

Nombre maximum de luminaires par source d'alimentation (220-240 V). Ces données doivent être vérifiées en prenant en compte les conditions spécifiques d'installation.

Maximum number of luminaires per power supply. (220-240 V). These data must be checked taking into account the specific installation conditions.

Non Dimmable

Acc. RF25754	3
Acc. RF25748	3
Acc. RF25747	4
Acc. RF25757	4
Acc. F990B23AZ00	12
Acc. F990B28A000	17
Acc. F990B27A000	27

Dimmable

Acc. F990B02A000	13
Acc. F990B03A000	13
Acc. F990B16A000	13
Acc. F990B04A000	28
Acc. F990B05A000	28
Acc. F990B17A000	28

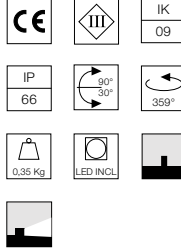
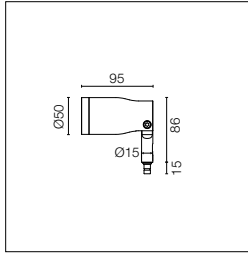

Tête orientable pour installation sur mât de sol ou sur base murale. Les mâts et les bases sont des accessoires à commander séparément. Les têtes sont équipées d'une virole démontable pour permettre d'insérer des lentilles flood ou jusqu'à deux "honeycomb" (à commander séparément). Chaque tête est fournie avec un segment de câble sortant de 2000 mm et un kit de câblage.

Spot adjustable head for installation on ground poles or on wall base. Poles and base to be ordered as separated accessories. Heads are equipped with a dismantlable ferrule, to insert flood lens or up to two honeycombs, (to be ordered as separate accessories). 24V remote power supply to be ordered separately. Each head comes with a 2000 mm lenght outgoing cable and a wiring kit.

Optic Narrow Spot
2200K disponible sur demande.

Optic Narrow Spot
2200K available on request.

Optic Narrow Spot 7°

Power Led: 3,4W - 251 lm ≠ FIXT 135 lm - 2700K/CRI 80 - 24V / 3,4W - 260 lm ≠ FIXT 140 lm - 3000K/CRI 80 - 24V / 3,4W - 270 lm ≠ FIXT 145 lm - 4000K/CRI 80 - 24V

2700K		3000K		4000K	
PWM Dimmable		PWM Dimmable		PWM Dimmable	
○ F004E21A001	295,00 €	○ F004E31A001	295,00 €	○ F004E41A001	295,00 €
● F004E21A006	295,00 €	● F004E31A006	295,00 €	● F004E41A006	295,00 €
● F004E21A012	295,00 €	● F004E31A012	295,00 €	● F004E41A012	295,00 €
● F004E21A018	295,00 €	● F004E31A018	295,00 €	● F004E41A018	295,00 €
● F004E21A030	295,00 €	● F004E31A030	295,00 €	● F004E41A030	295,00 €
● F004E21A033	295,00 €	● F004E31A033	295,00 €	● F004E41A033	295,00 €
● F004G21A071	351,00 €	● F004G31A071	351,00 €	● F004G41A071	351,00 €

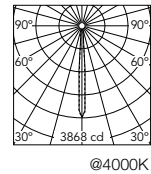

Beam Angle: 7°

h(m)	Ef(x)	D(m)
1	3868	0.14
2	967	0.28
3	430	0.41
4	242	0.55
5	155	0.69

@4000K

* Nombre maximum de luminaires par source d'alimentation / Maximum number of luminaires per power supply.

Nombre maximum de luminaires par source d'alimentation (220-240 V). Ces données doivent être vérifiées en prenant en compte les conditions spécifiques d'installation.	Maximum number of luminaires per power supply. (220-240 V). These data must be checked taking into account the specific installation conditions.	Non Dimmable	Dimmable		
		Acc. RF25754	1	Acc. F990B02A000	7
		Acc. RF25748	1	Acc. F990B03A000	7
		Acc. RF25747	3	Acc. F990B16A000	7
		Acc. RF25757	3	Acc. F990B04A000	17
		Acc. F990B23AZ00	7	Acc. F990B05A000	17
		Acc. F990B28A000	9	Acc. F990B17A000	17
		Acc. F990B27A000	17		

Optic Medium 24°

Power Led: 7,2W - 666 lm ≠ FIXT 442 lm - 2700K/CRI 80 - 24V / 7,2W - 689 lm ≠ FIXT 457 lm - 3000K/CRI 80 - 24V / 7,2W - 741 lm ≠ FIXT 492 lm - 4000K/CRI 80 - 24V

2700K		3000K		4000K	
PWM Dimmable		PWM Dimmable		PWM Dimmable	
○ F004E22A001.A	295,00 €	○ F004E32A001.A	295,00 €	○ F004E42A001	295,00 €
● F004E22A006.A	295,00 €	● F004E32A006.A	295,00 €	● F004E42A006	295,00 €
● F004E22A012.A	295,00 €	● F004E32A012.A	295,00 €	● F004E42A012	295,00 €
● F004E22A018.A	295,00 €	● F004E32A018.A	295,00 €	● F004E42A018	295,00 €
● F004E22A030.A	295,00 €	● F004E32A030.A	295,00 €	● F004E42A030	295,00 €
● F004E22A033.A	295,00 €	● F004E32A033.A	295,00 €	● F004E42A033	295,00 €
● F004G22A071.A	351,00 €	● F004G32A071.A	351,00 €	● F004G42A071	351,00 €

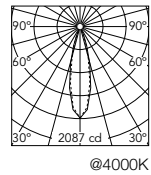

Beam Angle: 24°

h(m)	Ef(x)	D(m)
1	2087	0.47
2	522	0.94
3	232	1.41
4	130	1.88
5	83	2.35

@4000K

* Nombre maximum de luminaires par source d'alimentation / Maximum number of luminaires per power supply.

Nombre maximum de luminaires par source d'alimentation (220-240 V). Ces données doivent être vérifiées en prenant en compte les conditions spécifiques d'installation.	Maximum number of luminaires per power supply. (220-240 V). These data must be checked taking into account the specific installation conditions.	Non Dimmable	Dimmable		
		Acc. RF25754	1	Acc. F990B02A000	3
		Acc. RF25748	1	Acc. F990B03A000	3
		Acc. RF25747	1	Acc. F990B16A000	3
		Acc. RF25757	1	Acc. F990B04A000	7
		Acc. F990B23AZ00	3	Acc. F990B05A000	7
		Acc. F990B28A000	6	Acc. F990B17A000	7
		Acc. F990B27A000	9		

Landlord Spot: Tête + mât accessoire / Head + pole accessory

Spot Ø40

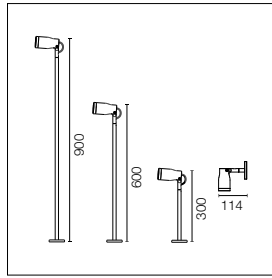

Mat avec base.
Prévu pour installation sur surface solide.
Pour installation au sol, compléter avec mât de sol, à commander séparément.

Pole with base.
Ready for installation on solid surface.
Ground installation needs earth stick use, to be ordered as separated item.

H 300 mm

- F004Z010001 61,00 €
- F004Z010006 61,00 €
- F004Z010012 61,00 €
- F004Z010018 61,00 €
- F004Z010030 61,00 €
- F004Z010033 61,00 €
- F004Z0D0071 66,00 €

H 600 mm

- F004Z020001 67,00 €
- F004Z020006 67,00 €
- F004Z020012 67,00 €
- F004Z020018 67,00 €
- F004Z020030 67,00 €
- F004Z020033 67,00 €
- F004Z0E0071 74,00 €

H 900 mm

- F004Z030001 78,00 €
- F004Z030006 78,00 €
- F004Z030012 78,00 €
- F004Z030018 78,00 €
- F004Z030030 78,00 €
- F004Z030033 78,00 €
- F004Z0F0071 91,00 €



Spot Ø50

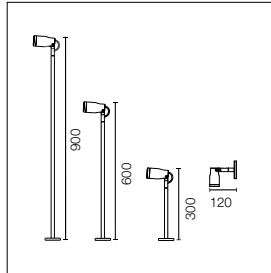

Landlord Spot: Accessoires / Accessories

Base murale.

Wall base.

- F004Z040001 56,00 €
- F004Z040006 56,00 €
- F004Z040012 56,00 €
- F004Z040018 56,00 €
- F004Z040030 56,00 €
- F004Z040033 56,00 €
- F004Z0A0071 66,00 €



Mât de sol.
Pour montage sur mât avec base.

Earth stick.
To be mounted on poles with base.

- F004Z060000 21,00 €



Honeycomb.

Honeycomb.

- Landlord Spot Ø40
- F004Z0B0000 18,00 €
- Landlord Spot Ø50
- F004Z0L0000 23,00 €



Lentille flood.

Flood lens.

- Landlord Spot Ø40
- F004Z0C0000 18,00 €
- Landlord Spot Ø50
- F004Z0H0000 23,00 €



Bracelet d'arbre.
Accessoire pour installer le spot directement sur branche d'arbre, de ø30 mm à ø100 mm.
Finition Deep Brown

Tree strap.
Accessory for spot installation directly on tree branch, from ø30mm up to ø100mm.
Deep Brown finishing.

- F004Z070000 128,00 €



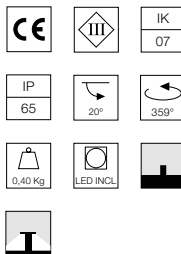
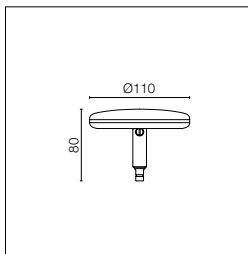

Tête orientable à 20° pour installation sur mâts au sol. Les mâts sont des accessoires à commander séparément. Alimentation à distance 24V à commander séparément. Chaque tête est livrée avec un segment de câble sortant de 2000 mm et un kit de câblage.

20° adjustable head for installation on ground poles. Poles to be ordered as separated accessories. 24V remote power supply to be ordered separately. Each head comes with a 2000 mm lenght outgoing cable and a wiring kit.

2200K disponible sur demande.

2200K available on request.

Top Led: 5W - 379 lm ≠ FIXT 242 lm - 2700K/CRI 80 - 24V / 5W - 395 lm ≠ FIXT 252 lm - 3000K/CRI 80 - 24V / 5W - 421 lm ≠ FIXT 269 lm - 4000K/CRI 80 - 24V

2700K

PWM Dimmable

- F004C20A001 401,00 €
- F004C20A006 401,00 €
- F004C20A012 401,00 €
- F004C20A018 401,00 €
- F004C20A030 401,00 €
- F004C20A033 401,00 €
- F004H20A071 464,00 €

3000K

PWM Dimmable

- F004C30A001 401,00 €
- F004C30A006 401,00 €
- F004C30A012 401,00 €
- F004C30A018 401,00 €
- F004C30A030 401,00 €
- F004C30A033 401,00 €
- F004H30A071 464,00 €

4000K

PWM Dimmable

- F004C40A001 401,00 €
- F004C40A006 401,00 €
- F004C40A012 401,00 €
- F004C40A018 401,00 €
- F004C40A030 401,00 €
- F004C40A033 401,00 €
- F004H40A071 464,00 €

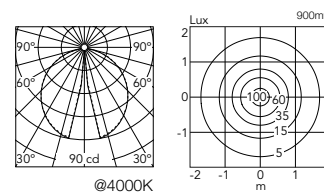
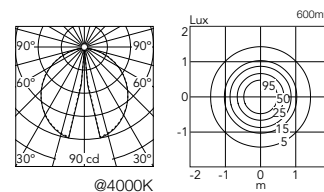
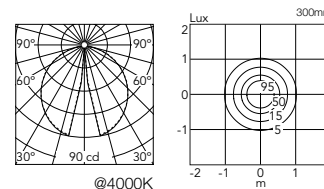

* Nombre maximum de luminaires par source d'alimentation / Maximum number of luminaires per power supply.

Nombre maximum de luminaires par source d'alimentation (220-240 V). Ces données doivent être vérifiées en prenant en compte les conditions spécifiques d'installation.

Maximum number of luminaires per power supply. (220-240 V). These data must be checked taking into account the specific installation conditions.

Non Dimmable		Dimmable	
Acc. RF25754	1	Acc. RF26387.A	3
Acc. RF25748	1	Acc. F990B02A000	5
Acc. RF25747	1	Acc. F990B03A000	5
Acc. RF25757	1	Acc. F990B16A000	5
Acc. F990B23AZ00	3	Acc. F990B04A000	12
Acc. F990B28A000	6	Acc. F990B05A000	12
Acc. F990B27A000	9	Acc. F990B17A000	12

Landlord Soft: Tête + mât accessoire / Head + pole accessory

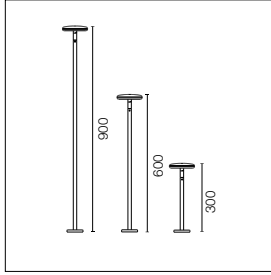

Mat avec base.
Prévu pour installation sur surface solide.
Pour installation au sol, compléter avec mât de sol, à commander séparément.

Pole with base.
Ready for installation on solid surface.
Ground installation needs earth stick use, to be ordered as separated item.



H 300 mm

○ F004Z010001	61,00 €
● F004Z010006	61,00 €
● F004Z010012	61,00 €
● F004Z010018	61,00 €
● F004Z010030	61,00 €
● F004Z010033	61,00 €
● F004Z0D0071	66,00 €

H 600 mm

○ F004Z020001	67,00 €
● F004Z020006	67,00 €
● F004Z020012	67,00 €
● F004Z020018	67,00 €
● F004Z020030	67,00 €
● F004Z020033	67,00 €
● F004Z0E0071	74,00 €

H 900 mm

○ F004Z030001	78,00 €
● F004Z030006	78,00 €
● F004Z030012	78,00 €
● F004Z030018	78,00 €
● F004Z030030	78,00 €
● F004Z030033	78,00 €
● F004Z0F0071	91,00 €

Landlord: Accessoires / Accessories

Mât de sol.
Pour montage sur mât avec base.

Earth stick.
To be mounted on poles with base.

F004Z060000 21,00 €



Système de jonction IP68
H2O Stop anti-condensation
à 3/4 voies 4 pôles.
(Ø5,5÷12mm câble).

3/4 way terminal block 4 poles
IP68 H2O Stop. (ø5,5÷12mm
cable).

F990C010000 60,00 €



Système de jonction IP68
H2O Stop anti-condensation
à 2 voies 4 pôles.
(Ø5,5÷12mm câble).

2 way terminal block 4 poles
IP68 H2O Stop. (ø5,5÷12mm
cable).

F990C00A000 33,00 €



Équipement d'alimentation
pour installation à distance
24Vdc 20W / 110-240Vdc
(15W@110V) IP67 Classe II
selv.

Power supply for remote
installation 24Vdc 20W / 110-
240Vdc (15W@110V) IP67
Class II selv.

Landlord Soft
Only for Dali version
RF26387.A 159,00 €
Dimmable DALI



190

Exemples de Configurations / Examples of Configuration

ON-OFF (non dimmable) = code produit (F004C30A001 + F004Z010001) + alimentation 8W / 110-240Vac / 24Vdc ON-OFF IP65 (RF25748)
 ON-OFF (non dimmable) = luminaire code (F004C30A001 + F004Z010001) + power supply 8W / 110-240Vac / 24Vdc ON-OFF IP65 (RF25748)

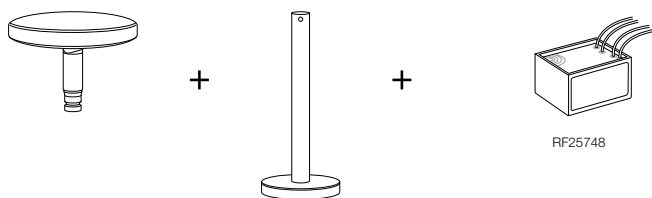

Dimmable 1-10V = code produit (F004C30A001 + F004Z010001) + alimentation 35W / 120-270Vac / 24Vdc 1-10V PWM control IP67 (F990B02A000)
 Dimmable 1-10V = luminaire code (F004C30A001 + F004Z010001) + power supply 35W / 120-270Vac / 24Vdc 1-10V PWM control IP67 (F990B02A000)

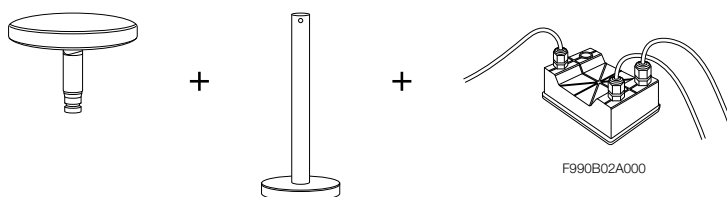

Dimmable 1-10V : interface PWM + alimentation = code produit (F004C30A001 + F004Z010001) + interface de contrôle 1-10V PWM 24Vdc 120W IP67 (F990B00A000) + alimentation 8W / 110-240Vac / 24Vdc ON-OFF IP65 (RF25748) ou autre alimentation à distance 24Vdc

Dimmable 1-10V : PWM control interface + power supply = luminaire code (F004C30A001 + F004Z010001) + PWM control interface 1-10V PWM 24Vdc 120W IP67 (F990B00A000) + power supply 8W / 110-240Vac / 24Vdc ON-OFF IP65 (RF25748) or other remote power supply

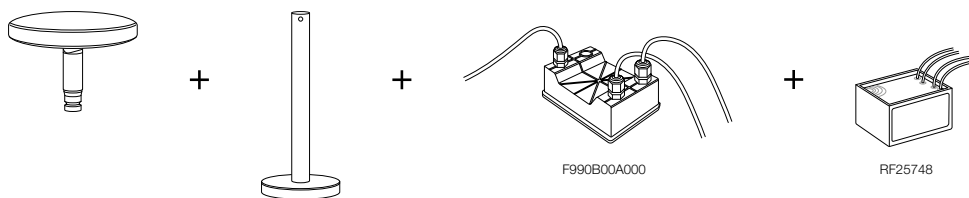

Dimmable DALI = code produit (F004C30A001 + F004Z010001) + alimentation 35W / 120-270Vac / 24Vdc DALI PWM control IP67 (F990B03A000)
 Dimmable DALI = luminaire code (F004C30A001 + F004Z010001) + power supply 35W / 120-270Vac / 24Vdc DALI PWM control IP67 (F990B03A000)

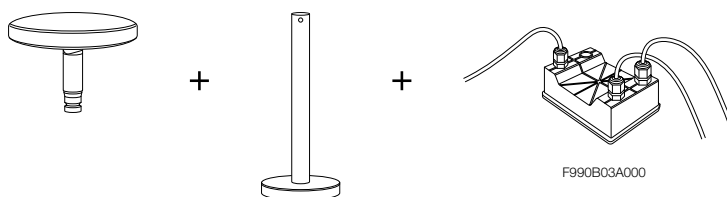

Dimmable DALI : interface PWM + alimentation = code produit F004C30A001 + F004Z010001) + interface de contrôle DALI PWM 24Vdc 120W IP67 (F990B01A000) + alimentation 8W / 110-240Vac / 24Vdc ON-OFF IP65 (RF25748) ou autre alimentation à distance 24Vdc

Dimmable DALI: PWM control interface + power supply = luminaire code (F004C30A001 + F004Z010001) + PWM control interface DALI PWM 24Vdc 120W IP67 (F990B01A000) + power supply 8W / 110-240Vac / 24Vdc ON-OFF IP65 (RF25748) or other remote power supply

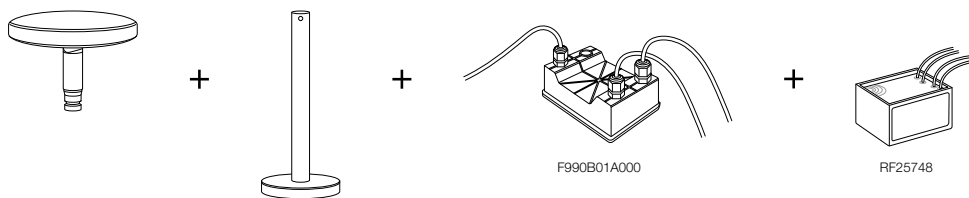

Landlord Ground 49

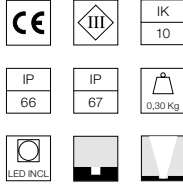
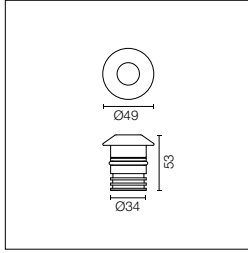

Alimentation 24V à commander séparément.
Nécessite un boîtier d'installation, à commander séparément.

24V remote power supply to be ordered separately.
Necessary box for installation, to be ordered separately.

2200K disponible sur demande.

2200K available on request.

Power Led: 2,3W - 188 lm ≠ *FIXT 121 lm - 2700K/CRI 80 - 24V / 2,3W - 195 lm ≠ *FIXT 125 lm - 3000K/CRI 80 - 24V / 2,3W - 202 lm ≠ *FIXT 130 lm - 4000K/CRI 80 - 24V
*FIXT lm = Spot Optic

Optic Spot 14°

2700K

Non Dimmable

① F004A21A056 150,00 €

PWM Dimmable

① F004A21H056 171,00 €

Non Dimmable with honeycomb

① F004A26A05601 162,00 €

3000K

Non Dimmable

① F004A31A056 150,00 €

PWM Dimmable

① F004A31H056 171,00 €

Non Dimmable with honeycomb

① F004A36A05601 162,00 €

4000K

Non Dimmable

① F004A41A056 150,00 €

PWM Dimmable

① F004A41H056 171,00 €

Non Dimmable with honeycomb

① F004A46A05601 162,00 €

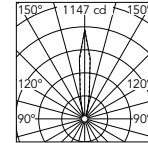

Beam Angle: 14°

@4000K

Optic Medium 40°

2700K

Non Dimmable

① F004A22A056 150,00 €

PWM Dimmable

① F004A22H056 171,00 €

Non Dimmable with honeycomb

① F004A27A05602 162,00 €

3000K

Non Dimmable

① F004A32A056 150,00 €

PWM Dimmable

① F004A32H056 171,00 €

Non Dimmable with honeycomb

① F004A37A05602 162,00 €

4000K

Non Dimmable

① F004A42A056 150,00 €

PWM Dimmable

① F004A42H056 171,00 €

Non Dimmable with honeycomb

① F004A47A05602 162,00 €

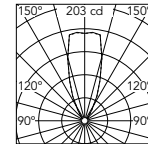

Beam Angle: 40°

@4000K

Landlord Ground 49 1 Beam

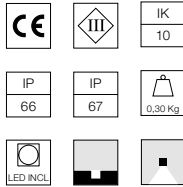
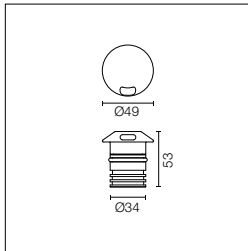

Alimentation 24V à commander séparément.
Nécessite un boîtier d'installation, à commander séparément.

24V remote power supply to be ordered separately.
Necessary box for installation, to be ordered separately.

2200K disponible sur demande.

2200K available on request.

Power Led: 2,3W - 188 lm ≠ FIXT 8 lm - 2700K/CRI 80 - 24V / 2,3W - 195 lm ≠ FIXT 9 lm - 3000K/CRI 80 - 24V / 2,3W - 202 lm ≠ FIXT 9 lm - 4000K/CRI 80 - 24V

2700K

Non Dimmable

① F004A23A056 162,00 €

PWM Dimmable

① F004A23H056 183,00 €

3000K

Non Dimmable

① F004A33A056 162,00 €

PWM Dimmable

① F004A33H056 183,00 €

4000K

Non Dimmable

① F004A43A056 162,00 €

PWM Dimmable

① F004A43H056 183,00 €

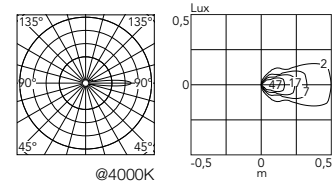

@4000K

Landlord Ground 49 2 Beams

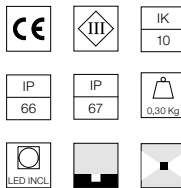
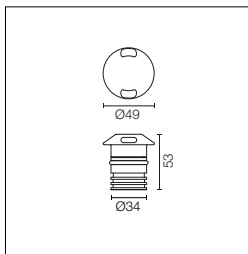

Alimentation 24V à commander séparément.
Nécessite un boîtier d'installation, à commander séparément.

24V remote power supply to be ordered separately.
Necessary box for installation, to be ordered separately.

2200K disponible sur demande.

2200K available on request.

Power Led: 2,3W - 188 lm ≠ FIXT 16 lm - 2700K/CRI 80 - 24V / 2,3W - 195 lm ≠ FIXT 17 lm - 3000K/CRI 80 - 24V / 2,3W - 202 lm ≠ FIXT 18 lm - 4000K/CRI 80 - 24V

2700K		3000K		4000K	
Non Dimmable		Non Dimmable		Non Dimmable	
● F004A24A056	162,00 €	● F004A34A056	162,00 €	● F004A44A056	162,00 €
PWM Dimmable		PWM Dimmable		PWM Dimmable	
● F004A24H056	183,00 €	● F004A34H056	183,00 €	● F004A44H056	183,00 €

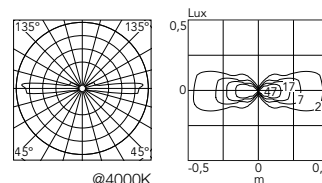

Landlord Ground 49 4 Beams

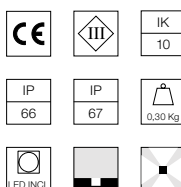
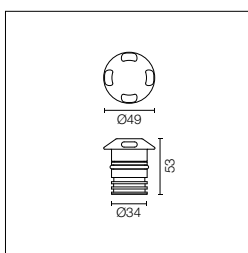

Alimentation 24V à commander séparément.
Nécessite un boîtier d'installation, à commander séparément.

24V remote power supply to be ordered separately.
Necessary box for installation, to be ordered separately.

2200K disponible sur demande.

2200K available on request.

Power Led: 2,3W - 188 lm ≠ FIXT 32 lm - 2700K/CRI 80 - 24V / 2,3W - 195 lm ≠ FIXT 34 lm - 3000K/CRI 80 - 24V / 2,3W - 202 lm ≠ FIXT 36 lm - 4000K/CRI 80 - 24V

2700K		3000K		4000K	
Non Dimmable		Non Dimmable		Non Dimmable	
● F004A25A056	173,00 €	● F004A35A056	173,00 €	● F004A45A056	173,00 €
PWM Dimmable		PWM Dimmable		PWM Dimmable	
● F004A25H056	196,00 €	● F004A35H056	196,00 €	● F004A45H056	196,00 €

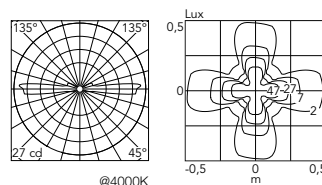

* Nombre maximum de luminaires par source d'alimentation / Maximum number of luminaires per power supply.

Nombre maximum de luminaires par source d'alimentation (220-240 V). Ces données doivent être vérifiées en prenant en compte les conditions spécifiques d'installation.

Maximum number of luminaires per power supply. (220-240 V). These data must be checked taking into account the specific installation conditions.

Non Dimmable		Dimmable	
Acc. RF25754	2	Acc. F990B02A000	13
Acc. RF25748	2	Acc. F990B03A000	13
Acc. RF25747	3	Acc. F990B16A000	13
Acc. RF25757	3	Acc. F990B04A000	28
Acc. F990B23AZ00	9	Acc. F990B05A000	28
Acc. F990B28A000	14	Acc. F990B17A000	28
Acc. F990B27A000	29		

Landlord Ground Ø49: Accessoires / Accessories

Boîtier. Box for installation. F004Z0J000 10,00 €

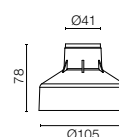

Landlord Ground 64

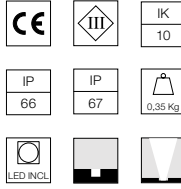
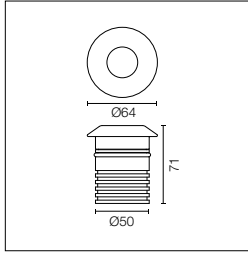

Alimentation 24V à commander séparément.
Nécessite un boîtier d'installation, à commander séparément.

24V remote power supply to be ordered separately.
Necessary box for installation, to be ordered separately.

2200K disponible sur demande.

2200K available on request.

Power Led: 3,4W - 251 lm ≠ *FIXT 183 lm - 2700K/CRI 80 - 24V / 3,4W - 260 lm ≠ *FIXT 189 lm - 3000K/CRI 80 - 24V / 3,4W - 270 lm ≠ *FIXT 196 lm - 4000K/CRI 80 - 24V
*FIXT lm = Spot Optic

Optic Spot 15°

2700K

Non Dimmable

① F004B21A056 198,00 €

PWM Dimmable

① F004B21H056 221,00 €

Non Dimmable with honeycomb

① F004B26A05601 211,00 €

3000K

Non Dimmable

① F004B31A056 198,00 €

PWM Dimmable

① F004B31H056 221,00 €

Non Dimmable with honeycomb

① F004B36A05601 211,00 €

4000K

Non Dimmable

① F004B41A056 198,00 €

PWM Dimmable

① F004B41H056 221,00 €

Non Dimmable with honeycomb

① F004B46A05601 211,00 €

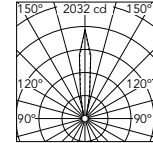

Beam Angle: 15°

h(m)	E(lx)	D(m)
1	2032	0.27
2	508	0.53
3	226	0.80
4	127	1.06
5	81	1.33

@4000K

Optic Medium 25°

2700K

Non Dimmable

① F004B22A056 198,00 €

PWM Dimmable

① F004B22H056 221,00 €

Non Dimmable with honeycomb

① F004B27A05602 211,00 €

3000K

Non Dimmable

① F004B32A056 198,00 €

PWM Dimmable

① F004B32H056 221,00 €

Non Dimmable with honeycomb

① F004B37A05602 211,00 €

4000K

Non Dimmable

① F004B42A056 198,00 €

PWM Dimmable

① F004B42H056 221,00 €

Non Dimmable with honeycomb

① F004B47A05602 211,00 €

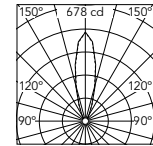

Beam Angle: 25°

h(m)	E(lx)	D(m)
1	678	0.46
2	169	0.92
3	75	1.38
4	42	1.84
5	27	2.30

@4000K

Landlord Ground 64 1 Beam

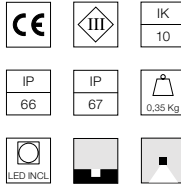
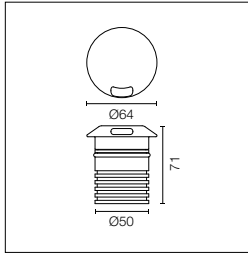

Alimentation 24V à commander séparément.
Nécessite un boîtier d'installation, à commander séparément.

24V remote power supply to be ordered separately.
Necessary box for installation, to be ordered separately.

2200K disponible sur demande.

2200K available on request.

Power Led: 3,4W - 251 lm ≠ FIXT 11 lm - 2700K/CRI 80 - 24V / 3,4W - 260 lm ≠ FIXT 12 lm - 3000K/CRI 80 - 24V / 3,4W - 270 lm ≠ FIXT 12 lm - 4000K/CRI 80 - 24V

2700K

Non Dimmable

① F004B23A056 211,00 €

PWM Dimmable

① F004B23H056 232,00 €

3000K

Non Dimmable

① F004B33A056 211,00 €

PWM Dimmable

① F004B33H056 232,00 €

4000K

Non Dimmable

① F004B43A056 211,00 €

PWM Dimmable

① F004B43H056 232,00 €

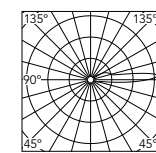

@4000K

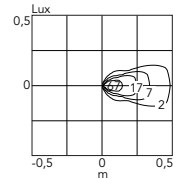

Landlord Ground 64 2 Beams

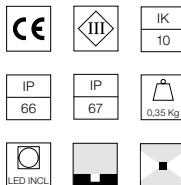
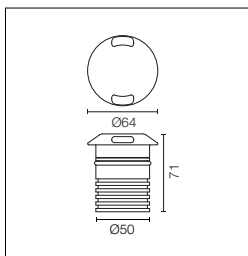

Alimentation 24V à commander séparément.
Nécessite un boîtier d'installation, à commander séparément.

24V remote power supply to be ordered separately.
Necessary box for installation, to be ordered separately.

2200K disponible sur demande.

2200K available on request.

Power Led: 3,4W - 251 lm ≠ FIXT 22 lm - 2700K/CRI 80 - 24V / 3,4W - 260 lm ≠ FIXT 23 lm - 3000K/CRI 80 - 24V / 3,4W - 270 lm ≠ FIXT 24 lm - 4000K/CRI 80 - 24V

2700K		3000K		4000K	
Non Dimmable		Non Dimmable		Non Dimmable	
● F004B24A056	211,00 €	● F004B34A056	211,00 €	● F004B44A056	211,00 €
PWM Dimmable		PWM Dimmable		PWM Dimmable	
● F004B24H056	232,00 €	● F004B34H056	232,00 €	● F004B44H056	232,00 €

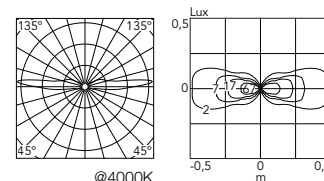

Landlord Ground 64 4 Beams

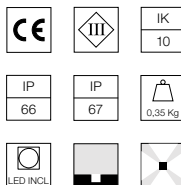
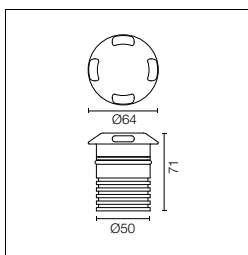

Alimentation 24V à commander séparément.
Nécessite un boîtier d'installation, à commander séparément.

24V remote power supply to be ordered separately.
Necessary box for installation, to be ordered separately.

2200K disponible sur demande.

2200K available on request.

Power Led: 3,4W - 251 lm ≠ FIXT 44 lm - 2700K/CRI 80 - 24V / 3,4W - 260 lm ≠ FIXT 46 lm - 3000K/CRI 80 - 24V / 3,4W - 270 lm ≠ FIXT 48 lm - 4000K/CRI 80 - 24V

2700K		3000K		4000K	
Non Dimmable		Non Dimmable		Non Dimmable	
● F004B25A056	228,00 €	● F004B35A056	228,00 €	● F004B45A056	228,00 €
PWM Dimmable		PWM Dimmable		PWM Dimmable	
● F004B25H056	251,00 €	● F004B35H056	251,00 €	● F004B45H056	251,00 €

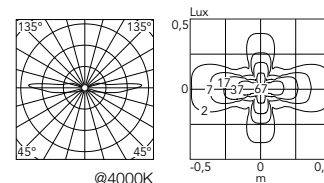

* Nombre maximum de luminaires par source d'alimentation / Maximum number of luminaires per power supply.

Nombre maximum de luminaires par source d'alimentation (220÷240 V). Ces données doivent être vérifiées en prenant en compte les conditions spécifiques d'installation.	Maximum number of luminaires per power supply. (220÷240 V). These data must be checked taking into account the specific installation conditions.	Non Dimmable		Dimmable	
		Acc.	Qty	Acc.	Qty
		Acc. RF25754	1	Acc. F990B02A000	7
		Acc. RF25748	1	Acc. F990B03A000	7
		Acc. RF25747	3	Acc. F990B16A000	7
		Acc. RF25757	3	Acc. F990B04A000	17
		Acc. F990B23AZ00	7	Acc. F990B05A000	17
		Acc. F990B28A000	9	Acc. F990B17A000	17
		Acc. F990B27A000	17		

Landlord Ground Ø64: Accessoires / Accessories

Boîtier. Box for installation. F004Z0K000 10,00 €

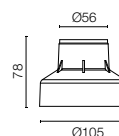

Landlord: Accessoires / Accessories

Système de jonction IP68 à 2 voies 2 pôles. (Ø4±6,9mm câble).
Il ne peut pas être placé dans le boîtier encastré pour l'installation.

2 way terminal block 2 poles IP68. (Ø4±6,9mm cable).
It can't be placed in the recessed box for installation.

F990C050000

34,00 €



Landlord (all versions): Power Supply Dimmable

Alimentation 24V PWM avec interface de contrôle 1-10V IP67 Classe II. Vin 120-270 Vac.

Power supply 24v PWM with 1-10V control interface IP67 Class II. Vin 120-270 Vac.

35W

*F990B02A000

350,00 €

70W

*F990B04A000

404,00 €

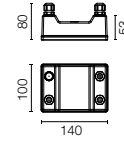
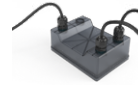

Alimentation 24V PWM avec interface de contrôle DALI IP67 Classe II. Vin 120-270 Vac.

Power supply 24v PWM with DALI control interface IP67 Class II. Vin 120-270 Vac.

35W

*F990B03A000

350,00 €

70W

*F990B05A000

404,00 €

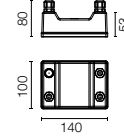
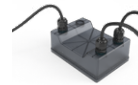

Alimentation 24V PWM avec interface de contrôle PUSH IP67 Classe II. Vin 120-270 Vac.

Power supply 24v PWM with PUSH control interface IP67 Class II. Vin 120-270 Vac.

35W

*F990B16A000

350,00 €

70W

*F990B17A000

404,00 €

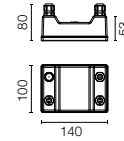
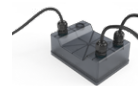

Interface de contrôle 24V PWM - 1-10V IP67 Class III. Vin 24Vdc 120W (Alimentation non comprise).

Control interface 24V PWM - 1-10V IP67 Class III. Vin 24Vdc 120W (Power supply not included).

F990B00A000

208,00 €

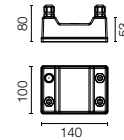
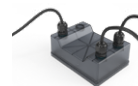

Interface de contrôle 24V PWM - Dali IP67 Class III. Vin 24Vdc 120W (Alimentation non comprise).

Control interface 24V PWM - Dali IP67 Class III. Vin 24Vdc 120W (Power supply not included).

F990B01A000

208,00 €

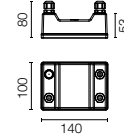
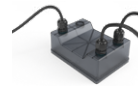

Interface de contrôle 24V PWM - Push IP67 Class III. Vin 24Vdc 120W (Alimentation non comprise).

Control interface 24V PWM - Push IP67 Class III. Vin 24Vdc 120W (Power supply not included).

F990B18A000

208,00 €

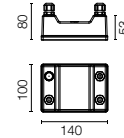
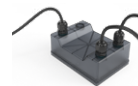

Landlord: Power Supply Non Dimmable

Équipement d'alimentation double fonction 24V / 350mA IP20 Classe II selv. non gradable.	Power supply dual function 24V / 350mA IP20 Class II selv. no dimmable.	*RF25754	36,00 €		
Équipement d'alimentation double fonction 24V / lout 350mA 110-240V IP65.	Power supply dual function 24V / lout 350mA 110-240V IP65.	*RF25748	63,00 €		
Équipement d'alimentation 24V 10W / 110-240V IP20 Classe II selv.	Power supply 24V 10W / 110-240V IP20 Class II selv.	*RF25747	48,00 €		
Équipement d'alimentation 24V 10W / 110-240V IP67 Classe II selv.	Power supply 24V 10W / 110-240V IP67 Class II selv.	*RF25757	86,00 €		
Alimentation 24Vdc 35W / 120-270V IP67 Class II selv.	Power supply 24Vdc 35W / 120-270V IP67 Class II selv.	F990B23AZ00	180,00 €		
Équipement d'alimentation 24Vdc 50W / 120-240V IP67 Classe II selv.	Power supply 24Vdc 50W / 120-240V IP67 Class II selv.	*F990B28A000	251,00 €		
Équipement d'alimentation 24Vdc 70W / 220-240V IP67 Classe II selv.	Power supply 24Vdc 70W / 220-240V IP67 Class II selv.	*F990B27A000	212,00 €		

Bellhop

Designed by Edward Barber & Jay Osgerby



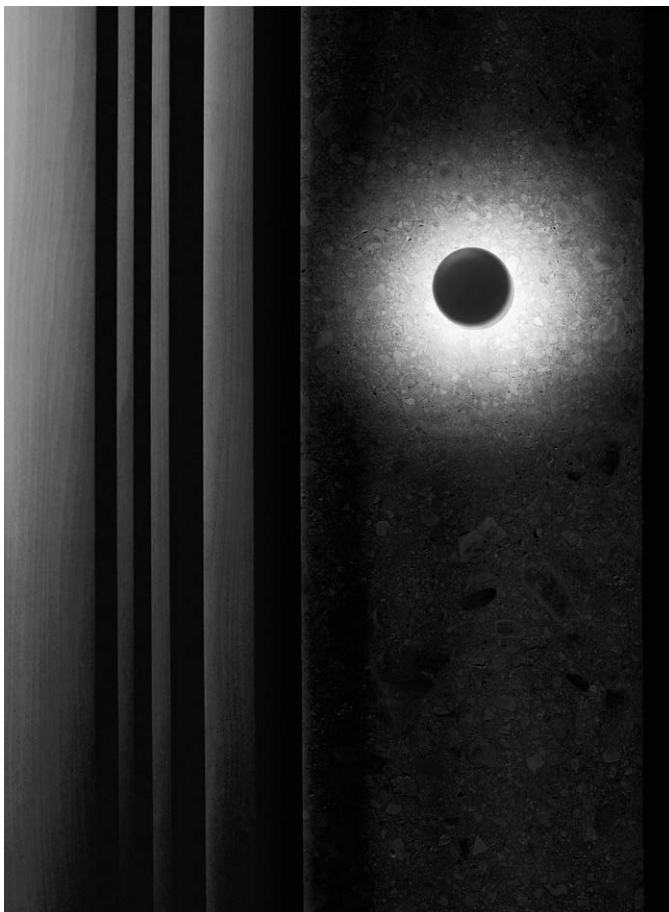

Bellhop Wall

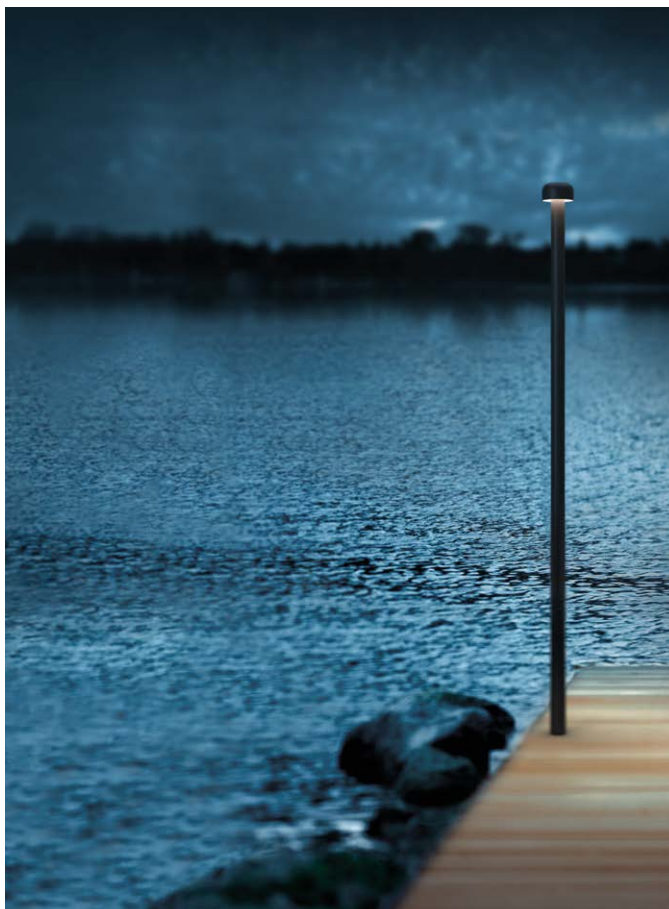

Bellhop Pole



Bellhop Bollard

Famille / Family

Bellhop Wall

Bellhop Bollard

Bellhop Pole



Power Led

8W
551 lm - 2700K/CRI 80
580 lm - 3000K/CRI 80
607 lm - 4000K/CRI 80
2200K available on request.

Power Led

8W
551 lm - 2700K/CRI 80
580 lm - 3000K/CRI 80
607 lm - 4000K/CRI 80
2200K available on request.

Power Led

30W
2490 lm - 2700K/CRI 80
2590 lm - 3000K/CRI 80
2760 lm - 4000K/CRI 80
2200K available on request.

Finitions / Colours



01 White*

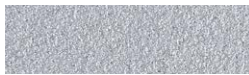

06 Grey

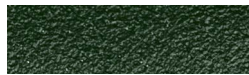

12 Forest Green*



18 Deep Brown



30 Black*



33 Anthracite

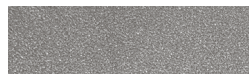

56 Matt Stainless
Steel*

* Uniquement pour les versions bollard et mur. / Only for bollard and wall versions.

Bellhop Wall

Applique murale d'extérieur de la collection Bellhop pour une lumière diffuse, en aluminium extrudé et moulé sous pression ou en acier inoxydable.

Bellhop Bollard

Version borne d'extérieur de la collection Bellhop pour lumière diffuse. En aluminium extrudé et moulé sous pression ou en acier inoxydable, Bellhop est disponible en deux hauteurs de borne et avec différents lumens et types de branchement pour répondre à tout type d'aménagement extérieur et tout scénario lumineux.

Bellhop Pole

Version sur mât de la collection Bellhop pour lumière diffuse.
Tête en aluminium montée sur un mât extrudé de 3m ou 4m de long, pour installation sur surfaces rigides ou dans le sol.

Bellhop Wall

Wall light version of the Bellhop Outdoor Collection for diffuse light, made of extruded and die-cast aluminium or stainless steel.

Bellhop Bollard

Bollard version of the Bellhop Outdoor Collection for diffuse light. Made of extruded and die-cast aluminium or stainless steel, Bellhop is available in two heights for the bollard model and with different lumens and luminaire outputs as to comply with any outdoor setting and lighting scenario need.

Bellhop Pole

Pole version of the Bellhop Outdoor Collection for diffuse light.
Aluminum head mounted on a 3m or 4m long extruded pole, available for installation on rigid surface or in ground.

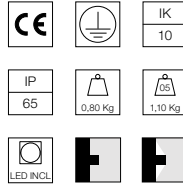
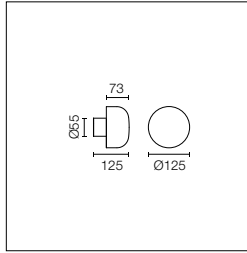

Alimentation 100-240V intégrée.
 Fixation murale directe.
 Chaque appareil d'éclairage est équipé d'un segment de câble de 200 mm pour la connexion à l'intérieur du corps de l'appareil. La connexion est conseillée avec un système de jonction IP68 H₂O Stop anti condensation à 2 voies 4 pôles, à commander séparément.

100-240V power supply integrated. Direct wall installation.
 Each luminaire is equipped with 200 mm length cable for connection inside the luminaire body.
 Recommended connection with a 2 way terminal block 4 poles IP68 H₂O Stop, to be ordered separately.

2200K disponible sur demande.

2200K available on request.

Power Led: 8W - 783 lm ≠ FIXT 551 lm - 2700K/CRI 80 - 100-240V / 8W - 816 lm ≠ FIXT 580 lm - 3000K/CRI 80 - 100-240V / 8W - 873 lm ≠ FIXT 607 lm - 4000K/CRI 80 - 100-240V

2700K

Non Dimmable

○ F003C21A001	372,00 €
● F003C21A006	372,00 €
● F003C21A012	372,00 €
● F003C21A018	372,00 €
● F003C21A030	372,00 €
● F003C21A033	372,00 €
● F003C21A056	447,00 €
1-10V	
○ F003C21B001	435,00 €
● F003C21B006	435,00 €
● F003C21B012	435,00 €
● F003C21B018	435,00 €
● F003C21B030	435,00 €
● F003C21B033	435,00 €
● F003C21B056	511,00 €
Dali	
○ F003C21D001	435,00 €
● F003C21D006	435,00 €
● F003C21D012	435,00 €
● F003C21D018	435,00 €
● F003C21D030	435,00 €
● F003C21D033	435,00 €
● F003C21D056	511,00 €

3000K

Non Dimmable

○ F003C31A001	372,00 €
● F003C31A006	372,00 €
● F003C31A012	372,00 €
● F003C31A018	372,00 €
● F003C31A030	372,00 €
● F003C31A033	372,00 €
● F003C31A056	447,00 €
1-10V	
○ F003C31B001	435,00 €
● F003C31B006	435,00 €
● F003C31B012	435,00 €
● F003C31B018	435,00 €
● F003C31B030	435,00 €
● F003C31B033	435,00 €
● F003C31B056	511,00 €
Dali	
○ F003C31D001	435,00 €
● F003C31D006	435,00 €
● F003C31D012	435,00 €
● F003C31D018	435,00 €
● F003C31D030	435,00 €
● F003C31D033	435,00 €
● F003C31D056	511,00 €

4000K

Non Dimmable

○ F003C41A001	372,00 €
● F003C41A006	372,00 €
● F003C41A012	372,00 €
● F003C41A018	372,00 €
● F003C41A030	372,00 €
● F003C41A033	372,00 €
● F003C41A056	447,00 €
1-10V	
○ F003C41B001	435,00 €
● F003C41B006	435,00 €
● F003C41B012	435,00 €
● F003C41B018	435,00 €
● F003C41B030	435,00 €
● F003C41B033	435,00 €
● F003C41B056	511,00 €
Dali	
○ F003C41D001	435,00 €
● F003C41D006	435,00 €
● F003C41D012	435,00 €
● F003C41D018	435,00 €
● F003C41D030	435,00 €
● F003C41D033	435,00 €
● F003C41D056	511,00 €

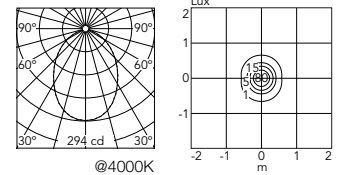

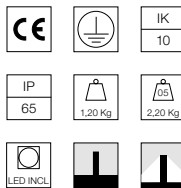
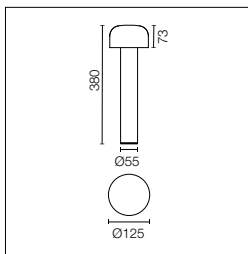

Alimentation 100-240V incluse. Prévu pour installation sur base rigide. Chaque appareil d'éclairage est équipé d'un segment de câble de 200 mm pour la connexion à l'intérieur du corps de l'appareil. La connexion est conseillée avec un système de jonction IP68 H₂O Stop anti condensation à 2 voies 4 pôles, à commander séparément.

100-240V power supply included. Ready for installation on solid surface. Each luminaire is equipped with 200 mm cable for connection inside the luminaire body. Recommended connection with a 2 way terminal block 4 poles IP68 H₂O Stop, to be ordered separately.

2200K disponible sur demande.

2200K available on request.

Power Led: 8W - 783 lm ≠ FIXT 551 lm - 2700K/CRI 80 - 100-240V / 8W - 816 lm ≠ FIXT 580 lm - 3000K/CRI 80 - 100-240V / 8W - 873 lm ≠ FIXT 607 lm - 4000K/CRI 80 - 100-240V

2700K

Non Dimmable

- F003A21A001 416,00 €
 - F003A21A006 416,00 €
 - F003A21A012 416,00 €
 - F003A21A018 416,00 €
 - F003A21A030 416,00 €
 - F003A21A033 416,00 €
 - F003A21A056 540,00 €
- 1-10V
- F003A21B001 476,00 €
 - F003A21B006 476,00 €
 - F003A21B012 476,00 €
 - F003A21B018 476,00 €
 - F003A21B030 476,00 €
 - F003A21B033 476,00 €
 - F003A21B056 600,00 €
- Dali

- F003A21D001 476,00 €
- F003A21D006 476,00 €
- F003A21D012 476,00 €
- F003A21D018 476,00 €
- F003A21D030 476,00 €
- F003A21D033 476,00 €
- F003A21D056 600,00 €

3000K

Non Dimmable

- F003A31A001 416,00 €
 - F003A31A006 416,00 €
 - F003A31A012 416,00 €
 - F003A31A018 416,00 €
 - F003A31A030 416,00 €
 - F003A31A033 416,00 €
 - F003A31A056 540,00 €
- 1-10V
- F003A31B001 476,00 €
 - F003A31B006 476,00 €
 - F003A31B012 476,00 €
 - F003A31B018 476,00 €
 - F003A31B030 476,00 €
 - F003A31B033 476,00 €
 - F003A31B056 600,00 €
- Dali

- F003A31D001 476,00 €
- F003A31D006 476,00 €
- F003A31D012 476,00 €
- F003A31D018 476,00 €
- F003A31D030 476,00 €
- F003A31D033 476,00 €
- F003A31D056 600,00 €

4000K

Non Dimmable

- F003A41A001 416,00 €
 - F003A41A006 416,00 €
 - F003A41A012 416,00 €
 - F003A41A018 416,00 €
 - F003A41A030 416,00 €
 - F003A41A033 416,00 €
 - F003A41A056 540,00 €
- 1-10V
- F003A41B001 476,00 €
 - F003A41B006 476,00 €
 - F003A41B012 476,00 €
 - F003A41B018 476,00 €
 - F003A41B030 476,00 €
 - F003A41B033 476,00 €
 - F003A41B056 600,00 €
- Dali

- F003A41D001 476,00 €
- F003A41D006 476,00 €
- F003A41D012 476,00 €
- F003A41D018 476,00 €
- F003A41D030 476,00 €
- F003A41D033 476,00 €
- F003A41D056 600,00 €

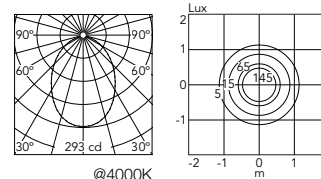

Bellhop Bollard 850

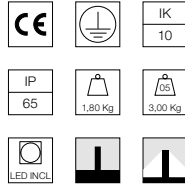
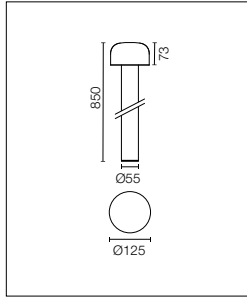

Alimentation 100-240V incluse.
Prévu pour installation sur base rigide.
Chaque appareil d'éclairage est équipé d'un segment de câble de 200 mm pour la connexion à l'intérieur du corps de l'appareil.
La connexion est conseillée avec un système de jonction IP68 H₂O Stop anti condensation à 2 voies 4 pôles, à commander séparément.

100-240V power supply included. Ready for installation on solid surface.
Each luminaire is equipped with 200 mm cable for connection inside the luminaire body.
Reccomended connection with a 2 way terminal block 4 poles IP68 H₂O Stop, to be ordered separately.

2200K disponible sur demande.

2200K available on request.

Power Led: 8W - 783 lm ≠ FIXT 551 lm - 2700K/CRI 80 - 100-240V / 8W - 816 lm ≠ FIXT 580 lm - 3000K/CRI 80 - 100-240V / 8W - 873 lm ≠ FIXT 607 lm - 4000K/CRI 80 - 100-240V

2700K

Non Dimmable

○ F003B21A001	447,00 €
● F003B21A006	447,00 €
● F003B21A012	447,00 €
● F003B21A018	447,00 €
● F003B21A030	447,00 €
● F003B21A033	447,00 €
● F003B21A056	620,00 €
1-10V	
○ F003B21B001	511,00 €
● F003B21B006	511,00 €
● F003B21B012	511,00 €
● F003B21B018	511,00 €
● F003B21B030	511,00 €
● F003B21B033	511,00 €
● F003B21B056	681,00 €
Dali	
○ F003B21D001	511,00 €
● F003B21D006	511,00 €
● F003B21D012	511,00 €
● F003B21D018	511,00 €
● F003B21D030	511,00 €
● F003B21D033	511,00 €
● F003B21D056	681,00 €

3000K

Non Dimmable

○ F003B31A001	447,00 €
● F003B31A006	447,00 €
● F003B31A012	447,00 €
● F003B31A018	447,00 €
● F003B31A030	447,00 €
● F003B31A033	447,00 €
● F003B31A056	620,00 €
1-10V	
○ F003B31B001	511,00 €
● F003B31B006	511,00 €
● F003B31B012	511,00 €
● F003B31B018	511,00 €
● F003B31B030	511,00 €
● F003B31B033	511,00 €
● F003B31B056	681,00 €
Dali	
○ F003B31D001	511,00 €
● F003B31D006	511,00 €
● F003B31D012	511,00 €
● F003B31D018	511,00 €
● F003B31D030	511,00 €
● F003B31D033	511,00 €
● F003B31D056	681,00 €

4000K

Non Dimmable

○ F003B41A001	447,00 €
● F003B41A006	447,00 €
● F003B41A012	447,00 €
● F003B41A018	447,00 €
● F003B41A030	447,00 €
● F003B41A033	447,00 €
● F003B41A056	620,00 €
1-10V	
○ F003B41B001	511,00 €
● F003B41B006	511,00 €
● F003B41B012	511,00 €
● F003B41B018	511,00 €
● F003B41B030	511,00 €
● F003B41B033	511,00 €
● F003B41B056	681,00 €
Dali	
○ F003B41D001	511,00 €
● F003B41D006	511,00 €
● F003B41D012	511,00 €
● F003B41D018	511,00 €
● F003B41D030	511,00 €
● F003B41D033	511,00 €
● F003B41D056	681,00 €

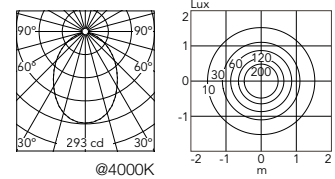

Bellhop Bollard: Accessoires / Accessories

Plaque de boulons.

Base plate with bolt.

Bellhop Bollard Ø125

F003Z010000

24,00 €

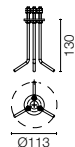

Bellhop Pole with base

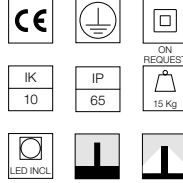
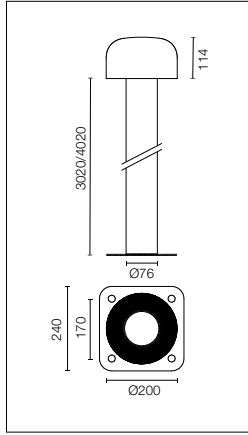
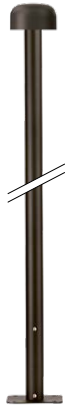

Alimentation 220-240V incluse. Prévu pour installation sur base rigide.
 Base disponible en accessoire. Chaque appareil d'éclairage est équipé d'un segment de câble de 200 mm pour la connexion à l'intérieur du corps de l'appareil. La connexion est conseillée avec un système de jonction IP68 H₂O Stop anti condensation à 2 voies 4 pôles, à commander séparément. Version 110V et dimmable disponible sur demande.

220-240V power supply included. Ready for installation on solid surface. Base plate available as accessory. Each luminaire is equipped with 200 mm cable for connection inside the luminaire body. Recommended connection with a 2 way terminal block 4 poles IP68 H₂O Stop, to be ordered separately. 110V and dimmable versions available on request.

2200K disponible sur demande.

2200K available on request.

Power Led: 30W - 3090 lm ≠ FIXT 2490 lm - 2700K/CRI 80 - 220-240V / 30W - 3220 lm ≠ FIXT 2590 lm - 3000K/CRI 80 - 220-240V / 30W - 3430 lm ≠ FIXT 2760 lm - 4000K/CRI 80 - 220-240V

2700K

- H 3020 mm
Non Dimmable
- F003H21A006 1.082,00 €
 - F003H21A018 1.082,00 €
 - F003H21A033 1.082,00 €
- 1-10V
- F003H21B006 1.210,00 €
 - F003H21B018 1.210,00 €
 - F003H21B033 1.210,00 €
- Dali
- F003H21D006 1.210,00 €
 - F003H21D018 1.210,00 €
 - F003H21D033 1.210,00 €

3000K

- H 3020 mm
Non Dimmable
- F003H31A006 1.082,00 €
 - F003H31A018 1.082,00 €
 - F003H31A033 1.082,00 €
- 1-10V
- F003H31B006 1.210,00 €
 - F003H31B018 1.210,00 €
 - F003H31B033 1.210,00 €
- Dali
- F003H31D006 1.210,00 €
 - F003H31D018 1.210,00 €
 - F003H31D033 1.210,00 €

4000K

- H 3020 mm
Non Dimmable
- F003H41A006 1.082,00 €
 - F003H41A018 1.082,00 €
 - F003H41A033 1.082,00 €
- 1-10V
- F003H41B006 1.210,00 €
 - F003H41B018 1.210,00 €
 - F003H41B033 1.210,00 €
- Dali
- F003H41D006 1.210,00 €
 - F003H41D018 1.210,00 €
 - F003H41D033 1.210,00 €

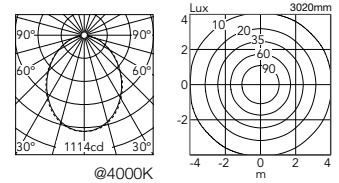

2700K

- H 4020 mm
Non Dimmable
- F003L21A006 1.210,00 €
 - F003L21A018 1.210,00 €
 - F003L21A033 1.210,00 €
- 1-10V
- F003L21B006 1.340,00 €
 - F003L21B018 1.340,00 €
 - F003L21B033 1.340,00 €
- Dali
- F003L21D006 1.340,00 €
 - F003L21D018 1.340,00 €
 - F003L21D033 1.340,00 €

3000K

- H 4020 mm
Non Dimmable
- F003L31A006 1.210,00 €
 - F003L31A018 1.210,00 €
 - F003L31A033 1.210,00 €
- 1-10V
- F003L31B006 1.340,00 €
 - F003L31B018 1.340,00 €
 - F003L31B033 1.340,00 €
- Dali
- F003L31D006 1.340,00 €
 - F003L31D018 1.340,00 €
 - F003L31D033 1.340,00 €

4000K

- H 4020 mm
Non Dimmable
- F003L41A006 1.210,00 €
 - F003L41A018 1.210,00 €
 - F003L41A033 1.210,00 €
- 1-10V
- F003L41B006 1.340,00 €
 - F003L41B018 1.340,00 €
 - F003L41B033 1.340,00 €
- Dali
- F003L41D006 1.340,00 €
 - F003L41D018 1.340,00 €
 - F003L41D033 1.340,00 €

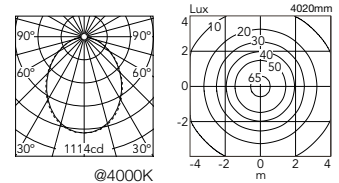

Bellhop Pole: Accessoires / Accessories

Platine à boulons pour Bellhop mât version avec base.

Base plate with bolt for Bellhop Pole with base version.

Bellhop Pole Ø200

F990G300000

97,00 €

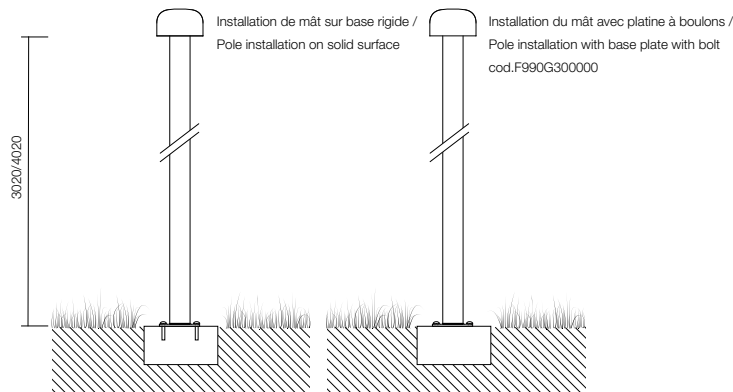
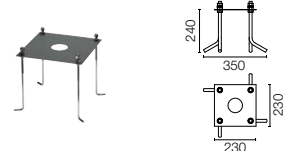

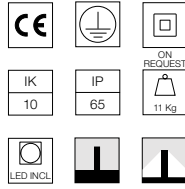
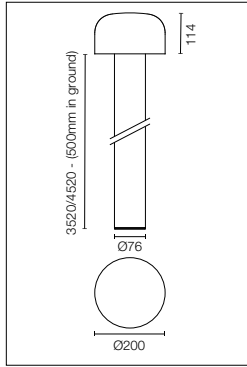
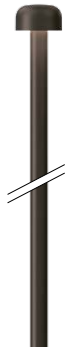

Alimentation 220-240V incluse.
Prêt pour installation au sol.
Chaque appareil d'éclairage est équipé d'un segment de câble de 200 mm pour la connexion à l'intérieur du corps de l'appareil.
La connexion est conseillée avec un système de jonction IP68 H₂O Stop anti condensation à 2 voies 4 pôles, à commander séparément.
Version 110V et dimmable disponible sur demande.

220-240V power supply included.
Ready for inground installation.
Each luminaire is equipped with 200 mm cable for connection inside the luminaire body.
Reccomended connection wit a 2 way terminal block 4 poles IP68 H₂O Stop, to be ordered separately.
110V and dimmable versions available on request.

2200K disponible sur demande.

2200K available on request.

Power Led: 30W - 3090 lm ≠ FIXT 2490 lm - 2700K/CRI 80 - 220-240V / 30W - 3220 lm ≠ FIXT 2590 lm - 3000K/CRI 80 - 220-240V / 30W - 3430 lm ≠ FIXT 2760 lm - 4000K/CRI 80 - 220-240V

2700K

H 3520 mm
Non Dimmable

- F003G21A006 908,00 €
- F003G21A018 908,00 €
- F003G21A033 908,00 €
- 1-10V
- F003G21B006 1.039,00 €
- F003G21B033 1.039,00 €
- F003G21B018 1.039,00 €
- Dali
- F003G21D006 1.039,00 €
- F003G21D018 1.039,00 €
- F003G21D033 1.039,00 €

3000K

H 3520 mm
Non Dimmable

- F003G31A006 908,00 €
- F003G31A018 908,00 €
- F003G31A033 908,00 €
- 1-10V
- F003G31B006 1.039,00 €
- F003G31B018 1.039,00 €
- F003G31B033 1.039,00 €
- Dali
- F003G31D006 1.039,00 €
- F003G31D018 1.039,00 €
- F003G31D033 1.039,00 €

4000K

H 3520 mm
Non Dimmable

- F003G41A006 908,00 €
- F003G41A018 908,00 €
- F003G41A033 908,00 €
- 1-10V
- F003G41B006 1.039,00 €
- F003G41B018 1.039,00 €
- F003G41B033 1.039,00 €
- Dali
- F003G41D006 1.039,00 €
- F003G41D018 1.039,00 €
- F003G41D033 1.039,00 €

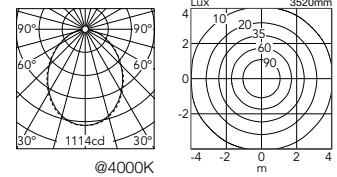

2700K

H 4520 mm
Non Dimmable

- F003K21A006 1.039,00 €
- F003K21A018 1.039,00 €
- F003K21A033 1.039,00 €
- 1-10V
- F003K21B006 1.168,00 €
- F003K21B018 1.168,00 €
- F003K21B033 1.168,00 €
- Dali
- F003K21D006 1.168,00 €
- F003K21D018 1.168,00 €
- F003K21D033 1.168,00 €

3000K

H 4520 mm
Non Dimmable

- F003K31A006 1.039,00 €
- F003K31A018 1.039,00 €
- F003K31A033 1.039,00 €
- 1-10V
- F003K31B006 1.168,00 €
- F003K31B018 1.168,00 €
- F003K31B033 1.168,00 €
- Dali
- F003K31D006 1.168,00 €
- F003K31D018 1.168,00 €
- F003K31D033 1.168,00 €

4000K

H 4520 mm
Non Dimmable

- F003K41A006 1.039,00 €
- F003K41A018 1.039,00 €
- F003K41A033 1.039,00 €
- 1-10V
- F003K41B006 1.168,00 €
- F003K41B018 1.168,00 €
- F003K41B033 1.168,00 €
- Dali
- F003K41D006 1.168,00 €
- F003K41D018 1.168,00 €
- F003K41D033 1.168,00 €

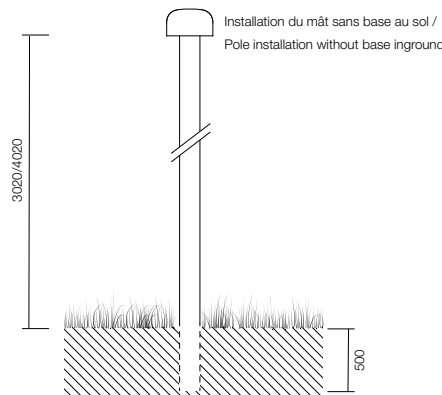
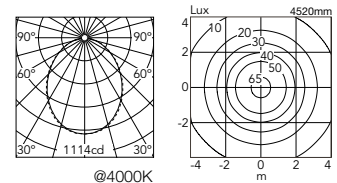

Bellhop Pole: Accessoires / Accessories

Système de jonction IP68
H₂O Stop anti-condensation à
2 voies 4 pôles. (Ø5,5÷12mm
câble).

2 way terminal block 4 poles
IP68 H₂O Stop.
(Ø5,5÷12mm cable).

Bellhop Wall / Bollard / Pole

F990C00A000

33,00 €



Dispositif de protection
contre les surtensions.
275Vac. Courant de
décharge maximal 10KA
(8/20us). Courant de
fonctionnement maximal 5A.
Adapté pour les connexions
en série. IP66.

Surge protection device.
275Vac. Maximum discharge
current 10KA (8/20us).
Maximum operating current
5A. Suitable for series
connection. IP66.

Bellhop Wall / Bollard / Pole

F990E00A000

116,00 €

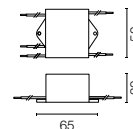

Casting

Designed by Vincent Van Duysen



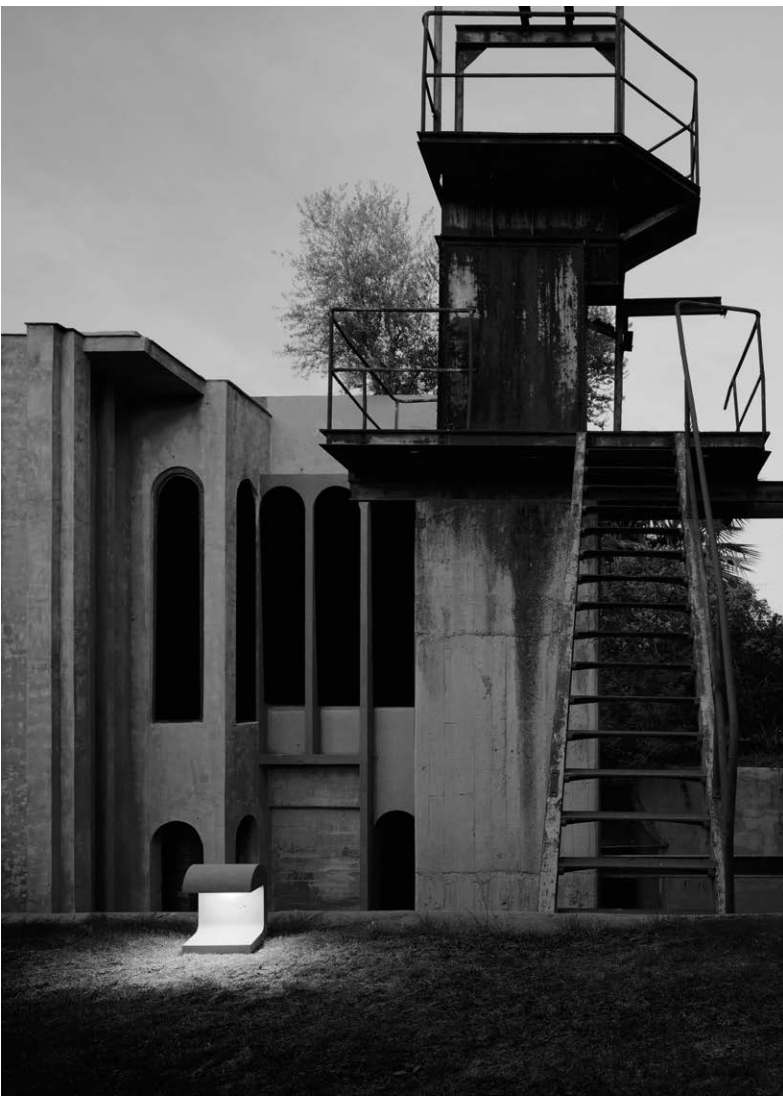

Casting Concrete

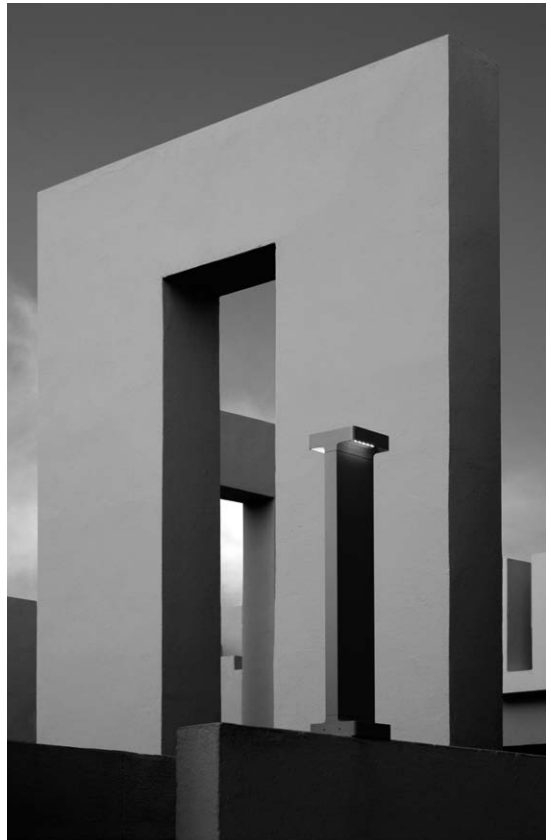

Casting T



Famille / Family

Casting Concrete



Power Led

9W
427 lm - 2700K/CRI 80
513 lm - 3000K/CRI 80
526 lm - 4000K/CRI 80

Casting C

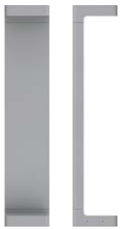

W: **100**
H: 200 / **500** / 700 mm

Power Led

7W
272 lm - 2700K/CRI 80
295 lm - 3000K/CRI 80
317 lm - 4000K/CRI 80

2200K available on request.



W: **150**
H: 250 / **500** / 850 mm

Power Led

12W
565 lm - 2700K/CRI 80
813 lm - 3000K/CRI 80
660 lm - 4000K/CRI 80

2200K available on request.

Casting T



W: **100**
H: 200 / **500** / 700 mm

Power Led

12W
2x272 lm - 2700K/CRI 80
2x295 lm - 3000K/CRI 80
2x317 lm - 4000K/CRI 80

2200K available on request.



W: **150**
H: 250 / **500** / 850 mm

Power Led

21W
2x565 lm - 2700K/CRI 80
2x813 lm - 3000K/CRI 80
2x660 lm - 4000K/CRI 80

2200K available on request.

Finitions / Colours

Casting Concrete



89 Concrete

Casting C / T



01 White

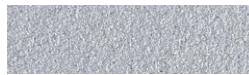

06 Grey



12 Forest Green



18 Deep Brown



30 Black



33 Anthracite

Collection de bornes lumineuses d'extérieur à LED.

Casting Concrete

Le corps de la version Concrete est moulé, en béton coulé composé de ciment, d'agrégats et de fibres de renforcement. Chaque pièce est réalisée individuellement et artisanalement : de légères différences esthétiques et de coloris peuvent exister d'un appareil à un autre, elles attestent du caractère unique de chaque lampe. Chaque appareil est équipé d'un diffuseur en polycarbonate satiné collé au dissipateur du produit pour garantir son étanchéité (stabilisé aux rayons UV pour éviter son jaunissement).

L'appareil est pré-câblé avec câble sortant en néoprène, avec un kit de connexion électrique pour câble multipolaire simple et avec des chevilles pour l'installation sur des surfaces pleines et solides.

La plaque de fixation pour installation sur béton, sur ciment projeté ou sur socle sont disponibles parmi les accessoires.

Casting C/T

Le corps des versions C et T est en aluminium extrudé, base et diffuseur en aluminium moulé sous pression EN AB-47100 à faible teneur en cuivre.

Revêtement à haute résistance : après un traitement de sablage de tous les composants pour rendre la surface poreuse et garantir une meilleure adhérence de la peinture, le revêtement externe est appliqué en double couche avec poudres selon le label QUALICOAT. La première couche de poudres epoxydiques assure la résistance chimique et mécanique; la seconde couche de finition de poudres polyester garantit la résistance aux rayons UV et aux agents atmosphériques.

Les surfaces peintes sont traitées par lavages alcalins et acides, rincées à l'eau déminéralisée puis soumises à un traitement de conversion chimique pour les protéger de l'oxydation. Diffuseur en verre collé au dissipateur du produit pour garantir son étanchéité, et microtexturé pour offrir une distribution homogène et uniforme de la lumière.

L'appareil est pré-câblé avec câble sortant en néoprène.

Collection of outdoor bollard lights with LED light source.

Casting Concrete

The body of the Round version is made from a mould, with poured concrete consisting of cement, fine inert materials for aggregating purposes, and reinforcing fibers. Each article is manufactured individually with a handcrafted process: minor aesthetic and color differences between one luminaire and another are the sign of the uniqueness of each lamp. Each luminaire has a frosted polycarbonate diffuser glued to the heat sink of the product to ensure a watertight seal (UV stabilized to minimise yellowing).

The luminaire is provided with a segment of outgoing cable in neoprene, with a kit of electrical connection for single multicore cable, and with dowels for installation on full and solid surfaces. The fixing plate for installation on cement paving, poured concrete, or on plinth is available as an accessory.

Casting C/T

The body of the versions C and T is made of extruded aluminum, base and diffuser in die-cast aluminum EN AB-47100 with a low copper content.

High-resistance coating: after a sandblasting treatment of all components to make the surface porous and ensure a greater adhesion of the paint, the external coating is applied with a double layer with epoxy powders according to the QUALICOAT standard. The first layer of epoxy powder gives chemical and mechanical resistance, the second finishing layer of polyester powder ensures resistance to UV rays and atmospheric agents. The painted surfaces are treated with alkaline and acidic washes, then rinsed with demineralized water, subjected to a chemical conversion treatment to protect against oxidation. A glass diffuser is glued to the heat sink of the product to ensure a watertight seal, micro-texturized to ensure homogeneous and uniform distribution of the light.

The luminaire is provided with a segment of outgoing cable in neoprene.

Casting Concrete

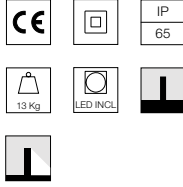
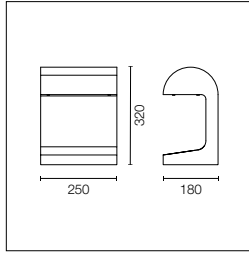

Alimentation 220/240V intégrée.

220/240V power supply integrated.

Power Led: 9W - 650 lm ≠ FIXT 427 lm - 2700K/CRI 80 - 220-240V / 9W - 780 lm ≠ FIXT 513 lm - 3000K/CRI 80 - 220-240V / 9W - 800 lm ≠ FIXT 526 lm - 4000K/CRI 80 - 220-240V

2700K

● F1330089.A 755,00 €

3000K

● F1331089.A 755,00 €

4000K

● F1332089.A 755,00 €

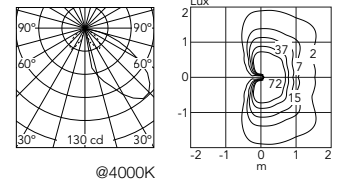

Casting Concrete: Accessoires / Accessories

Plaque de boulons. Base plate with bolt. F1209000 36,00 €



Système de jonction IP68 H2O Stop anti-condensation à 3/4 voies 4 pôles. (Ø5,5÷12mm câble). 3/4 way terminal block 4 poles IP68 H2O Stop. (Ø5,5÷12mm cable). F990C010000 60,00 €



Dispositif de protection contre les surtensions. 275Vac. Courant de décharge maximal 10KA (8/20us). Courant de fonctionnement maximal 5A. Adapté pour les connexions en séries. IP66. Surge protection device. 275Vac. Maximum discharge current 10KA (8/20us). Maximum operating current 5A. Suitable for series connection. IP66. F990E00A000 116,00 €

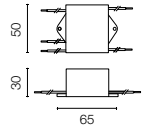

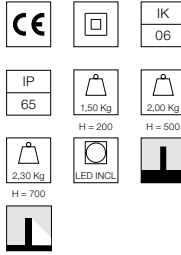
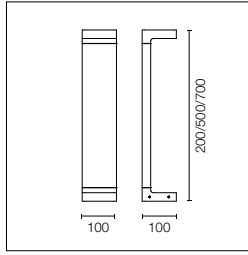

Alimentation 110/240V intégrée.

110/240V power supply integrated.

2200K disponible sur demande.

2200K available on request.

Power Led: 7W - 540 lm ≠ FIXT 272 lm - 2700K/CRI 80 - 110-240V / 7W - 585 lm ≠ FIXT 295 lm - 3000K/CRI 80 - 110-240V / 7W - 630 lm ≠ FIXT 317 lm - 4000K/CRI 80 - 110-240V

2700K

H 200 mm	
○ F1210001	336,00 €
● F1210006	336,00 €
● F1210012	336,00 €
● F1210018	336,00 €
● F1210030	336,00 €
● F1210033	336,00 €
H 500 mm	
○ F1213001	360,00 €
● F1213006	360,00 €
● F1213012	360,00 €
● F1213018	360,00 €
● F1213030	360,00 €
● F1213033	360,00 €
H 700 mm	
○ F1216001	422,00 €
● F1216006	422,00 €
● F1216012	422,00 €
● F1216018	422,00 €
● F1216030	422,00 €
● F1216033	422,00 €

3000K

H 200 mm	
○ F1211001	336,00 €
● F1211006	336,00 €
● F1211012	336,00 €
● F1211018	336,00 €
● F1211030	336,00 €
● F1211033	336,00 €
H 500 mm	
○ F1214001	360,00 €
● F1214006	360,00 €
● F1214012	360,00 €
● F1214018	360,00 €
● F1214030	360,00 €
● F1214033	360,00 €
H 700 mm	
○ F1217001	422,00 €
● F1217006	422,00 €
● F1217012	422,00 €
● F1217018	422,00 €
● F1217030	422,00 €
● F1217033	422,00 €

4000K

H 200 mm	
○ F1212001	336,00 €
● F1212006	336,00 €
● F1212012	336,00 €
● F1212018	336,00 €
● F1212030	336,00 €
● F1212033	336,00 €
H 500 mm	
○ F1215001	360,00 €
● F1215006	360,00 €
● F1215012	360,00 €
● F1215018	360,00 €
● F1215030	360,00 €
● F1215033	360,00 €
H 700 mm	
○ F1218001	422,00 €
● F1218006	422,00 €
● F1218012	422,00 €
● F1218018	422,00 €
● F1218030	422,00 €
● F1218033	422,00 €

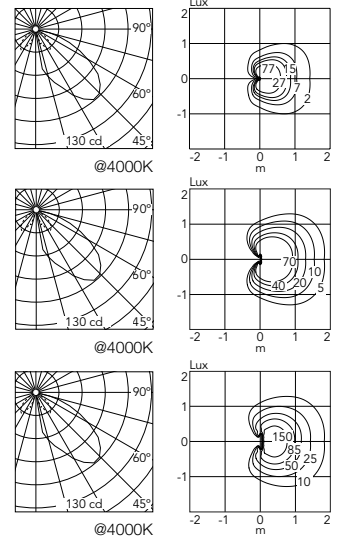

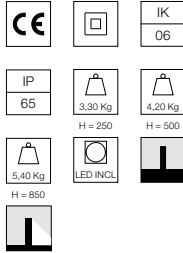
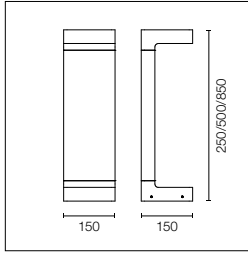

Alimentation 110/240V intégrée.

110/240V power supply integrated.

2200K disponible sur demande.

2200K available on request.

Power Led: 12W - 1080 lm ≠ FIXT 565 lm - 2700K/CRI 80 - 110-240V / 12W - 1170 lm ≠ FIXT 613 lm - 3000K/CRI 80 - 110-240V / 12W - 1260 lm ≠ FIXT 660 lm - 4000K/CRI 80 - 110-240V

2700K

H 250 mm - Non Dimmable

○ F1230001	465,00 €
● F1230006	465,00 €
● F1230012	465,00 €
● F1230018	465,00 €
● F1230030	465,00 €
● F1230033	465,00 €
1-10V	
○ F1230001-310	593,00 €
● F1230006-310	593,00 €
● F1230012-310	593,00 €
● F1230018-310	593,00 €
● F1230030-310	593,00 €
● F1230033-310	593,00 €
DALI	
○ F1230001-300	644,00 €
● F1230006-300	644,00 €
● F1230012-300	644,00 €
● F1230018-300	644,00 €
● F1230030-300	644,00 €
● F1230033-300	644,00 €

3000K

H 250 mm - Non Dimmable

○ F1231001	465,00 €
● F1231006	465,00 €
● F1231012	465,00 €
● F1231018	465,00 €
● F1231030	465,00 €
● F1231033	465,00 €
1-10V	
○ F1231001-310	593,00 €
● F1231006-310	593,00 €
● F1231012-310	593,00 €
● F1231018-310	593,00 €
● F1231030-310	593,00 €
● F1231033-310	593,00 €
DALI	
○ F1231001-300	644,00 €
● F1231006-300	644,00 €
● F1231012-300	644,00 €
● F1231018-300	644,00 €
● F1231030-300	644,00 €
● F1231033-300	644,00 €

4000K

H 250 mm - Non Dimmable

○ F1232001	465,00 €
● F1232006	465,00 €
● F1232012	465,00 €
● F1232018	465,00 €
● F1232030	465,00 €
● F1232033	465,00 €
1-10V	
○ F1232001-310	593,00 €
● F1232006-310	593,00 €
● F1232012-310	593,00 €
● F1232018-310	593,00 €
● F1232030-310	593,00 €
● F1232033-310	593,00 €
DALI	
○ F1232001-300	644,00 €
● F1232006-300	644,00 €
● F1232012-300	644,00 €
● F1232018-300	644,00 €
● F1232030-300	644,00 €
● F1232033-300	644,00 €

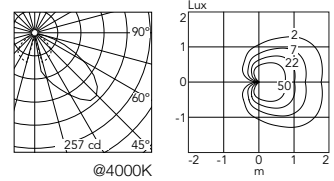

2700K

H 500 mm - Non Dimmable

○ F1233001	495,00 €
● F1233006	495,00 €
● F1233012	495,00 €
● F1233018	495,00 €
● F1233030	495,00 €
● F1233033	495,00 €
1-10V	
○ F1233001-310	627,00 €
● F1233006-310	627,00 €
● F1233012-310	627,00 €
● F1233018-310	627,00 €
● F1233030-310	627,00 €
● F1233033-310	627,00 €
DALI	
○ F1233001-300	675,00 €
● F1233006-300	675,00 €
● F1233012-300	675,00 €
● F1233018-300	675,00 €
● F1233030-300	675,00 €
● F1233033-300	675,00 €

3000K

H 500 mm - Non Dimmable

○ F1234001	495,00 €
● F1234006	495,00 €
● F1234012	495,00 €
● F1234018	495,00 €
● F1234030	495,00 €
● F1234033	495,00 €
1-10V	
○ F1234001-310	627,00 €
● F1234006-310	627,00 €
● F1234012-310	627,00 €
● F1234018-310	627,00 €
● F1234030-310	627,00 €
● F1234033-310	627,00 €
DALI	
○ F1234001-300	675,00 €
● F1234006-300	675,00 €
● F1234012-300	675,00 €
● F1234018-300	675,00 €
● F1234030-300	675,00 €
● F1234033-300	675,00 €

4000K

H 500 mm - Non Dimmable

○ F1235001	495,00 €
● F1235006	495,00 €
● F1235012	495,00 €
● F1235018	495,00 €
● F1235030	495,00 €
● F1235033	495,00 €
1-10V	
○ F1235001-310	627,00 €
● F1235006-310	627,00 €
● F1235012-310	627,00 €
● F1235018-310	627,00 €
● F1235030-310	627,00 €
● F1235033-310	627,00 €
DALI	
○ F1235001-300	675,00 €
● F1235006-300	675,00 €
● F1235012-300	675,00 €
● F1235018-300	675,00 €
● F1235030-300	675,00 €
● F1235033-300	675,00 €

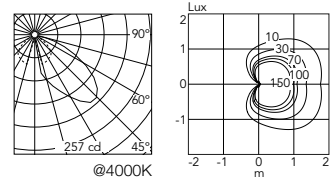

2700K

H 850 mm - Non Dimmable

○ F1236001	527,00 €
● F1236006	527,00 €
● F1236012	527,00 €
● F1236018	527,00 €
● F1236030	527,00 €
● F1236033	527,00 €
1-10V	
○ F1236001-310	656,00 €
● F1236006-310	656,00 €
● F1236012-310	656,00 €
● F1236018-310	656,00 €
● F1236030-310	656,00 €
● F1236033-310	656,00 €
DALI	
○ F1236001-300	705,00 €
● F1236006-300	705,00 €
● F1236012-300	705,00 €
● F1236018-300	705,00 €
● F1236030-300	705,00 €
● F1236033-300	705,00 €

3000K

H 850 mm - Non Dimmable

○ F1237001	527,00 €
● F1237006	527,00 €
● F1237012	527,00 €
● F1237018	527,00 €
● F1237030	527,00 €
● F1237033	527,00 €
1-10V	
○ F1237001-310	656,00 €
● F1237006-310	656,00 €
● F1237012-310	656,00 €
● F1237018-310	656,00 €
● F1237030-310	656,00 €
● F1237033-310	656,00 €
DALI	
○ F1237001-300	705,00 €
● F1237006-300	705,00 €
● F1237012-300	705,00 €
● F1237018-300	705,00 €
● F1237030-300	705,00 €
● F1237033-300	705,00 €

4000K

H 850 mm - Non Dimmable

○ F1238001	527,00 €
● F1238006	527,00 €
● F1238012	527,00 €
● F1238018	527,00 €
● F1238030	527,00 €
● F1238033	527,00 €
1-10V	
○ F1238001-310	656,00 €
● F1238006-310	656,00 €
● F1238012-310	656,00 €
● F1238018-310	656,00 €
● F1238030-310	656,00 €
● F1238033-310	656,00 €
DALI	
○ F1238001-300	705,00 €
● F1238006-300	705,00 €
● F1238012-300	705,00 €
● F1238018-300	705,00 €
● F1238030-300	705,00 €
● F1238033-300	705,00 €

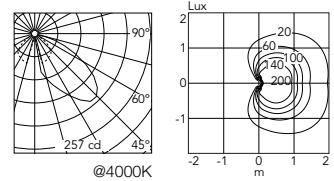

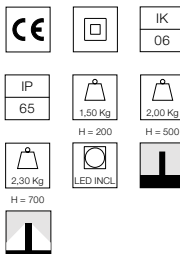
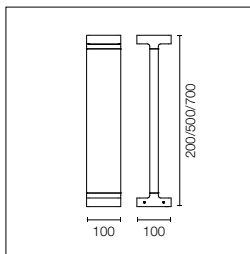

Alimentation 110/240V intégrée.

110/240V power supply integrated.

2200K disponible sur demande.

2200K available on request.

Power Led: 12W - 2x540 lm ≠ FIXT 2x272 lm - 2700K/CRI 80 - 110-240V / 12W - 2x585 lm ≠ FIXT 2x295 lm - 3000K/CRI 80 - 110-240V / 12W - 2x630 lm ≠ FIXT 2x317 lm - 4000K/CRI 80 - 110-240V

2700K

H 200 mm	
○ F1250001	403,00 €
● F1250006	403,00 €
● F1250012	403,00 €
● F1250018	403,00 €
● F1250030	403,00 €
● F1250033	403,00 €
H 500 mm	
○ F1253001	442,00 €
● F1253006	442,00 €
● F1253012	442,00 €
● F1253018	442,00 €
● F1253030	442,00 €
● F1253033	442,00 €
H 700 mm	
○ F1256001	502,00 €
● F1256006	502,00 €
● F1256012	502,00 €
● F1256018	502,00 €
● F1256030	502,00 €
● F1256033	502,00 €

3000K

H 200 mm	
○ F1251001	403,00 €
● F1251006	403,00 €
● F1251012	403,00 €
● F1251018	403,00 €
● F1251030	403,00 €
● F1251033	403,00 €
H 500 mm	
○ F1254001	442,00 €
● F1254006	442,00 €
● F1254012	442,00 €
● F1254018	442,00 €
● F1254030	442,00 €
● F1254033	442,00 €
H 700 mm	
○ F1257001	502,00 €
● F1257006	502,00 €
● F1257012	502,00 €
● F1257018	502,00 €
● F1257030	502,00 €
● F1257033	502,00 €

4000K

H 200 mm	
○ F1252001	403,00 €
● F1252006	403,00 €
● F1252012	403,00 €
● F1252018	403,00 €
● F1252030	403,00 €
● F1252033	403,00 €
H 500 mm	
○ F1255001	442,00 €
● F1255006	442,00 €
● F1255012	442,00 €
● F1255018	442,00 €
● F1255030	442,00 €
● F1255033	442,00 €
H 700 mm	
○ F1258001	502,00 €
● F1258006	502,00 €
● F1258012	502,00 €
● F1258018	502,00 €
● F1258030	502,00 €
● F1258033	502,00 €

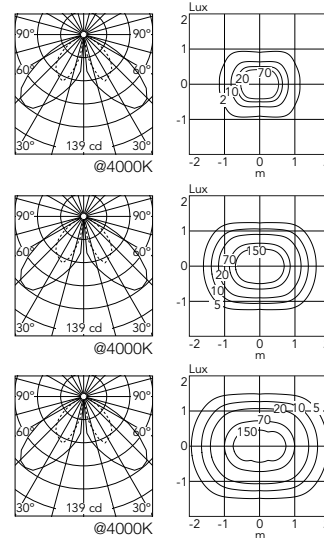

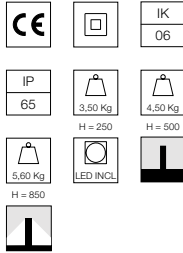
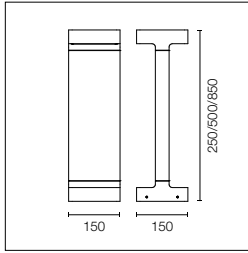

Alimentation 220/240V intégrée.
Version 110V sur demande.

220/240V power supply
integrated. Version 110V upon
request.

2200K disponible sur demande.

2200K available on request.

Power Led: 21W - 2x1080 lm ≠ FIXT 2x565 lm - 2700K/CRI 80 - 220-240V / 21W - 2x1170 lm ≠ FIXT 2x613 lm - 3000K/CRI 80 - 220-240V / 21W - 2x1260 lm ≠ FIXT 2x660 lm - 4000K/CRI 80 - 220-240V

2700K

H 250 mm - Non Dimmable

○ F1270001	564,00 €
● F1270006	564,00 €
● F1270012	564,00 €
● F1270018	564,00 €
● F1270030	564,00 €
● F1270033	564,00 €

○ F1270001-310	693,00 €
● F1270006-310	693,00 €
● F1270012-310	693,00 €
● F1270018-310	693,00 €
● F1270030-310	693,00 €
● F1270033-310	693,00 €

Dali

○ F1270001-300	742,00 €
● F1270006-300	742,00 €
● F1270012-300	742,00 €
● F1270018-300	742,00 €
● F1270030-300	742,00 €
● F1270033-300	742,00 €

2700K

H 500 mm - Non Dimmable

○ F1273001	599,00 €
● F1273006	599,00 €
● F1273012	599,00 €
● F1273018	599,00 €
● F1273030	599,00 €
● F1273033	599,00 €

○ F1273001-310	731,00 €
● F1273006-310	731,00 €
● F1273012-310	731,00 €
● F1273018-310	731,00 €
● F1273030-310	731,00 €
● F1273033-310	731,00 €

Dali

○ F1273001-300	779,00 €
● F1273006-300	779,00 €
● F1273012-300	779,00 €
● F1273018-300	779,00 €
● F1273030-300	779,00 €
● F1273033-300	779,00 €

2700K

H 850 mm - Non Dimmable

○ F1276001	620,00 €
● F1276006	620,00 €
● F1276012	620,00 €
● F1276018	620,00 €
● F1276030	620,00 €
● F1276033	620,00 €

○ F1276001-310	750,00 €
● F1276006-310	750,00 €
● F1276012-310	750,00 €
● F1276018-310	750,00 €
● F1276030-310	750,00 €
● F1276033-310	750,00 €

Dali

○ F1276001-300	797,00 €
● F1276006-300	797,00 €
● F1276012-300	797,00 €
● F1276018-300	797,00 €
● F1276030-300	797,00 €
● F1276033-300	797,00 €

3000K

H 250 mm - Non Dimmable

○ F1271001	564,00 €
● F1271006	564,00 €
● F1271012	564,00 €
● F1271018	564,00 €
● F1271030	564,00 €
● F1271033	564,00 €

○ F1271001-310	693,00 €
● F1271006-310	693,00 €
● F1271012-310	693,00 €
● F1271018-310	693,00 €
● F1271030-310	693,00 €
● F1271033-310	693,00 €

Dali

○ F1271001-300	742,00 €
● F1271006-300	742,00 €
● F1271012-300	742,00 €
● F1271018-300	742,00 €
● F1271030-300	742,00 €
● F1271033-300	742,00 €

3000K

H 500 mm - Non Dimmable

○ F1274001	599,00 €
● F1274006	599,00 €
● F1274012	599,00 €
● F1274018	599,00 €
● F1274030	599,00 €
● F1274033	599,00 €

○ F1274001-310	731,00 €
● F1274006-310	731,00 €
● F1274012-310	731,00 €
● F1274018-310	731,00 €
● F1274030-310	731,00 €
● F1274033-310	731,00 €

Dali

○ F1274001-300	779,00 €
● F1274006-300	779,00 €
● F1274012-300	779,00 €
● F1274018-300	779,00 €
● F1274030-300	779,00 €
● F1274033-300	779,00 €

3000K

H 850 mm - Non Dimmable

○ F1277001	620,00 €
● F1277006	620,00 €
● F1277012	620,00 €
● F1277018	620,00 €
● F1277030	620,00 €
● F1277033	620,00 €

○ F1277001-310	750,00 €
● F1277006-310	750,00 €
● F1277012-310	750,00 €
● F1277018-310	750,00 €
● F1277030-310	750,00 €
● F1277033-310	750,00 €

Dali

○ F1277001-300	797,00 €
● F1277006-300	797,00 €
● F1277012-300	797,00 €
● F1277018-300	797,00 €
● F1277030-300	797,00 €
● F1277033-300	797,00 €

4000K

H 250 mm - Non Dimmable

○ F1272001	564,00 €
● F1272006	564,00 €
● F1272012	564,00 €
● F1272018	564,00 €
● F1272030	564,00 €
● F1272033	564,00 €

○ F1272001-310	693,00 €
● F1272006-310	693,00 €
● F1272012-310	693,00 €
● F1272018-310	693,00 €
● F1272030-310	693,00 €
● F1272033-310	693,00 €

Dali

○ F1272001-300	742,00 €
● F1272006-300	742,00 €
● F1272012-300	742,00 €
● F1272018-300	742,00 €
● F1272030-300	742,00 €
● F1272033-300	742,00 €

4000K

H 500 mm - Non Dimmable

○ F1275001	599,00 €
● F1275006	599,00 €
● F1275012	599,00 €
● F1275018	599,00 €
● F1275030	599,00 €
● F1275033	599,00 €

○ F1275001-310	731,00 €
● F1275006-310	731,00 €
● F1275012-310	731,00 €
● F1275018-310	731,00 €
● F1275030-310	731,00 €
● F1275033-310	731,00 €

Dali

○ F1275001-300	779,00 €
● F1275006-300	779,00 €
● F1275012-300	779,00 €
● F1275018-300	779,00 €
● F1275030-300	779,00 €
● F1275033-300	779,00 €

4000K

H 850 mm - Non Dimmable

○ F1278001	620,00 €
● F1278006	620,00 €
● F1278012	620,00 €
● F1278018	620,00 €
● F1278030	620,00 €
● F1278033	620,00 €

○ F1278001-310	750,00 €
● F1278006-310	750,00 €
● F1278012-310	750,00 €
● F1278018-310	750,00 €
● F1278030-310	750,00 €
● F1278033-310	750,00 €

Dali

○ F1278001-300	797,00 €
● F1278006-300	797,00 €
● F1278012-300	797,00 €
● F1278018-300	797,00 €
● F1278030-300	797,00 €
● F1278033-300	797,00 €

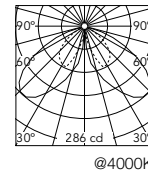

@4000K

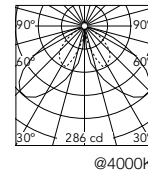
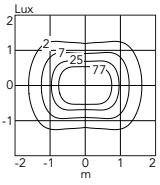

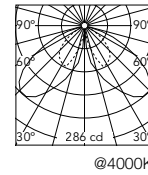
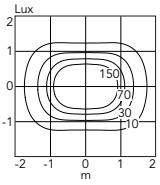

@4000K

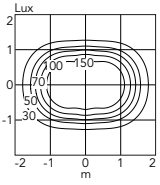

@4000K

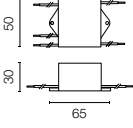

Casting T/C: Accessoires / Accessories

Plaque de boulons.	Base plate with bolt.	Casting 100	36,00 €	
		F1208000		
		Casting 150	36,00 €	
		F1207000		
Système de jonction IP68 H2O Stop anti-condensation à 3/4 voies 4 pôles. (Ø5,5÷12mm câble).	3/4 way terminal block 4 poles IP68 H2O Stop. (ø5,5÷12mm cable).	F990C010000	60,00 €	
Dispositif de protection contre les surtensions. 275Vac. Courant de décharge maximal 10KA (8/20us). Courant de fonctionnement maximal 5A. Adapté pour les connexions en séries. IP66.	Surge protection device. 275Vac. Maximum discharge current 10KA (8/20us). Maximum operating current 5A. Suitable for series connection. IP66.	F990E00A000	116,00 €	 

Walkstick / Wallstick

Designed by Antonio Citterio





Walkstick 2 Double



Walkstick Pipe

Famille / Family

Walkstick



Power Led

2,5W
185 lm - 2700K/CRI 80
199 lm - 3000K/CRI 80
212 lm - 4000K/CRI 80
[2200K available on request.](#)

Walkstick Pipe



Power Led

7W
483 lm - 2700K/CRI 80
496 lm - 3000K/CRI 80
529 lm - 4000K/CRI 80
[2200K available on request.](#)

Walkstick



Power Led

6W
333 lm - 2700K/CRI 80
358 lm - 3000K/CRI 80
382 lm - 4000K/CRI 80
[2200K available on request.](#)

Walkstick Double



Power Led

8,5W
333+185 lm - 2700K/CRI 80
358+199 lm - 3000K/CRI 80
382+212 lm - 4000K/CRI 80
[2200K available on request.](#)

Finitions / Colours



01 White



06 Grey

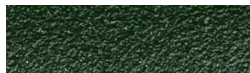

12 Forest Green



18 Deep Brown



30 Black



33 Anthracite

Description

Walkstick Pipe

Collection de lampes sur mâts pour l'extérieur avec source lumineuse à LED et tête tubulaire orientable à 350° sur l'axe vertical et 350° sur l'axe horizontal. Disponible en deux hauteurs.

Le mât et la tête sont en aluminium extrudé, la base est en aluminium moulé sous pression à faible teneur en cuivre.

Disponible en différentes finitions avec une peinture à poudres double couche selon la norme QUALICOAT. La première couche de poudres époxy offre une résistance chimique et mécanique, la seconde couche de finition de poudres polyester garantit une résistance aux rayons UV et aux agents atmosphériques corrosifs. Les surfaces peintes sont traitées par lavages alcalins et acides, rincées à l'eau déminéralisée puis soumises à un traitement de conversion chimique de protection contre l'oxydation.

Les vis de fixation sont en acier inox AISI 316L.

Diffuseur en verre acidifié qui garantit une diffusion uniforme de la lumière au sol.

L'appareil est équipé d'un câble sortant en néoprène.

Il peut être facilement installé sur tous les sols avec des ancrages, ou en utilisant le boîtier qui rend la base du produit totalement solidaire du sol.

Walkstick

Collection de lampes sur mât pour l'extérieur avec source lumineuse à LED et tête évasée orientable à 350° sur l'axe vertical. Disponible en deux hauteurs associées aux versions avec une ou deux lampes.

Le mât est en aluminium extrudé, la base et la tête sont en aluminium moulé sous pression EN AB-47100 à faible teneur en cuivre.

Disponible en différentes finitions avec une peinture à poudres double couche selon la norme QUALICOAT. La première couche de poudres époxy offre une résistance chimique et mécanique, la seconde couche de finition de poudres polyester garantit une résistance aux rayons UV et aux agents atmosphériques corrosifs. Les surfaces peintes sont traitées par lavages alcalins et acides, rincées à l'eau déminéralisée puis soumises à un traitement de conversion chimique de protection contre l'oxydation.

Les vis de fixation sont en acier inox AISI 316L.

Diffuseur en verre micro texturé pour garantir une distribution homogène de la lumière au sol.

L'appareil peut être facilement installé sur tous les sols avec des ancrages, ou en utilisant le boîtier qui rend la base du produit totalement solidaire du sol.

Wallstick

Applique murale de balisage pour l'extérieur avec source lumineuse à LED et tête évasée orientable à 350° sur l'axe vertical. Le corps de l'appareil est en aluminium moulé sous pression à faible teneur en cuivre.

Disponible en différentes finitions avec une peinture à poudres double couche selon la norme QUALICOAT. La première couche de poudres époxy offre une résistance chimique et mécanique, la seconde couche de finition de poudres polyester garantit une résistance aux rayons UV et aux agents atmosphériques corrosifs. Les surfaces peintes sont traitées par lavages alcalins et acides, rincées à l'eau déminéralisée puis soumises à un traitement de conversion chimique de protection contre l'oxydation.

Les vis de fixation sont en acier inox AISI 316L.

Diffuseur en verre micro texturé pour garantir une distribution homogène de la lumière au sol.

L'appareil est équipé de deux câbles d'alimentation sortant L. 200 mm et d'un kit pour une connexion étanche.

L'alimentation électrique en 24V peut être installée à distance. Le boîtier (boîte de dérivation à 3 modules modèle 503) disponible en option, permet une plus grande facilité d'installation.

Description

Walkstick Pipe

Collection of outdoor poles with LED light source and tubular head that can be adjusted 350° on the vertical and horizontal axes. Available in two different heights.

The stem and head are made of extruded aluminium; the base is made of die-cast aluminium with low copper content.

Available in different finishes with a double layer of powder coating according to the QUALICOAT standard. The first layer of epoxy powder confers chemical and mechanical resistance. The second layer, a polyester powder finish, ensures resistance to UV rays and corrosive atmospheric agents. The painted surfaces are treated with alkiline and acid washes, rinsed with demineralized water, and subjected to chemical conversion treatment to protect against rust.

The anchoring hardware is made of AISI 316L stainless steel.

Diffuser made of acid-etched glass to guarantee a uniform wash of light on the ground.

The unit is supplied with a length of neoprene cable.

The unit may be easily installed on any flooring on the ground with anchors, or with the dedicated installation box to completely integrate the base of the product with the pavement.

Walkstick

Collection of outdoor poles with LED light source and tubular head that can be adjusted vertically 350°. Available in two different heights combined with the one- or two-light version.

The stem is made of extruded aluminium; the base and head are made of EN AB-47100 die-cast aluminium with low copper content.

Available in different finishes with a double layer of powder coating according to the QUALICOAT standard. The first layer of epoxy powder confers chemical and mechanical resistance. The second layer, a polyester powder finish, ensures resistance to UV rays and corrosive atmospheric agents. The painted surfaces are treated with alkiline and acid washes, rinsed with demineralized water, and subjected to chemical conversion treatment to protect against rust.

The anchoring hardware is made of AISI 316L stainless steel.

Diffuser in micro-textured glass to guarantee uniform light distribution on the ground.

The unit may be easily installed on any flooring on the ground with anchors, or with the dedicated installation box to completely integrate the base of the product with the pavement.

Wallstick

Wall-mounted outdoor footpath lights with LED light source and flared head that can be adjusted vertically 350°. The body is made of die-cast aluminium with low copper content.

Available in different finishes with a double layer of powder coating according to the QUALICOAT standard. The first layer of epoxy powder confers chemical and mechanical resistance. The second layer, a polyester powder finish, ensures resistance to UV rays and corrosive atmospheric agents. The painted surfaces are treated with alkiline and acid washes, rinsed with demineralized water, and subjected to chemical conversion treatment to protect against rust.

The anchoring hardware is made of AISI 316L stainless steel. Diffuser in micro-textured glass to guarantee uniform light distribution on the ground.

The light comes with two 2-m power cables and with a kit for IP-rated connection.

The 24V electrical power supply can be installed remotely. For easier installation, an optional box (sold separately) is available (3-module junction box, model 503).

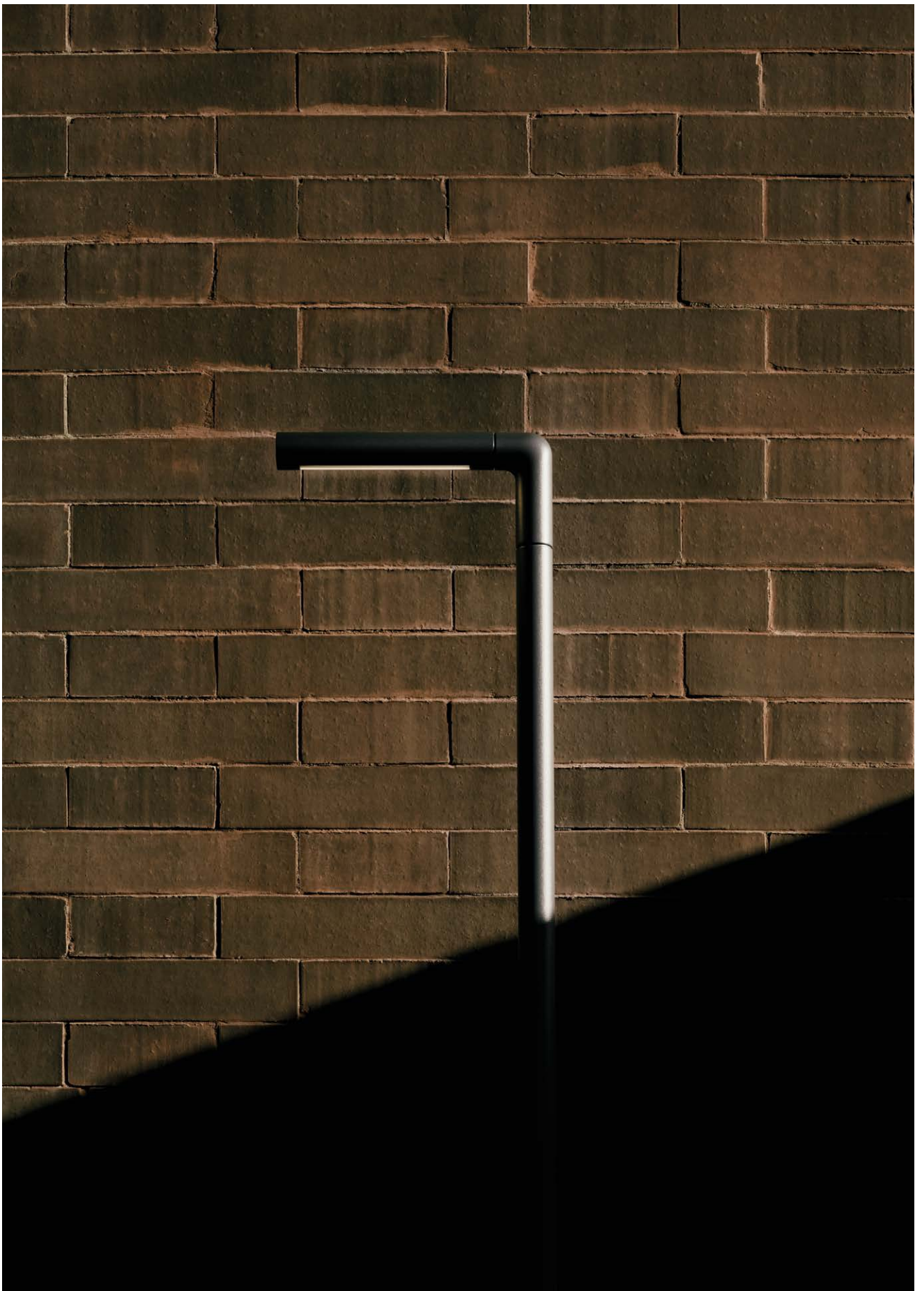

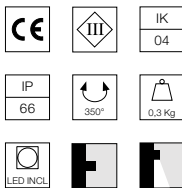
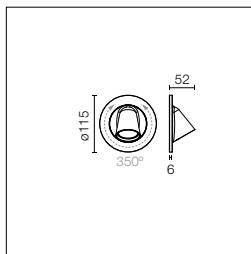

Source lumineuse LED incluse.
Tête orientable à 350° sur l'axe vertical. Alimentation électrique 24V à distance à commander séparément. Appareil fourni avec deux câbles d'alimentation sortants L.200mm et un kit de connexion étanche. L'alimentation peut être installée à distance (sans boîtier) ou une fois l'appareil installé, à l'aide d'un coffrage en option.

LED light source included. Head adjustable 350° on the vertical axis. Remote 24V electrical power unit sold separately. Unit comes with two 200-mm-long outgoing power cables and a kit for IP-rated connection. The power supply may be installed remotely (installation box not necessary) or housed behind the unit with the optional installation box.

2200K disponible sur demande.

2200K available on request.

Power Led: 2,5W - 264 lm ≠ FIXT 185 lm - 2700K/CRI 80 - 24V / 2,5W - 283 lm ≠ FIXT 199 lm - 3000K/CRI 80 - 24V / 2,5W - 303 lm ≠ FIXT 212 lm - 4000K/CRI 80 - 24V

2700K

PWM Dimmable

- F010A20H001 217,00 €
- F010A20H006 217,00 €
- F010A20H012 217,00 €
- F010A20H018 217,00 €
- F010A20H030 217,00 €
- F010A20H033 217,00 €

3000K

PWM Dimmable

- F010A30H001 217,00 €
- F010A30H006 217,00 €
- F010A30H012 217,00 €
- F010A30H018 217,00 €
- F010A30H030 217,00 €
- F010A30H033 217,00 €

4000K

PWM Dimmable

- F010A40H001 217,00 €
- F010A40H006 217,00 €
- F010A40H012 217,00 €
- F010A40H018 217,00 €
- F010A40H030 217,00 €
- F010A40H033 217,00 €

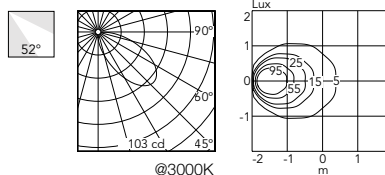

* Nombre maximum de luminaires par source d'alimentation / Maximum number of luminaires per power supply.

Nombre maximum de luminaires par source d'alimentation (220÷240 V). Ces données doivent être vérifiées en prenant en compte les conditions spécifiques d'installation.

Maximum number of luminaires per power supply. (220÷240 V). These data must be checked taking into account the specific installation conditions.

Non Dimmable

Acc. RF25754	1
Acc. RF25748	1
Acc. RF25747	2
Acc. RF25757	2
Acc. F990B23AZ00	7
Acc. F990B28A000	9
Acc. F990B27A000	13

Dimmable

Acc. F990B02A000	7
Acc. F990B03A000	7
Acc. F990B16A000	7
Acc. F990B04A000	13
Acc. F990B05A000	13
Acc. F990B17A000	13

Fixation au Mur / Installation on Wall

Option 1

Sans boîtier de réservation / Without recessed box installation.

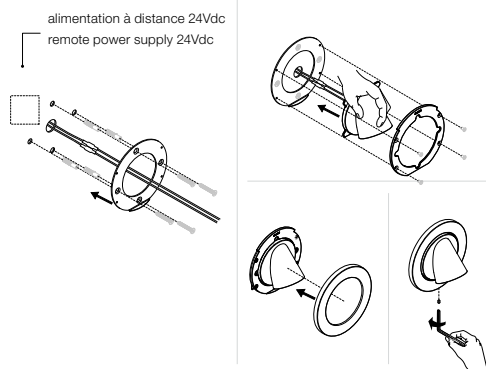

Option 2

Boîtier de réservation encastré / Recessed box installation

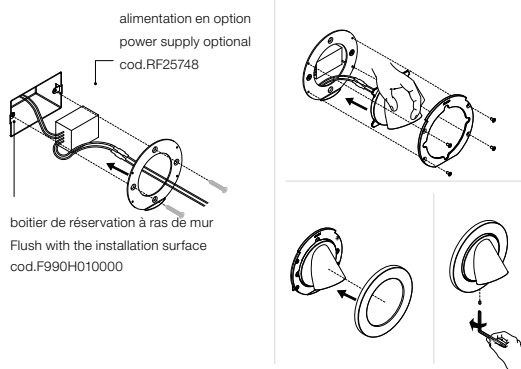

Wallstick: Accessoires / Accessories

Boîtier de dérivation à encastrer 3 modules (modèle 503) 106x75mm H55mm.

Recessed 3-module junction box (model 503) 106 mm x 75 mm H 55 mm.

F990H010000 12,00 €

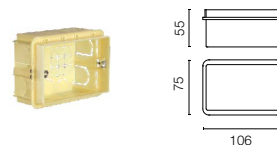

Système de jonction IP68 à 2 voies 2 pôles. (Ø4÷6,9mm câble).

2 way terminal block 2 poles IP68. (Ø4÷6,9mm cable).





F990C050000 34,00 €

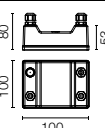
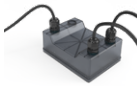
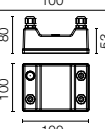
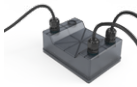
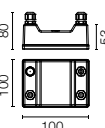
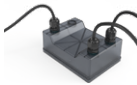
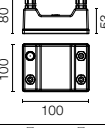

Il ne peut pas être placé dans le boîtier encastré pour l'installation.

It can't be placed in the recessed box for installation.

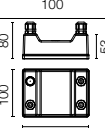
Wallstick: Power Supply Dimmable

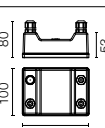
Alimentation 24V PWM avec interface de contrôle 1-10V IP67 Classe II. Vin 120-270 Vac.	Power supply 24V PWM with 1-10V control interface IP67 Class II. Vin 120-270 Vac.	35W	350,00 €		
		*F990B02A000			
		70W	404,00 €		
		*F990B04A000			
Alimentation 24V PWM avec interface de contrôle 1-10V IP67 Classe II. Vin 120-270 Vac.	Power supply 24V PWM with 1-10V control interface IP67 Class II. Vin 120-270 Vac.	35W	350,00 €		
		*F990B03A000			
		70W	404,00 €		
		*F990B05A000			
Alimentation 24V PWM avec interface de contrôle PUSH IP67 Classe II. Vin 120-270 Vac.	Power supply 24v PWM with PUSH control interface IP67 Class II. Vin 120-270 Vac.	35W	350,00 €		
		*F990B16A000			
		70W	404,00 €		
		*F990B17A000			
Interface de contrôle 24V PWM - 1-10V IP67 Class III. Vin 24Vdc 120W (Alimentation non comprise).	Control interface 24V PWM - 1-10V IP67 Class III. Vin 24Vdc 120W (Power supply not included).	F990B00A000	208,00 €		
Interface de contrôle 24V PWM - Dali IP67 Class III. Vin 24Vdc 120W (Alimentation non comprise).	Control interface 24V PWM - Dali IP67 Class III. Vin 24Vdc 120W (Power supply not included).	F990B01A000	208,00 €		
Interface de contrôle 24V PWM - Push IP67 Class III. Vin 24Vdc 120W (Alimentation non comprise).	Control interface 24V PWM - Push IP67 Class III. Vin 24Vdc 120W (Power supply not included).	F990B18A000	208,00 €		

Wallstick: Power Supply Non Dimmable

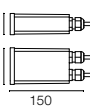
Équipement d'alimentation 24V 8W / 110-240V IP20 Classe II selv.	Power supply 24V 8W / 110-240V IP20 Class II selv.	*RF25754	36,00 €		
Équipement d'alimentation 24V 8W / 110-240V IP65 Classe II selv.	Power supply 24V 8W / 110-240V IP65 Class II selv.	*RF25748	63,00 €		
Équipement d'alimentation 24V 10W / 110-240V IP20 Classe II selv.	Power supply 24V 10W / 110-240V IP20 Class II selv.	*RF25747	48,00 €		
Équipement d'alimentation 24V 10W / 110-240V IP67 Classe II selv.	Power supply 24V 10W / 110-240V IP67 Class II selv.	*RF25757	86,00 €		
Alimentation 24Vdc 35W / 120-270V IP67 Class II selv.	Power supply 24Vdc 35W / 120-270V IP67 Class II selv.	*F990B23AZ00	180,00 €		
Équipement d'alimentation 24Vdc 50W / 120-240V IP67 Classe II selv.	Power supply 24Vdc 50W / 120-240V IP67 Class II selv.	*F990B28A000	251,00 €		
Équipement d'alimentation 24Vdc 70W / 220-240V IP67 Classe II selv.	Power supply 24Vdc 70W / 220-240V IP67 Class II selv.	*F990B27A000	212,00 €		

Walkstick Pipe 1

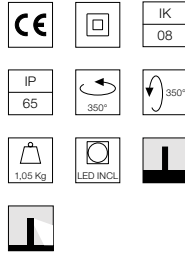
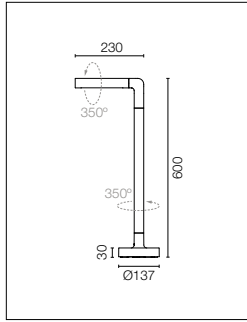

Alimentation 220-240V comprise. Pour installation sur base rigide. Boîtier pour installation dans le sol à commander séparément. Inclut un système de jonction IP68 H₂O Stop anti-condensation à 2 voies 4 pôles. Version 110V sur demande.

220-240V power supply included. Ready for installation on solid surface. Box for ground installation to be ordered separately. Included 2 way terminal block 4 poles IP68 H₂O Stop. Version 110V upon request.

2200K disponible sur demande.

2200K available on request.

Power Led: 7W - 622 lm ≠ FIXT 483 lm - 2700K/CRI 80 - 220-240V / 7W - 648 lm ≠ FIXT 496 lm - 3000K/CRI 80 - 220-240V / 7W - 693 lm ≠ FIXT 529 lm - 4000K/CRI 80 - 220-240V

2700K

Non Dimmable

○ F010H21A001	555,00 €
● F010H21A006	555,00 €
● F010H21A012	555,00 €
● F010H21A018	555,00 €
● F010H21A030	555,00 €
● F010H21A033	555,00 €
1-10V	
○ F010H21B001	614,00 €
● F010H21B006	614,00 €
● F010H21B012	614,00 €
● F010H21B018	614,00 €
● F010H21B030	614,00 €
● F010H21B033	614,00 €

3000K

Non Dimmable

○ F010H31A001	555,00 €
● F010H31A006	555,00 €
● F010H31A012	555,00 €
● F010H31A018	555,00 €
● F010H31A030	555,00 €
● F010H31A033	555,00 €
1-10V	
○ F010H31B001	614,00 €
● F010H31B006	614,00 €
● F010H31B012	614,00 €
● F010H31B018	614,00 €
● F010H31B030	614,00 €
● F010H31B033	614,00 €

4000K

Non Dimmable

○ F010H41A001	555,00 €
● F010H41A006	555,00 €
● F010H41A012	555,00 €
● F010H41A018	555,00 €
● F010H41A030	555,00 €
● F010H41A033	555,00 €
1-10V	
○ F010H41B001	614,00 €
● F010H41B006	614,00 €
● F010H41B012	614,00 €
● F010H41B018	614,00 €
● F010H41B030	614,00 €
● F010H41B033	614,00 €

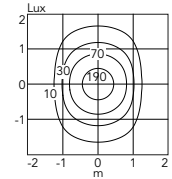
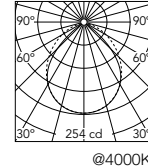

Walkstick Pipe 2

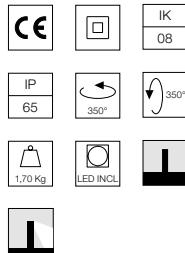
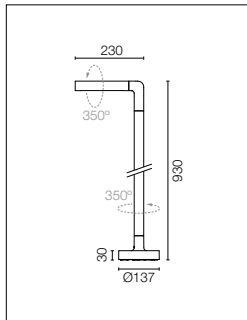

Alimentation 220-240V comprise. Pour installation sur base rigide. Boîtier pour installation dans le sol à commander séparément. Inclut un système de jonction IP68 H₂O Stop anti-condensation à 2 voies 4 pôles. Version 110V sur demande.

220-240V power supply included. Ready for installation on solid surface. Box for ground installation to be ordered separately. Included 2 way terminal block 4 poles IP68 H₂O Stop. Version 110V upon request.

2200K disponible sur demande.

2200K available on request.

Power Led: 7W - 622 lm ≠ FIXT 483 lm - 2700K/CRI 80 - 220-240V / 7W - 648 lm ≠ FIXT 496 lm - 3000K/CRI 80 - 220-240V / 7W - 693 lm ≠ FIXT 529 lm - 4000K/CRI 80 - 220-240V

2700K

Non Dimmable

○ F010J21A001	566,00 €
● F010J21A006	566,00 €
● F010J21A012	566,00 €
● F010J21A018	566,00 €
● F010J21A030	566,00 €
● F010J21A033	566,00 €
1-10V	
○ F010J21B001	625,00 €
● F010J21B006	625,00 €
● F010J21B012	625,00 €
● F010J21B018	625,00 €
● F010J21B030	625,00 €
● F010J21B033	625,00 €
Dali	
○ F010J21D001	672,00 €
● F010J21D006	672,00 €
● F010J21D012	672,00 €
● F010J21D018	672,00 €
● F010J21D030	672,00 €
● F010J21D033	672,00 €

3000K

Non Dimmable

○ F010J31A001	566,00 €
● F010J31A006	566,00 €
● F010J31A012	566,00 €
● F010J31A018	566,00 €
● F010J31A030	566,00 €
● F010J31A033	566,00 €
1-10V	
○ F010J31B001	625,00 €
● F010J31B006	625,00 €
● F010J31B012	625,00 €
● F010J31B018	625,00 €
● F010J31B030	625,00 €
● F010J31B033	625,00 €
Dali	
○ F010J31D001	672,00 €
● F010J31D006	672,00 €
● F010J31D012	672,00 €
● F010J31D018	672,00 €
● F010J31D030	672,00 €
● F010J31D033	672,00 €

4000K

Non Dimmable

○ F010J41A001	566,00 €
● F010J41A006	566,00 €
● F010J41A012	566,00 €
● F010J41A018	566,00 €
● F010J41A030	566,00 €
● F010J41A033	566,00 €
1-10V	
○ F010J41B001	625,00 €
● F010J41B006	625,00 €
● F010J41B012	625,00 €
● F010J41B018	625,00 €
● F010J41B030	625,00 €
● F010J41B033	625,00 €
Dali	
○ F010J41D001	672,00 €
● F010J41D006	672,00 €
● F010J41D012	672,00 €
● F010J41D018	672,00 €
● F010J41D030	672,00 €
● F010J41D033	672,00 €

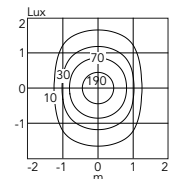
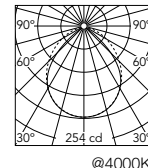

Walkstick 1

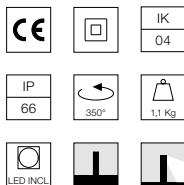
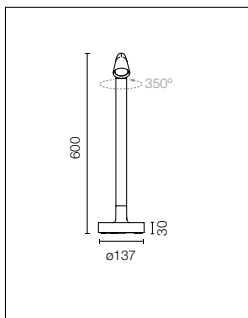

Source lumineuse LED incluse.
Tête orientable à 350° sur l'axe vertical et 350° sur l'axe horizontal. Alimentation électrique 220-240V ON/OFF variable 1-10V ou DALI intégrée. Equipé d'un morceau de câble sortant en néoprène et d'un système avec joint anti-condensation IP68 H₂O à 2 voies. Boîtier d'installation au sol à commander séparément. Version 110V sur demande.

LED light source included. Head adjustable 350° on both the vertical and horizontal axes. Integrated 220-240V ON/OFF electrical power. Equipped with a length of neoprene cable and an IP68 2-way anti-condensation H₂O stop seal system. Box for ground installation sold separately. 110V version by request.

2200K disponible sur demande.

2200K available on request.

Power Led: 6W - 502 lm ≠ FIXT 333 lm - 2700K/CRI 80 - 220-240V / 6W - 539 lm ≠ FIXT 358 lm - 3000K/CRI 80 - 220-240V / 6W - 577 lm ≠ FIXT 382 lm - 4000K/CRI 80 - 220-240V

2700K

Non Dimmable

○ F010B21A001	495,00 €
● F010B21A006	495,00 €
● F010B21A012	495,00 €
● F010B21A018	495,00 €
● F010B21A030	495,00 €
● F010B21A033	495,00 €

1-10V

○ F010B21B001	555,00 €
● F010B21B006	555,00 €
● F010B21B012	555,00 €
● F010B21B018	555,00 €
● F010B21B030	555,00 €
● F010B21B033	555,00 €

3000K

Non Dimmable

○ F010B31A001	495,00 €
● F010B31A006	495,00 €
● F010B31A012	495,00 €
● F010B31A018	495,00 €
● F010B31A030	495,00 €
● F010B31A033	495,00 €

1-10V

○ F010B31B001	555,00 €
● F010B31B006	555,00 €
● F010B31B012	555,00 €
● F010B31B018	555,00 €
● F010B31B030	555,00 €
● F010B31B033	555,00 €

4000K

Non Dimmable

○ F010B41A001	495,00 €
● F010B41A006	495,00 €
● F010B41A012	495,00 €
● F010B41A018	495,00 €
● F010B41A030	495,00 €
● F010B41A033	495,00 €

1-10V

○ F010B41B001	555,00 €
● F010B41B006	555,00 €
● F010B41B012	555,00 €
● F010B41B018	555,00 €
● F010B41B030	555,00 €
● F010B41B033	555,00 €

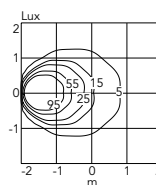
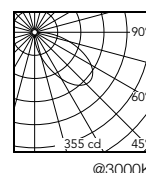

Walkstick 2

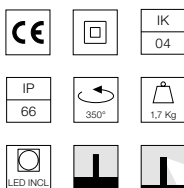
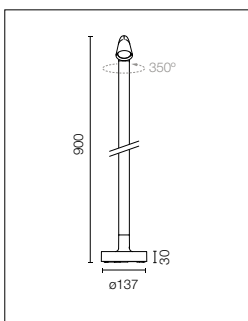

Source lumineuse LED incluse.
Tête orientable à 350° sur l'axe vertical et 350° sur l'axe horizontal. Alimentation électrique 220-240V ON/OFF variable 1-10V ou DALI intégrée. Equipé d'un morceau de câble sortant en néoprène et d'un système avec joint anti-condensation IP68 H₂O à 2 voies. Boîtier d'installation au sol à commander séparément. Version 110V sur demande.

LED light source included. Head adjustable 350° on both the vertical and horizontal axes. Integrated 220-240V ON/OFF and 1-10V or DALI dimmable electrical power. Equipped with a length of neoprene cable and an IP68 2-way anti-condensation H₂O stop seal system. Box for ground installation sold separately. 110V version by request.

2200K disponible sur demande.

2200K available on request.

Power Led: 6W - 502 lm ≠ FIXT 333 lm - 2700K/CRI 80 - 220-240V / 6W - 539 lm ≠ FIXT 358 lm - 3000K/CRI 80 - 220-240V / 6W - 577 lm ≠ FIXT 382 lm - 4000K/CRI 80 - 220-240V

2700K

Non Dimmable

○ F010B22A001	526,00 €
● F010B22A006	526,00 €
● F010B22A012	526,00 €
● F010B22A018	526,00 €
● F010B22A030	526,00 €
● F010B22A033	526,00 €

1-10V

○ F010B22B001	584,00 €
● F010B22B006	584,00 €
● F010B22B012	584,00 €
● F010B22B018	584,00 €
● F010B22B030	584,00 €
● F010B22B033	584,00 €

Dali

○ F010B22D001	631,00 €
● F010B22D006	631,00 €
● F010B22D012	631,00 €
● F010B22D018	631,00 €
● F010B22D030	631,00 €
● F010B22D033	631,00 €

3000K

Non Dimmable

○ F010B32A001	526,00 €
● F010B32A006	526,00 €
● F010B32A012	526,00 €
● F010B32A018	526,00 €
● F010B32A030	526,00 €
● F010B32A033	526,00 €

1-10V

○ F010B32B001	584,00 €
● F010B32B006	584,00 €
● F010B32B012	584,00 €
● F010B32B018	584,00 €
● F010B32B030	584,00 €
● F010B32B033	584,00 €

Dali

○ F010B32D001	631,00 €
● F010B32D006	631,00 €
● F010B32D012	631,00 €
● F010B32D018	631,00 €
● F010B32D030	631,00 €
● F010B32D033	631,00 €

4000K

Non Dimmable

○ F010B42A001	526,00 €
● F010B42A006	526,00 €
● F010B42A012	526,00 €
● F010B42A018	526,00 €
● F010B42A030	526,00 €
● F010B42A033	526,00 €

1-10V

○ F010B42B001	584,00 €
● F010B42B006	584,00 €
● F010B42B012	584,00 €
● F010B42B018	584,00 €
● F010B42B030	584,00 €
● F010B42B033	584,00 €

Dali

○ F010B42D001	631,00 €
● F010B42D006	631,00 €
● F010B42D012	631,00 €
● F010B42D018	631,00 €
● F010B42D030	631,00 €
● F010B42D033	631,00 €

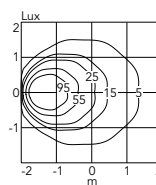
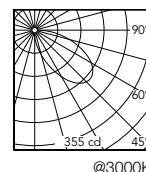

Walkstick 2 Double

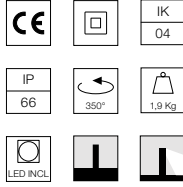
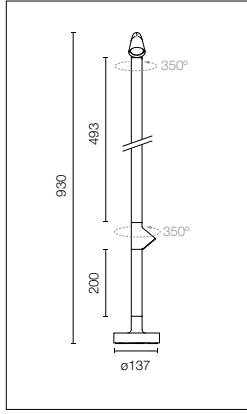

Double source lumineuse LED incluse. Tête orientable indépendamment à 350° sur l'axe vertical et 350° sur l'axe horizontal. Alimentation électrique 220-240V ON/OFF variable 1-10V ou DALI intégrée. Equipé d'un morceau de câble sortant en néoprène et d'un système avec joint anti-condensation IP68 H₂O à 2 voies. Boîtier d'installation au sol à commander séparément. Version 110V sur demande

Dual LED light source included. Heads independently adjustable 350° on both the vertical and horizontal axes. Integrated 220-240V ON/OFF and 1-10V or DALI dimmable electrical power. Equipped with a length of neoprene cable and an IP68 2-way anti-condensation H₂O stop seal system. Box for ground installation sold separately. 110V version by request.

2200K disponible sur demande.

2200K available on request.

Power Led: 8,5W - 502+264 lm ≠ FIXT 333+185 lm - 2700K/CRI 80 - 220-240V / 8,5W - 539+283 lm ≠ FIXT 358+199 lm - 3000K/CRI 80 - 220-240V / 8,5W - 577+303 lm ≠ FIXT 382+212 lm - 4000K/CRI 80 - 220-240V

2700K

Non Dimmable	
○ F010C22A001	625,00 €
● F010C22A006	625,00 €
● F010C22A012	625,00 €
● F010C22A018	625,00 €
● F010C22A030	625,00 €
● F010C22A033	625,00 €
1-10V	
○ F010C22B001	684,00 €
● F010C22B006	684,00 €
● F010C22B012	684,00 €
● F010C22B018	684,00 €
● F010C22B030	684,00 €
● F010C22B033	684,00 €
Dali	
○ F010C22D001	731,00 €
● F010C22D006	731,00 €
● F010C22D012	731,00 €
● F010C22D018	731,00 €
● F010C22D030	731,00 €
● F010C22D033	731,00 €

3000K

Non Dimmable	
○ F010C32A001	625,00 €
● F010C32A006	625,00 €
● F010C32A012	625,00 €
● F010C32A018	625,00 €
● F010C32A030	625,00 €
● F010C32A033	625,00 €
1-10V	
○ F010C32B001	684,00 €
● F010C32B006	684,00 €
● F010C32B012	684,00 €
● F010C32B018	684,00 €
● F010C32B030	684,00 €
● F010C32B033	684,00 €
Dali	
○ F010C32D001	731,00 €
● F010C32D006	731,00 €
● F010C32D012	731,00 €
● F010C32D018	731,00 €
● F010C32D030	731,00 €
● F010C32D033	731,00 €

4000K

Non Dimmable	
○ F010C42A001	625,00 €
● F010C42A006	625,00 €
● F010C42A012	625,00 €
● F010C42A018	625,00 €
● F010C42A030	625,00 €
● F010C42A033	625,00 €
1-10V	
○ F010C42B001	684,00 €
● F010C42B006	684,00 €
● F010C42B012	684,00 €
● F010C42B018	684,00 €
● F010C42B030	684,00 €
● F010C42B033	684,00 €
Dali	
○ F010C42D001	731,00 €
● F010C42D006	731,00 €
● F010C42D012	731,00 €
● F010C42D018	731,00 €
● F010C42D030	731,00 €
● F010C42D033	731,00 €

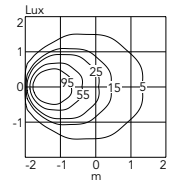
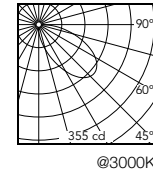

Walkstick: Accessoires / Accessories

Boitier pour installation au sol.

Box for ground installation.

F001Z020000

61,00 €

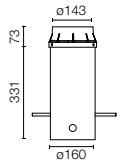

Dispositif de protection contre les surtensions. 275Vac. Courant de décharge maximal 10KA (8/20us). Courant de fonctionnement maximal 5A. Adapté pour les connexions en séries. IP66.

Surge protection device. 275Vac. Maximum discharge current 10KA (8/20us). Maximum operating current 5A. Suitable for series connection. IP66.

F990E00A000

116,00 €

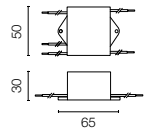

Belvedere

Designed by Antonio Citterio assistant Toan Nguyen





Belvedere Clove

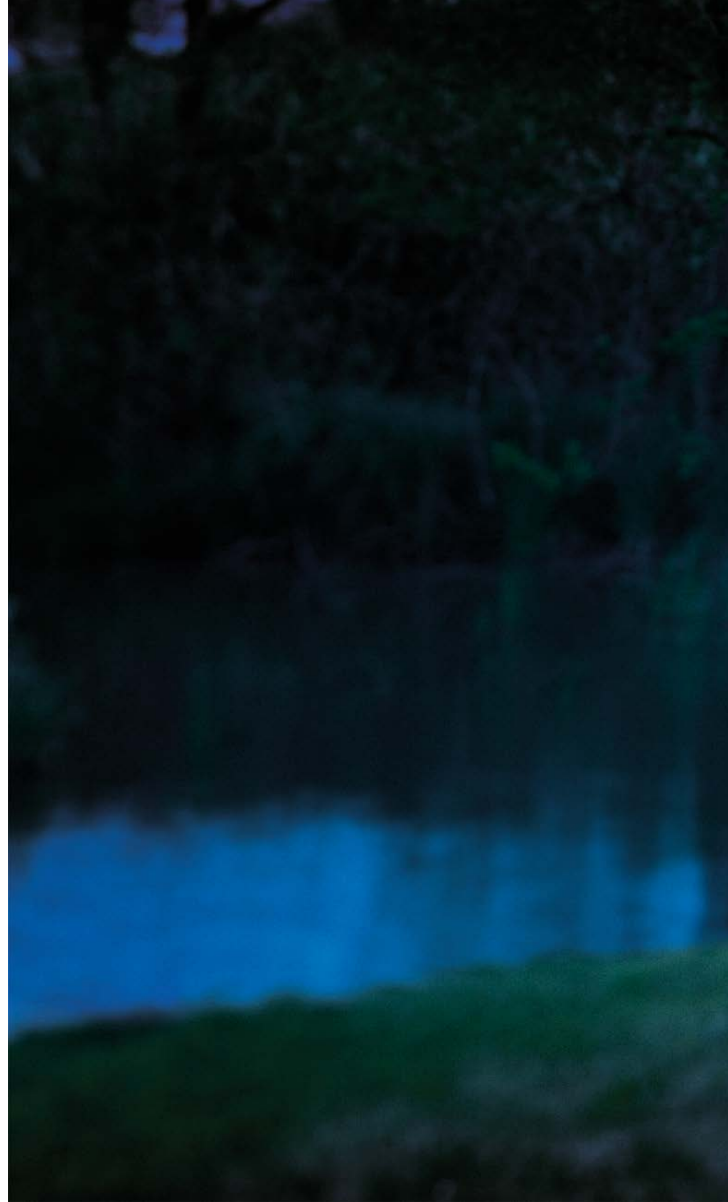

Belvedere Spot



Famille / Family

Belvedere Clove



Power Led

8,4W

631 lm - 2700K/CRI 80

657 lm - 3000K/CRI 80

703 lm - 4000K/CRI 80

2200K available on request.

Belvedere Spot



Power Led

6W

425 lm - 2700K/CRI 80

440 lm - 3000K/CRI 80

473 lm - 4000K/CRI 80

Floor 1

2200K available on request.

Belvedere Spot Wall



Power Led

6W

425 lm - 2700K/CRI 80

440 lm - 3000K/CRI 80

473 lm - 4000K/CRI 80

Finitions / Colours



01 White

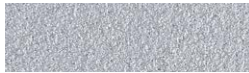

06 Grey



12 Forest Green



18 Deep Brown



30 Black



33 Anthracite

Belvedere Spot

Famille de luminaires d'extérieur à LED orientables (double rotation, axe vertical et horizontal) pour installation au sol (sol dur ou sol meuble) avec boîtier d'alimentation intégré.

Belvedere Spot Wall

Luminaires d'extérieur composé d'un projecteur orientable à $350^{\circ}\pm 5^{\circ}$ sur l'axe horizontal pour installation au mur, avec boîtier d'alimentation intégré.

Belvedere Clove

Famille de luminaires d'extérieur avec mât en deux hauteurs différentes pour installation au sol (sol dur ou sol meuble) avec boîtier d'alimentation intégré.

Il est recommandé d'utiliser un système de connexion présentant un degré de protection supérieur ou égal au degré de protection de l'appareil.

Belvedere Spot

Family of adjustable outdoor LED lighting luminaires (double rotation, vertical and horizontal axle) suitable for floor installations (ground or buried) and with integrated power supply box.

Belvedere Spot Wall

Outdoor luminaire consisting of an adjustable projector for up to $350^{\circ}\pm 5^{\circ}$ on the horizontal axle suitable for wall installations and with integrated power supply box.

Belvedere Clove

Family of outdoor products consisting of luminaires with a pole of two different heights and suitable for floor installations (ground or buried) and with integrated power supply box.

We recommend using a connection system with a degree of protection greater than or equal to the degree of protection of the luminaire.

Belvedere Clove 1

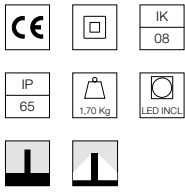
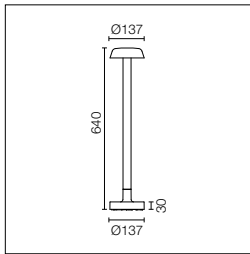

Alimentation 220-240V comprise. Pour installation sur base rigide. Boîtier pour installation dans le sol à commander séparément. Includ un système de jonction IP68 H2O Stop anti-condensation à 2 voies 4 pôles. Version 110V sur demande.

220-240V power supply included. Ready for installation on solid surface. Box for ground installation to be ordered separately. Included 2 way terminal block 4 poles IP68 H2O Stop. Version 110V upon request.

2200K disponible sur demande.

2200K available on request.

Power Led: 8,4W - 783 lm ≠ FIXT 631 lm - 2700K/CRI 80 - 220-240V / 8,4W - 816 lm ≠ FIXT 657 lm - 3000K/CRI 80 - 220-240V / 8,4W - 873 lm ≠ FIXT 703 lm - 4000K/CRI 80 - 220-240V

2700K

Non Dimmable

○ F001A21A001	541,00 €
● F001A21A006	541,00 €
● F001A21A012	541,00 €
● F001A21A018	541,00 €
● F001A21A030	541,00 €
● F001A21A033	541,00 €

1-10V

○ F001A21B001	602,00 €
● F001A21B006	602,00 €
● F001A21B012	602,00 €
● F001A21B018	602,00 €
● F001A21B030	602,00 €
● F001A21B033	602,00 €

Dali

○ F001A21D001	652,00 €
● F001A21D006	652,00 €
● F001A21D012	652,00 €
● F001A21D018	652,00 €
● F001A21D030	652,00 €
● F001A21D033	652,00 €

3000K

Non Dimmable

○ F001A31A001	541,00 €
● F001A31A006	541,00 €
● F001A31A012	541,00 €
● F001A31A018	541,00 €
● F001A31A030	541,00 €
● F001A31A033	541,00 €

1-10V

○ F001A31B001	602,00 €
● F001A31B006	602,00 €
● F001A31B012	602,00 €
● F001A31B018	602,00 €
● F001A31B030	602,00 €
● F001A31B033	602,00 €

Dali

○ F001A31D001	652,00 €
● F001A31D006	652,00 €
● F001A31D012	652,00 €
● F001A31D018	652,00 €
● F001A31D030	652,00 €
● F001A31D033	652,00 €

4000K

Non Dimmable

○ F001A41A001	541,00 €
● F001A41A006	541,00 €
● F001A41A012	541,00 €
● F001A41A018	541,00 €
● F001A41A030	541,00 €
● F001A41A033	541,00 €

1-10V

○ F001A41B001	602,00 €
● F001A41B006	602,00 €
● F001A41B012	602,00 €
● F001A41B018	602,00 €
● F001A41B030	602,00 €
● F001A41B033	602,00 €

Dali

○ F001A41D001	652,00 €
● F001A41D006	652,00 €
● F001A41D012	652,00 €
● F001A41D018	652,00 €
● F001A41D030	652,00 €
● F001A41D033	652,00 €

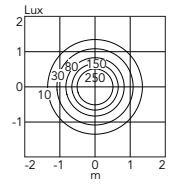
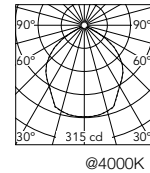

Belvedere Clove 2

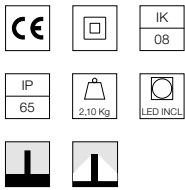
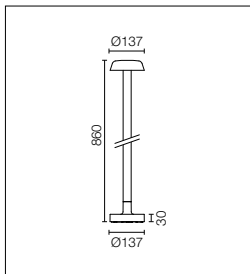

Alimentation 220-240V comprise. Pour installation sur base rigide. Boîtier pour installation dans le sol à commander séparément. Includ un système de jonction IP68 H2O Stop anti-condensation à 2 voies 4 pôles. Version 110V sur demande.

220-240V power supply included. Ready for installation on solid surface. Box for ground installation to be ordered separately. Included 2 way terminal block 4 poles IP68 H2O Stop. Version 110V upon request.

2200K disponible sur demande.

2200K available on request.

Power Led: 8,4W - 783 lm ≠ FIXT 631 lm - 2700K/CRI 80 - 220-240V / 8,4W - 816 lm ≠ FIXT 657 lm - 3000K/CRI 80 - 220-240V / 8,4W - 873 lm ≠ FIXT 703 lm - 4000K/CRI 80 - 220-240V

2700K

Non Dimmable

○ F001B21A001	565,00 €
● F001B21A006	565,00 €
● F001B21A012	565,00 €
● F001B21A018	565,00 €
● F001B21A030	565,00 €
● F001B21A033	565,00 €

1-10V

○ F001B21B001	628,00 €
● F001B21B006	628,00 €
● F001B21B012	628,00 €
● F001B21B018	628,00 €
● F001B21B030	628,00 €
● F001B21B033	628,00 €

Dali

○ F001B21D001	676,00 €
● F001B21D006	676,00 €
● F001B21D012	676,00 €
● F001B21D018	676,00 €
● F001B21D030	676,00 €
● F001B21D033	676,00 €

3000K

Non Dimmable

○ F001B31A001	565,00 €
● F001B31A006	565,00 €
● F001B31A012	565,00 €
● F001B31A018	565,00 €
● F001B31A030	565,00 €
● F001B31A033	565,00 €

1-10V

○ F001B31B001	628,00 €
● F001B31B006	628,00 €
● F001B31B012	628,00 €
● F001B31B018	628,00 €
● F001B31B030	628,00 €
● F001B31B033	628,00 €

Dali

○ F001B31D001	676,00 €
● F001B31D006	676,00 €
● F001B31D012	676,00 €
● F001B31D018	676,00 €
● F001B31D030	676,00 €
● F001B31D033	676,00 €

4000K

Non Dimmable

○ F001B41A001	565,00 €
● F001B41A006	565,00 €
● F001B41A012	565,00 €
● F001B41A018	565,00 €
● F001B41A030	565,00 €
● F001B41A033	565,00 €

1-10V

○ F001B41B001	628,00 €
● F001B41B006	628,00 €
● F001B41B012	628,00 €
● F001B41B018	628,00 €
● F001B41B030	628,00 €
● F001B41B033	628,00 €

Dali

○ F001B41D001	676,00 €
● F001B41D006	676,00 €
● F001B41D012	676,00 €
● F001B41D018	676,00 €
● F001B41D030	676,00 €
● F001B41D033	676,00 €

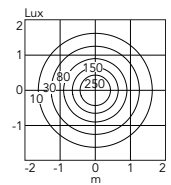
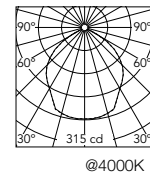

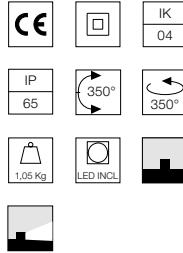
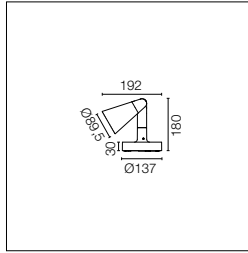

Alimentation 220-240V comprise. Version dimmable sur demande. Pour installation sur base rigide. Boitier pour installation dans le sol à commander séparément. Inclut un système de jonction IP68 H2O Stop anti-condensation à 2 voies 4 pôles. Version dimmable 24V disponible sur demande.

220-240V power supply included. Ready for installation on solid surface. Box for ground installation to be ordered separately. Included 2 way terminal block 4 poles IP68 H2O Stop. 24V Dimmable version available on request.

2200K disponible sur demande.

2200K available on request.

Power Led: 6W - 513 lm ≠ *FIXT 425 lm - 2700K/CRI 80 - 220-240V / 6W - 530 lm ≠ *FIXT 440 lm - 3000K/CRI 80 - 220-240V / 6W - 570 lm ≠ *FIXT 473 lm - 4000K/CRI 80 - 220-240V
 *FIXT lm = Spot Optic

2700K

- Non Dimmable
- F001C21A001.A 528,00 €
 - F001C21A006.A 528,00 €
 - F001C21A012.A 528,00 €
 - F001C21A018.A 528,00 €
 - F001C21A030.A 528,00 €
 - F001C21A033.A 528,00 €

2700K

- Non Dimmable
- F001C22A001.A 528,00 €
 - F001C22A006.A 528,00 €
 - F001C22A012.A 528,00 €
 - F001C22A018.A 528,00 €
 - F001C22A030.A 528,00 €
 - F001C22A033.A 528,00 €

2700K

- Non Dimmable
- F001C23A001.A 528,00 €
 - F001C23A006.A 528,00 €
 - F001C23A012.A 528,00 €
 - F001C23A018.A 528,00 €
 - F001C23A030.A 528,00 €
 - F001C23A033.A 528,00 €

3000K

- Non Dimmable
- F001C31A001.A 528,00 €
 - F001C31A006.A 528,00 €
 - F001C31A012.A 528,00 €
 - F001C31A018.A 528,00 €
 - F001C31A030.A 528,00 €
 - F001C31A033.A 528,00 €

3000K

- Non Dimmable
- F001C32A001.A 528,00 €
 - F001C32A006.A 528,00 €
 - F001C32A012.A 528,00 €
 - F001C32A018.A 528,00 €
 - F001C32A030.A 528,00 €
 - F001C32A033.A 528,00 €

3000K

- Non Dimmable
- F001C33A001.A 528,00 €
 - F001C33A006.A 528,00 €
 - F001C33A012.A 528,00 €
 - F001C33A018.A 528,00 €
 - F001C33A030.A 528,00 €
 - F001C33A033.A 528,00 €

4000K

- Non Dimmable
- F001C41A001 528,00 €
 - F001C41A006 528,00 €
 - F001C41A012 528,00 €
 - F001C41A018 528,00 €
 - F001C41A030 528,00 €
 - F001C41A033 528,00 €

4000K

- Non Dimmable
- F001C42A001 528,00 €
 - F001C42A006 528,00 €
 - F001C42A012 528,00 €
 - F001C42A018 528,00 €
 - F001C42A030 528,00 €
 - F001C42A033 528,00 €

4000K

- Non Dimmable
- F001C43A001 528,00 €
 - F001C43A006 528,00 €
 - F001C43A012 528,00 €
 - F001C43A018 528,00 €
 - F001C43A030 528,00 €
 - F001C43A033 528,00 €

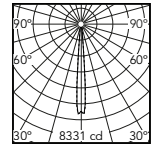

Beam Angle: 9°

h(m)	Ef(x)	D(m)
1	8330	0.16
2	2083	0.32
3	926	0.48
4	521	0.64
5	333	0.80

@4000K

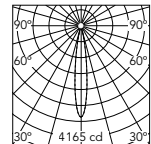

Beam Angle: 15°

h(m)	Ef(x)	D(m)
1	4165	0.26
2	1041	0.52
3	463	0.79
4	260	1.05
5	167	1.31

@4000K

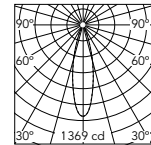

Beam Angle: 26°

h(m)	Ef(x)	D(m)
1	1369	0.46
2	342	0.93
3	152	1.39
4	86	1.85
5	55	2.31

@4000K

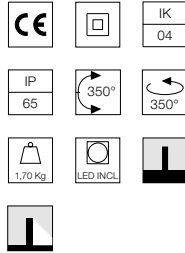
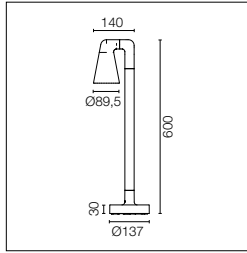

Alimentation 220-240V comprise. Pour installation sur base rigide. Boîtier pour installation dans le sol à commander séparément. Inclut un système de jonction IP68 H2O Stop anti-condensation à 2 voies 4 pôles. Version 110V sur demande.

220-240V power supply included. Ready for installation on solid surface. Box for ground installation to be ordered separately. Included 2 way terminal block 4 poles IP68 H2O Stop. Version 110V upon request.

Power Led: 6W - 513 lm ≠ *FIXT 425 lm - 2700K/CRI 80 - 220-240V / 6W - 530 lm ≠ *FIXT 440 lm - 3000K/CRI 80 - 220-240V / 6W - 570 lm ≠ *FIXT 473 lm - 4000K/CRI 80 - 220-240V / *FIXT lm = Spot Optic

2700K

- Non Dimmable
- F001D21A001.A 589,00 €
 - F001D21A006.A 589,00 €
 - F001D21A012.A 589,00 €
 - F001D21A018.A 589,00 €
 - F001D21A030.A 589,00 €
 - F001D21A033.A 589,00 €
- 1-10V
- F001D21B001.A 652,00 €
 - F001D21B006.A 652,00 €
 - F001D21B012.A 652,00 €
 - F001D21B018.A 652,00 €
 - F001D21B030.A 652,00 €
 - F001D21B033.A 652,00 €

3000K

- Non Dimmable
- F001D31A001.A 589,00 €
 - F001D31A006.A 589,00 €
 - F001D31A012.A 589,00 €
 - F001D31A018.A 589,00 €
 - F001D31A030.A 589,00 €
 - F001D31A033.A 589,00 €
- 1-10V
- F001D31B001.A 652,00 €
 - F001D31B006.A 652,00 €
 - F001D31B012.A 652,00 €
 - F001D31B018.A 652,00 €
 - F001D31B030.A 652,00 €
 - F001D31B033.A 652,00 €

4000K

- Non Dimmable
- F001D41A001 589,00 €
 - F001D41A006 589,00 €
 - F001D41A012 589,00 €
 - F001D41A018 589,00 €
 - F001D41A030 589,00 €
 - F001D41A033 589,00 €
- 1-10V
- F001D41B001 652,00 €
 - F001D41B006 652,00 €
 - F001D41B012 652,00 €
 - F001D41B018 652,00 €
 - F001D41B030 652,00 €
 - F001D41B033 652,00 €

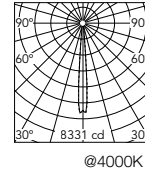

Beam Angle: 9°

h(m)	E(lx)	D(m)
1	8330	0.16
2	2083	0.32
3	926	0.48
4	521	0.64
5	333	0.80

2700K

- Non Dimmable
- F001D22A001.A 589,00 €
 - F001D22A006.A 589,00 €
 - F001D22A012.A 589,00 €
 - F001D22A018.A 589,00 €
 - F001D22A030.A 589,00 €
 - F001D22A033.A 589,00 €
- 1-10V
- F001D22B001.A 652,00 €
 - F001D22B006.A 652,00 €
 - F001D22B033.A 652,00 €
 - F001D22B030.A 652,00 €
 - F001D22B018.A 652,00 €
 - F001D22B012.A 652,00 €

3000K

- Non Dimmable
- F001D32A001.A 589,00 €
 - F001D32A006.A 589,00 €
 - F001D32A012.A 589,00 €
 - F001D32A018.A 589,00 €
 - F001D32A030.A 589,00 €
 - F001D32A033.A 589,00 €
- 1-10V
- F001D32B001.A 652,00 €
 - F001D32B006.A 652,00 €
 - F001D32B012.A 652,00 €
 - F001D32B018.A 652,00 €
 - F001D32B030.A 652,00 €
 - F001D32B033.A 652,00 €

4000K

- Non Dimmable
- F001D42A001 589,00 €
 - F001D42A006 589,00 €
 - F001D42A012 589,00 €
 - F001D42A018 589,00 €
 - F001D42A030 589,00 €
 - F001D42A033 589,00 €
- 1-10V
- F001D42B001 652,00 €
 - F001D42B006 652,00 €
 - F001D42B012 652,00 €
 - F001D42B018 652,00 €
 - F001D42B030 652,00 €
 - F001D42B033 652,00 €

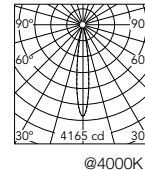

Beam Angle: 15°

h(m)	E(lx)	D(m)
1	4165	0.26
2	1041	0.52
3	463	0.79
4	260	1.05
5	167	1.31

2700K

- Non Dimmable
- F001D23A001.A 589,00 €
 - F001D23A006.A 589,00 €
 - F001D23A012.A 589,00 €
 - F001D23A018.A 589,00 €
 - F001D23A030.A 589,00 €
 - F001D23A033.A 589,00 €
- 1-10V
- F001D23B001.A 652,00 €
 - F001D23B006.A 652,00 €
 - F001D23B012.A 652,00 €
 - F001D23B018.A 652,00 €
 - F001D23B030.A 652,00 €
 - F001D23B033.A 652,00 €

3000K

- Non Dimmable
- F001D33A001.A 589,00 €
 - F001D33A006.A 589,00 €
 - F001D33A012.A 589,00 €
 - F001D33A018.A 589,00 €
 - F001D33A030.A 589,00 €
 - F001D33A033.A 589,00 €
- 1-10V
- F001D33B001.A 652,00 €
 - F001D33B006.A 652,00 €
 - F001D33B012.A 652,00 €
 - F001D33B018.A 652,00 €
 - F001D33B030.A 652,00 €
 - F001D33B033.A 652,00 €

4000K

- Non Dimmable
- F001D43A001 589,00 €
 - F001D43A006 589,00 €
 - F001D43A012 589,00 €
 - F001D43A018 589,00 €
 - F001D43A030 589,00 €
 - F001D43A033 589,00 €
- 1-10V
- F001D43B001 652,00 €
 - F001D43B006 652,00 €
 - F001D43B012 652,00 €
 - F001D43B018 652,00 €
 - F001D43B030 652,00 €
 - F001D43B033 652,00 €

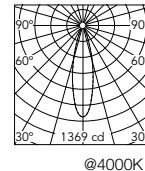

Beam Angle: 26°

h(m)	E(lx)	D(m)
1	1369	0.46
2	342	0.93
3	152	1.39
4	86	1.85
5	55	2.31

Belvedere Spot Floor 3

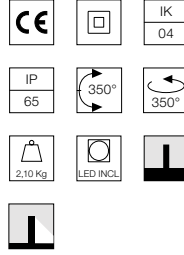
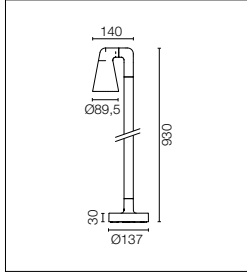

Alimentation 220-240V comprise. Pour installation sur base rigide. Boîtier pour installation dans le sol à commander séparément. Inclut un système de jonction IP68 H2O Stop anti-condensation à 2 voies 4 pôles. Version 110V sur demande.

220-240V power supply included. Ready for installation on solid surface. Box for ground installation to be ordered separately. Included 2 way terminal block 4 poles IP68 H2O Stop. Version 110V upon request.

Power Led: 6W - 513 lm ≠ *FIXT 425 lm - 2700K/CRI 80 - 220-240V / 6W - 530 lm ≠ *FIXT 440 lm - 3000K/CRI 80 - 220-240V / 6W - 570 lm ≠ *FIXT 473 lm - 4000K/CRI 80 - 220-240V / *FIXT lm = Spot Optic

2700K

Non Dimmable

○ F001E21A001.A	602,00 €
● F001E21A006.A	602,00 €
● F001E21A012.A	602,00 €
● F001E21A018.A	602,00 €
● F001E21A030.A	602,00 €
● F001E21A033.A	602,00 €
1-10V	
○ F001E21B001.A	665,00 €
● F001E21B006.A	665,00 €
● F001E21B012.A	665,00 €
● F001E21B018.A	665,00 €
● F001E21B030.A	665,00 €
● F001E21B033.A	665,00 €
Dali	
○ F001E21D001.A	715,00 €
● F001E21D006.A	715,00 €
● F001E21D012.A	715,00 €
● F001E21D018.A	715,00 €
● F001E21D030.A	715,00 €
● F001E21D033.A	715,00 €

2700K

Non Dimmable

○ F001E22A001.A	602,00 €
● F001E22A006.A	602,00 €
● F001E22A012.A	602,00 €
● F001E22A018.A	602,00 €
● F001E22A030.A	602,00 €
● F001E22A033.A	602,00 €
1-10V	
○ F001E22B001.A	665,00 €
● F001E22B006.A	665,00 €
● F001E22B012.A	665,00 €
● F001E22B018.A	665,00 €
● F001E22B030.A	665,00 €
● F001E22B033.A	665,00 €
Dali	
○ F001E22D001.A	715,00 €
● F001E22D006.A	715,00 €
● F001E22D012.A	715,00 €
● F001E22D018.A	715,00 €
● F001E22D030.A	715,00 €
● F001E22D033.A	715,00 €

2700K

Non Dimmable

○ F001E23A001.A	602,00 €
● F001E23A006.A	602,00 €
● F001E23A012.A	602,00 €
● F001E23A018.A	602,00 €
● F001E23A030.A	602,00 €
● F001E23A033.A	602,00 €
1-10V	
○ F001E23B001.A	665,00 €
● F001E23B006.A	665,00 €
● F001E23B012.A	665,00 €
● F001E23B018.A	665,00 €
● F001E23B030.A	665,00 €
● F001E23B033.A	665,00 €
Dali	
○ F001E23D001.A	715,00 €
● F001E23D006.A	715,00 €
● F001E23D012.A	715,00 €
● F001E23D018.A	715,00 €
● F001E23D030.A	715,00 €
● F001E23D033.A	715,00 €

3000K

Non Dimmable

○ F001E31A001.A	602,00 €
● F001E31A006.A	602,00 €
● F001E31A012.A	602,00 €
● F001E31A018.A	602,00 €
● F001E31A030.A	602,00 €
● F001E31A033.A	602,00 €
1-10V	
○ F001E31B001.A	665,00 €
● F001E31B006.A	665,00 €
● F001E31B012.A	665,00 €
● F001E31B018.A	665,00 €
● F001E31B030.A	665,00 €
● F001E31B033.A	665,00 €
Dali	
○ F001E31D001.A	715,00 €
● F001E31D006.A	715,00 €
● F001E31D012.A	715,00 €
● F001E31D018.A	715,00 €
● F001E31D030.A	715,00 €
● F001E31D033.A	715,00 €

3000K

Non Dimmable

○ F001E32A001.A	602,00 €
● F001E32A006.A	602,00 €
● F001E32A012.A	602,00 €
● F001E32A018.A	602,00 €
● F001E32A030.A	602,00 €
● F001E32A033.A	602,00 €
1-10V	
○ F001E32B001.A	665,00 €
● F001E32B006.A	665,00 €
● F001E32B012.A	665,00 €
● F001E32B018.A	665,00 €
● F001E32B030.A	665,00 €
● F001E32B033.A	665,00 €
Dali	
○ F001E32D001.A	715,00 €
● F001E32D006.A	715,00 €
● F001E32D012.A	715,00 €
● F001E32D018.A	715,00 €
● F001E32D030.A	715,00 €
● F001E32D033.A	715,00 €

3000K

Non Dimmable

○ F001E33A001	602,00 €
● F001E33A006	602,00 €
● F001E33A012	602,00 €
● F001E33A018	602,00 €
● F001E33A030	602,00 €
● F001E33A033	602,00 €
1-10V	
○ F001E33B001	665,00 €
● F001E33B006	665,00 €
● F001E33B012	665,00 €
● F001E33B018	665,00 €
● F001E33B030	665,00 €
● F001E33B033	665,00 €
Dali	
○ F001E33D001	715,00 €
● F001E33D006	715,00 €
● F001E33D012	715,00 €
● F001E33D018	715,00 €
● F001E33D030	715,00 €
● F001E33D033	715,00 €

4000K

Non Dimmable

○ F001E41A001	602,00 €
● F001E41A006	602,00 €
● F001E41A012	602,00 €
● F001E41A018	602,00 €
● F001E41A030	602,00 €
● F001E41A033	602,00 €
1-10V	
○ F001E41B001	665,00 €
● F001E41B006	665,00 €
● F001E41B012	665,00 €
● F001E41B018	665,00 €
● F001E41B030	665,00 €
● F001E41B033	665,00 €
Dali	
○ F001E41D001	715,00 €
● F001E41D006	715,00 €
● F001E41D012	715,00 €
● F001E41D018	715,00 €
● F001E41D030	715,00 €
● F001E41D033	715,00 €

4000K

Non Dimmable

○ F001E42A001	602,00 €
● F001E42A006	602,00 €
● F001E42A012	602,00 €
● F001E42A018	602,00 €
● F001E42A030	602,00 €
● F001E42A033	602,00 €
1-10V	
○ F001E42B001	665,00 €
● F001E42B006	665,00 €
● F001E42B012	665,00 €
● F001E42B018	665,00 €
● F001E42B030	665,00 €
● F001E42B033	665,00 €
Dali	
○ F001E42D001	715,00 €
● F001E42D006	715,00 €
● F001E42D012	715,00 €
● F001E42D018	715,00 €
● F001E42D030	715,00 €
● F001E42D033	715,00 €

4000K

Non Dimmable

○ F001E43A001	602,00 €
● F001E43A006	602,00 €
● F001E43A012	602,00 €
● F001E43A018	602,00 €
● F001E43A030	602,00 €
● F001E43A033	602,00 €
1-10V	
○ F001E43B001	665,00 €
● F001E43B006	665,00 €
● F001E43B012	665,00 €
● F001E43B018	665,00 €
● F001E43B030	665,00 €
● F001E43B033	665,00 €
Dali	
○ F001E43D001	715,00 €
● F001E43D006	715,00 €
● F001E43D012	715,00 €
● F001E43D018	715,00 €
● F001E43D030	715,00 €
● F001E43D033	715,00 €

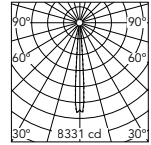

Beam Angle: 9°

h(m)	E(ft)	D(m)
1	8330	0.16
2	2083	0.32
3	926	0.48
4	521	0.64
5	333	0.80

@4000K

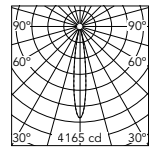

Beam Angle: 15°

h(m)	E(ft)	D(m)
1	4165	0.26
2	1041	0.52
3	463	0.79
4	260	1.05
5	167	1.31

@4000K

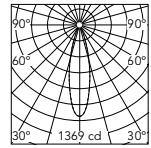

Beam Angle: 26°

h(m)	E(ft)	D(m)
1	1369	0.46
2	342	0.93
3	152	1.39
4	86	1.85
5	55	2.31

@4000K

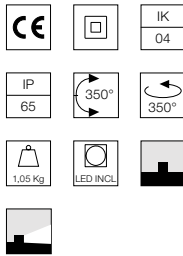
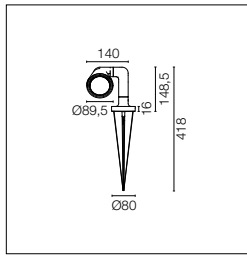

Alimentation 220-240V comprise. Inclut un système de jonction IP68 H2O Stop anti-condensation à 2 voies 4 pôles. Version dimmable 24V disponible sur demande. Version 110V sur demande.

220-240V power supply included. Included 2 way terminal block 4 poles IP68 H2O Stop. 24V Dimmable version available on request. Version 110V upon request.

Power Led: 6W - 513 lm ≠ *FIXT 425 lm - 2700K/CRI 80 - 220-240V / 6W - 530 lm ≠ *FIXT 440 lm - 3000K/CRI 80 - 220-240V / 6W - 570 lm ≠ *FIXT 473 lm - 4000K/CRI 80 - 220-240V
 *FIXT lm = Spot Optic

2700K

- Non Dimmable
- F001F21A001.A 489,00 €
 - F001F21A006.A 489,00 €
 - F001F21A012.A 489,00 €
 - F001F21A018.A 489,00 €
 - F001F21A030.A 489,00 €
 - F001F21A033.A 489,00 €

3000K

- Non Dimmable
- F001F31A001.A 489,00 €
 - F001F31A006.A 489,00 €
 - F001F31A012.A 489,00 €
 - F001F31A018.A 489,00 €
 - F001F31A030.A 489,00 €
 - F001F31A033.A 489,00 €

4000K

- Non Dimmable
- F001F41A001 489,00 €
 - F001F41A006 489,00 €
 - F001F41A012 489,00 €
 - F001F41A018 489,00 €
 - F001F41A030 489,00 €
 - F001F41A033 489,00 €

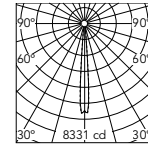

Beam Angle: 9°

h(m)	E(lx)	D(m)
1	8330	0.16
2	2083	0.32
3	926	0.48
4	521	0.64
5	333	0.80

@4000K

2700K

- Non Dimmable
- F001F22A001.A 489,00 €
 - F001F22A006.A 489,00 €
 - F001F22A012.A 489,00 €
 - F001F22A018.A 489,00 €
 - F001F22A030.A 489,00 €
 - F001F22A033.A 489,00 €

3000K

- Non Dimmable
- F001F32A001.A 489,00 €
 - F001F32A006.A 489,00 €
 - F001F32A012.A 489,00 €
 - F001F32A018.A 489,00 €
 - F001F32A030.A 489,00 €
 - F001F32A033.A 489,00 €

4000K

- Non Dimmable
- F001F42A001 489,00 €
 - F001F42A006 489,00 €
 - F001F42A012 489,00 €
 - F001F42A018 489,00 €
 - F001F42A030 489,00 €
 - F001F42A033 489,00 €

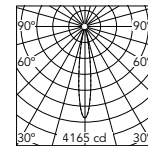

Beam Angle: 15°

h(m)	E(lx)	D(m)
1	4165	0.26
2	1041	0.52
3	463	0.79
4	260	1.05
5	167	1.31

@4000K

2700K

- Non Dimmable
- F001F23A001.A 489,00 €
 - F001F23A006.A 489,00 €
 - F001F23A012.A 489,00 €
 - F001F23A018.A 489,00 €
 - F001F23A030.A 489,00 €
 - F001F23A033.A 489,00 €

3000K

- Non Dimmable
- F001F33A001.A 489,00 €
 - F001F33A006.A 489,00 €
 - F001F33A012.A 489,00 €
 - F001F33A018.A 489,00 €
 - F001F33A030.A 489,00 €
 - F001F33A033.A 489,00 €

4000K

- Non Dimmable
- F001F43A001 489,00 €
 - F001F43A006 489,00 €
 - F001F43A012 489,00 €
 - F001F43A018 489,00 €
 - F001F43A030 489,00 €
 - F001F43A033 489,00 €

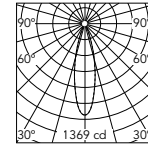

Beam Angle: 26°

h(m)	E(lx)	D(m)
1	1369	0.46
2	342	0.93
3	152	1.39
4	86	1.85
5	55	2.31

@4000K

Belvedere Spot Wall

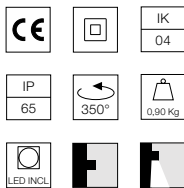
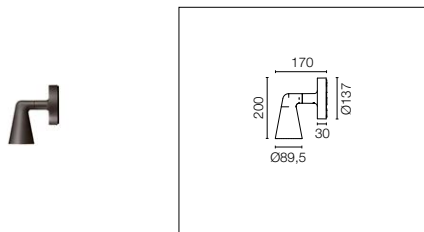

Fixation directe au mur.
Alimentation 220-240V comprise.
Inclut un système de jonction IP68 H2O Stop anti-condensation à 2 voies 4 pôles.
Version dimmable 24V disponible sur demande.

Direct wall installation. 220-240V power supply included.
Included 2 way terminal block 4 poles IP68 H2O Stop.
24V Dimmable version available on request.

Power Led: 6W - 513 lm ≠ *FIXT 425 lm - 2700K/CRI 80 - 220-240V / 6W - 530 lm ≠ *FIXT 440 lm - 3000K/CRI 80 - 220-240V / 6W - 570 lm ≠ *FIXT 473 lm - 4000K/CRI 80 - 220-240V
*FIXT lm = Spot Optic

2700K

Non Dimmable	
○ F001G21A001.A	439,00 €
● F001G21A006.A	439,00 €
● F001G21A012.A	439,00 €
● F001G21A018.A	439,00 €
● F001G21A030.A	439,00 €
● F001G21A033.A	439,00 €

3000K

Non Dimmable	
○ F001G31A001.A	439,00 €
● F001G31A006.A	439,00 €
● F001G31A012.A	439,00 €
● F001G31A018.A	439,00 €
● F001G31A030.A	439,00 €
● F001G31A033.A	439,00 €

4000K

Non Dimmable	
○ F001G41A001	439,00 €
● F001G41A006	439,00 €
● F001G41A012	439,00 €
● F001G41A018	439,00 €
● F001G41A030	439,00 €
● F001G41A033	439,00 €

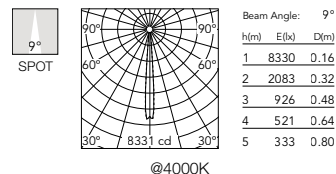

2700K

Non Dimmable	
○ F001G22A001.A	439,00 €
● F001G22A006.A	439,00 €
● F001G22A012.A	439,00 €
● F001G22A018.A	439,00 €
● F001G22A030.A	439,00 €
● F001G22A033.A	439,00 €

3000K

Non Dimmable	
○ F001G32A001.A	439,00 €
● F001G32A006.A	439,00 €
● F001G32A012.A	439,00 €
● F001G32A018.A	439,00 €
● F001G32A030.A	439,00 €
● F001G32A033.A	439,00 €

4000K

Non Dimmable	
○ F001G42A001	439,00 €
● F001G42A006	439,00 €
● F001G42A012	439,00 €
● F001G42A018	439,00 €
● F001G42A030	439,00 €
● F001G42A033	439,00 €

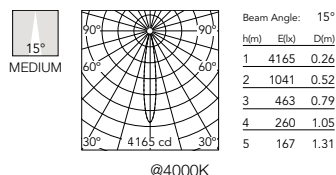

2700K

Non Dimmable	
○ F001G23A001.A	439,00 €
● F001G23A006.A	439,00 €
● F001G23A012.A	439,00 €
● F001G23A018.A	439,00 €
● F001G23A030.A	439,00 €
● F001G23A033.A	439,00 €

3000K

Non Dimmable	
○ F001G33A001.A	439,00 €
● F001G33A006.A	439,00 €
● F001G33A012.A	439,00 €
● F001G33A018.A	439,00 €
● F001G33A030.A	439,00 €
● F001G33A033.A	439,00 €

4000K

Non Dimmable	
○ F001G43A001	439,00 €
● F001G43A006	439,00 €
● F001G43A012	439,00 €
● F001G43A018	439,00 €
● F001G43A030	439,00 €
● F001G43A033	439,00 €

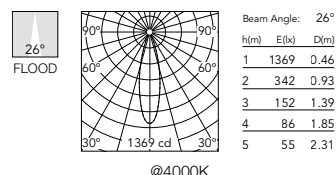

Belvedere Spot: Accessoires / Accessories

Boîtier pour installation au sol.	Box for ground installation.	Belvedere Spot / Clove	F001Z020000	61,00 €
-----------------------------------	------------------------------	------------------------	-------------	---------

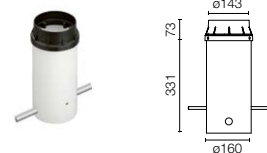

Visière spot.	Spot visor.	Belvedere Spot	F001Z010000	72,00 €
---------------	-------------	----------------	-------------	---------



Visière spot avec "honeycomb".	Spot visor with honeycomb.	Belvedere Spot	F001Z030000	86,00 €
--------------------------------	----------------------------	----------------	-------------	---------



Visière spot avec lentille "flood".	Spot visor with flood lens.	Belvedere Spot	F001Z040000	92,00 €
-------------------------------------	-----------------------------	----------------	-------------	---------



Dispositif de protection contre les surtensions. 275Vac. Courant de décharge maximal 10KA (8/20us). Adapté pour les connexions en séries. IP66.	Surge protection device. 275Vac. Maximum discharge current 10KA (8/20us). Maximum operating current 5A. Suitable for series connection. IP66.	Belvedere Spot / Clove / Wall	F990E00A000	116,00 €
---	---	-------------------------------	-------------	----------

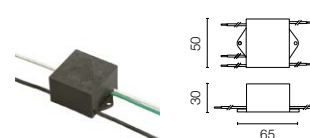

Klein Pro

Designed by Flos Outdoor







Klein Pro

Famille / Family

Klein Pro



Power Led

11W

294 lm - 2700K/CRI 80

304 lm - 3000K/CRI 80

325 lm - 4000K/CRI 80

Finitions / Colours



01 White

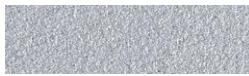

06 Grey



12 Forest Green



18 Deep Brown



30 Black



33 Anthracite



70 Anodized Natural



71 Anodized Black



73 Anodized Gold*

* Seulement pour mât écran. / Only for pole screen.

Description / Description

Le corps de la borne Klein Pro est en aluminium extrudé, la base et le diffuseur

sont en aluminium moulé sous pression EN AB-47100 à faible teneur en cuivre.

Revêtement haute résistance : le revêtement externe est appliqué en double couche de poudres epoxy selon la norme QUALICOAT. La première couche de poudres epoxy fournit une résistance chimique et mécanique, la deuxième couche de finition de poudre polyester garantit la résistance.

Egalement disponible en finition anodisée.

Klein Pro est compatible avec la plaque de fixation "Klein" existante.

The body of Klein Pro bollard is made of extruded aluminium, base and diffuser in die-cast aluminium EN AB-47100 with a low copper content.

High-resistance coating: the external coating is applied with a double layer with epoxy powders according to the QUALICOAT standard. The first layer of epoxy powder gives chemical and mechanical resistance, the second finishing layer of polyester powder ensures resistance.

Also available in anodized finishes.

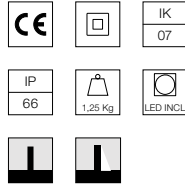
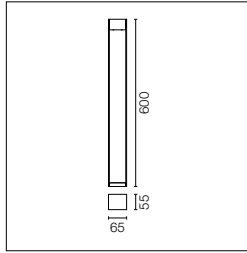

Alimentation électrique 220-240V intégrée. Accessoires pour surface dure ou sol meuble à commander séparément. Chaque luminaire est équipé d'un segment de 1000 mm de câble sortant et d'un kit de câblage.

220-240V power supply integrated. Solid surface or ground installation accessories to be ordered separately. Each luminaire is equipped with 1000 mm length outgoing cable and a wiring kit.

Power Led: 11W - 1089 lm ≠ FIXT 294 lm - 2700K/CRI 80 - 220-240V / 11W - 1126 lm ≠ FIXT 304 lm - 3000K/CRI 80 - 220-240V / 11W - 1211 lm ≠ FIXT 325 lm - 4000K/CRI 80 - 220-240V

2700K

Non Dimmable

- F002A20A001.B 292,00 €
- F002A20A006.B 292,00 €
- F002A20A012.B 292,00 €
- F002A20A018.B 292,00 €
- F002A20A030.B 292,00 €
- F002A20A033.B 292,00 €
- F002A21A070.B 350,00 €
- F002A21A071.B 365,00 €

1-10V

- F002A20B001.B 352,00 €
- F002A20B006.B 352,00 €
- F002A20B012.B 352,00 €
- F002A20B018.B 352,00 €
- F002A20B030.B 352,00 €
- F002A20B033.B 352,00 €
- F002A21B070.B 409,00 €
- F002A21B071.B 424,00 €

Dali

- F002A20D001.B 403,00 €
- F002A20D006.B 403,00 €
- F002A20D012.B 403,00 €
- F002A20D018.B 403,00 €
- F002A20D030.B 403,00 €
- F002A20D033.B 403,00 €
- F002A21D070.B 461,00 €
- F002A21D071.B 475,00 €

3000K

Non Dimmable

- F002A30A001.B 292,00 €
- F002A30A006.B 292,00 €
- F002A30A012.B 292,00 €
- F002A30A018.B 292,00 €
- F002A30A030.B 292,00 €
- F002A30A033.B 292,00 €
- F002A31A070.B 350,00 €
- F002A31A071.B 365,00 €

1-10V

- F002A30B001.B 352,00 €
- F002A30B006.B 352,00 €
- F002A30B012.B 352,00 €
- F002A30B018.B 352,00 €
- F002A30B030.B 352,00 €
- F002A30B033.B 352,00 €
- F002A31B070.B 409,00 €
- F002A31B071.B 424,00 €

Dali

- F002A30D001.B 403,00 €
- F002A30D006.B 403,00 €
- F002A30D012.B 403,00 €
- F002A30D018.B 403,00 €
- F002A30D030.B 403,00 €
- F002A30D033.B 403,00 €
- F002A31D070.B 461,00 €
- F002A31D071.B 475,00 €

4000K

Non Dimmable

- F002A40A001.B 292,00 €
- F002A40A006.B 292,00 €
- F002A40A012.B 292,00 €
- F002A40A018.B 292,00 €
- F002A40A030.B 292,00 €
- F002A40A033.B 292,00 €
- F002A41A070.B 350,00 €
- F002A41A071.B 365,00 €

1-10V

- F002A40B001.B 352,00 €
- F002A40B006.B 352,00 €
- F002A40B012.B 352,00 €
- F002A40B018.B 352,00 €
- F002A40B030.B 352,00 €
- F002A40B033.B 352,00 €
- F002A41B070.B 409,00 €
- F002A41B071.B 424,00 €

Dali

- F002A40D001.B 403,00 €
- F002A40D006.B 403,00 €
- F002A40D012.B 403,00 €
- F002A40D018.B 403,00 €
- F002A40D030.B 403,00 €
- F002A40D033.B 403,00 €
- F002A41D070.B 461,00 €
- F002A41D071.B 475,00 €

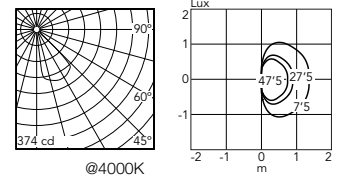

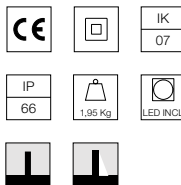
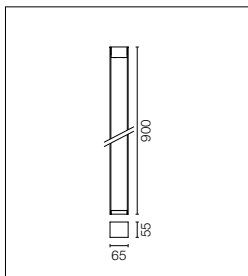

Alimentation électrique 220-240V intégrée. Accessoires pour surface dure ou sol meuble à commander séparément. Chaque luminaire est équipé d'un segment de 1000 mm de câble sortant et d'un kit de câblage.

220-240V power supply integrated. Solid surface or ground installation accessories to be ordered separately. Each luminaire is equipped with 1000 mm length outgoing cable and a wiring kit.

Power Led: 11W - 1089 lm ≠ FIXT 294 lm - 2700K/CRI 80 - 220-240V / 11W - 1126 lm ≠ FIXT 304 lm - 3000K/CRI 80 - 220-240V / 11W - 1211 lm ≠ FIXT 325 lm - 4000K/CRI 80 - 220-240V

2700K

Non Dimmable

- F002B20A001.B 323,00 €
- F002B20A006.B 323,00 €
- F002B20A012.B 323,00 €
- F002B20A018.B 323,00 €
- F002B20A030.B 323,00 €
- F002B20A033.B 323,00 €
- F002B21A070.B 386,00 €
- F002B21A071.B 403,00 €
- 1-10V
- F002B20B001.B 381,00 €
- F002B20B006.B 381,00 €
- F002B20B012.B 381,00 €
- F002B20B018.B 381,00 €
- F002B20B030.B 381,00 €
- F002B20B033.B 381,00 €
- F002B21B070.B 445,00 €
- F002B21B071.B 462,00 €

Dali

- F002B20D001.B 433,00 €
- F002B20D006.B 433,00 €
- F002B20D012.B 433,00 €
- F002B20D018.B 433,00 €
- F002B20D030.B 433,00 €
- F002B20D033.B 433,00 €
- F002B21D070.B 498,00 €
- F002B21D071.B 515,00 €

3000K

Non Dimmable

- F002B30A001.B 323,00 €
- F002B30A006.B 323,00 €
- F002B30A012.B 323,00 €
- F002B30A018.B 323,00 €
- F002B30A030.B 323,00 €
- F002B30A033.B 323,00 €
- F002B31A070.B 386,00 €
- F002B31A071.B 403,00 €
- 1-10V
- F002B30B001.B 381,00 €
- F002B30B006.B 381,00 €
- F002B30B012.B 381,00 €
- F002B30B018.B 381,00 €
- F002B30B030.B 381,00 €
- F002B30B033.B 381,00 €
- F002B31B070.B 445,00 €
- F002B31B071.B 462,00 €

Dali

- F002B30D001.B 433,00 €
- F002B30D006.B 433,00 €
- F002B30D012.B 433,00 €
- F002B30D018.B 433,00 €
- F002B30D030.B 433,00 €
- F002B30D033.B 433,00 €
- F002B31D070.B 498,00 €
- F002B31D071.B 515,00 €

4000K

Non Dimmable



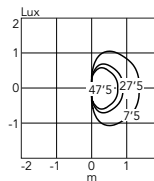
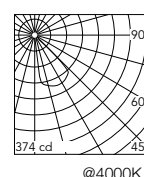

- F002B40A001.B 323,00 €
- F002B40A006.B 323,00 €
- F002B40A012.B 323,00 €
- F002B40A018.B 323,00 €
- F002B40A030.B 323,00 €
- F002B40A033.B 323,00 €
- F002B41A070.B 386,00 €
- F002B41A071.B 403,00 €
- 1-10V
- F002B40B001.B 381,00 €
- F002B40B006.B 381,00 €
- F002B40B012.B 381,00 €
- F002B40B018.B 381,00 €
- F002B40B030.B 381,00 €
- F002B40B033.B 381,00 €
- F002B41B070.B 445,00 €
- F002B41B071.B 462,00 €

Dali

- F002B40D001.B 433,00 €
- F002B40D006.B 433,00 €
- F002B40D012.B 433,00 €
- F002B40D018.B 433,00 €
- F002B40D030.B 433,00 €
- F002B40D033.B 433,00 €
- F002B41D070.B 498,00 €
- F002B41D071.B 515,00 €

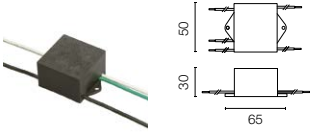

Klein Pro: Accessoires / Accessories

Base de fixation pour surfaces dures.	Fixing base for solid surfaces.	<ul style="list-style-type: none"> ○ F002Z010001.A 36,00 € ● F002Z010006.A 36,00 € ● F002Z010012.A 36,00 € ● F002Z010018.A 36,00 € ● F002Z010030.A 36,00 € ● F002Z010033.A 36,00 € 	
Plaque de fixation au sol pour Klein Pro, 47x57xH160 mm.	Minimal Klein Pro ground fixation plate, 47x57xH160 mm.	F002Z030000.A 47,00 €	
Platine de fixation au sol avec boulons Klein Pro 85x85xH160mm.	Klein Pro base plate and fixing bolts 85x85xH160 mm.	F002Z020000 24,00 €	
Ecran esthétique anodisé.	Anodized aestetical pole screen.	<ul style="list-style-type: none"> H 600 mm ● F002Z040070 48,00 € ● F002Z040071 48,00 € ● F002Z040073 48,00 € H 900 mm ● F002Z050070 53,00 € ● F002Z050071 53,00 € ● F002Z050073 53,00 € 	
Dispositif de protection contre les surtensions. 275Vac. Courant de décharge maximal 10KA (8/20us). Courant de fonctionnement maximal 5A. Adapté pour les connexions en séries. IP66.	Surge protection device. 275Vac. Maximum discharge current 10KA (8/20us). Maximum operating current 5A. Suitable for series connection. IP66.	F990E00A000 116,00 €	

Options de Montage / Installation Options

Option 1
Avec boulons d'ancrage /
Fixing anchor bolts

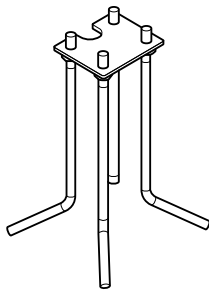
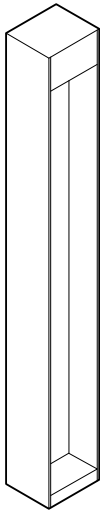

cod. F002Z030000.A

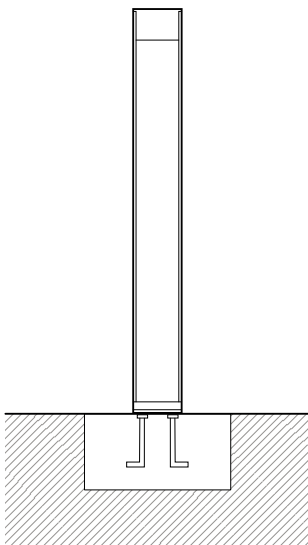

Option 2
Avec base et boulons d'ancrage /
With base and fixing anchor bolts

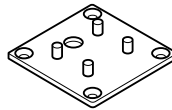

cod. F002Z0100.A

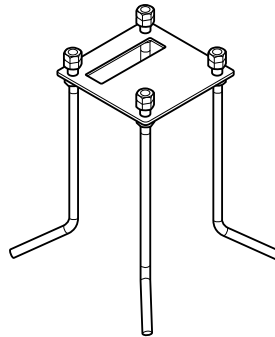

cod. F002Z020000

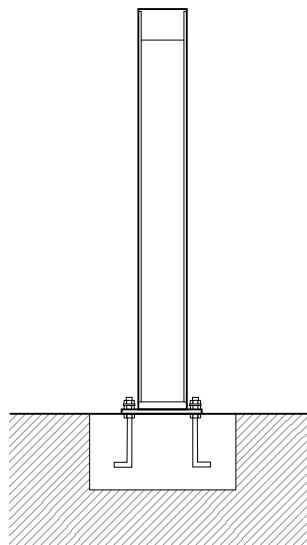

Option 3
Avec base pour boulons d'ancrage (non fournis) /
With base for bolts (not included)

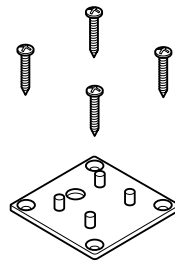

cod. F002Z0100.A

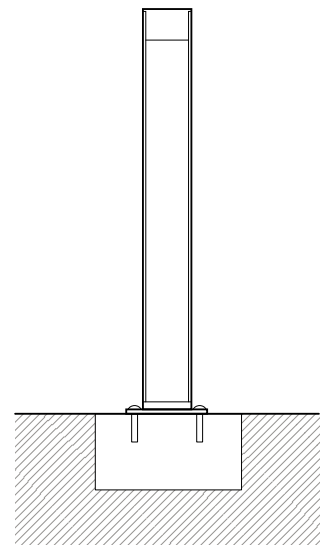

Zefiro







Famille / Family

Zefiro

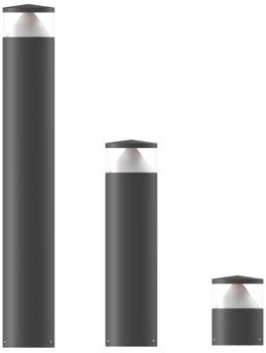

Mid - Power Led

up to 14,5W

up to 1357 lm - 2700K/CRI 80

up to 1423 lm - 3000K/CRI 80

up to 1494 lm - 4000K/CRI 80

* Net lumen output

Finitions / Colours



01 White



06 Grey



12 Forest Green



18 Deep Brown



30 Black



33 Anthracite

Description / Description

Borne d'extérieur avec source LED, disponible en trois hauteurs. Structure cylindrique en aluminium extrudé, tête en aluminium moulé, diffuseur en polycarbonate transparent résistant aux rayons UV. La source de lumière intégrée dans la tête permet une émission lumineuse asymétrique radiale, orientée vers la base, combinée avec le réflecteur conique en aluminium peint pour contenir la réflexion directe vers le haut. Disponible en différentes finitions avec un revêtement à poudre double couche et une surface traitée par procédé de conversion chimique pour garantir une haute résistance à la corrosion. La borne peut être installée facilement au sol sur tout type de revêtement, à l'aide de chevilles ou en utilisant la plaque d'ancrage dédiée et les tire-fonds qui fixent solidement le luminaire au sol. Les vis de fixation sont en acier inoxydable AISI 316L.

Outdoor bollard with LED light source. Available in three heights. Cylindrical, extruded aluminium body, die-cast aluminium cap, polycarbonate, transparent and UV-stabilized diffuser. The light source integrated in the cap allows a radial and asymmetrical light emission oriented towards the base, which can be combined to the painted aluminium, conical reflector to contain the direct reflection upwards. Available in different finishes with a double layer coating and a chemical conversion surface treatment to guarantee high resistance to corrosion. The bollard can be easily installed on any kind of ground surface, directly with studs or through the dedicated fixing plate and bolts which solidly attach the luminaire to the ground. The fixing screws are made of AISI 316L stainless steel.

Zefiro 200

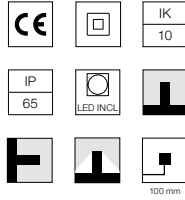
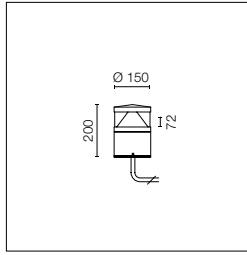

Source LED incluse. Source d'alimentation électrique intégrée 220-240V ON/OFF et intensité réglable entre 1 y 10V ou DALI. Équipée d'un câble sortant de 1 m en néoprène ainsi que d'un système d'union IP68 H2O Stop à 2 voies. Peut être installée à l'aide de chevilles sur tout type de revêtement ou avec une plaque d'ancrage encastrable avec mortier, à commander séparément.

LED source included. Integrated electric power supply 220-240V ON/OFF and adjustable light intensity from 1 to 10V or DALI. Equipped with a protruding, neoprene, one meter cable and a 2-way IP68 H2O connection system. It can be installed on any ground using studs or a recessed fixing plate with mortar, to be ordered separately.

Mid - Power Led: 14,5W - 1716 lm ≠ OUTPUT 1357 lm - 2700K/CRI 80 - 220±240V / 14,5W - 1845 lm ≠ OUTPUT 1423 lm - 3000K/CRI 80 - 220±240V / 14,5W - 1937 lm ≠ OUTPUT 1494 lm - 4000K/CRI 80 - 220±240V

2700K

Non Dimmable

○ FA53201401.A	432,00 €
● FA53201406.A	432,00 €
● FA53201412.A	432,00 €
● FA53201418.A	432,00 €
● FA53201430.A	432,00 €
● FA53201433.A	432,00 €

1-10V

○ FA53201401-310.A	601,00 €
● FA53201406-310.A	601,00 €
● FA53201412-310.A	601,00 €
● FA53201418-310.A	601,00 €
● FA53201430-310.A	601,00 €
● FA53201433-310.A	601,00 €

Dali

○ FA53201401-300.B	624,00 €
● FA53201406-300.B	624,00 €
● FA53201412-300.B	624,00 €
● FA53201418-300.B	624,00 €
● FA53201430-300.B	624,00 €
● FA53201433-300.B	624,00 €

3000K

Non Dimmable

○ FA53200301.A	432,00 €
● FA53200306.A	432,00 €
● FA53200312.A	432,00 €
● FA53200318.A	432,00 €
● FA53200330.A	432,00 €
● FA53200333.A	432,00 €

1-10V

○ FA53200301-310.A	601,00 €
● FA53200306-310.A	601,00 €
● FA53200312-310.A	601,00 €
● FA53200318-310.A	601,00 €
● FA53200330-310.A	601,00 €
● FA53200333-310.A	601,00 €

Dali

○ FA53200301-300.B	624,00 €
● FA53200306-300.B	624,00 €
● FA53200312-300.B	624,00 €
● FA53200318-300.B	624,00 €
● FA53200330-300.B	624,00 €
● FA53200333-300.B	624,00 €

4000K

Non Dimmable

○ FA53200201.A	432,00 €
● FA53200206.A	432,00 €
● FA53200212.A	432,00 €
● FA53200218.A	432,00 €
● FA53200230.A	432,00 €
● FA53200233.A	432,00 €

1-10V

○ FA53200201-310.A	601,00 €
● FA53200206-310.A	601,00 €
● FA53200212-310.A	601,00 €
● FA53200218-310.A	601,00 €
● FA53200230-310.A	601,00 €
● FA53200233-310.A	601,00 €

Dali

○ FA53200201-300.B	624,00 €
● FA53200206-300.B	624,00 €
● FA53200212-300.B	624,00 €
● FA53200218-300.B	624,00 €
● FA53200230-300.B	624,00 €
● FA53200233-300.B	624,00 €

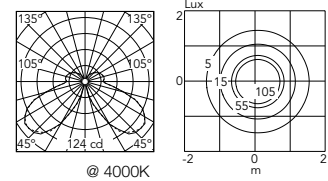

Zefiro 600

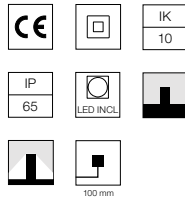
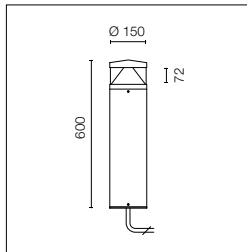

Source LED incluse. Source d'alimentation électrique intégrée 220-240V ON/OFF et intensité réglable entre 1 y 10V ou DALI. Équipée d'un câble sortant de 1 m en néoprène ainsi que d'un système d'union IP68 H2O Stop à 2 voies. Peut être installée à l'aide de chevilles sur tout type de revêtement ou avec une plaque d'ancrage encastrable avec mortier, à commander séparément. Version Mid-Night disponible sur demande.

LED source included. Integrated electric power supply 220-240V ON/OFF and adjustable light intensity from 1 to 10V or DALI. Equipped with a protruding, neoprene, one meter cable and a 2-way IP68 H2O connection system. It can be installed on any ground using studs or a recessed fixing plate with mortar, to be ordered separately. Mid-Night version available upon request.

Mid - Power Led: 14,5W - 1716 lm ≠ OUTPUT 1357 lm - 2700K/CRI 80 - 220±240V / 14,5W - 1845 lm ≠ OUTPUT 1423 lm - 2700K/CRI 80 - 220±240V / 14,5W - 1937 lm ≠ OUTPUT 1494 lm - 4000K/CRI 80 - 220±240V

2700K

Non Dimmable

○ FA53201701.A	491,00 €
● FA53201706.A	491,00 €
● FA53201712.A	491,00 €
● FA53201718.A	491,00 €
● FA53201730.A	491,00 €
● FA53201733.A	491,00 €

1-10V

○ FA53201701-310.A	664,00 €
● FA53201706-310.A	664,00 €
● FA53201712-310.A	664,00 €
● FA53201718-310.A	664,00 €
● FA53201730-310.A	664,00 €
● FA53201733-310.A	664,00 €

Dali

○ FA53201701-300.B	685,00 €
● FA53201706-300.B	685,00 €
● FA53201712-300.B	685,00 €
● FA53201718-300.B	685,00 €
● FA53201730-300.B	685,00 €
● FA53201733-300.B	685,00 €

3000K

Non Dimmable

○ FA53200601.A	491,00 €
● FA53200606.A	491,00 €
● FA53200612.A	491,00 €
● FA53200618.A	491,00 €
● FA53200630.A	491,00 €
● FA53200633.A	491,00 €

1-10V

○ FA53200601-310.A	664,00 €
● FA53200606-310.A	664,00 €
● FA53200612-310.A	664,00 €
● FA53200618-310.A	664,00 €
● FA53200630-310.A	664,00 €
● FA53200633-310.A	664,00 €

Dali

○ FA53200601-300.B	685,00 €
● FA53200606-300.B	685,00 €
● FA53200612-300.B	685,00 €
● FA53200618-300.B	685,00 €
● FA53200630-300.B	685,00 €
● FA53200633-300.B	685,00 €

4000K

Non Dimmable

○ FA53200501.A	491,00 €
● FA53200506.A	491,00 €
● FA53200512.A	491,00 €
● FA53200518.A	491,00 €
● FA53200530.A	491,00 €
● FA53200533.A	491,00 €

1-10V

○ FA53200501-310.A	664,00 €
● FA53200506-310.A	664,00 €
● FA53200512-310.A	664,00 €
● FA53200518-310.A	664,00 €
● FA53200530-310.A	664,00 €
● FA53200533-310.A	664,00 €

Dali

○ FA53200501-300.B	685,00 €
● FA53200506-300.B	685,00 €
● FA53200512-300.B	685,00 €
● FA53200518-300.B	685,00 €
● FA53200530-300.B	685,00 €
● FA53200533-300.B	685,00 €

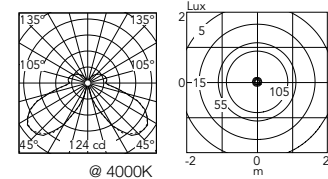

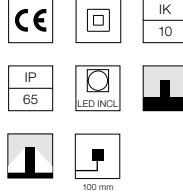
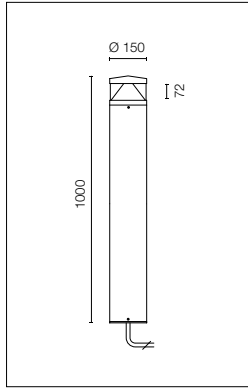

Source LED incluse. Source d'alimentation électrique intégrée 220-240V ON/OFF et intensité réglable entre 1 y 10V ou DALI. Équipée d'un câble sortant de 1 m en néoprène ainsi que d'un système d'union IP68 H2O Stop à 2 voies. Peut être installée à l'aide de chevilles sur tout type de revêtement ou avec une plaque d'ancrage encastrable avec mortier, à commander séparément. Version Mid-Night disponible sur demande.

LED source included. Integrated electric power supply 220-240V ON/OFF and adjustable light intensity from 1 to 10V or DALI. Equipped with a protruding, neoprene, one meter cable and a 2-way IP68 H2O connection system. It can be installed on any ground using studs or a recessed fixing plate with mortar, to be ordered separately. Mid-Night version available upon request.

Mid - Power Led: 14,5W - 1716 lm ≠ OUTPUT 1357 lm - 2700K/CRI 80 - 220÷240V / 14,5W - 1845 lm ≠ OUTPUT 1423 lm - 2700K/CRI 80 - 220÷240V / 14,5W - 1937 lm ≠ OUTPUT 1494 lm - 4000K/CRI 80 - 220÷240V

2700K

Non Dimmable

- FA53202001.A 539,00 €
- FA53202006.A 539,00 €
- FA53202012.A 539,00 €
- FA53202018.A 539,00 €
- FA53202030.A 539,00 €
- FA53202033.A 539,00 €

1-10V

- FA53202001-310.A 709,00 €
- FA53202006-310.A 709,00 €
- FA53202012-310.A 709,00 €
- FA53202018-310.A 709,00 €
- FA53202030-310.A 709,00 €
- FA53202033-310.A 709,00 €

Dali

- FA53202001-300.B 732,00 €
- FA53202006-300.B 732,00 €
- FA53202012-300.B 732,00 €
- FA53202018-300.B 732,00 €
- FA53202030-300.B 732,00 €
- FA53202033-300.B 732,00 €

3000K

Non Dimmable

- FA53200901.A 539,00 €
- FA53200906.A 539,00 €
- FA53200912.A 539,00 €
- FA53200918.A 539,00 €
- FA53200930.A 539,00 €
- FA53200933.A 539,00 €

1-10V

- FA53200901-310.A 709,00 €
- FA53200906-310.A 709,00 €
- FA53200912-310.A 709,00 €
- FA53200918-310.A 709,00 €
- FA53200930-310.A 709,00 €
- FA53200933-310.A 709,00 €

Dali

- FA53200901-300.B 732,00 €
- FA53200906-300.B 732,00 €
- FA53200912-300.B 732,00 €
- FA53200918-300.B 732,00 €
- FA53200930-300.B 732,00 €
- FA53200933-300.B 732,00 €

4000K

Non Dimmable

- FA53200801.A 539,00 €
- FA53200806.A 539,00 €
- FA53200812.A 539,00 €
- FA53200818.A 539,00 €
- FA53200830.A 539,00 €
- FA53200833.A 539,00 €

1-10V





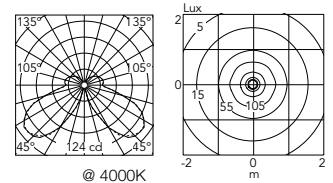

- FA53200801-310.A 709,00 €
- FA53200806-310.A 709,00 €
- FA53200812-310.A 709,00 €
- FA53200818-310.A 709,00 €
- FA53200830-310.A 709,00 €
- FA53200833-310.A 709,00 €

Dali

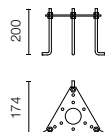
- FA53200801-300.B 732,00 €
- FA53200806-300.B 732,00 €
- FA53200812-300.B 732,00 €
- FA53200818-300.B 732,00 €
- FA53200830-300.B 732,00 €
- FA53200833-300.B 732,00 €

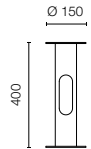

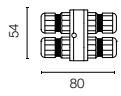
Zefiro: Accessoires / Accessories

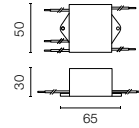
Plaque de boulons.	Base plate with bolt.	FA21	42,00 €		
Base de fixation à terre haute résistance.	High resistance in-ground box for installation	FA185.A	153,00 €		
Système de jonction IP68 H ₂ O Stop anti-condensation à 3/4 voies 4 pôles. (ø5,5÷12mm câble).	3/4 way terminal block 4 poles IP68 H ₂ O Stop. (ø5,5÷12mm cable).	F990C010000	60,00 €		
Dispositif de protection contre les surtensions. 275Vac. Courant de décharge maximal 10KA (8/20µs). Courant de fonctionnement maximal 5A. Adapté pour les connexions en séries. IP66.	Surge protection device. 275Vac. Maximum discharge current 10KA (8/20µs). Maximum operating current 5A. Suitable for series connection. IP66.	F990E00A000	116,00 €		

Méthode de fixation correcte

Borne fixée avec du ciment sur plinthe + vis de fixation adéquats

Correct Fixing Method

Bollard fixed on plinth + plug.

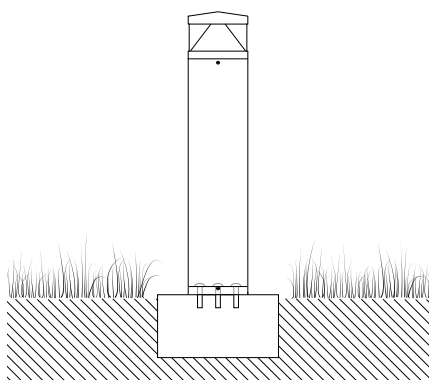

Méthode de fixation correcte

Borne fixée avec du ciment + plaque d'ancrage et tire-fonds.

Correct Fixing Method

Bollard fixed on plinth + fixing bolts.

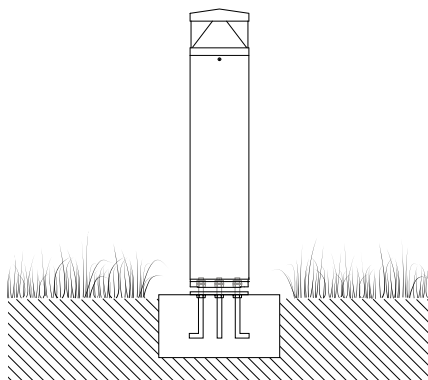

Méthode de fixation incorrecte

Ne pas fixer la borne directement au sol.

Incorrect Fixing Method

Do not fix the bollard directly on the ground.

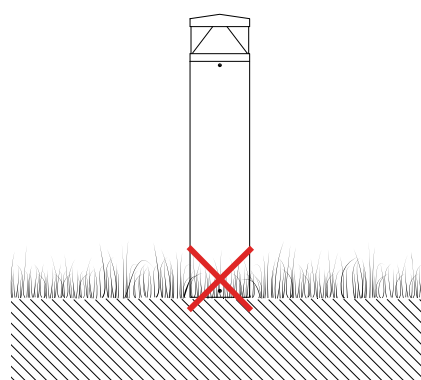

I-Ron







Famille / Family

I-Ron

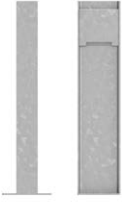

Power Led

up to 9W

up to 391 lm - 2700K/CRI 80

up to 420 lm - 3000K/CRI 80

up to 448 lm - 4000K/CRI 80

2200K available on request.

Finitions / Colours



90 Zinc

I-Ron

Description / Description

Borne d'extérieur avec une structure avec poutre IPE avec profil en H, en acier zingué par immersion à chaud qui lui confère une haute résistance à la corrosion. Grâce à son design particulier, le luminaire peut être utilisé également en tant que borne fixe architectonique. La source lumineuse LED est située sur la partie postérieure et est protégée par un diffuseur en plastique recouvert de zinc qui se situe sur la partie supérieure de la barre. Les composants électriques se trouvent sur la partie postérieure du luminaire. La borne peut être installée facilement au sol sur tout type de revêtement, à l'aide de chevilles ou en utilisant la plaque d'ancrage dédiée et les tire-fonds qui fixent solidement le luminaire au sol. Les vis de fixation sont en acier inoxydable AISI 316L.

Outdoor bollard with hot-dip zinc-coated IPE steel bar H-frame structure for high resistance to corrosion. Thanks to its unique design, the fixture can also be used as a fixed architectural bollard. The LED light source is located at the back of the fixture and is protected by a plastic diffuser covered by zinc, which is located on the upper part of the bar. The electric components are located at the back of the luminaire. The bollard can be easily installed on any kind of ground surface, directly with studs or through the dedicated fixing plate and bolts which solidly attach the luminaire to the ground. The fixing screws are made of AISI 316L stainless steel.

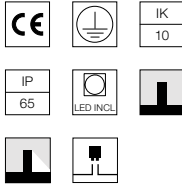
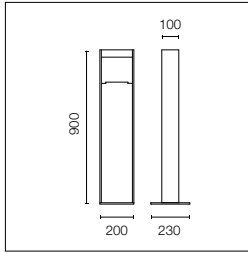

Source LED incluse. Source d'alimentation électrique intégrée 220-240V ON/OFF. Équipée de deux gaines pour des câbles 8mmϕ<math><13\text{mm}</math> pour des connections entrée-sortie. Peut être installée à l'aide de chevilles sur tout type de revêtement ou avec une plaque d'ancrage encastrable avec mortier, à commander séparément.

LED source included. Integrated electric power supply 220-240V ON/OFF. Equipped with two rubber cable guides (8ϕ<math><13\text{mm}</math> cables) for inlet-outlet connections. It can be installed on any ground using studs or a recessed fixing plate with mortar, to be ordered separately.

2200K disponible sur demande.

2200K available on request.

Power Led: 9W - 1011 lm \neq OUTPUT 391 lm - 2700K/CRI 80 - 220-240V / 9W - 1087 lm \neq OUTPUT 420 lm - 3000K/CRI 80 - 220-240V / 9W - 1162 lm \neq OUTPUT 448 lm - 4000K/CRI 80 - 220-240V

2700K

● FA1041060090 1.026,00 €

3000K

● FA1041040090 1.026,00 €

4000K

● FA1041970090 1.026,00 €

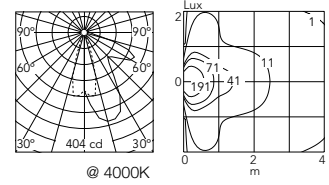

Plaque de boulons.

Base plate with bolt.

FA109

47,00 €

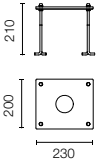

Dispositif de protection contre les surtensions. 275Vac. Courant de décharge maximal 10KA (8/20us). Courant de fonctionnement maximal 5A. Adapté pour les connexions en séries. IP66.

Surge protection device. 275Vac. Maximum discharge current 10KA (8/20us). Maximum operating current 5A. Suitable for series connection. IP66.

F990E00A000

116,00 €

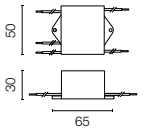

Méthode de fixation correcte

Borne fixée avec du ciment sur plinthe + vis de fixation adéquats

Correct Fixing Method

Bollard fixed on plinth + plug.

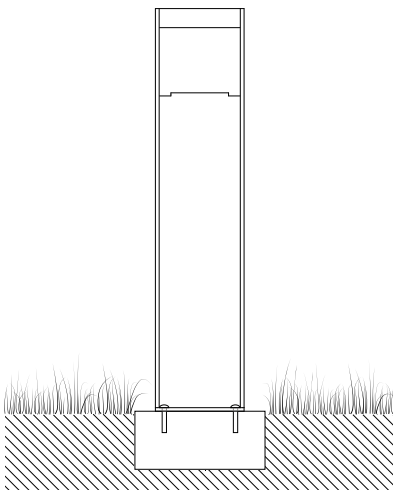

Méthode de fixation correcte

Borne fixée avec du ciment + plaque d'ancrage et tire-fonds.

Correct Fixing Method

Bollard fixed on plinth + fixing bolts.

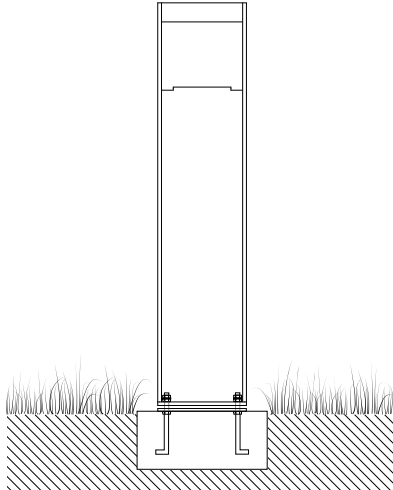

Méthode de fixation incorrecte

Ne pas fixer la borne directement au sol.

Incorrect Fixing Method

Do not fix the bollard directly on the ground.

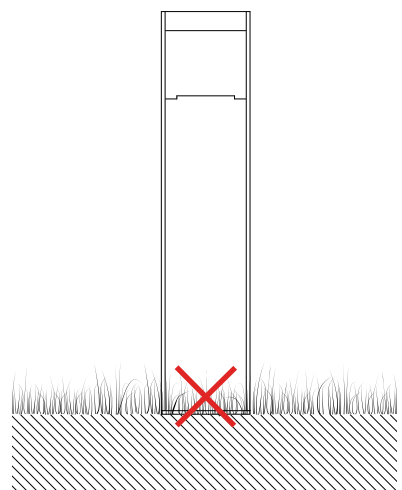

Talia



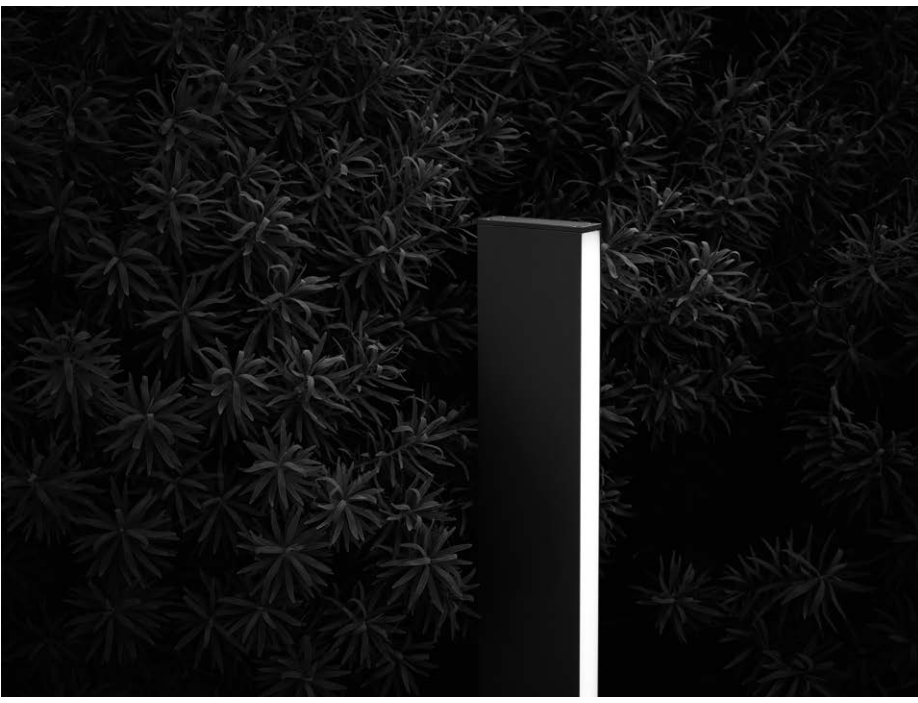



Famille / Family

Talia 360

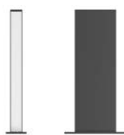

Low - Power Led

up to 4W
up to 73 lm - 2700K/CRI 80
up to 73 lm - 3000K/CRI 80
up to 73 lm - 4000K/CRI 80

* Net lumen output

Low - Power Led

up to 7W
up to 2x73 lm - 2700K/CRI 80
up to 2x73 lm - 3000K/CRI 80
up to 2x73 lm - 4000K/CRI 80

* Net lumen output

Talia 560

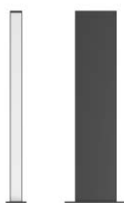

Low - Power Led

up to 6W
up to 123 lm - 2700K/CRI 80
up to 123 lm - 3000K/CRI 80
up to 123 lm - 4000K/CRI 80

* Net lumen output

Low - Power Led

up to 11W
up to 2x123 lm - 2700K/CRI 80
up to 2x123 lm - 3000K/CRI 80
up to 2x123 lm - 4000K/CRI 80

* Net lumen output

Finitions / Colours



01 White



06 Grey



12 Forest Green



18 Deep Brown



30 Black



33 Anthracite

Description / Description

Borne d'extérieur avec source LED. Disponible en deux hauteurs et en version avec émission de lumière monodirectionnelle ou bidirectionnelle. Structure en aluminium extrudé, tête en aluminium moulé, diffuseur en polycarbonate opale et résistant aux rayons UV. Le module LED linéaire est situé sur un cylindre de protection scellé avec du polycarbonate transparent et équipé d'une valve de compensation. Disponible en différentes finitions avec un revêtement à poudre double couche et une surface traitée par procédé de conversion chimique pour garantir une haute résistance à la corrosion. La borne peut être installée facilement au sol sur tout type de revêtement, à l'aide de chevilles ou en utilisant la plaque d'ancrage dédiée et les tire-fonds qui fixent solidement le luminaire au sol. Les vis de fixation sont en acier inoxydable AISI 316L.

Outdoor bollard with LED light source. Available in two heights and monodirectional or bidirectional light emission. Extruded aluminium body. Die-cast aluminium cap. UV-stabilized, opal polycarbonate diffuser. The linear LED module is housed in a sealed transparent polycarbonate cylinder with compensation valve. Available in different finishes with a double layer coating and a chemical conversion surface treatment to guarantee high resistance to corrosion. The bollard can be easily installed on any kind of ground surface, directly with studs or through the dedicated fixing plate and bolts which solidly attach the luminaire to the ground. The fixing screws are made of AISI 316L stainless steel.

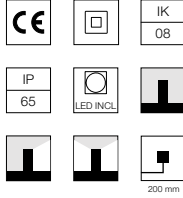
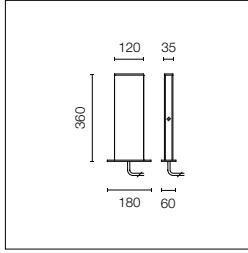
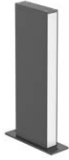

Source LED incluse. Source d'alimentation électrique intégrée 220-240V ON/OFF. Équipée d'un câble sortant de 2m en néoprène, et d'un kit avec des connecteurs sertissables et des gaines thermorétractables adhésives qui garantissent l'étanchéité de la connexion. Peut être installée à l'aide de chevilles sur tout type de revêtement ou avec une plaque d'ancrage encastrable avec mortier, à commander séparément.

LED source included. Integrated electric power supply 220-240V ON/OFF. The luminaire is equipped with a protruding, neoprene, two meter cable and a wiring kit with crimp connectors and adhesive heat-shrink tubing guaranteeing the water tightness of the connection. It can be installed on any ground using studs or a recessed fixing plate with mortar, to be ordered separately.

Single Emission

Power Led: 4W - 216 lm ≠ OUTPUT 73 lm - 2700K/CRI 80 - 220÷240V / 4W - 216 lm ≠ OUTPUT 73 lm - 3000K / CRI 80 - 220÷240V / 4W - 216 lm ≠ OUTPUT 73 lm - 4000K/CRI 80 - 220÷240V

2700K

○ FA50320601	243,00 €
● FA50320606	243,00 €
● FA50320612	243,00 €
● FA50320618	243,00 €
● FA50320630	243,00 €
● FA50320633	243,00 €

3000K

○ FA50300601.A	243,00 €
● FA50300606.A	243,00 €
● FA50300612.A	243,00 €
● FA50300618.A	243,00 €
● FA50300630.A	243,00 €
● FA50300633.A	243,00 €

4000K

○ FA50301101.A	243,00 €
● FA50301106.A	243,00 €
● FA50301112.A	243,00 €
● FA50301118.A	243,00 €
● FA50301130.A	243,00 €
● FA50301133.A	243,00 €

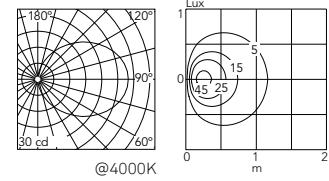

Double Emission

Power Led: 7W - 2x216 lm ≠ OUTPUT 2x73 lm - 2700K/CRI 80 - 220÷240V / 7W - 2x216 lm ≠ OUTPUT 2x73 lm - 4000K/CRI 80 - 220÷240V / 7W - 2x216 lm ≠ OUTPUT 2x73 lm - 4000K/CRI 80 - 220÷240V

2700K

○ FA50320801	303,00 €
● FA50320806	303,00 €
● FA50320812	303,00 €
● FA50320818	303,00 €
● FA50320830	303,00 €
● FA50320833	303,00 €

3000K

○ FA50300801	303,00 €
● FA50300806	303,00 €
● FA50300812	303,00 €
● FA50300818	303,00 €
● FA50300830	303,00 €
● FA50300833	303,00 €

4000K

○ FA50301201.A	303,00 €
● FA50301206.A	303,00 €
● FA50301212.A	303,00 €
● FA50301218.A	303,00 €
● FA50301230.A	303,00 €
● FA50301233.A	303,00 €

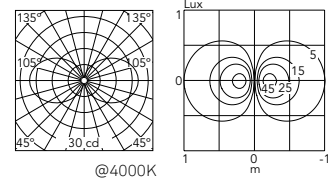

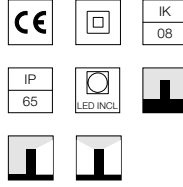
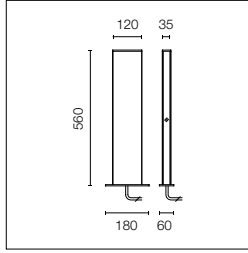
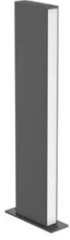

Source LED incluse. Source d'alimentation électrique intégrée 220-240V ON/OFF. Équipée d'un câble sortant de 2m en néoprène, et d'un kit avec des connecteurs sertissables et des gaines thermorétractables adhésives qui garantissent l'étanchéité de la connexion. Peut être installée à l'aide de chevilles sur tout type de revêtement ou avec une plaque d'ancrage encastrable avec mortier, à commander séparément.

LED source included. Integrated electric power supply 220-240V ON/OFF. The luminaire is equipped with a protruding, neoprene, two meter cable and a wiring kit with crimp connectors and adhesive heat-shrink tubing guaranteeing the water tightness of the connection. It can be installed on any ground using studs or a recessed fixing plate with mortar, to be ordered separately.

Single Emission

Power Led: 6W - 360 lm ≠ OUTPUT 123 lm - 2700K/CRI 80 - 220÷240V / 6W - 360 lm ≠ OUTPUT 123 lm - 3000K/CRI 80 - 220÷240V / 6W - 360 lm ≠ OUTPUT 123 lm - 4000K/CRI 80 - 220÷240V

2700K

- FA50320201 303,00 €
- FA50320206 303,00 €
- FA50320212 303,00 €
- FA50320218 303,00 €
- FA50320230 303,00 €
- FA50320233 303,00 €

3000K

- FA50300201.A 303,00 €
- FA50300206.A 303,00 €
- FA50300212.A 303,00 €
- FA50300218.A 303,00 €
- FA50300230.A 303,00 €
- FA50300233.A 303,00 €

4000K

- FA50300901 303,00 €
- FA50300906 303,00 €
- FA50300912 303,00 €
- FA50300918 303,00 €
- FA50300930 303,00 €
- FA50300933 303,00 €

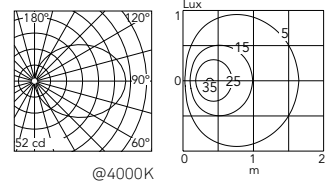

Double Emission

Power Led: 11W - 2x360 lm ≠ OUTPUT 2x123 lm - 2700K/CRI 80 - 220÷240V / 11W - 2x360 lm ≠ OUTPUT 2x123 lm - 3000K/CRI 80 - 220÷240V / 11W - 2x360 lm ≠ OUTPUT 2x123 lm - 4000K/CRI 80 - 220÷240V

2700K

- FA50320401 392,00 €
- FA50320406 392,00 €
- FA50320412 392,00 €
- FA50320418 392,00 €
- FA50320430 392,00 €
- FA50320433 392,00 €

3000K

- FA50300401.A 392,00 €
- FA50300406.A 392,00 €
- FA50300412.A 392,00 €
- FA50300418.A 392,00 €
- FA50300430.A 392,00 €
- FA50300433.A 392,00 €

4000K

- FA50301001.A 392,00 €
- FA50301006.A 392,00 €
- FA50301012.A 392,00 €
- FA50301018.A 392,00 €
- FA50301030.A 392,00 €
- FA50301033.A 392,00 €

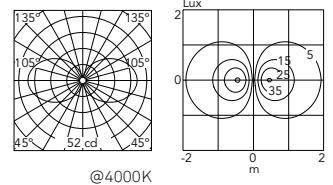

Talia: Accessoires / Accessories

Plaque de boulons.	Base plate with bolt.	FA139	26,00 €		
Dispositif de protection contre les surtensions. 275Vac. Courant de décharge maximal 10KA (8/20µs). Courant de fonctionnement maximal 5A. Adapté pour les connexions en séries. IP66.	Surge protection device. 275Vac. Maximum discharge current 10KA (8/20µs). Maximum operating current 5A. Suitable for series connection. IP66.	F990E00A000	116,00 €		
Système de jonction IP68 à 2 voies 4 pôles. (ø7±12mm câble).	2 way terminal block 4 poles IP68. (ø7±12mm cable).	F990C040000	25,00 €		

Méthode de fixation correcte

Borne fixée avec du ciment sur plinthe + vis de fixation adéquats

Correct Fixing Method

Bollard fixed on plinth + plug.

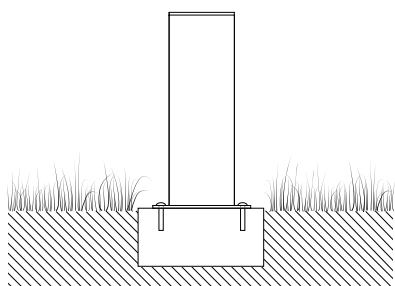

Méthode de fixation correcte

Borne fixée avec du ciment + plaque d'ancrage et tire-fonds.

Correct Fixing Method

Bollard fixed on plinth + fixing bolts.

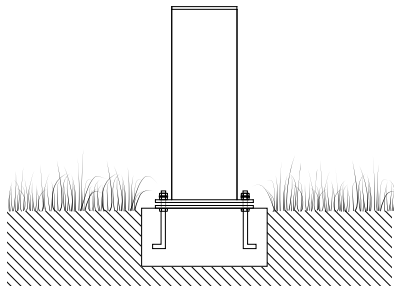

Méthode de fixation incorrecte

Ne pas fixer la borne directement au sol.

Incorrect Fixing Method

Do not fix the bollard directly on the ground.

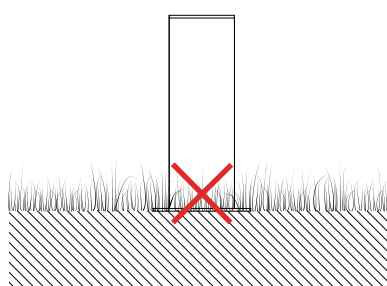

Real Matter

Designed by Piero Lissoni





Real Matter

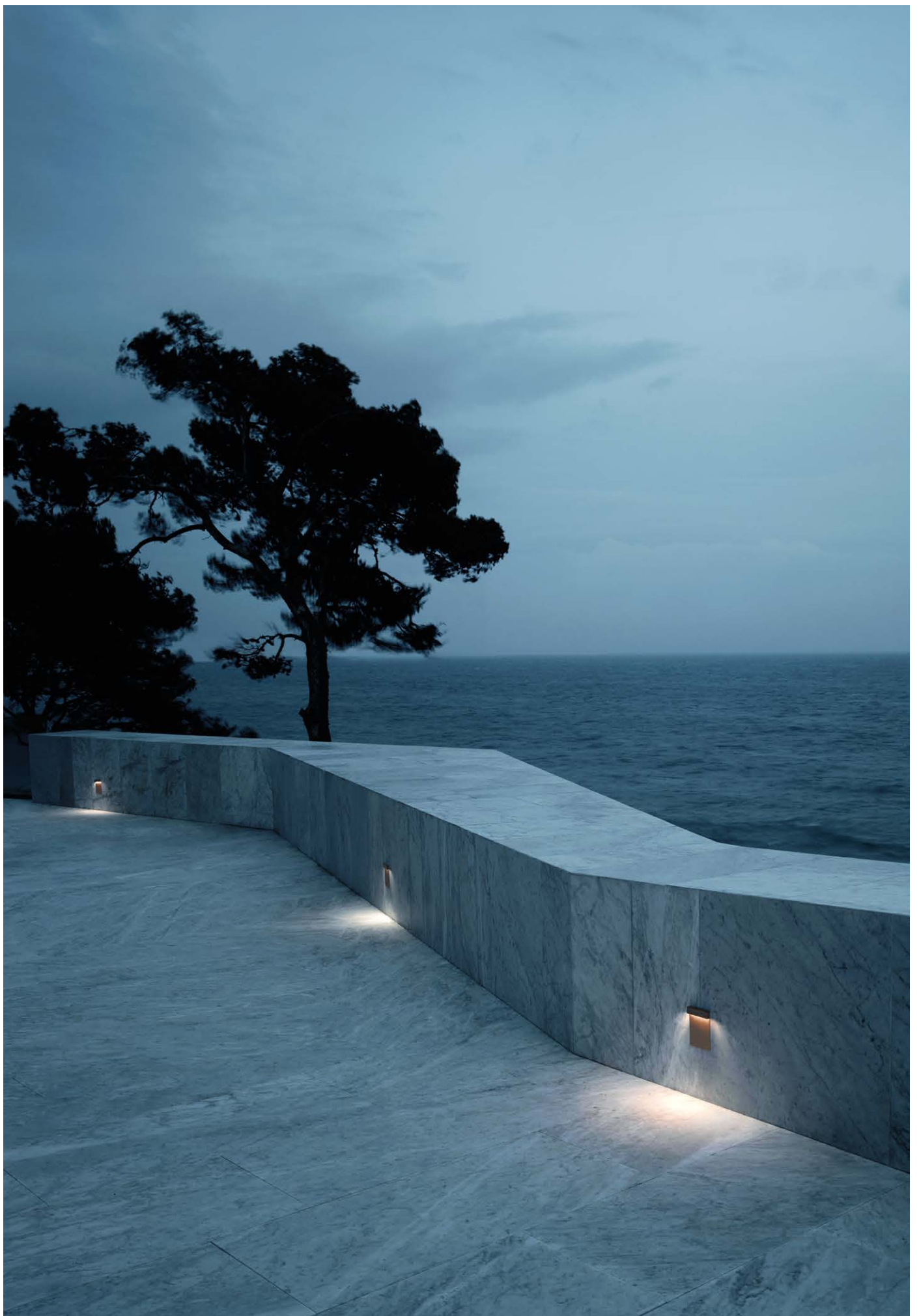

Famille / Family

Real Matter



Low - Power Led

3W

71 lm - 2700K/CRI 80

82 lm - 3000K/CRI 80

2200K available on request.

Finitions / Colours



44 Brushed Gold



47 Brushed Bronze



55 Brushed Stainless
Steel



66 Polished Copper

Description / Description

Applique encastrée d'extérieur à LED.

Corps en acier inox AISI 316L traité par procédé PVD (Physical Vapour Deposition). Grâce à ce traitement innovant, après polissage ou brossage selon la finition souhaitée, les surfaces de Real Matter sont recouvertes d'un léger film de métal comme le zirconium et le titane qui, en se mélangeant à l'acier au niveau moléculaire, en augmentent sa résistance mécanique et contre les agents atmosphériques et permettent de réaliser des finitions précieuses et durables.

Diffuseur en polycarbonate stabilisé aux rayons UV.

L'appareil est fourni avec deux câbles d'alimentation sortants L.200mm et avec un kit de connexion IP. Il est nécessaire d'utiliser un boîtier, à commander séparément.

Le driver d'alimentation 24V peut être installé à distance ou être placé après l'appareil dans le boîtier.

3 versions disponibles en fonction du type d'installation :

- sur surface en béton avec boîtier à encastrer.
- sur mur en Placoplatre avec ressorts fournis.
- sur les surfaces dures, le boîtier n'est pas nécessaire : l'appareil est directement collé sur la surface.

Luminaire for outdoor use for built-in installation on the wall with LED light source.

Body made of stainless steel AISI 316L treated with the PVD process (Physical Vapour Deposition). Thanks to this innovative treatment, after the polishing or brushing process, according to the finishing choice, the surfaces of Real Matter are coated with a thin film of metals such as zirconium and titanium which, combining with the steel at the molecular level, increase the characteristics of resistance to both mechanical and to atmospheric agents, allowing the realization of elegant and durable finishings.

UV-stabilized polycarbonate diffuser.

The luminaire is provided with two L 200 mm length outgoing power cables and with a kit for the hermetic IP connection. It is necessary to use an installation box, to be ordered separately.

24V power supply may be installed remotely or housed at the back of the luminaire in the box for 3 version available select the model suitable for your type of installation:

- in concrete surface with recessed box to.
- in plasterboard surface supplied with springs.
- on solid surface no recessed box needed, the fixtures is directly glued on the surface.

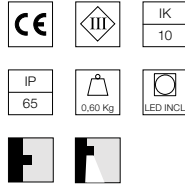
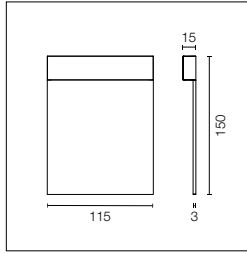

Alimentation électrique à distance 24V à commander séparément. Appareil fourni avec deux câbles d'alimentation de 200 mm et kit de connexion IP. Disponible en 3 versions (choisir le modèle en fonction du type d'installation) :

- sur surface en béton avec boîtier à encastrer à commander séparément.
- sur surface en Placoplatre (épaisseur mini 5mm - maxi 20mm) avec ressorts fournis.
- sur les surfaces dures, le boîtier n'est pas nécessaire : l'appareil est directement collé sur la surface (le type de colle doit être choisi par l'installateur en fonction du matériau sur lequel sera appliqué l'appareil).

Remote power supply 24V to be separately ordered. The fixture is prewired with 200mm cable and an IP connection kit. 3 version available (select the model suitable for your type of installation):

- in concrete surface with recessed box to be ordered separately.
- in plasterboard surface (surface thickness min 5mm-max20mm) model supplied with springs.
- on solid surface no recessed box needed, the fixtures is directly glued on the surface (type of gluing to be select by the operator based on the type of surface).

2200K disponible sur demande.

2200K available on request.

Low-Power Led: 3W - 180 lm ≠ FIXT 71 lm - 2700K/CRI 80 - 24V / 3W - 200 lm ≠ FIXT 82 lm - 3000K/CRI 80 - 24V

2700K

Installation en maçonnerie avec boîtier de réservation/
Installation in masonry with box for installation

● F5960044	382,00 €	● F5961044	382,00 €
● F5960047	382,00 €	● F5961047	382,00 €
● F5960055	365,00 €	● F5961055	365,00 €
● F5960066	382,00 €	● F5961066	382,00 €

Installation sur Placoplatre (min 5mm - max 20mm)/
Installation in plasterboard wall

● F5980044	382,00 €	● F5981044	382,00 €
● F5980047	382,00 €	● F5981047	382,00 €
● F5980055	365,00 €	● F5981055	365,00 €
● F5980066	382,00 €	● F5981066	382,00 €

Installation en maçonnerie sans boîtier de réservation/
Installation in masonry without box for installation

● F5970044	382,00 €	● F5971044	382,00 €
● F5970047	382,00 €	● F5971047	382,00 €
● F5970055	365,00 €	● F5971055	365,00 €
● F5970066	382,00 €	● F5971066	382,00 €

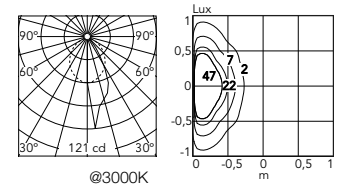

Boitier d'installation pour maçonnerie ou mur en béton. Box for installation for masonry or concrete wall.

F5962000

18,00 €

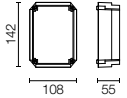

Installation en Maçonnerie avec Boitier de Réserve / Installation in Masonry with Box for Installation

boitier de réservation à ras de mur flush with the installation surface

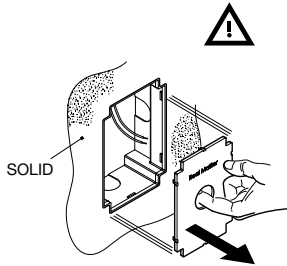

boitier d'installation / box for installation cod.F5962000

câblage avec alimentation à distance wiring with remote power supply

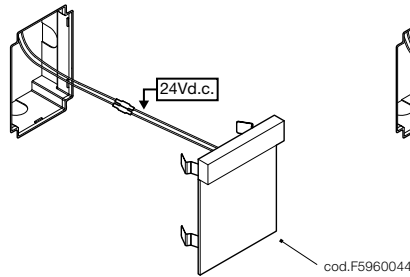

en option / optional câblage avec alimentation / wiring with power supply cod.RF25748

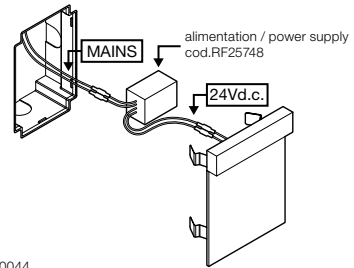

Installation sur Placoplatre / Installation in Plasterboard Wall

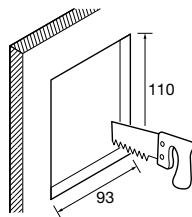

min 5 - max 20

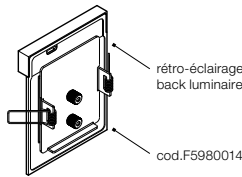

câblage avec alimentation à distance wiring with remote power supply

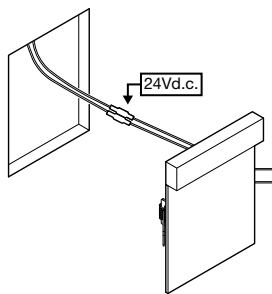

en option / optional câblage avec alimentation / wiring with power supply cod.RF25748

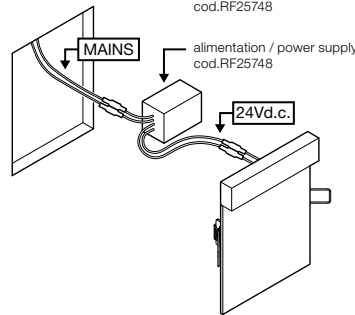

position correcte de l'écran cover correct positioning

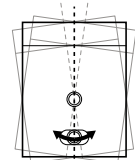

ajustable / adjustable

Installation en Maçonnerie sans Boitier de Réserve / Installation in Masonry without Box for Installation

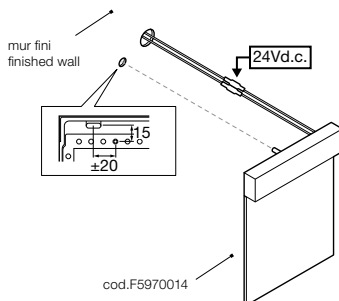

rétro-éclairage back luminaire

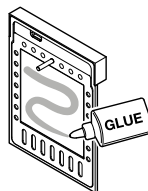



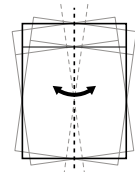





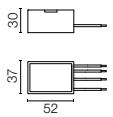

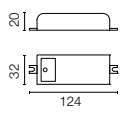

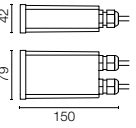
position correcte de l'écran cover correct positioning

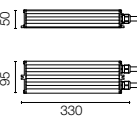

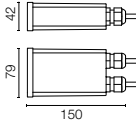
ajustable / adjustable

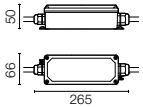
Real Matter: Appareillages électriques / Drivers

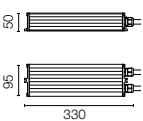
Équipement d'alimentation 24Vdc 8W / 110-240V IP65 Classe II selv.	Power supply 24Vdc 8W / 110-240V IP65 Class II selv.	*RF25748	63,00 €		
Peut être logé dans le boîtier de réservation F5962000.	It can be housed in installation box F5962000.				
Équipement d'alimentation pour installation à distance 24Vdc 10W / 110-240V IP20 Classe II selv.	Power supply for remote installation 24Vdc 10W / 110-240V IP20 Class II selv.	*RF25747	48,00 €		
Équipement d'alimentation pour installation à distance 24Vdc 20W / 220-240V IP67 Classe II selv.	Power supply for remote installation 24Vdc 20W / 220-240V IP67 Class II selv.	*RF25752	133,00 €		
Équipement d'alimentation pour installation à distance 24Vdc 50W / 120-240V IP67 Classe II selv.	Power supply for remote installation 24Vdc 50W / 120-240V IP67 Class II selv.	*F990B28A000	251,00 €		
Alimentation 24Vdc 35W / 120-270V IP67 Classe II selv.	Power supply 24Vdc 35W / 120-270V IP67 Class II selv.	*F990B23AZ00	180,00 €		
Équipement d'alimentation pour installation à distance 24Vdc 70W / 220-240V IP67 Classe II selv.	Power supply for remote installation 24Vdc 70W / 220-240V IP67 Class II selv.	*F990B27A000	212,00 €		
Équipement d'alimentation pour installation à distance 24Vdc 96W / 120-240V IP67 Classe II selv.	Power supply for remote installation 24Vdc 96W / 120-240V IP67 Class II selv.	*F990B29A000	300,00 €		

* Nombre maximum de luminaires par source d'alimentation / Maximum number of luminaires per power supply.

Nombre maximum de luminaires par source d'alimentation (220-240 V). Ces données doivent être vérifiées en prenant en compte les conditions spécifiques d'installation.	Maximum number of luminaires per power supply. (220-240 V). These data must be checked taking into account the specific installation conditions.	Acc.	
		Acc. RF25748	2
		Acc. RF25747	3
		Acc. RF25757	3
		Acc. RF25752	5
		Acc. F990B23AZ00	9
		Acc. F990B28A000	13
		Acc. F990B27A000	19
		Acc. F990B29A000	27

Real Matter: Appareillages électriques / Drivers

Équipement d'alimentation pour installation à distance 24Vdc 17W / 110-240V (15W@110V) IP20 Classe II selv.

Power supply for remote installation 24Vdc 17W / 110-240V (15W@110V) IP20 Class II selv.

*RF25750
 Dimmable 1-10V

96,00 €

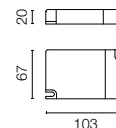

Équipement d'alimentation pour installation à distance 24Vdc 20W / 110-240Vdc (15W@110V) IP67 Classe II selv.

Power supply for remote installation 24Vdc 20W / 110-240Vdc (15W@110V) IP67 Class II selv.

*RF26387.A
 Dimmable DALI

159,00 €

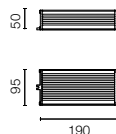

* Nombre maximum de luminaires par source d'alimentation / Maximum number of luminaires per power supply.

Nombre maximum de luminaires par source d'alimentation (220÷240 V). Ces données doivent être vérifiées en prenant en compte les conditions spécifiques d'installation.

Maximum number of luminaires per power supply. (220÷240 V). These data must be checked taking into account the specific installation conditions.

Acc. RF25750	4
Acc. RF26387.A	5

My Way

Designed by Piero Lissoni

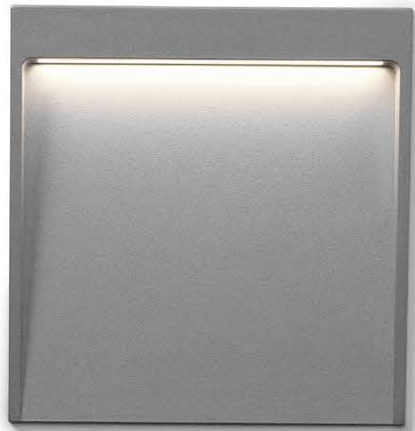

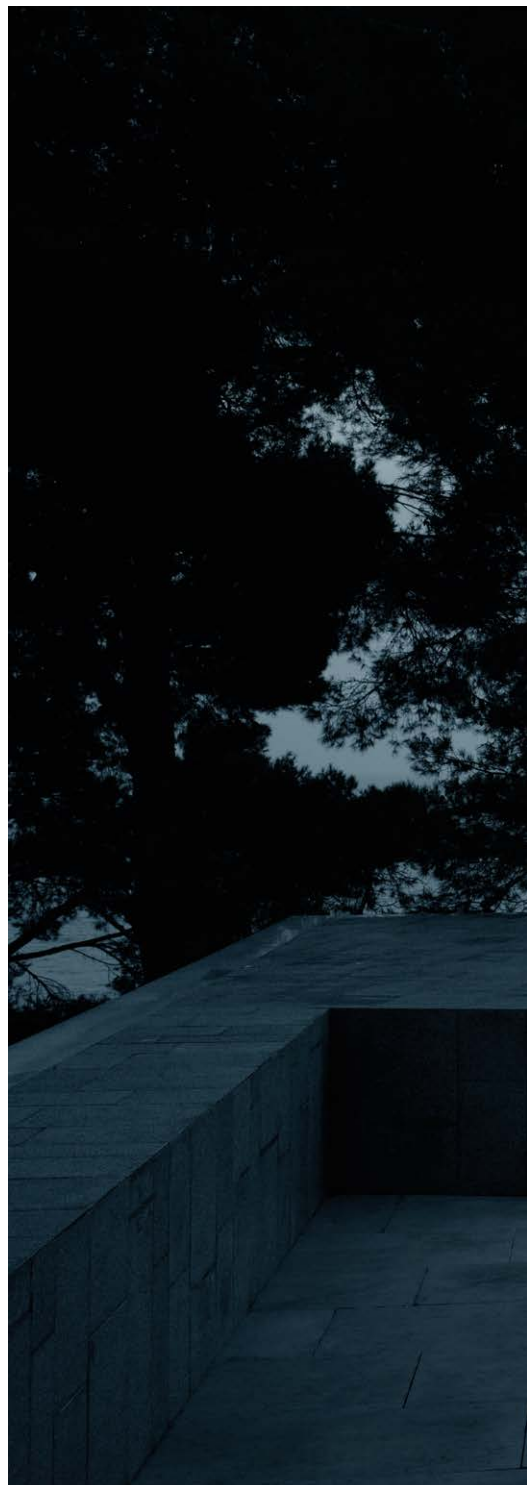



Famille / Family

My Way 110 x 100



Mid - Power Led

5W

188 lm - 2700K/CRI 80

211 lm - 3000K/CRI 80

221 lm - 4000K/CRI 80

My Way 110 x 200



Mid - Power Led

13W

657 lm - 2700K/CRI 80

763 lm - 3000K/CRI 80

801 lm - 4000K/CRI 80

My Way 210 x 200



Mid - Power Led

13W

669 lm - 2700K/CRI 80

777 lm - 3000K/CRI 80

817 lm - 4000K/CRI 80

Finitions / Colours



01 White



06 Grey

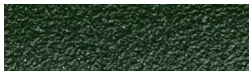

12 Forest Green



18 Deep Brown



30 Black



33 Anthracite

Description / Description

Applique encastrée d'extérieur à LED.

Corps en aluminium moulé sous pression EN AB-47100 (à faible teneur en cuivre).

Revêtement à haute résistance : après un traitement de sablage de tous les composants pour rendre la surface poreuse et garantir une meilleure adhérence de la peinture, le revêtement externe est appliqué en double couche avec des poudres selon le label QUALICOAT. La première couche de poudres époxydiques assure la résistance chimique et mécanique. La seconde couche de finition de poudres polyester garantit la résistance aux rayons UV et aux agents atmosphériques.

Les surfaces peintes sont traitées par lavages alcalins et acides, rincées à l'eau déminéralisée puis soumises à un traitement de conversion chimique pour les protéger de l'oxydation.

Diffuseur en polycarbonate satiné, stabilisé aux rayons UV, collé à la tête du produit pour garantir son étanchéité.

Luminaire for outdoor use for built-in installation on the wall with LED light source.

Aluminum die-cast body EN AB-47100 (low copper content). High-resistance coating: after a sandblasting treatment of all components to make the surface porous and ensure a greater adhesion of the paint, the external coating is applied with a double layer with epoxy powders according to the QUALICOAT standard. The first layer of epoxy powder gives chemical and mechanical resistance, the second finishing layer of polyester powder ensures resistance to UV rays and atmospheric agents.

The painted surfaces are treated with alkaline and acidic washes, then rinsed with demineralized water, subjected to a chemical conversion treatment to protect against oxidation. Frosted polycarbonate diffuser, UV-stabilised, glued to the head of the product to ensure a watertight seal.

My Way 110x100

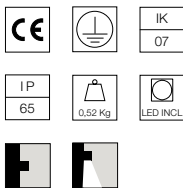
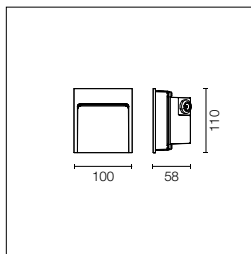

Alimentation 110/240V intégrée.
Pré-câblé avec câble sortant
en néoprène de 120 mm et
système de connexion sur câble
IP67.
Version dimmable sur demande.

Integrated 110/240V power
supply. Supplied with a 120 mm
length outgoing neoprene cable
and IP67 cable connection
system.
Dimmable version on request.

Mid-Power Led: 5W - 421 lm ≠ FIXT 188 lm - 2700K/CRI 80 - 100-240V / 5W - 490 lm ≠ FIXT 211 lm - 3000K/CRI 80 - 100-240V /
5W - 514 lm ≠ FIXT 221 lm - 4000K/CRI 80 - 100-240V

2700K

○ F4350001	198,00 €
● F4350006	198,00 €
● F4350012	198,00 €
● F4350018	198,00 €
● F4350030	198,00 €
● F4350033	198,00 €

3000K

○ F4351001	198,00 €
● F4351006	198,00 €
● F4351012	198,00 €
● F4351018	198,00 €
● F4351030	198,00 €
● F4351033	198,00 €

4000K

○ F4352001	198,00 €
● F4352006	198,00 €
● F4352012	198,00 €
● F4352018	198,00 €
● F4352030	198,00 €
● F4352033	198,00 €

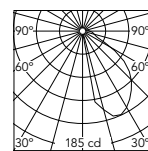

@4000K

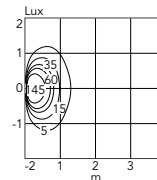

My Way 110x200

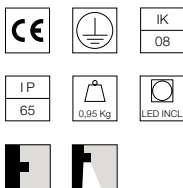
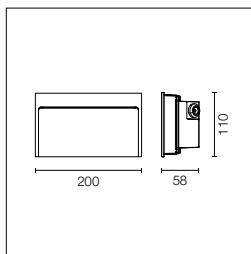

Alimentation 220/240V intégrée.
Pré-câblé avec câble sortant
en néoprène de 120 mm et
système de connexion sur câble
IP67.

Integrated 220/240V power
supply. Supplied with a 120 mm
length outgoing neoprene cable
and IP67 cable connection
system.

Mid-Power Led: 13W - 1357 lm ≠ FIXT 657 lm - 2700K/CRI 80 - 220-240V / 13W - 1577 lm ≠ FIXT 763 lm - 3000K/CRI 80 - 220-240V /
13W - 1656 lm ≠ FIXT 801 lm - 4000K/CRI 80 - 220-240V

2700K

Non Dimmable

○ F4353001	316,00 €
● F4353006	316,00 €
● F4353012	316,00 €
● F4353018	316,00 €
● F4353030	316,00 €
● F4353033	316,00 €

1-10V

○ F4353001-310	363,00 €
● F4353006-310	363,00 €
● F4353012-310	363,00 €
● F4353018-310	363,00 €
● F4353030-310	363,00 €
● F4353033-310	363,00 €

Dali

○ F4353001-300	363,00 €
● F4353006-300	363,00 €
● F4353012-300	363,00 €
● F4353018-300	363,00 €
● F4353030-300	363,00 €
● F4353033-300	363,00 €

3000K

Non Dimmable

○ F4354001	316,00 €
● F4354006	316,00 €
● F4354012	316,00 €
● F4354018	316,00 €
● F4354030	316,00 €
● F4354033	316,00 €

1-10V

○ F4354001-310	363,00 €
● F4354006-310	363,00 €
● F4354012-310	363,00 €
● F4354018-310	363,00 €
● F4354030-310	363,00 €
● F4354033-310	363,00 €

Dali

○ F4354001-300	363,00 €
● F4354006-300	363,00 €
● F4354012-300	363,00 €
● F4354018-300	363,00 €
● F4354030-300	363,00 €
● F4354033-300	363,00 €

4000K

Non Dimmable

○ F4355001	316,00 €
● F4355006	316,00 €
● F4355012	316,00 €
● F4355018	316,00 €
● F4355030	316,00 €
● F4355033	316,00 €

1-10V

○ F4355001-310	363,00 €
● F4355006-310	363,00 €
● F4355012-310	363,00 €
● F4355018-310	363,00 €
● F4355030-310	363,00 €
● F4355033-310	363,00 €

Dali

○ F4355001-300	363,00 €
● F4355006-300	363,00 €
● F4355012-300	363,00 €
● F4355018-300	363,00 €
● F4355030-300	363,00 €
● F4355033-300	363,00 €

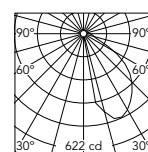

400mm @4000K

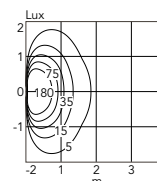

Camouflage

Designed by Piero Lissoni



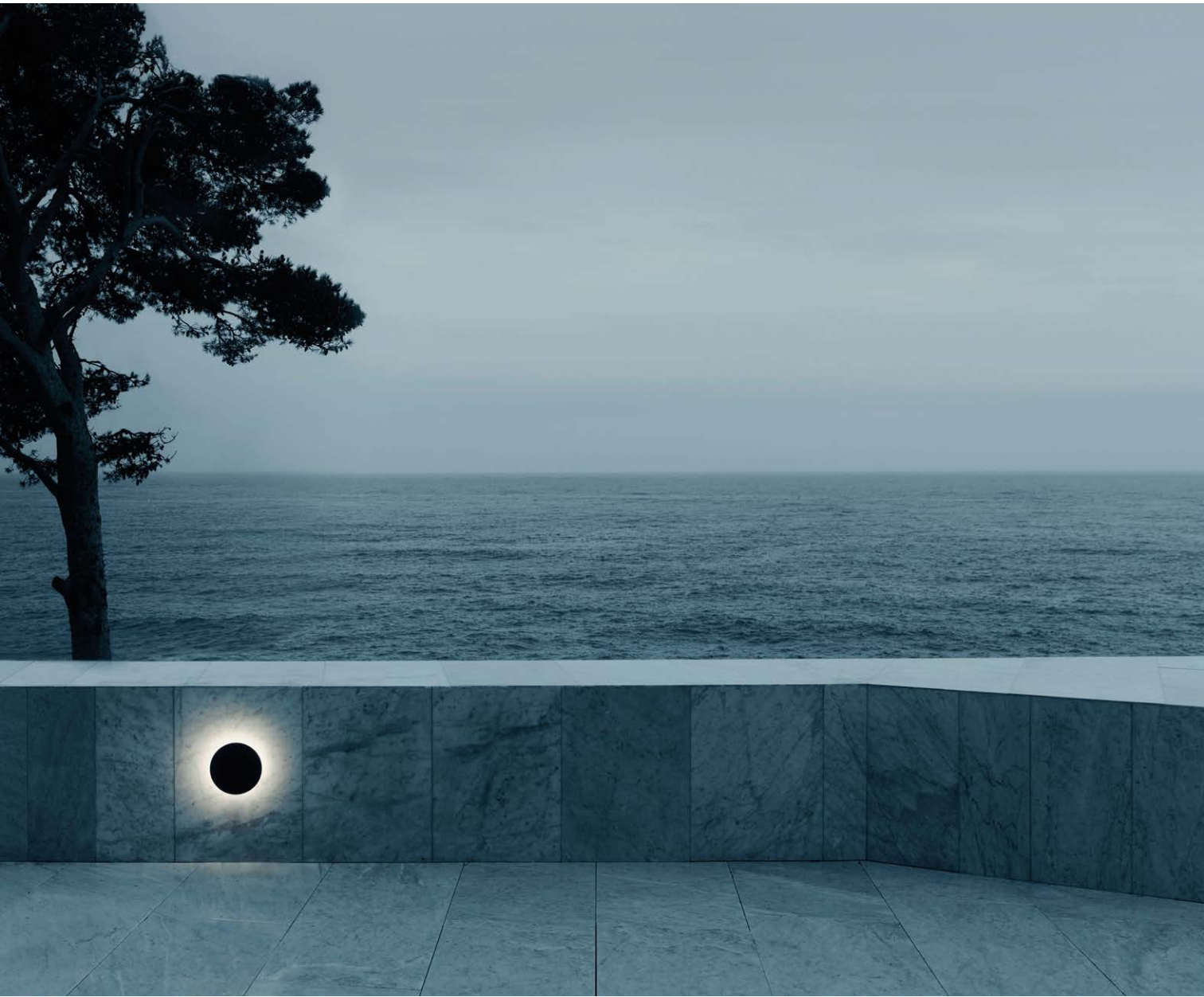

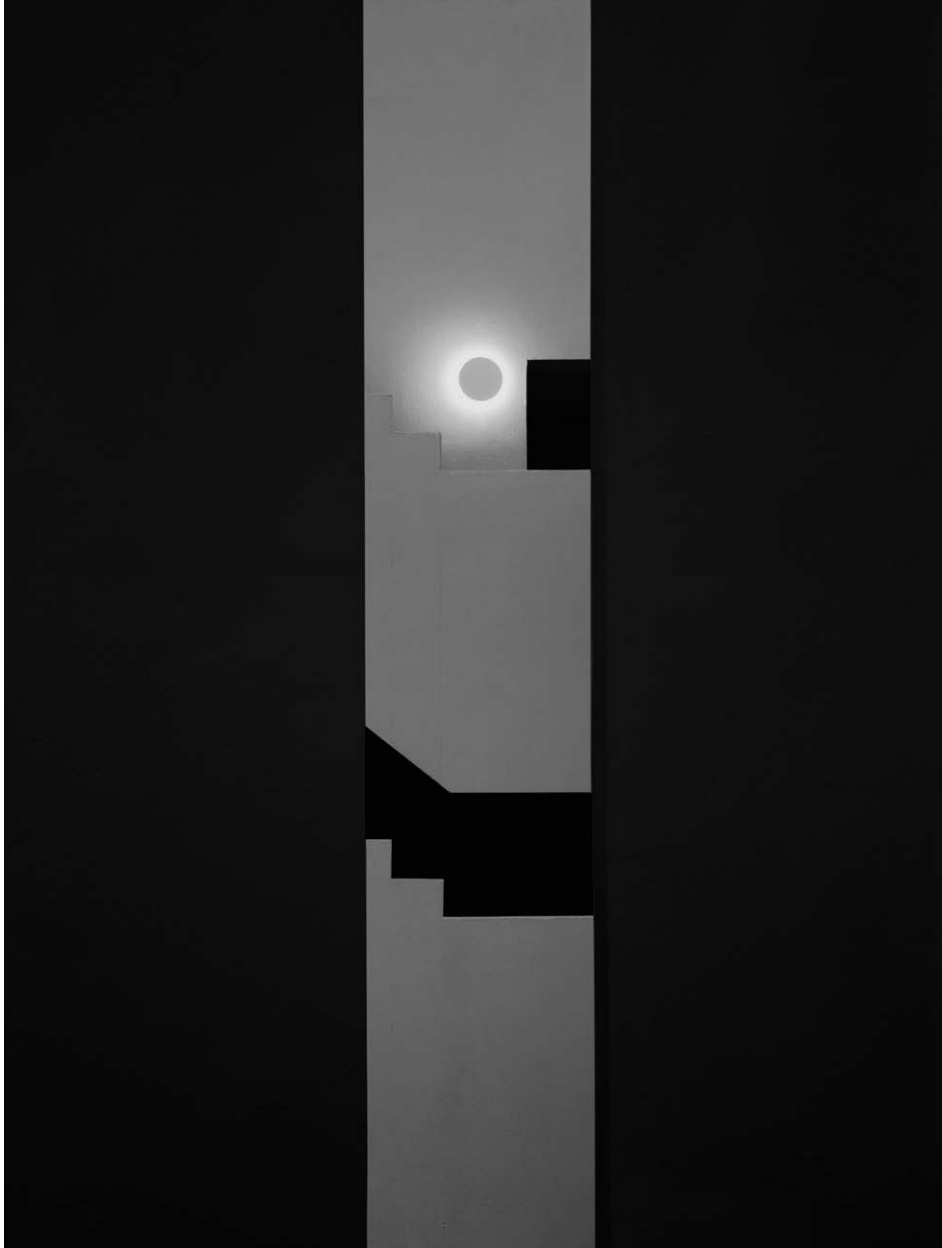

Camouflage

Famille / Family

Camouflage 140



Mid - Power Led

8W

474 lm - 2700K/CRI 80

551 lm - 3000K/CRI 80

579 lm - 4000K/CRI 80

Camouflage 240



Mid - Power Led

12W

773 lm - 2700K/CRI 80

898 lm - 3000K/CRI 80

944 lm - 4000K/CRI 80

Finitions / Colours

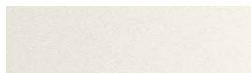

00 Primer



01 White



06 Grey

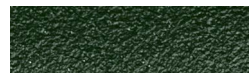

12 Forest Green



18 Deep Brown



30 Black



33 Anthracite

Camouflage Stone



87 Basaltina Stone



89 Concrete



90 Crema d'Orcia Stone

Description / Description

Collection d'appliques murales d'extérieur à LED
Corps dissipateur en aluminium avec diffuseur en polycarbonate transparent.

Les finitions pierre Crema d'Orcia et Basaltina sont fabriquées en fixant à l'aide d'une colle à très haute résistance, une plaque de pierre créée par processus d'usinage.

La finition béton est fabriquée en fixant avec une colle monocomposant à haute résistance, une plaque de ciment collé renforcé par fibre de verre. La version Apprêt est peinte après installation, avec des solutions aqueuses classiques (stucs, peintures à l'eau) pour garantir une meilleure homogénéité avec l'architecture. Les versions en aluminium sont recouvertes d'un revêtement à haute résistance : après un traitement par sablage de tous les composants pour rendre la surface poreuse et garantir une meilleure adhérence de la peinture, le revêtement externe est appliqué en deux couches avec poudres selon le label QUALICOAT. La première couche de poudres époxydiques assure la résistance chimique et mécanique; la seconde couche de finition de poudres polyester assure la résistance aux rayons UV et aux agents atmosphériques.

Les surfaces peintes sont traitées par lavages alcalins et acides, rincées à l'eau déminéralisée puis soumises à un traitement de conversion chimique pour les protéger de l'oxydation.

Sous réserve d'évaluation commerciale et technique, il est possible de réaliser des versions personnalisées sur demande, avec d'autres matériaux.

Collection of products for outdoor use, for wall installation with LED light source

Dissipating aluminum body with diffuser in transparent polycarbonate.

The Crema d'Orcia and Basaltina stone finishes are made by fastening high-strength, high-resistance adhesive to a stone plate created by means of mechanical machining from a solid block.

The concrete finishing is made by fastening a poured cement plate reinforced with fiberglass using a single component high strength, high-resistance adhesive. The Primer version is painted after installation with normal water-based colors (tempera, stucco, water-based paints) to ensure maximum uniformity with the architecture.

The aluminum versions are finished with a high-resistance coating: after a sandblasting treatment of all components to make the surface porous and ensure a greater adhesion of the paint, the external coating is applied with a double layer with epoxy powders according to the QUALICOAT standard. The first layer of epoxy powder gives chemical and mechanical resistance, the second finishing layer of polyester powder ensures resistance to UV rays and atmospheric agents.

The painted surfaces are treated with alkaline and acidic washes, then rinsed with demineralized water, subjected to a chemical conversion treatment to protect against oxidation. Upon commercial and technical evaluation, it is possible to create customized versions with other materials on request.

Camouflage 140

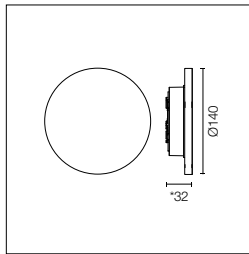

*Concrete, crema d'orcio, basaltina H = 35 mm.

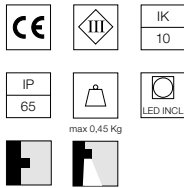

Alimentation à distance 24V à commander séparément. Câble d'alimentation de 100 mm fourni. Le driver peut être installé à distance (le boîtier n'est pas nécessaire) ou placé après l'appareil à l'aide du boîtier optionnel adéquat.

24V remote power supply to be ordered separately. Includes power cable of 100 mm. The power supply can be installed remotely (installation box not required) or housed at the back of the luminaire in the optional installation box.

Mid-Power Led: 8W - 786 lm ≠ FIXT 474 lm - 2700K/CRI 80 - 24V / 8W - 913 lm ≠ FIXT 551 lm - 3000K/CRI 80 - 24V / 8W - 960 lm ≠ FIXT 579 lm - 4000K/CRI 80 - 24V

2700K

3000K

4000K

● F1310000	222,00 €
○ F1310001	222,00 €
● F1310006	222,00 €
● F1310012	222,00 €
● F1310018	222,00 €
● F1310030	222,00 €
● F1310033	222,00 €
● F1310087	370,00 €
● F1310089	308,00 €
● F1310090	370,00 €

● F1311000	222,00 €
○ F1311001	222,00 €
● F1311006	222,00 €
● F1311012	222,00 €
● F1311018	222,00 €
● F1311030	222,00 €
● F1311033	222,00 €
● F1311087	370,00 €
● F1311089	308,00 €
● F1311090	370,00 €

● F1312000	222,00 €
○ F1312001	222,00 €
● F1312006	222,00 €
● F1312012	222,00 €
● F1312018	222,00 €
● F1312030	222,00 €
● F1312033	222,00 €
● F1312087	370,00 €
● F1312089	308,00 €
● F1312090	370,00 €

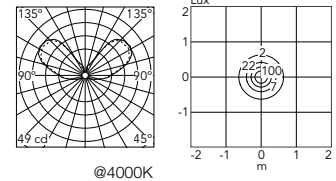

Dimmable 1-10V with code RF25750
Dimmable Dali with code RF26387.A

Camouflage 240

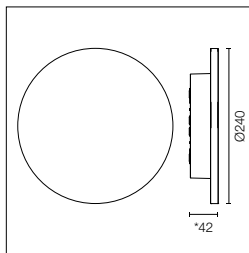

*Concrete, crema d'orcio, basaltina H = 48 mm.

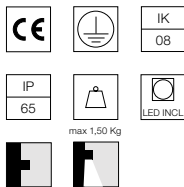

Alimentation 220/240V intégrée. Pré-câblé avec câble sortant en néoprène de 1000 mm. Version 110V sur demande.

Integrated 220/240V power supply. Supplied with a 1000 mm length outgoing neoprene cable. Version 110V upon request.

Mid-Power Led: 12W - 1281 lm ≠ FIXT 773 lm - 2700K/CRI 80 - 220-240V / 12W - 1488 lm ≠ FIXT 898 lm - 3000K/CRI 80 - 220-240V / 12W - 1563 lm ≠ FIXT 944 lm - 4000K/CRI 80 - 220-240V

2700K

3000K

4000K

Non Dimmable	
● F1315000	357,00 €
○ F1315001	357,00 €
● F1315006	357,00 €
● F1315012	357,00 €
● F1315018	357,00 €
● F1315030	357,00 €
● F1315033	357,00 €
● F1315087	515,00 €
● F1315089	446,00 €
● F1315090	515,00 €
1-10V	
● F1315000-310	446,00 €
○ F1315001-310	446,00 €
● F1315006-310	446,00 €
● F1315012-310	446,00 €
● F1315018-310	446,00 €
● F1315030-310	446,00 €
● F1315033-310	446,00 €
● F1315087-310	594,00 €
● F1315089-310	533,00 €
● F1315090-310	594,00 €
Dali	
● F1315000-300	446,00 €
○ F1315001-300	446,00 €
● F1315006-300	446,00 €
● F1315012-300	446,00 €
● F1315018-300	446,00 €
● F1315030-300	446,00 €
● F1315033-300	446,00 €
● F1315087-300	594,00 €
● F1315089-300	533,00 €
● F1315090-300	594,00 €

Non Dimmable	
● F1316000	357,00 €
○ F1316001	357,00 €
● F1316006	357,00 €
● F1316012	357,00 €
● F1316018	357,00 €
● F1316030	357,00 €
● F1316033	357,00 €
● F1316087	515,00 €
● F1316089	446,00 €
● F1316090	515,00 €
1-10V	
● F1316000-310	446,00 €
○ F1316001-310	446,00 €
● F1316006-310	446,00 €
● F1316012-310	446,00 €
● F1316018-310	446,00 €
● F1316030-310	446,00 €
● F1316033-310	446,00 €
● F1316087-310	594,00 €
● F1316089-310	533,00 €
● F1316090-310	594,00 €
Dali	
● F1316000-300	446,00 €
○ F1316001-300	446,00 €
● F1316006-300	446,00 €
● F1316012-300	446,00 €
● F1316018-300	446,00 €
● F1316030-300	446,00 €
● F1316033-300	446,00 €
● F1316087-300	594,00 €
● F1316089-300	533,00 €
● F1316090-300	594,00 €

Non Dimmable	
● F1317000	357,00 €
○ F1317001	357,00 €
● F1317006	357,00 €
● F1317012	357,00 €
● F1317018	357,00 €
● F1317030	357,00 €
● F1317033	357,00 €
● F1317087	515,00 €
● F1317089	446,00 €
● F1317090	515,00 €
1-10V	
● F1317000-310	446,00 €
○ F1317001-310	446,00 €
● F1317006-310	446,00 €
● F1317012-310	446,00 €
● F1317018-310	446,00 €
● F1317030-310	446,00 €
● F1317033-310	446,00 €
● F1317087-310	594,00 €
● F1317089-310	533,00 €
● F1317090-310	594,00 €
Dali	
● F1317000-300	446,00 €
○ F1317001-300	446,00 €
● F1317006-300	446,00 €
● F1317012-300	446,00 €
● F1317018-300	446,00 €
● F1317030-300	446,00 €
● F1317033-300	446,00 €
● F1317087-300	594,00 €
● F1317089-300	533,00 €
● F1317090-300	594,00 €

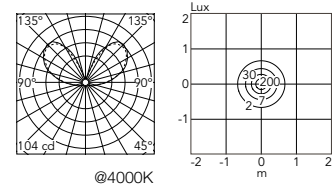

Camouflage 140: Accessoires / Accessories

Dispositif de protection contre les surtensions. 275Vac. Courant de décharge maximal 10KA (8/20us). Courant de fonctionnement maximal 5A. Adapté pour les connexions en séries. IP66.

Surge protection device. 275Vac. Maximum discharge current 10KA (8/20us). Maximum operating current 5A. Suitable for series connection. IP66.

F990E00A000

116,00 €

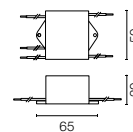

Boitier.

Box for installation.

F1318000

12,00 €

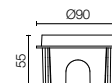

Fixation au Mur / Installation on Wall

Option 1

Sans boîtier de réservation / Surface installation

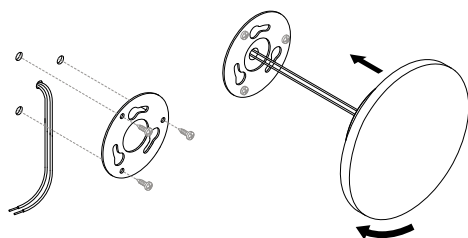

alimentation à distance 24Vdc
remote power supply 24Vdc

Option 2

Boîtier de réservation encastré / Recessed box installation

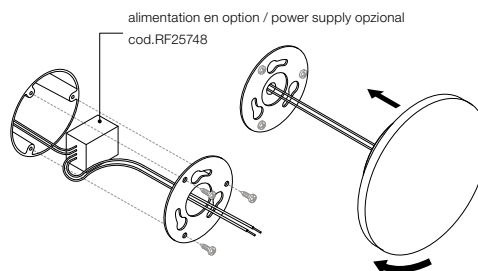









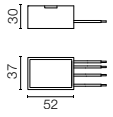

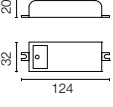

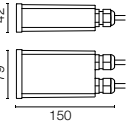

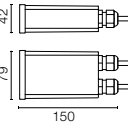

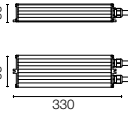
alimentation en option / power supply optional
cod.RF25748

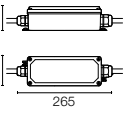
boîtier de réservation à ras de mur
flush with the installation surface

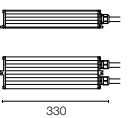
boîtier / instllation box
cod.F1318000

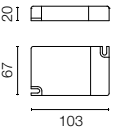
Camouflage: Appareillages électriques / Drivers

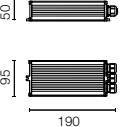
Équipement d'alimentation pour installation à distance 24Vdc 8W / 110-240V IP65 Classe II selv. Peut être logé dans le boîtier de réservation F1318000.	Power supply for remote installation 24Vdc 8W / 110-240V IP65 Class II selv. It can be housed in installation box F1318000.	*RF25748	63,00 €		
Équipement d'alimentation pour installation à distance 24Vdc 10W / 110-240V IP20 Classe II selv.	Power supply for remote installation 24Vdc 10W / 110-240V IP20 Class II selv.	*RF25747	48,00 €		
Équipement d'alimentation pour installation à distance 24Vdc 20W / 220-240V IP67 Classe II selv.	Power supply for remote installation 24Vdc 20W / 220-240V IP67 Class II selv.	*RF25752	133,00 €		
Alimentation 24Vdc 35W / 120-270V IP67 Classe II selv.	Power supply 24Vdc 35W / 120-270V IP67 Class II selv.	*F990B23AZ00	180,00 €		
Équipement d'alimentation pour installation à distance 24Vdc 50W / 120-240V IP67 Classe II selv.	Power supply for remote installation 24Vdc 50W / 120-240V IP67 Class II selv.	*F990B28A000	251,00 €		
Équipement d'alimentation pour installation à distance 24Vdc 70W / 220-240V IP67 Classe II selv.	Power supply for remote installation 24Vdc 70W / 220-240V IP67 Class II selv.	*F990B27A000	212,00 €		
Équipement d'alimentation pour installation à distance 24Vdc 96W / 120-240V IP67 Classe II selv.	Power supply for remote installation 24Vdc 96W / 120-240V IP67 Class II selv.	*F990B29A000	300,00 €		
Équipement d'alimentation pour installation à distance 24Vdc 17W / 110-240V (15W@110V) IP20 Classe II selv.	Power supply for remote installation 24Vdc 17W / 110-240V (15W@110V) IP20 Class II selv.	*RF25750  Dimmable 1-10V	96,00 €		
Équipement d'alimentation pour installation à distance 24Vdc 20W / 110-240Vdc (15W@110V) IP67 Classe II selv.	Power supply for remote installation 24Vdc 20W / 110-240Vdc (15W@110V) IP67 Class II selv.	*RF26387.A  Dimmable DALI	159,00 €		

* Nombre maximum de luminaires par source d'alimentation / Maximum number of luminaires per power supply.

Nombre maximum de luminaires par source d'alimentation (220-240 V). Ces données doivent être vérifiées en prenant en compte les conditions spécifiques d'installation.

Maximum number of luminaires per power supply. (220-240 V). These data must be checked taking into account the specific installation conditions.

Acc. RF25748	1	Acc. F990B28A000	5
Acc. RF25747	1	Acc. F990B27A000	7
Acc. RF25757	1	Acc. F990B29A000	9
Acc. RF25752	2	Acc. RF25750	2
Acc. F990B23AZ00	3	Acc. RF26387.A	2

Climber

Designed by Piero Lissoni







Climber

Famille / Family

Climber 87



**Down
Power Led**

7W
387 lm - 2700K/CRI 80
419 lm - 3000K/CRI 80
451 lm - 4000K/CRI 80
2200K available on request.

**Up&Down
Power Led**

12W
2x387 lm - 2700K/CRI 80
2x419 lm - 3000K/CRI 80
2x451 lm - 4000K/CRI 80
2200K available on request.

Climber 175

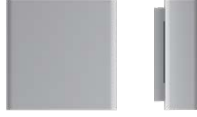

**Down
Power Led**

12W
721 lm - 2700K/CRI 80
781 lm - 3000K/CRI 80
841 lm - 4000K/CRI 80
2200K available on request.

**Up&Down
Power Led**

21W
2x721 lm - 2700K/CRI 80
2x781 lm - 3000K/CRI 80
2x841 lm - 4000K/CRI 80
2200K available on request.

Climber 275



**Down
Power Led**

21W
1240 lm - 2700K/CRI 80
1344 lm - 3000K/CRI 80
1447 lm - 4000K/CRI 80
2200K available on request.

**Up&Down
Power Led**

40W
2x1240 lm - 2700K/CRI 80
2x1344 lm - 3000K/CRI 80
2x1447 lm - 4000K/CRI 80
2200K available on request.

Finitions / Colours



01 White

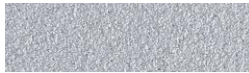

06 Grey



12 Forest Green



18 Deep Brown



30 Black



33 Anthracite

Description / Description

Applique encastrée d'extérieur à LED

Versions bi-émission et mono émission vers le bas.

Corps en aluminium moulé sous pression EN AB-47100, à faible teneur en cuivre, avec boîtier d'optiques asymétrique: l'optique dans la partie inférieure est placée à l'arrière et protégée par un obturateur pour limiter l'éblouissement et augmenter le confort visuel. Dans la version bi-émission, le verre de fermeture de l'optique supérieure est à ras du bord de la lampe pour éviter les résidus d'eau.

Les diffuseurs en verre microtexturée sont collés pour garantir l'imperméabilité, et texturisés pour assurer l'uniformité du faisceau lumineux généré par chaque LED, tout en maintenant la meilleure efficacité lumineuse.

Revêtement à haute résistance : après un traitement de sablage de tous les composants pour rendre la surface poreuse et garantir une meilleure adhérence de la peinture, le revêtement externe est appliqué en double couche avec des poudres selon le label QUALICOAT. La première couche de poudres epoxydiques assure la résistance chimique et mécanique. La seconde couche de finition de poudres polyester garantit la résistance aux rayons UV et aux agents atmosphériques.

Les surfaces peintes sont traitées par lavages alcalins et acides, rincées à l'eau déminéralisée puis soumises à un traitement de conversion chimique pour les protéger de l'oxydation.

Luminaire for outdoor use for installation on the wall with LED light supply.

Bi-emission and mono-emission versions pointing downwards.

Aluminum die-cast body EN AB-47100, low copper content with asymmetrical optics housing: the optics in the lower part is retracted and protected by a shutter to restrict annoying glare and maximize visual comfort. In the bi-emission version, the glass of the closure of the upper optics is flush with the edge of the light in order to prevent water deposits.

The micro-texturized glass diffusers are glued to ensure water resistance and textured to ensure a uniform light beam generated by each single LED, maintaining excellent luminous efficiency.

High-resistance coating: after a sandblasting treatment of all components to make the surface porous and ensure a greater adhesion of the paint, the external coating is applied with a double layer with epoxy powders according to the QUALICOAT standard. The first layer of epoxy powder gives chemical and mechanical resistance, the second finishing layer of polyester powder ensures resistance to UV rays and atmospheric agents.

The painted surfaces are treated with alkaline and acidic washes, then rinsed with demineralized water, subjected to a chemical conversion treatment to protect against oxidation.

Climber 87 Down

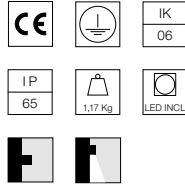
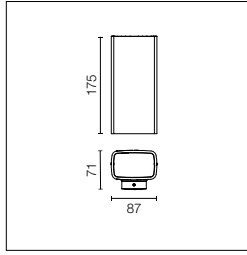

Alimentation 110/240V intégrée.
Pré-câblé avec câble sortant en néoprène de 80 mm.
Version à émission simple vers le haut. Disponible sur demande.

Integrated 110/240V power supply.
Supplied with an 80 mm length outgoing neoprene cable.
Upwards, single emission version, available upon request.

2200K disponible sur demande.

2200K available on request.

Power Led: 7W - 432 lm ≠ *FIXT 387 lm - 2700K/CRI 80 - 110-240V / 7W - 468 lm ≠ *FIXT 419 lm - 3000K/CRI 80 - 110-240V / 7W - 504 lm ≠ *FIXT 451 lm - 4000K/CRI 80 - 110-240V / *FIXT lm = Spot Optic

Optic Spot

2700K

Non Dimmable

○ F1110001.A	333,00 €
● F1110006.A	333,00 €
● F1110012.A	333,00 €
● F1110018.A	333,00 €
● F1110030.A	333,00 €
● F1110033.A	333,00 €
1-10V	
○ F1110001-310.A	431,00 €
● F1110006-310.A	431,00 €
● F1110012-310.A	431,00 €
● F1110018-310.A	431,00 €
● F1110030-310.A	431,00 €
● F1110033-310.A	431,00 €
Dali	
○ F1110001-300.A	431,00 €
● F1110006-300.A	431,00 €
● F1110012-300.A	431,00 €
● F1110018-300.A	431,00 €
● F1110030-300.A	431,00 €
● F1110033-300.A	431,00 €

3000K

Non Dimmable

○ F1112001.A	333,00 €
● F1112006.A	333,00 €
● F1112012.A	333,00 €
● F1112018.A	333,00 €
● F1112030.A	333,00 €
● F1112033.A	333,00 €
1-10V	
○ F1112001-310.A	431,00 €
● F1112006-310.A	431,00 €
● F1112012-310.A	431,00 €
● F1112018-310.A	431,00 €
● F1112030-310.A	431,00 €
● F1112033-310.A	431,00 €
Dali	
○ F1112001-300.A	431,00 €
● F1112006-300.A	431,00 €
● F1112012-300.A	431,00 €
● F1112018-300.A	431,00 €
● F1112030-300.A	431,00 €
● F1112033-300.A	431,00 €

4000K

Non Dimmable

○ F1114001.A	333,00 €
● F1114006.A	333,00 €
● F1114012.A	333,00 €
● F1114018.A	333,00 €
● F1114030.A	333,00 €
● F1114033.A	333,00 €
1-10V	
○ F1114001-310.A	431,00 €
● F1114006-310.A	431,00 €
● F1114012-310.A	431,00 €
● F1114018-310.A	431,00 €
● F1114030-310.A	431,00 €
● F1114033-310.A	431,00 €
Dali	
○ F1114001-300.A	431,00 €
● F1114006-300.A	431,00 €
● F1114012-300.A	431,00 €
● F1114018-300.A	431,00 €
● F1114030-300.A	431,00 €
● F1114033-300.A	431,00 €

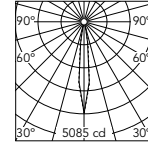

Beam Angle: 14°

h(m)	Et(x)	D(m)
1	5085	0.23
2	1271	0.47
3	565	0.70
4	318	0.93
5	203	1.17

@4000K

Optic Flood

2700K

Non Dimmable

○ F1111001.A	333,00 €
● F1111006.A	333,00 €
● F1111012.A	333,00 €
● F1111018.A	333,00 €
● F1111030.A	333,00 €
● F1111033.A	333,00 €
1-10V	
○ F1111001-310.A	431,00 €
● F1111006-310.A	431,00 €
● F1111012-310.A	431,00 €
● F1111018-310.A	431,00 €
● F1111030-310.A	431,00 €
● F1111033-310.A	431,00 €
Dali	
○ F1111001-300.A	431,00 €
● F1111006-300.A	431,00 €
● F1111012-300.A	431,00 €
● F1111018-300.A	431,00 €
● F1111030-300.A	431,00 €
● F1111033-300.A	431,00 €

3000K

Non Dimmable

○ F1113001.A	333,00 €
● F1113006.A	333,00 €
● F1113012.A	333,00 €
● F1113018.A	333,00 €
● F1113030.A	333,00 €
● F1113033.A	333,00 €
1-10V	
○ F1113001-310.A	431,00 €
● F1113006-310.A	431,00 €
● F1113012-310.A	431,00 €
● F1113018-310.A	431,00 €
● F1113030-310.A	431,00 €
● F1113033-310.A	431,00 €
Dali	
○ F1113001-300.A	431,00 €
● F1113006-300.A	431,00 €
● F1113012-300.A	431,00 €
● F1113018-300.A	431,00 €
● F1113030-300.A	431,00 €
● F1113033-300.A	431,00 €

4000K

Non Dimmable

○ F1115001.A	333,00 €
● F1115006.A	333,00 €
● F1115012.A	333,00 €
● F1115018.A	333,00 €
● F1115030.A	333,00 €
● F1115033.A	333,00 €
1-10V	
○ F1115001-310.A	431,00 €
● F1115006-310.A	431,00 €
● F1115012-310.A	431,00 €
● F1115018-310.A	431,00 €
● F1115030-310.A	431,00 €
● F1115033-310.A	431,00 €
Dali	
○ F1115001-300.A	431,00 €
● F1115006-300.A	431,00 €
● F1115012-300.A	431,00 €
● F1115018-300.A	431,00 €
● F1115030-300.A	431,00 €
● F1115033-300.A	431,00 €

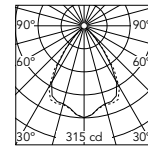

Beam Angle: 70°

h(m)	Et(x)	D(m)
1	315	1.42
2	79	2.85
3	35	4.27
4	20	5.70
5	13	7.12

@4000K

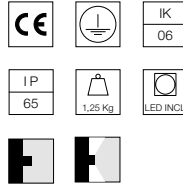
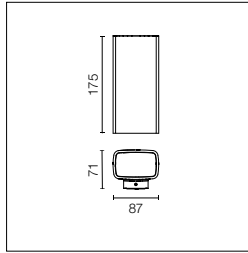

Alimentation 110/240V intégrée.
Pré-câblé avec câble sortant en néoprène de 80 mm.

Integrated 110/240V power supply. Supplied with an 80 mm length outgoing neoprene cable.

2200K disponible sur demande.

2200K available on request.

Power Led: 12W - 2x432 lm ≠ *FIXT 2x392 lm - 2700K/CRI 80 - 110-240V / 12W - 2x468 lm ≠ *FIXT 2x425 lm - 3000K/CRI 80 - 110-240V / 12W - 2x504 lm ≠ *FIXT 2x458 lm - 4000K/CRI 80 - 110-240V / *FIXT lm = Spot Optic

Optic Spot

2700K		3000K		4000K	
Non Dimmable					
○ F1116001.A	370,00 €	○ F1118001.A	370,00 €	○ F1120001.A	370,00 €
● F1116006.A	370,00 €	● F1118006.A	370,00 €	● F1120006.A	370,00 €
● F1116012.A	370,00 €	● F1118012.A	370,00 €	● F1120012.A	370,00 €
● F1116018.A	370,00 €	● F1118018.A	370,00 €	● F1120018.A	370,00 €
● F1116030.A	370,00 €	● F1118030.A	370,00 €	● F1120030.A	370,00 €
● F1116033.A	370,00 €	● F1118033.A	370,00 €	● F1120033.A	370,00 €
1-10V					
○ F1116001-310.A	485,00 €	○ F1118001-310.A	485,00 €	○ F1120001-310.A	485,00 €
● F1116006-310.A	485,00 €	● F1118006-310.A	485,00 €	● F1120006-310.A	485,00 €
● F1116012-310.A	485,00 €	● F1118012-310.A	485,00 €	● F1120012-310.A	485,00 €
● F1116018-310.A	485,00 €	● F1118018-310.A	485,00 €	● F1120018-310.A	485,00 €
● F1116030-310.A	485,00 €	● F1118030-310.A	485,00 €	● F1120030-310.A	485,00 €
● F1116033-310.A	485,00 €	● F1118033-310.A	485,00 €	● F1120033-310.A	485,00 €
Dali					
○ F1116001-300.A	485,00 €	○ F1118001-300.A	485,00 €	○ F1120001-300.A	485,00 €
● F1116006-300.A	485,00 €	● F1118006-300.A	485,00 €	● F1120006-300.A	485,00 €
● F1116012-300.A	485,00 €	● F1118012-300.A	485,00 €	● F1120012-300.A	485,00 €
● F1116018-300.A	485,00 €	● F1118018-300.A	485,00 €	● F1120018-300.A	485,00 €
● F1116030-300.A	485,00 €	● F1118030-300.A	485,00 €	● F1120030-300.A	485,00 €
● F1116033-300.A	485,00 €	● F1118033-300.A	485,00 €	● F1120033-300.A	485,00 €

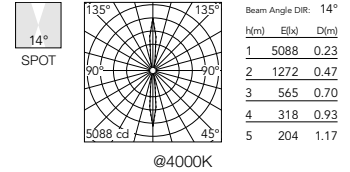

Optic Flood

2700K		3000K		4000K	
Non Dimmable					
○ F1117001.A	370,00 €	○ F1119001.A	370,00 €	○ F1121001.A	370,00 €
● F1117006.A	370,00 €	● F1119006.A	370,00 €	● F1121006.A	370,00 €
● F1117012.A	370,00 €	● F1119012.A	370,00 €	● F1121012.A	370,00 €
● F1117018.A	370,00 €	● F1119018.A	370,00 €	● F1121018.A	370,00 €
● F1117030.A	370,00 €	● F1119030.A	370,00 €	● F1121030.A	370,00 €
● F1117033.A	370,00 €	● F1119033.A	370,00 €	● F1121033.A	370,00 €
1-10V					
○ F1117001-310.A	485,00 €	○ F1119001-310.A	485,00 €	○ F1121001-310.A	485,00 €
● F1117006-310.A	485,00 €	● F1119006-310.A	485,00 €	● F1121006-310.A	485,00 €
● F1117012-310.A	485,00 €	● F1119012-310.A	485,00 €	● F1121012-310.A	485,00 €
● F1117018-310.A	485,00 €	● F1119018-310.A	485,00 €	● F1121018-310.A	485,00 €
● F1117030-310.A	485,00 €	● F1119030-310.A	485,00 €	● F1121030-310.A	485,00 €
● F1117033-310.A	485,00 €	● F1119033-310.A	485,00 €	● F1121033-310.A	485,00 €
Dali					
○ F1117001-300.A	485,00 €	○ F1119001-300.A	485,00 €	○ F1121001-300.A	485,00 €
● F1117006-300.A	485,00 €	● F1119006-300.A	485,00 €	● F1121006-300.A	485,00 €
● F1117012-300.A	485,00 €	● F1119012-300.A	485,00 €	● F1121012-300.A	485,00 €
● F1117018-300.A	485,00 €	● F1119018-300.A	485,00 €	● F1121018-300.A	485,00 €
● F1117030-300.A	485,00 €	● F1119030-300.A	485,00 €	● F1121030-300.A	485,00 €
● F1117033-300.A	485,00 €	● F1119033-300.A	485,00 €	● F1121033-300.A	485,00 €

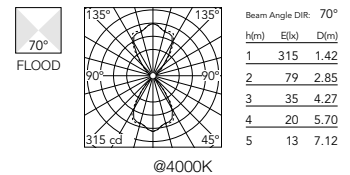

Climber 87: Accessoires / Accessories

<p>Dispositif de protection contre les surtensions. 275Vac. Courant de décharge maximal 10KA (8/20µs). Courant de fonctionnement maximal 5A. Adapté pour les connexions en séries. IP66.</p>	<p>Surge protection device. 275Vac. Maximum discharge current 10KA (8/20µs). Maximum operating current 5A. Suitable for series connection. IP66.</p>	<p>F990E00A000</p>	<p>116,00 €</p>		
<p>Gelbox IPX8 pour le raccordement électrique.</p>	<p>Gelbox IPX8 for splicing connectors.</p>	<p>F990C100000</p>	<p>14,00 €</p>		
<p>Gelbox IPX8 pour le raccordement électrique.</p>	<p>Gelbox IPX8 for splicing connectors.</p>	<p>F990C110000</p>	<p>22,00 €</p>		
<p>Système de jonction IP68 H2O Stop anti-condensation à 2 voies 4 pôles.</p>	<p>2 way terminal block 4 poles IP68 H2O Stop.</p>	<p>F990C00A000</p>	<p>33,00 €</p>		
<p>Système de jonction IP68 H2O Stop anti-condensation à 3/4 voies 4 pôles. (Ø5,5÷12mm câble).</p>	<p>3/4 way terminal block 4 poles IP68 H2O Stop. (ø5,5÷12mm cable).</p>	<p>F990C010000</p>	<p>60,00 €</p>		
<p>Kit de connecteurs à 5 pôles: fiche volante + fiche EU IP68.</p>	<p>Connector kit 5-pole flying socket + EU plug IP68.</p>	<p>F990C080000</p>	<p>48,00 €</p>		
<p>Boitier de dérivation 5 pôles 4 voies (câbles 6-14 mm).</p>	<p>4 way junction box 5 poles IP68 (6-14 mm cables).</p>	<p>F990C030000</p>	<p>62,00 €</p>		



Climber 175 Down

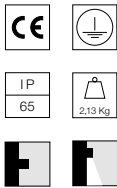
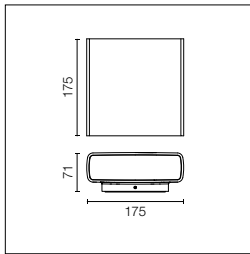

Alimentation 110/240V intégrée.
Pré-câblé avec câble sortant en néoprène de 80 mm.
Version à émission simple vers le haut. Disponible sur demande.

Integrated 110/240V power supply.
Supplied with an 80 mm length outgoing neoprene cable.
Upwards, single emission version, available upon request.

2200K disponible sur demande.

2200K available on request.

Power Led: 12W - 864 lm ≠ *FIXT 721 lm - 2700K/CRI 80 - 110-240V / 12W - 936 lm ≠ *FIXT 781 lm - 3000K/CRI 80 - 110-240V / 12W - 1008 lm ≠ *FIXT 841 lm - 4000K/CRI 80 - 110-240V / *FIXT lm = Spot Optic

Optic Spot

2700K

Non Dimmable	
○ F1140001	478,00 €
● F1140006	478,00 €
● F1140012	478,00 €
● F1140018	478,00 €
● F1140030	478,00 €
● F1140033	478,00 €
1-10V	
○ F1140001-310.A	554,00 €
● F1140006-310.A	554,00 €
● F1140012-310.A	554,00 €
● F1140018-310.A	554,00 €
● F1140030-310.A	554,00 €
● F1140033-310.A	554,00 €
DALI	
○ F1140001-300.B	554,00 €
● F1140006-300.B	554,00 €
● F1140012-300.B	554,00 €
● F1140018-300.B	554,00 €
● F1140030-300.B	554,00 €
● F1140033-300.B	554,00 €

3000K

Non Dimmable	
○ F1142001	478,00 €
● F1142006	478,00 €
● F1142012	478,00 €
● F1142018	478,00 €
● F1142030	478,00 €
● F1142033	478,00 €
1-10V	
○ F1142001-310.A	554,00 €
● F1142006-310.A	554,00 €
● F1142012-310.A	554,00 €
● F1142018-310.A	554,00 €
● F1142030-310.A	554,00 €
● F1142033-310.A	554,00 €
DALI	
○ F1142001-300.B	554,00 €
● F1142006-300.B	554,00 €
● F1142012-300.B	554,00 €
● F1142018-300.B	554,00 €
● F1142030-300.B	554,00 €
● F1142033-300.B	554,00 €

4000K

Non Dimmable	
○ F1144001	478,00 €
● F1144006	478,00 €
● F1144012	478,00 €
● F1144018	478,00 €
● F1144030	478,00 €
● F1144033	478,00 €
1-10V	
○ F1144001-310.A	554,00 €
● F1144006-310.A	554,00 €
● F1144012-310.A	554,00 €
● F1144018-310.A	554,00 €
● F1144030-310.A	554,00 €
● F1144033-310.A	554,00 €
DALI	
○ F1144001-300.B	554,00 €
● F1144006-300.B	554,00 €
● F1144012-300.B	554,00 €
● F1144018-300.B	554,00 €
● F1144030-300.B	554,00 €
● F1144033-300.B	554,00 €

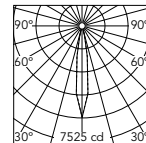

Beam Angle: 14°			
h(m)	Et(x)	D(m)	
1	7525	0.28	
2	1881	0.55	
3	836	0.83	
4	470	1.10	
5	301	1.38	

@4000K

Optic Flood

2700K

Non Dimmable	
○ F1141001	478,00 €
● F1141006	478,00 €
● F1141012	478,00 €
● F1141018	478,00 €
● F1141030	478,00 €
● F1141033	478,00 €
1-10V	
○ F1141001-310.A	554,00 €
● F1141006-310.A	554,00 €
● F1141012-310.A	554,00 €
● F1141018-310.A	554,00 €
● F1141030-310.A	554,00 €
● F1141033-310.A	554,00 €
DALI	
○ F1141001-300.B	554,00 €
● F1141006-300.B	554,00 €
● F1141012-300.B	554,00 €
● F1141018-300.B	554,00 €
● F1141030-300.B	554,00 €
● F1141033-300.B	554,00 €

3000K

Non Dimmable	
○ F1143001	478,00 €
● F1143006	478,00 €
● F1143012	478,00 €
● F1143018	478,00 €
● F1143030	478,00 €
● F1143033	478,00 €
1-10V	
○ F1143001-310.A	554,00 €
● F1143006-310.A	554,00 €
● F1143012-310.A	554,00 €
● F1143018-310.A	554,00 €
● F1143030-310.A	554,00 €
● F1143033-310.A	554,00 €
DALI	
○ F1143001-300.B	554,00 €
● F1143006-300.B	554,00 €
● F1143012-300.B	554,00 €
● F1143018-300.B	554,00 €
● F1143030-300.B	554,00 €
● F1143033-300.B	554,00 €

4000K

Non Dimmable	
○ F1145001	478,00 €
● F1145006	478,00 €
● F1145012	478,00 €
● F1145018	478,00 €
● F1145030	478,00 €
● F1145033	478,00 €
1-10V	
○ F1145001-310	554,00 €
● F1145006-310	554,00 €
● F1145012-310	554,00 €
● F1145018-310	554,00 €
● F1145030-310	554,00 €
● F1145033-310	554,00 €
DALI	
○ F1145001-300.A	554,00 €
● F1145006-300.A	554,00 €
● F1145012-300.A	554,00 €
● F1145018-300.A	554,00 €
● F1145030-300.A	554,00 €
● F1145033-300.A	554,00 €

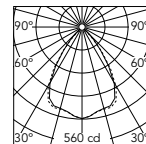

Beam Angle: 70°			
h(m)	Et(x)	D(m)	
1	560	1.41	
2	140	2.83	
3	62	4.24	
4	35	5.65	
5	22	7.06	

@4000K

Climber 175 Up&Down

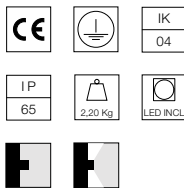
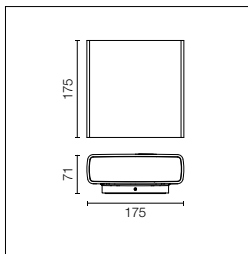

Alimentation 220/240V intégrée.
Pré-câblé avec câble sortant en néoprène de 80 mm.

Integrated 220/240V power supply. Supplied with an 80 mm length outgoing neoprene cable.

2200K disponible sur demande.

2200K available on request.

Power Led: 21W - 2x864 lm ≠ *FIXT 2x739 lm - 2700K/CRI 80 - 220-240V / 21W - 2x936 lm ≠ *FIXT 2x800 lm - 3000K/CRI 80 - 220-240V / 21W - 2x1008 lm ≠ *FIXT 2x862 lm - 4000K/CRI 80 - 220-240V / *FIXT lm = Spot Optic

Optic Spot

2700K		3000K		4000K	
Non Dimmable		Non Dimmable		Non Dimmable	
○ F1146001	541,00 €	○ F1148001	541,00 €	○ F1150001	541,00 €
● F1146006	541,00 €	● F1148006	541,00 €	● F1150006	541,00 €
● F1146012	541,00 €	● F1148012	541,00 €	● F1150012	541,00 €
● F1146018	541,00 €	● F1148018	541,00 €	● F1150018	541,00 €
● F1146030	541,00 €	● F1148030	541,00 €	● F1150030	541,00 €
● F1146033	541,00 €	● F1148033	541,00 €	● F1150033	541,00 €
1-10V		1-10V		1-10V	
○ F1146001-310.A	615,00 €	○ F1148001-310.A	615,00 €	○ F1150001-310.A	615,00 €
● F1146006-310.A	615,00 €	● F1148006-310.A	615,00 €	● F1150006-310.A	615,00 €
● F1146012-310.A	615,00 €	● F1148012-310.A	615,00 €	● F1150012-310.A	615,00 €
● F1146018-310.A	615,00 €	● F1148018-310.A	615,00 €	● F1150018-310.A	615,00 €
● F1146030-310.A	615,00 €	● F1148030-310.A	615,00 €	● F1150030-310.A	615,00 €
● F1146033-310.A	615,00 €	● F1148033-310.A	615,00 €	● F1150033-310.A	615,00 €
Dali		Dali		Dali	
○ F1146001-300.B	615,00 €	○ F1148001-300.B	615,00 €	○ F1150001-300.B	615,00 €
● F1146006-300.B	615,00 €	● F1148006-300.B	615,00 €	● F1150006-300.B	615,00 €
● F1146012-300.B	615,00 €	● F1148012-300.B	615,00 €	● F1150012-300.B	615,00 €
● F1146018-300.B	615,00 €	● F1148018-300.B	615,00 €	● F1150018-300.B	615,00 €
● F1146030-300.B	615,00 €	● F1148030-300.B	615,00 €	● F1150030-300.B	615,00 €
● F1146033-300.B	615,00 €	● F1148033-300.B	615,00 €	● F1150033-300.B	615,00 €

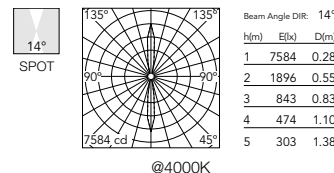

Optic Flood

2700K		3000K		4000K	
Non Dimmable		Non Dimmable		Non Dimmable	
○ F1147001	541,00 €	○ F1149001	541,00 €	○ F1151001	541,00 €
● F1147006	541,00 €	● F1149006	541,00 €	● F1151006	541,00 €
● F1147012	541,00 €	● F1149012	541,00 €	● F1151012	541,00 €
● F1147018	541,00 €	● F1149018	541,00 €	● F1151018	541,00 €
● F1147030	541,00 €	● F1149030	541,00 €	● F1151030	541,00 €
● F1147033	541,00 €	● F1149033	541,00 €	● F1151033	541,00 €
1-10V		1-10V		1-10V	
○ F1147001-310.A	615,00 €	○ F1149001-310.A	615,00 €	○ F1151001-310.A	615,00 €
● F1147006-310.A	615,00 €	● F1149006-310.A	615,00 €	● F1151006-310.A	615,00 €
● F1147012-310.A	615,00 €	● F1149012-310.A	615,00 €	● F1151012-310.A	615,00 €
● F1147018-310.A	615,00 €	● F1149018-310.A	615,00 €	● F1151018-310.A	615,00 €
● F1147030-310.A	615,00 €	● F1149030-310.A	615,00 €	● F1151030-310.A	615,00 €
● F1147033-310.A	615,00 €	● F1149033-310.A	615,00 €	● F1151033-310.A	615,00 €
Dali		Dali		Dali	
○ F1147001-300.B	615,00 €	○ F1149001-300.B	615,00 €	○ F1151001-300.B	615,00 €
● F1147006-300.B	615,00 €	● F1149006-300.B	615,00 €	● F1151006-300.B	615,00 €
● F1147012-300.B	615,00 €	● F1149012-300.B	615,00 €	● F1151012-300.B	615,00 €
● F1147018-300.B	615,00 €	● F1149018-300.B	615,00 €	● F1151018-300.B	615,00 €
● F1147030-300.B	615,00 €	● F1149030-300.B	615,00 €	● F1151030-300.B	615,00 €
● F1147033-300.B	615,00 €	● F1149033-300.B	615,00 €	● F1151033-300.B	615,00 €

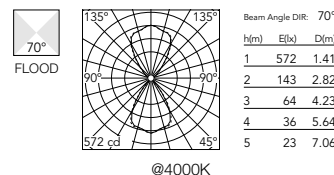

Climber 175: Accessoires / Accessories

Dispositif de protection contre les surtensions. 275Vac. Courant de décharge maximal 10KA (8/20µs). Adapté pour les connexions en séries. IP66.

Surge protection device. 275Vac. Maximum discharge current 10KA (8/20µs). Maximum operating current 5A. Suitable for series connection. IP66.

F990E00A000 116,00 €

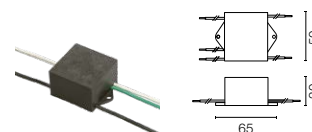

Climber 275 Down

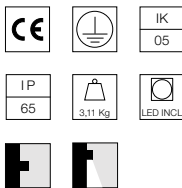
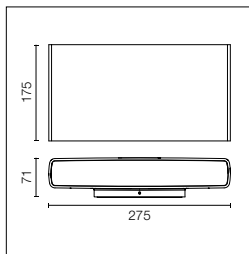

Alimentation 110/240V intégrée.
Pré-câblé avec câble sortant en néoprène de 80 mm.
Version à émission simple vers le haut. Disponible sur demande.

Integrated 110/240V power supply.
Supplied with an 80 mm length outgoing neoprene cable.
Upwards, single emission version, available upon request.

2200K disponible sur demande.

2200K available on request.

Power Led: 21W - 1728 lm ≠ *FIXT 1240 lm - 2700K/CRI 80 - 220-240V / 21W - 1872 lm ≠ *FIXT 1344 lm - 3000K/CRI 80 - 220-240V /

21W - 2016 lm ≠ *FIXT 1447 lm - 4000K/CRI 80 - 220-240V

*FIXT lm = Spot Optic

Optic Spot

2700K

Non Dimmable

○ F1170001	712,00 €
● F1170006	712,00 €
● F1170012	712,00 €
● F1170018	712,00 €
● F1170030	712,00 €
● F1170033	712,00 €

1-10V

○ F1170001-310.A	808,00 €
● F1170006-310.A	808,00 €
● F1170012-310.A	808,00 €
● F1170018-310.A	808,00 €
● F1170030-310.A	808,00 €
● F1170033-310.A	808,00 €

DALI

○ F1170001-300.A	828,00 €
● F1170006-300.A	828,00 €
● F1170012-300.A	828,00 €
● F1170018-300.A	828,00 €
● F1170030-300.A	828,00 €
● F1170033-300.A	828,00 €

3000K

Non Dimmable

○ F1172001	712,00 €
● F1172006	712,00 €
● F1172012	712,00 €
● F1172018	712,00 €
● F1172030	712,00 €
● F1172033	712,00 €

1-10V

○ F1172001-310.A	808,00 €
● F1172006-310.A	808,00 €
● F1172012-310.A	808,00 €
● F1172018-310.A	808,00 €
● F1172030-310.A	808,00 €
● F1172033-310.A	808,00 €

DALI

○ F1172001-300.A	828,00 €
● F1172006-300.A	828,00 €
● F1172012-300.A	828,00 €
● F1172018-300.A	828,00 €
● F1172030-300.A	828,00 €
● F1172033-300.A	828,00 €

4000K

Non Dimmable

○ F1174001	712,00 €
● F1174006	712,00 €
● F1174012	712,00 €
● F1174018	712,00 €
● F1174030	712,00 €
● F1174033	712,00 €

1-10V

○ F1174001-310.A	808,00 €
● F1174006-310.A	808,00 €
● F1174012-310.A	808,00 €
● F1174018-310.A	808,00 €
● F1174030-310.A	808,00 €
● F1174033-310.A	808,00 €

DALI

○ F1174001-300.A	828,00 €
● F1174006-300.A	828,00 €
● F1174012-300.A	828,00 €
● F1174018-300.A	828,00 €
● F1174030-300.A	828,00 €
● F1174033-300.A	828,00 €

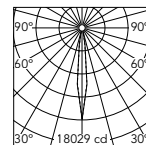

Beam Angle: 14°

h(m)	Et(x)	D(m)
1	18029	0.22
2	4507	0.44
3	2003	0.66
4	1127	0.87
5	721	1.09

@4000K

Optic Flood

2700K

Non Dimmable

○ F1171001	712,00 €
● F1171006	712,00 €
● F1171012	712,00 €
● F1171018	712,00 €
● F1171030	712,00 €
● F1171033	712,00 €

1-10V

○ F1171001-310.A	808,00 €
● F1171006-310.A	808,00 €
● F1171012-310.A	808,00 €
● F1171018-310.A	808,00 €
● F1171030-310.A	808,00 €
● F1171033-310.A	808,00 €

DALI

○ F1171001-300.A	828,00 €
● F1171006-300.A	828,00 €
● F1171012-300.A	828,00 €
● F1171018-300.A	828,00 €
● F1171030-300.A	828,00 €
● F1171033-300.A	828,00 €

3000K

Non Dimmable

○ F1173001	712,00 €
● F1173006	712,00 €
● F1173012	712,00 €
● F1173018	712,00 €
● F1173030	712,00 €
● F1173033	712,00 €

1-10V

○ F1173001-310.A	808,00 €
● F1173006-310.A	808,00 €
● F1173012-310.A	808,00 €
● F1173018-310.A	808,00 €
● F1173030-310.A	808,00 €
● F1173033-310.A	808,00 €

DALI

○ F1173001-300.A	828,00 €
● F1173006-300.A	828,00 €
● F1173012-300.A	828,00 €
● F1173018-300.A	828,00 €
● F1173030-300.A	828,00 €
● F1173033-300.A	828,00 €

4000K

Non Dimmable

○ F1175001	712,00 €
● F1175006	712,00 €
● F1175012	712,00 €
● F1175018	712,00 €
● F1175030	712,00 €
● F1175033	712,00 €

1-10V

○ F1175001-310.A	808,00 €
● F1175006-310.A	808,00 €
● F1175012-310.A	808,00 €
● F1175018-310.A	808,00 €
● F1175030-310.A	808,00 €
● F1175033-310.A	808,00 €

DALI

○ F1175001-300.A	828,00 €
● F1175006-300.A	828,00 €
● F1175012-300.A	828,00 €
● F1175018-300.A	828,00 €
● F1175030-300.A	828,00 €
● F1175033-300.A	828,00 €

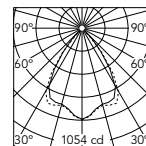

Beam Angle: 70°

h(m)	Et(x)	D(m)
1	1054	1.45
2	263	2.89
3	117	4.34
4	66	5.78
5	42	7.23

@4000K

Climber 275 Up&Down

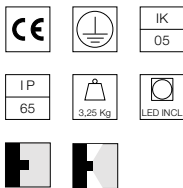
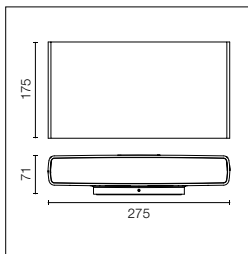

Alimentation 220/240V intégrée.
Pré-câblé avec câble sortant en néoprène de 80 mm.

Integrated 220/240V power supply. Supplied with an 80 mm length outgoing neoprene cable.

2200K disponible sur demande.

2200K available on request.

Power Led: 40W - 2x1728 lm ≠ *FIXT 2x1264 lm - 2700K/CRI 80 - 220-240V / 40W - 2x1872 lm ≠ *FIXT 2x1370 lm - 3000K/CRI 80 - 220-240V / 40W - 2x2016 lm ≠ *FIXT 2x1475 lm - 4000K/CRI 80 - 220-240V
*FIXT lm = Spot Optic

Optic Spot

2700K		3000K		4000K	
Non Dimmable					
○ F1176001	834,00 €	○ F1178001	834,00 €	○ F1180001	834,00 €
● F1176006	834,00 €	● F1178006	834,00 €	● F1180006	834,00 €
● F1176012	834,00 €	● F1178012	834,00 €	● F1180012	834,00 €
● F1176018	834,00 €	● F1178018	834,00 €	● F1180018	834,00 €
● F1176030	834,00 €	● F1178030	834,00 €	● F1180030	834,00 €
● F1176033	834,00 €	● F1178033	834,00 €	● F1180033	834,00 €
1-10V					
○ F1176001-310.A	932,00 €	○ F1178001-310.A	932,00 €	○ F1180001-310.A	932,00 €
● F1176006-310.A	932,00 €	● F1178006-310.A	932,00 €	● F1180006-310.A	932,00 €
● F1176012-310.A	932,00 €	● F1178012-310.A	932,00 €	● F1180012-310.A	932,00 €
● F1176018-310.A	932,00 €	● F1178018-310.A	932,00 €	● F1180018-310.A	932,00 €
● F1176030-310.A	932,00 €	● F1178030-310.A	932,00 €	● F1180030-310.A	932,00 €
● F1176033-310.A	932,00 €	● F1178033-310.A	932,00 €	● F1180033-310.A	932,00 €
Dali					
○ F1176001-300.A	950,00 €	○ F1178001-300.A	950,00 €	○ F1180001-300.A	950,00 €
● F1176006-300.A	950,00 €	● F1178006-300.A	950,00 €	● F1180006-300.A	950,00 €
● F1176012-300.A	950,00 €	● F1178012-300.A	950,00 €	● F1180012-300.A	950,00 €
● F1176018-300.A	950,00 €	● F1178018-300.A	950,00 €	● F1180018-300.A	950,00 €
● F1176030-300.A	950,00 €	● F1178030-300.A	950,00 €	● F1180030-300.A	950,00 €
● F1176033-300.A	950,00 €	● F1178033-300.A	950,00 €	● F1180033-300.A	950,00 €

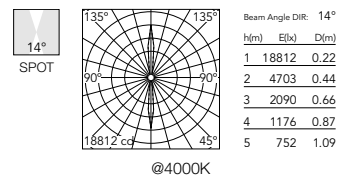

Optic Flood

2700K		3000K		4000K	
Non Dimmable					
○ F1177001	834,00 €	○ F1179001	834,00 €	○ F1181001	834,00 €
● F1177006	834,00 €	● F1179006	834,00 €	● F1181006	834,00 €
● F1177012	834,00 €	● F1179012	834,00 €	● F1181012	834,00 €
● F1177018	834,00 €	● F1179018	834,00 €	● F1181018	834,00 €
● F1177030	834,00 €	● F1179030	834,00 €	● F1181030	834,00 €
● F1177033	834,00 €	● F1179033	834,00 €	● F1181033	834,00 €
1-10V					
○ F1177001-310.A	932,00 €	○ F1179001-310.A	932,00 €	○ F1181001-310.A	932,00 €
● F1177006-310.A	932,00 €	● F1179006-310.A	932,00 €	● F1181006-310.A	932,00 €
● F1177012-310.A	932,00 €	● F1179012-310.A	932,00 €	● F1181012-310.A	932,00 €
● F1177018-310.A	932,00 €	● F1179018-310.A	932,00 €	● F1181018-310.A	932,00 €
● F1177030-310.A	932,00 €	● F1179030-310.A	932,00 €	● F1181030-310.A	932,00 €
● F1177033-310.A	932,00 €	● F1179033-310.A	932,00 €	● F1181033-310.A	932,00 €
Dali					
○ F1177001-300.A	950,00 €	○ F1179001-300.A	950,00 €	○ F1181001-300.A	950,00 €
● F1177006-300.A	950,00 €	● F1179006-300.A	950,00 €	● F1181006-300.A	950,00 €
● F1177012-300.A	950,00 €	● F1179012-300.A	950,00 €	● F1181012-300.A	950,00 €
● F1177018-300.A	950,00 €	● F1179018-300.A	950,00 €	● F1181018-300.A	950,00 €
● F1177030-300.A	950,00 €	● F1179030-300.A	950,00 €	● F1181030-300.A	950,00 €
● F1177033-300.A	950,00 €	● F1179033-300.A	950,00 €	● F1181033-300.A	950,00 €

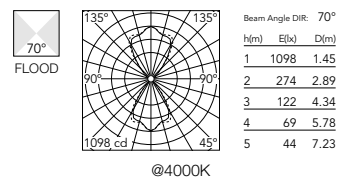

Climber 275: Accessoires / Accessories

Dispositif de protection contre les surtensions. 275Vac. Courant de décharge maximal 10KA (8/20µs). Adapté pour les connexions en séries. IP66.

Surge protection device. 275Vac. Maximum discharge current 10KA (8/20µs). Maximum operating current 5A. Suitable for series connection. IP66.

F990E00A000 116,00 €

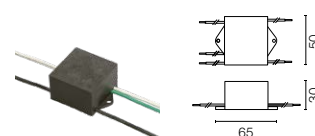

Heavy Metal





Heavy Metal Spot



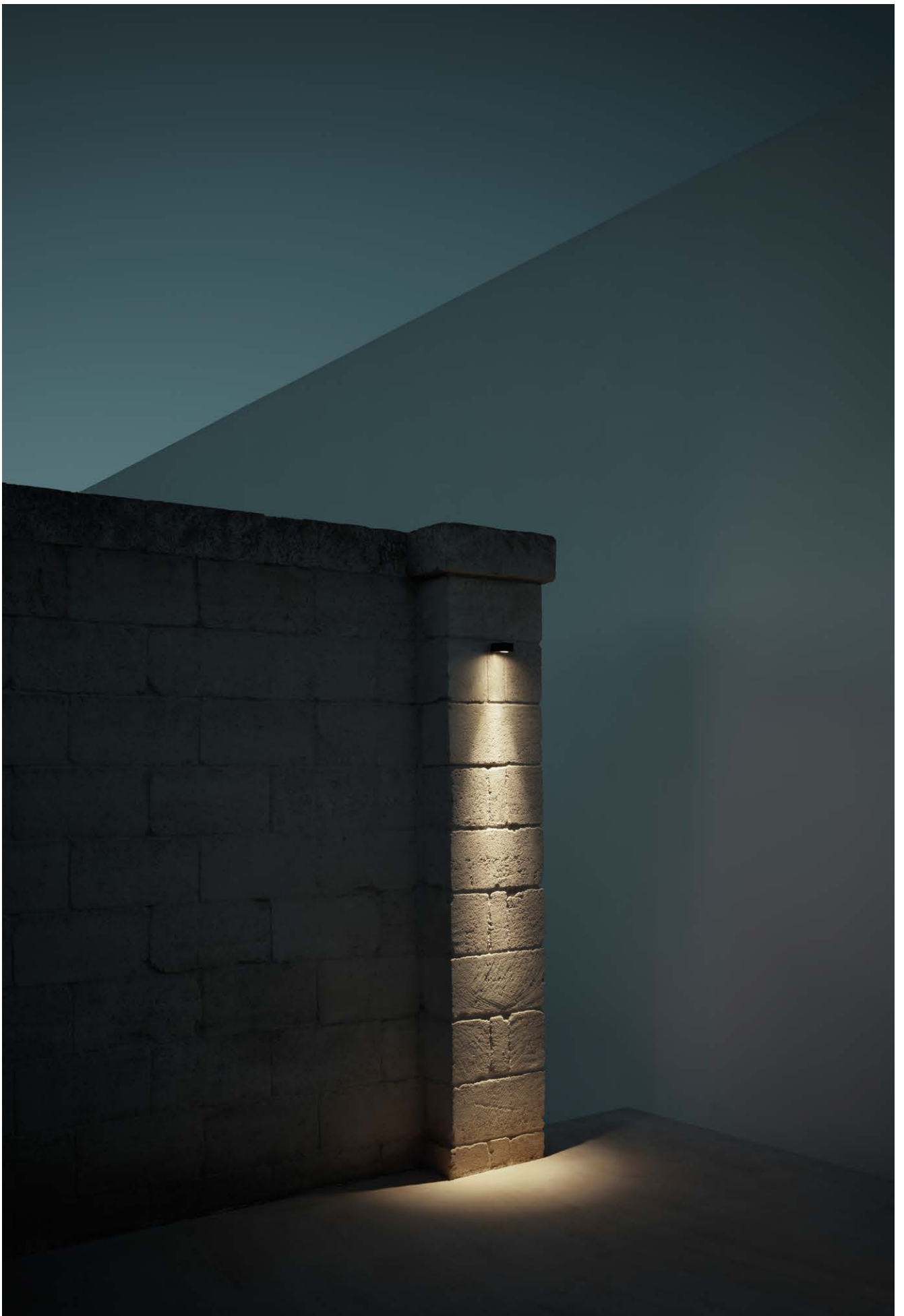

Heavy Metal Wall 1

Famille / Family

Heavy Metal Spot 1



Power Led

up to 3,4W
up to 138 lm - 2700K/CRI 80
up to 149 lm - 3000K/CRI 80
up to 155 lm - 4000K/CRI 80
* Net lumen output
2200K available on request.

Power Led

up to 4,5W
up to 246 lm - 2700K/CRI 80
up to 267 lm - 3000K/CRI 80
up to 277 lm - 4000K/CRI 80
* Net lumen output
2200K available on request.

Heavy Metal Spot 2

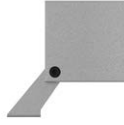

Power Led

up to 5,9W
up to 364 lm - 2700K/CRI 80
up to 395 lm - 3000K/CRI 80
up to 410 lm - 4000K/CRI 80
* Net lumen output
2200K available on request.

Heavy Metal Wall 1



Power Led

up to 3,4W
up to 138 lm - 2700K/CRI 80
up to 149 lm - 3000K/CRI 80
up to 155 lm - 4000K/CRI 80
* Net lumen output
2200K available on request.

Power Led

up to 4,5W
up to 246 lm - 2700K/CRI 80
up to 267 lm - 3000K/CRI 80
up to 277 lm - 4000K/CRI 80
* Net lumen output
2200K available on request.

Heavy Metal Wall 2 Mono / Double



Power Led

up to 3,4W
up to 138 lm - 2700K/CRI 80
up to 149 lm - 3000K/CRI 80
up to 155 lm - 4000K/CRI 80
* Net lumen output
2200K available on request.

Power Led

up to 4,5W
up to 246 lm - 2700K/CRI 80
up to 267 lm - 3000K/CRI 80
up to 277 lm - 4000K/CRI 80
* Net lumen output
2200K available on request.

Power Led

up to 6,8W
up to 2x138 lm - 2700K/CRI 80
up to 2x149 lm - 3000K/CRI 80
up to 2x155 lm - 4000K/CRI 80
* Net lumen output
2200K available on request.

Power Led

up to 9W
up to 2x246 lm - 2700K/CRI 80
up to 2x267 lm - 3000K/CRI 80
up to 2x277 lm - 4000K/CRI 80
* Net lumen output
2200K available on request.

Heavy Metal Wall 3 Mono / Double



Mid-Power Led

up to 2,5W
up to 125 lm - 2700K/CRI 80
up to 134 lm - 3000K/CRI 80
up to 142 lm - 4000K/CRI 80
* Net lumen output
2200K available on request.

Mid-Power Led

up to 5W
up to 2x125 lm - 2700K/CRI 80
up to 2x134 lm - 3000K/CRI 80
up to 2x142 lm - 4000K/CRI 80
* Net lumen output
2200K available on request.

Finitions / Colours



01 White

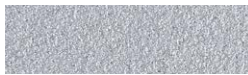

06 Grey

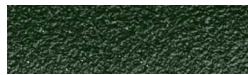

12 Forest Green



18 Deep Brown



30 Black



33 Anthracite

Famille complète de luminaires avec source LED, disponibles en différentes finitions avec un revêtement à poudre double couche et une surface traitée par procédé de conversion chimique pour garantir une haute résistance à la corrosion. Les vis de fixation sont en acier inoxydable AISI 316L.

Heavy Metal Spot

Projecteur ultra-compact et ajustable, conçu pour être installé au plafond, au mur ou au sol, avec borne à commander séparément. Disponible en deux tailles (50x50 mm et 70x70 mm) et avec différentes ouvertures du faisceau lumineux pour répondre aux différentes exigences lumineuses. Structure en aluminium usiné par tournage, alliage EN AW 6060, et équerre de fixation en acier inoxydable AISI 316L finie dans les mêmes tons que le luminaire pour un résultat d'ensemble parfait. L'équerre de maintien permet une orientation de 180° sur l'axe vertical et une orientation inférieure de 20° sur l'axe horizontale, pour diriger le faisceau lumineux en fonction des exigences. Diffuseur en verre extra-clair avec un bord sérigraphié, fixé par un système d'encollage robotisé. Luminaire en 24V dc, nécessite une source d'alimentation à distance à commander séparément.

Heavy Metal Wall 1

Luminaire mural. Disponible avec émission lumineuse monodirectionnelle ou bidirectionnelle et avec différentes ouvertures du faisceau lumineux pour répondre aux différentes exigences lumineuses. Structure en aluminium usiné par tournage, alliage EN AW 6060. Plaque d'ancrage au mur en acier inoxydable AISI 316L. Diffuseur en verre extra-clair avec un bord sérigraphié, fixé par un système d'encollage robotisé. Luminaire en 24V dc, nécessite une source d'alimentation à distance à commander séparément.

Heavy Metal Wall 2

Luminaire mural. Disponible avec émission lumineuse monodirectionnelle ou bidirectionnelle et avec différentes ouvertures du faisceau lumineux pour répondre aux différentes exigences lumineuses. Structure en aluminium usiné par tournage, alliage EN AW 6060. Plaque d'ancrage au mur en acier inoxydable AISI 316L. Diffuseur en verre extra-clair avec un bord sérigraphié, fixé par un système d'encollage robotisé. Luminaire en 24V dc, nécessite une source d'alimentation à distance à commander séparément.

Heavy Metal Wall 3

Luminaire mural. Disponible avec émission lumineuse monodirectionnelle ou bidirectionnelle avec une ouverture du faisceau lumineux douce et diffuse. Structure en aluminium usiné par tournage, alliage EN AW 6060. Plaque d'ancrage au mur en acier inoxydable AISI 316L. Diffuseur en verre dépoli avec un bord sérigraphié, fixé par un système d'encollage robotisé. Luminaire en 24V dc, nécessite une source d'alimentation à distance à commander séparément. Pour faciliter l'installation, une boîte de dérivation est disponible avec 3 modules, modèle 503, où une seule source d'alimentation IP65 peut être placée.

Complete family of luminaires with LED light source, available in different finishes with a double layer coating and a chemical conversion surface treatment to guarantee high resistance to corrosion. The fixing screws are made of AISI 316L stainless steel.

Heavy Metal Spot

Ultra-compact, adjustable projector, designed for ground, wall or ceiling installation, and a post to be ordered separately. Available in two sizes (50x50 mm and 70x70 mm) and with different beam angles to meet different lighting requirements. Turned aluminium structure, EN AW 6060 alloy and AISI 316L stainless steel fixing bracket matching the luminaire finishes for a perfect overall look. The fixing bracket allows an orientation of 180° on the vertical axis and an orientation of less than 20° on the horizontal axis in order to direct the light beam according to requirements. Extra clear glass diffuser with silkscreen border, fixed through a robotic gluing system 24V dc luminaire powered by a remote power supply to be ordered separately.

Heavy Metal Wall 1

Wall luminaire. Available with monodirectional or bidirectional light emission and with different beam angles to meet different lighting requirements. Turned aluminium body, EN AW 6060 alloy. Stainless steel AISI 316L wall fixing plate. Extra clear glass diffuser with silkscreen border, fixed through a robotic gluing system. 24V dc luminaire powered by a remote power supply to be ordered separately.

Heavy Metal Wall 2

Wall luminaire. Available with monodirectional or bidirectional light emission and with different beam angles to meet different lighting requirements. Turned aluminium body, EN AW 6060 alloy. Stainless steel AISI 316L wall fixing plate. Extra clear glass diffuser with silkscreen border, fixed through a robotic gluing system. 24V dc luminaire powered by a remote power supply to be ordered separately.

Heavy Metal Wall 3

Wall luminaire. Available with monodirectional or bidirectional light emission and a smooth and diffuse beam angle. Turned aluminium body, EN AW 6060 alloy. Stainless steel AISI 316L wall fixing plate. Frosted glass diffuser with silkscreen border, fixed through a robotic gluing system. 24V dc luminaire powered by a remote power supply to be ordered separately. For easy installation, a 3 modules junction box (model 503), where a single IP 65 power supply can also be placed, is available as an option.

Heavy Metal Spot 1

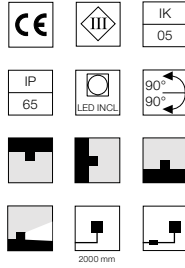
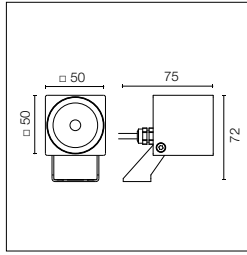

Source LED incluse. Source d'alimentation électrique à distance 24V dc ON/OFF à commander séparément. Équerre de maintien au mur incluse. Équipé d'un câble sortant de 250 mm en néoprène, et d'un kit avec des connecteurs sertissables et des gaines thermorétractables adhésives qui garantissent l'étanchéité de la connexion. Verre transparent extra-clair.

LED source included. Electric remote 24V dc ON/OFF power supply to be ordered separately. Wall fixing bracket included. The luminaire is equipped with a protruding, neoprene, 250 mm cable and a wiring kit with crimp connectors and adhesive heat-shrink tubing guaranteeing the water tightness of the connection. Extra clear transparent glass.

2200K disponible sur demande.

2200K available on request.

Optic Spot 10°

Power Led: 3,4W - 199 lm ≠ OUTPUT 138 lm - 2700K/CRI 80 - 24Vdc / 3,4W - 215 lm ≠ OUTPUT 149 lm - 3000K/CRI 80 - 24Vdc / 3,4W - 224 lm ≠ OUTPUT 155 lm - 4000K/CRI 80 - 24Vdc

2700K

○ FA50900501	201,00 €
● FA50900506	201,00 €
● FA50900512	201,00 €
● FA50900518	201,00 €
● FA50900530	201,00 €
● FA50900533	201,00 €

3000K

○ FA50900301	201,00 €
● FA50900306	201,00 €
● FA50900312	201,00 €
● FA50900318	201,00 €
● FA50900330	201,00 €
● FA50900333	201,00 €

4000K

○ FA50900201	201,00 €
● FA50900206	201,00 €
● FA50900212	201,00 €
● FA50900218	201,00 €
● FA50900230	201,00 €
● FA50900233	201,00 €

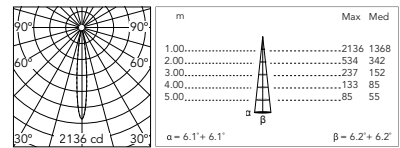

@ 3000K

Optic Medium 30°

Power Led: 3,4W - 199 lm ≠ OUTPUT 121 lm - 2700K/CRI 80 - 24Vdc / 3,4W - 215 lm ≠ OUTPUT 131 lm - 3000K/CRI 80 - 24Vdc / 3,4W - 224 lm ≠ OUTPUT 136 lm - 4000K/CRI 80 - 24Vdc

2700K

○ FA50901501	201,00 €
● FA50901506	201,00 €
● FA50901512	201,00 €
● FA50901518	201,00 €
● FA50901530	201,00 €
● FA50901533	201,00 €

3000K

○ FA50901301	201,00 €
● FA50901306	201,00 €
● FA50901312	201,00 €
● FA50901318	201,00 €
● FA50901330	201,00 €
● FA50901333	201,00 €

4000K

○ FA50901201	201,00 €
● FA50901206	201,00 €
● FA50901212	201,00 €
● FA50901218	201,00 €
● FA50901230	201,00 €
● FA50901233	201,00 €

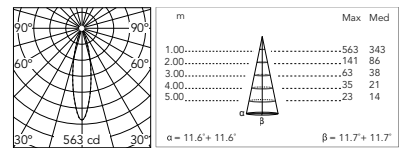

@ 3000K

* Nombre maximum de luminaires par source d'alimentation / Maximum number of luminaires per power supply.

Nombre maximum de luminaires par source d'alimentation (220÷240 V). Ces données doivent être vérifiées en prenant en compte les conditions spécifiques d'installation.	Maximum number of luminaires per power supply. (220÷240 V). These data must be checked taking into account the specific installation conditions.	Acc.			
		Acc. RF25754	1	Acc. RF25752	3
		Acc. RF25748	1	Acc. F990B28A000	9
		Acc. RF25747	2	Acc. F990B27A000	17
		Acc. RF25757	2		

Heavy Metal HP Spot 1

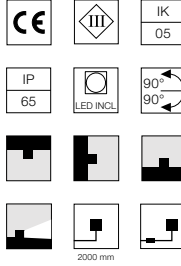
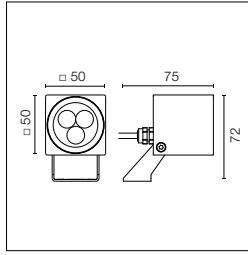

Source LED incluse. Source d'alimentation électrique à distance 24V dc ON/OFF à commander séparément. Équerre de maintien au mur incluse. Équipé d'un câble sortant de 250 mm en néoprène, et d'un kit avec des connecteurs sertissables et des gaines thermorétractables adhésives qui garantissent l'étanchéité de la connexion.
Verre transparent extra-clair.

LED source included. Electric remote 24V dc ON/OFF power supply to be ordered separately. Wall fixing bracket included. The luminaire is equipped with a protruding, neoprene, 250 mm cable and a wiring kit with crimp connectors and adhesive heat-shrink tubing guaranteeing the water tightness of the connection.
Extra clear transparent glass.

2200K disponible sur demande.

2200K available on request.

Optic Spot 10°

Power Led: 4,5W - 331 lm ≠ OUTPUT 246 lm - 2700K/CRI 80 - 24Vdc / 4,5W - 359 lm ≠ OUTPUT 267 lm - 3000K/CRI 80 - 24Vdc / 4,5W - 373 lm ≠ OUTPUT 277 lm - 4000K/CRI 80 - 24Vdc

2700K		3000K		4000K	
○ FA50902501	233,00 €	○ FA50902301	233,00 €	○ FA50902201	233,00 €
● FA50902506	233,00 €	● FA50902306	233,00 €	● FA50902206	233,00 €
● FA50902512	233,00 €	● FA50902312	233,00 €	● FA50902212	233,00 €
● FA50902518	233,00 €	● FA50902318	233,00 €	● FA50902218	233,00 €
● FA50902530	233,00 €	● FA50902330	233,00 €	● FA50902230	233,00 €
● FA50902533	233,00 €	● FA50902333	233,00 €	● FA50902233	233,00 €

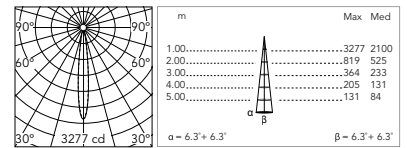

@ 3000K

Optic Medium 30°

Power Led: 4,5W - 331 lm ≠ OUTPUT 218 lm - 2700K/CRI 80 - 24Vdc / 4,5W - 359 lm ≠ OUTPUT 236 lm - 3000K/CRI 80 - 24Vdc / 4,5W - 373 lm ≠ OUTPUT 245 lm - 4000K/CRI 80 - 24Vdc

2700K		3000K		4000K	
○ FA50903501	233,00 €	○ FA50903301	233,00 €	○ FA50903201	233,00 €
● FA50903506	233,00 €	● FA50903306	233,00 €	● FA50903206	233,00 €
● FA50903512	233,00 €	● FA50903312	233,00 €	● FA50903212	233,00 €
● FA50903518	233,00 €	● FA50903318	233,00 €	● FA50903218	233,00 €
● FA50903530	233,00 €	● FA50903330	233,00 €	● FA50903230	233,00 €
● FA50903533	233,00 €	● FA50903333	233,00 €	● FA50903233	233,00 €

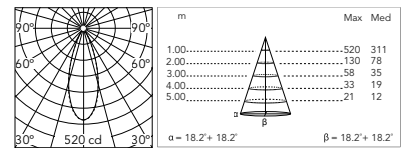

@ 3000K

* Nombre maximum de luminaires par source d'alimentation / Maximum number of luminaires per power supply.

Nombre maximum de luminaires par source d'alimentation (220÷240 V). Ces données doivent être vérifiées en prenant en compte les conditions spécifiques d'installation.	Maximum number of luminaires per power supply. (220÷240 V). These data must be checked taking into account the specific installation conditions.	Acc. RF25754	1	Acc. RF25757	2
		Acc. RF25748	1	Acc. F990B28A000	7
		Acc. RF25747	2	Acc. F990B27A000	14

Heavy Metal Spot 2

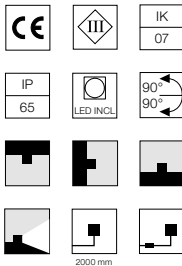
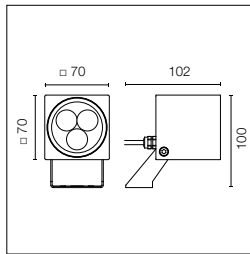

Source LED incluse. Source d'alimentation électrique à distance 24V dc ON/OFF à commander séparément. Équerre de maintien au mur incluse. Équipé d'un câble sortant de 250 mm en néoprène, et d'un kit avec des connecteurs sertissables et des gaines thermorétractables adhésives qui garantissent l'étanchéité de la connexion. Verre transparent extra-clair.

LED source included. Electric remote 24V dc ON/OFF power supply to be ordered separately. Wall fixing bracket included. The luminaire is equipped with a protruding, neoprene, 250 mm cable and a wiring kit with crimp connectors and adhesive heat-shrink tubing guaranteeing the water tightness of the connection. Extra clear transparent glass.

2200K disponible sur demande.

2200K available on request.

Optic Spot 10°

Power Led: 5,9W - 431 lm ≠ OUTPUT 359 lm - 2700K/CRI 80 - 24Vdc / 5,9W - 466 lm ≠ OUTPUT 389 lm - 3000K/CRI 80 - 24Vdc / 5,9W - 484 lm ≠ OUTPUT 404 lm - 4000K/CRI 80 - 24Vdc

2700K

- FA50904501 249,00 €
- FA50904506 249,00 €
- FA50904512 249,00 €
- FA50904518 249,00 €
- FA50904530 249,00 €
- FA50904533 249,00 €

3000K

- FA50904301 249,00 €
- FA50904306 249,00 €
- FA50904312 249,00 €
- FA50904318 249,00 €
- FA50904330 249,00 €
- FA50904333 249,00 €

4000K

- FA50904201 249,00 €
- FA50904206 249,00 €
- FA50904212 249,00 €
- FA50904218 249,00 €
- FA50904230 249,00 €
- FA50904233 249,00 €

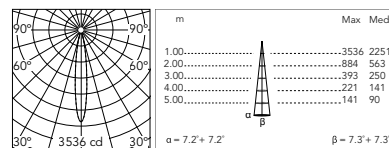

@ 3000K

Optic Medium 30°

Power Led: 5,9W - 431 lm ≠ OUTPUT 364 lm - 2700K/CRI 80 - 24Vdc / 5,9W - 466 lm ≠ OUTPUT 395 lm - 3000K/CRI 80 - 24Vdc / 5,9W - 484 lm ≠ OUTPUT 410 lm - 4000K/CRI 80 - 24Vdc

2700K

- FA50906501 249,00 €
- FA50906506 249,00 €
- FA50906512 249,00 €
- FA50906518 249,00 €
- FA50906530 249,00 €
- FA50906533 249,00 €

3000K

- FA50906301 249,00 €
- FA50906306 249,00 €
- FA50906312 249,00 €
- FA50906318 249,00 €
- FA50906330 249,00 €
- FA50906333 249,00 €

4000K

- FA50906201 249,00 €
- FA50906206 249,00 €
- FA50906212 249,00 €
- FA50906218 249,00 €
- FA50906230 249,00 €
- FA50906233 249,00 €

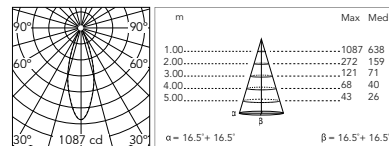

@ 3000K

Optic Flood 50°

Power Led: 5,9W - 431 lm ≠ OUTPUT 329 lm - 2700K/CRI 80 - 24Vdc / 5,9W - 466 lm ≠ OUTPUT 357 lm - 3000K/CRI 80 - 24Vdc / 5,9W - 484 lm ≠ OUTPUT 371 lm - 4000K/CRI 80 - 24Vdc

2700K

- FA50905501 249,00 €
- FA50905506 249,00 €
- FA50905512 249,00 €
- FA50905518 249,00 €
- FA50905530 249,00 €
- FA50905533 249,00 €

3000K

- FA50905301 249,00 €
- FA50905306 249,00 €
- FA50905312 249,00 €
- FA50905318 249,00 €
- FA50905330 249,00 €
- FA50905333 249,00 €

4000K

- FA50905201 249,00 €
- FA50905206 249,00 €
- FA50905212 249,00 €
- FA50905218 249,00 €
- FA50905230 249,00 €
- FA50905233 249,00 €

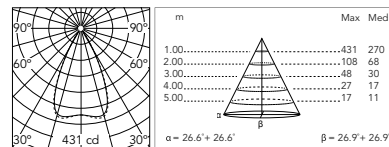

@ 3000K

* Nombre maximum de luminaires par source d'alimentation / Maximum number of luminaires per power supply.

Nombre maximum de luminaires par source d'alimentation (220-240 V). Ces données doivent être vérifiées en prenant en compte les conditions spécifiques d'installation.

Maximum number of luminaires per power supply. (220-240 V). These data must be checked taking into account the specific installation conditions.

Acc. RF25747 1
Acc. RF25757 1
Acc. RF25752 2

Acc. F990B28A000 6
Acc. F990B27A000 12

Heavy Metal Spot: Accessoires / Accessories

Pique pour la fixation au sol.

Ground spike.

FA136

34,00 €



Heavy Metal Spot: Appareillages électriques / Drivers

Source d'alimentation avec fonction dual Vout 24Vdc : 8W/100÷240V Iout 350ma: 6x1W/100÷240V IP20 Classe II Selv Eq.

Power supply dual function Vout 24Vdc: 8W/100÷240V Iout 350ma: 6x1W/100÷240V IP20 Class II Selv Eq.

*RF25754

36,00 €

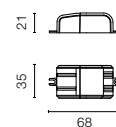

Équipement d'alimentation 24V 8W / 110-240V IP65 Classe II selv.

Power supply 24V 8W / 110-240V IP65 Class II selv.

*RF25748

63,00 €

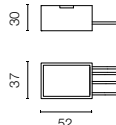

Équipement d'alimentation 24V 10W / 110-240V IP20 Classe II selv.

Power supply 24V 10W / 110-240V IP20 Class II selv.

*RF25747

48,00 €

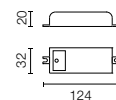

Équipement d'alimentation 24V 10W / 110-240V IP67 Classe II selv.

Power supply 24V 10W / 110-240V IP67 Class II selv.

*RF25757

86,00 €

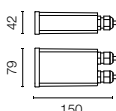

Équipement d'alimentation pour installation à distance 24Vdc 20W / 220-240V IP67 Classe II selv.

Power supply for remote installation 24Vdc 20W / 220-240V IP67 Class II selv.

*RF25752

133,00 €

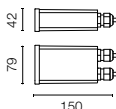

Alimentation 24Vdc 35W / 120-270V IP67 Class II selv.

Power supply 24Vdc 35W / 120-270V IP67 Class II selv.

F990B23AZ00

180,00 €

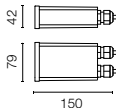

Équipement d'alimentation 24Vdc 50W / 120-240V IP67 Classe II selv.

Power supply 24Vdc 50W / 120-240V IP67 Class II selv.

*F990B28A000

251,00 €

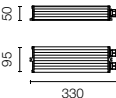

Équipement d'alimentation 24Vdc 70W / 220-240V IP67 Classe II selv.

Power supply 24Vdc 70W / 220-240V IP67 Class II selv.

*F990B27A000

212,00 €

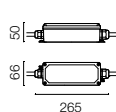

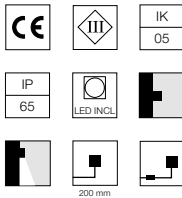
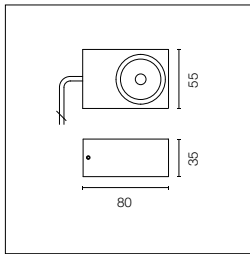

Source LED incluse. Source d'alimentation électrique à distance 24V dc ON/OFF à commander séparément. Équerre de maintien au mur incluse. Équipé d'un câble sortant de 250 mm en néoprène, et d'un kit avec des connecteurs sertissables et des gaines thermorétractables adhésives qui garantissent l'étanchéité de la connexion. Verre transparent extra-clair.

LED source included. Electric remote 24V dc ON/OFF power supply to be ordered separately. Wall fixing bracket included. The luminaire is equipped with a protruding, neoprene, 250 mm cable and a wiring kit with crimp connectors and adhesive heat-shrink tubing guaranteeing the water tightness of the connection. Extra clear transparent glass.

2200K disponible sur demande.

2200K available on request.

Optic Spot 10°

Power Led: 3,4W - 199 lm ≠ OUTPUT 138 lm - 2700K/CRI 80 - 24Vdc / 3,4W - 215 lm ≠ OUTPUT 149 lm - 3000K/CRI 80 - 24Vdc / 3,4W - 224 lm ≠ OUTPUT 155 lm - 4000K/CRI 80 - 24Vdc

2700K

- FA50800501 200,00 €
- FA50800506 200,00 €
- FA50800512 200,00 €
- FA50800518 200,00 €
- FA50800530 200,00 €
- FA50800533 200,00 €

3000K

- FA50800301 200,00 €
- FA50800306 200,00 €
- FA50800312 200,00 €
- FA50800318 200,00 €
- FA50800330 200,00 €
- FA50800333 200,00 €

4000K

- FA50800201 200,00 €
- FA50800206 200,00 €
- FA50800212 200,00 €
- FA50800218 200,00 €
- FA50800230 200,00 €
- FA50800233 200,00 €

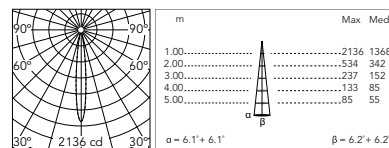

@ 3000K

Optic Medium 30°

Power Led: 3,4W - 199 lm ≠ OUTPUT 121 lm - 2700K/CRI 80 - 24Vdc / 3,4W - 215 lm ≠ OUTPUT 131 lm - 3000K/CRI 80 - 24Vdc / 3,4W - 224 lm ≠ OUTPUT 136 lm - 4000K/CRI 80 - 24Vdc

2700K

- FA50801501 200,00 €
- FA50801506 200,00 €
- FA50801512 200,00 €
- FA50801518 200,00 €
- FA50801530 200,00 €
- FA50801533 200,00 €

3000K

- FA50801301 200,00 €
- FA50801306 200,00 €
- FA50801312 200,00 €
- FA50801318 200,00 €
- FA50801330 200,00 €
- FA50801333 200,00 €

4000K

- FA50801201 200,00 €
- FA50801206 200,00 €
- FA50801212 200,00 €
- FA50801218 200,00 €
- FA50801230 200,00 €
- FA50801233 200,00 €

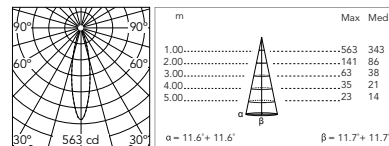

@ 3000K

* Nombre maximum de luminaires par source d'alimentation / Maximum number of luminaires per power supply.

Nombre maximum de luminaires par source d'alimentation (220-240 V). Ces données doivent être vérifiées en prenant en compte les conditions spécifiques d'installation.	Maximum number of luminaires per power supply. (220-240 V). These data must be checked taking into account the specific installation conditions.	Acc. RF25754	1	Acc. RF25752	3
		Acc. RF25748	1	Acc. F990B28A000	9
		Acc. RF25747	2	Acc. F990B27A000	17
		Acc. RF25757	2		

Heavy Metal HP Wall 1

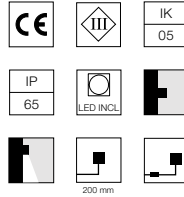
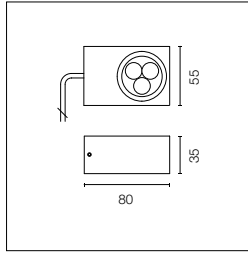

Source LED incluse. Source d'alimentation électrique à distance 24V dc ON/OFF à commander séparément. Équerre de maintien au mur incluse. Équipé d'un câble sortant de 250 mm en néoprène, et d'un kit avec des connecteurs sertissables et des gaines thermorétractables adhésives qui garantissent l'étanchéité de la connexion. Verre transparent extra-clair.

LED source included. Electric remote 24V dc ON/OFF power supply to be ordered separately. Wall fixing bracket included. The luminaire is equipped with a protruding, neoprene, 250 mm cable and a wiring kit with crimp connectors and adhesive heat-shrink tubing guaranteeing the water tightness of the connection. Extra clear transparent glass.

2200K disponible sur demande.

2200K available on request.

Optic Spot 10°

Power Led: 4,5W - 331 lm ≠ OUTPUT 246 lm - 2700K/CRI 80 - 24Vdc / 4,5W - 359 lm ≠ OUTPUT 267 lm - 3000K/CRI 80 - 24Vdc / 4,5W - 373 lm ≠ OUTPUT 277 lm - 4000K/CRI 80 - 24Vdc

2700K		3000K		4000K	
○ FA50802501	265,00 €	○ FA50802301	265,00 €	○ FA50802201	265,00 €
● FA50802506	265,00 €	● FA50802306	265,00 €	● FA50802206	265,00 €
● FA50802512	265,00 €	● FA50802312	265,00 €	● FA50802212	265,00 €
● FA50802518	265,00 €	● FA50802318	265,00 €	● FA50802218	265,00 €
● FA50802530	265,00 €	● FA50802330	265,00 €	● FA50802230	265,00 €
● FA50802533	265,00 €	● FA50802333	265,00 €	● FA50802233	265,00 €

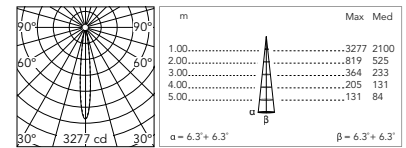

@ 3000K

Optic Medium 30°

Power Led: 4,5W - 331 lm ≠ OUTPUT 218 lm - 2700K/CRI 80 - 24Vdc / 4,5W - 359 lm ≠ OUTPUT 236 lm - 3000K/CRI 80 - 24Vdc / 4,5W - 373 lm ≠ OUTPUT 245 lm - 4000K/CRI 80 - 24Vdc

2700K		3000K		4000K	
○ FA50803501	265,00 €	○ FA50803301	265,00 €	○ FA50803201	265,00 €
● FA50803506	265,00 €	● FA50803306	265,00 €	● FA50803206	265,00 €
● FA50803512	265,00 €	● FA50803312	265,00 €	● FA50803212	265,00 €
● FA50803518	265,00 €	● FA50803318	265,00 €	● FA50803218	265,00 €
● FA50803530	265,00 €	● FA50803330	265,00 €	● FA50803230	265,00 €
● FA50803533	265,00 €	● FA50803333	265,00 €	● FA50803233	265,00 €

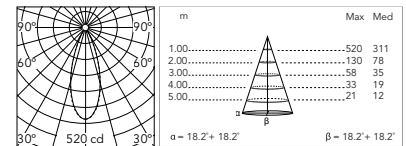







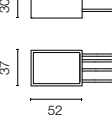

@ 3000K

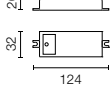
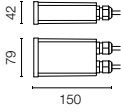
* Nombre maximum de luminaires par source d'alimentation / Maximum number of luminaires per power supply.

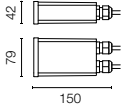
Nombre maximum de luminaires par source d'alimentation (220-240 V). Ces données doivent être vérifiées en prenant en compte les conditions spécifiques d'installation.	Maximum number of luminaires per power supply. (220-240 V). These data must be checked taking into account the specific installation conditions.	Acc. RF25754	1	Acc. RF25757	2
		Acc. RF25748	1	Acc. F990B28A000	7
		Acc. RF25747	2	Acc. F990B27A000	14

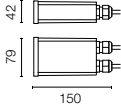
Heavy Metal Wall 1: Appareillages électriques / Drivers

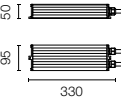
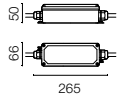
Source d'alimentation avec fonction dual Vout 24Vdc : 8W/100÷240V Iout 350ma: 6x1W/100÷240V IP20 Classe II Selv Eq.	Power supply dual function Vout 24Vdc: 8W/100÷240V Iout 350ma: 6x1W/100÷240V IP20 Class II Selv Eq.	*RF25754	36,00 €		
Équipement d'alimentation 24V 8W / 110-240V IP65 Classe II selv.	Power supply 24V 8W / 110-240V IP65 Class II selv.	*RF25748	63,00 €		
Équipement d'alimentation 24V 10W / 110-240V IP20 Classe II selv.	Power supply 24V 10W / 110-240V IP20 Class II selv.	*RF25747	48,00 €		
Équipement d'alimentation 24V 10W / 110-240V IP67 Classe II selv.	Power supply 24V 10W / 110-240V IP67 Class II selv.	*RF25757	86,00 €		
Équipement d'alimentation pour installation à distance 24Vdc 20W / 220-240V IP67 Classe II selv.	Power supply for remote installation 24Vdc 20W / 220-240V IP67 Class II selv.	Heavy Metal Wall 1 2,2W *RF25752	133,00 €		
Alimentation 24Vdc 35W / 120-270V IP67 Class II selv.	Power supply 24Vdc 35W / 120-270V IP67 Class II selv.	F990B23AZ00	180,00 €		
Équipement d'alimentation 24Vdc 50W / 120-240V IP67 Classe II selv.	Power supply 24Vdc 50W / 120-240V IP67 Class II selv.	*F990B28A000	251,00 €		
Équipement d'alimentation 24Vdc 70W / 220-240V IP67 Classe II selv.	Power supply 24Vdc 70W / 220-240V IP67 Class II selv.	*F990B27A000	212,00 €		

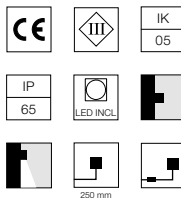
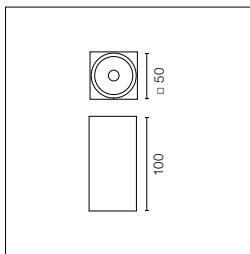

Source LED incluse. Source d'alimentation électrique à distance 24V dc ON/OFF à commander séparément. Équerre de maintien au mur incluse. Équipé d'un câble sortant de 250 mm en néoprène, et d'un kit avec des connecteurs sertissables et des gaines thermorétractables adhésives qui garantissent l'étanchéité de la connexion. Verre transparent extra-clair.

LED source included. Electric remote 24V dc ON/OFF power supply to be ordered separately. Wall fixing bracket included. The luminaire is equipped with a protruding, neoprene, 250 mm cable and a wiring kit with crimp connectors and adhesive heat-shrink tubing guaranteeing the water tightness of the connection. Extra clear transparent glass.

2200K disponible sur demande.

2200K available on request.

Optic Spot 10°

Power Led: 3,4W - 199 lm ≠ OUTPUT 138 lm - 2700K/CRI 80 - 24Vdc / 3,4W - 215 lm ≠ OUTPUT 149 lm - 3000K/CRI 80 - 24Vdc / 3,4W - 224 lm ≠ OUTPUT 155 lm - 4000K/CRI 80 - 24Vdc

2700K		3000K		4000K	
○ FA50700501	201,00 €	○ FA50700301	201,00 €	○ FA50700201	201,00 €
● FA50700506	201,00 €	● FA50700306	201,00 €	● FA50700206	201,00 €
● FA50700512	201,00 €	● FA50700312	201,00 €	● FA50700212	201,00 €
● FA50700518	201,00 €	● FA50700318	201,00 €	● FA50700218	201,00 €
● FA50700530	201,00 €	● FA50700330	201,00 €	● FA50700230	201,00 €
● FA50700533	201,00 €	● FA50700333	201,00 €	● FA50700233	201,00 €

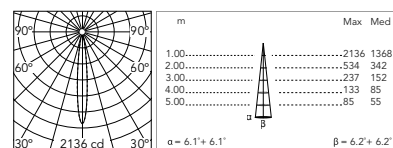

@ 3000K

Optic Medium 30°

Power Led: 3,4W - 199 lm ≠ OUTPUT 121 lm - 2700K/CRI 80 - 24Vdc / 3,4W - 215 lm ≠ OUTPUT 131 lm - 3000K/CRI 80 - 24Vdc / 3,4W - 224 lm ≠ OUTPUT 136 lm - 4000K/CRI 80 - 24Vdc

2700K		3000K		4000K	
○ FA50701501	201,00 €	○ FA50701301	201,00 €	○ FA50701201	201,00 €
● FA50701506	201,00 €	● FA50701306	201,00 €	● FA50701206	201,00 €
● FA50701512	201,00 €	● FA50701312	201,00 €	● FA50701212	201,00 €
● FA50701518	201,00 €	● FA50701318	201,00 €	● FA50701218	201,00 €
● FA50701530	201,00 €	● FA50701330	201,00 €	● FA50701230	201,00 €
● FA50701533	201,00 €	● FA50701333	201,00 €	● FA50701233	201,00 €

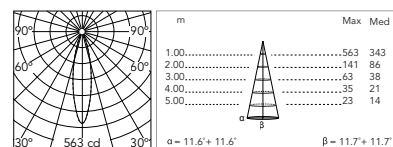

@ 3000K

* Nombre maximum de luminaires par source d'alimentation / Maximum number of luminaires per power supply.

Nombre maximum de luminaires par source d'alimentation (220÷240 V). Ces données doivent être vérifiées en prenant en compte les conditions spécifiques d'installation.	Maximum number of luminaires per power supply. (220÷240 V). These data must be checked taking into account the specific installation conditions.	Acc. RF25754	1	Acc. RF25752	3
		Acc. RF25748	1	Acc. F990B28A000	9
		Acc. RF25747	2	Acc. F990B27A000	17
		Acc. RF25757	2		

Heavy Metal HP Wall 2 Mono

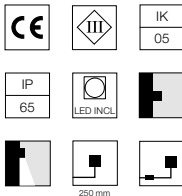
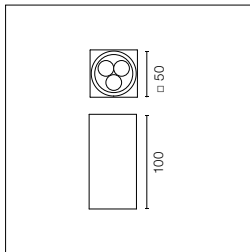

Source LED incluse. Source d'alimentation électrique à distance 24V dc ON/OFF à commander séparément. Équerre de maintien au mur incluse. Équipé d'un câble sortant de 250 mm en néoprène, et d'un kit avec des connecteurs sertissables et des gaines thermorétractables adhésives qui garantissent l'étanchéité de la connexion. Verre transparent extra-clair.

LED source included. Electric remote 24V dc ON/OFF power supply to be ordered separately. Wall fixing bracket included. The luminaire is equipped with a protruding, neoprene, 250 mm cable and a wiring kit with crimp connectors and adhesive heat-shrink tubing guaranteeing the water tightness of the connection. Extra clear transparent glass.

2200K disponible sur demande.

2200K available on request.

Optic Spot 10°

Power Led: 4,5W - 331 lm ≠ OUTPUT 246 lm - 2700K/CRI 80 - 24Vdc / 4,5W - 359 lm ≠ OUTPUT 267 lm - 3000K/CRI 80 - 24Vdc / 4,5W - 373 lm ≠ OUTPUT 277 lm - 4000K/CRI 80 - 24Vdc

2700K

○ FA50702501	219,00 €
● FA50702506	219,00 €
● FA50702512	219,00 €
● FA50702518	219,00 €
● FA50702530	219,00 €
● FA50702533	219,00 €

3000K

○ FA50702301	219,00 €
● FA50702306	219,00 €
● FA50702312	219,00 €
● FA50702318	219,00 €
● FA50702330	219,00 €
● FA50702333	219,00 €

4000K

○ FA50702201	219,00 €
● FA50702206	219,00 €
● FA50702212	219,00 €
● FA50702218	219,00 €
● FA50702230	219,00 €
● FA50702233	219,00 €

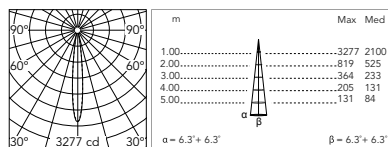

@ 3000K

Optic Medium 30°

Power Led: 4,5W - 331 lm ≠ OUTPUT 218 lm - 2700K/CRI 80 - 24Vdc / 4,5W - 359 lm ≠ OUTPUT 236 lm - 3000K/CRI 80 - 24Vdc / 4,5W - 373 lm ≠ OUTPUT 245 lm - 4000K/CRI 80 - 24Vdc

2700K

○ FA50703501	219,00 €
● FA50703506	219,00 €
● FA50703512	219,00 €
● FA50703518	219,00 €
● FA50703530	219,00 €
● FA50703533	219,00 €

3000K

○ FA50703301	219,00 €
● FA50703306	219,00 €
● FA50703312	219,00 €
● FA50703318	219,00 €
● FA50703330	219,00 €
● FA50703333	219,00 €

4000K

○ FA50703201	219,00 €
● FA50703206	219,00 €
● FA50703212	219,00 €
● FA50703218	219,00 €
● FA50703230	219,00 €
● FA50703233	219,00 €

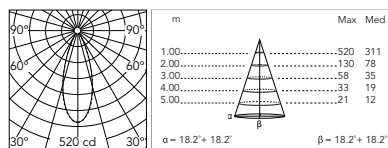

@ 3000K

* Nombre maximum de luminaires par source d'alimentation / Maximum number of luminaires per power supply.

Nombre maximum de luminaires par source d'alimentation (220÷240 V). Ces données doivent être vérifiées en prenant en compte les conditions spécifiques d'installation.

Maximum number of luminaires per power supply (220÷240 V). These data must be checked taking into account the specific installation conditions.

Acc. RF25754	1	Acc. RF25757	2
Acc. RF25748	1	Acc. F990B28A000	7
Acc. RF25747	2	Acc. F990B27A000	14

Heavy Metal Wall 2 Double

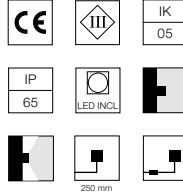
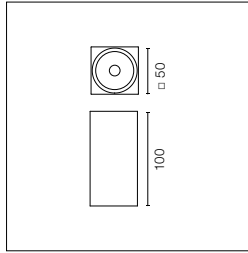

Source LED incluse. Source d'alimentation électrique à distance 24V dc ON/OFF à commander séparément. Équerre de maintien au mur incluse. Équipé d'un câble sortant de 250 mm en néoprène, et d'un kit avec des connecteurs sertissables et des gaines thermorétractables adhésives qui garantissent l'étanchéité de la connexion.
Verre transparent extra-clair.

LED source included. Electric remote 24V dc ON/OFF power supply to be ordered separately. Wall fixing bracket included. The luminaire is equipped with a protruding, neoprene, 250 mm cable and a wiring kit with crimp connectors and adhesive heat-shrink tubing guaranteeing the water tightness of the connection.
Extra clear transparent glass.

2200K disponible sur demande.

2200K available on request.

Optic Spot 10°

Power Led: 6,8W - 2x199 lm ≠ OUTPUT 2x138 lm - 2700K/CRI 80 - 24Vdc / 6,8W - 2x215 lm ≠ OUTPUT 2x149 lm - 3000K/CRI 80 - 24Vdc / 6,8W - 2x224 lm ≠ OUTPUT 2x155 lm - 4000K/CRI 80 - 24Vdc

2700K		3000K		4000K	
○ FA50710501	249,00 €	○ FA50710301	249,00 €	○ FA50710201	249,00 €
● FA50710506	249,00 €	● FA50710306	249,00 €	● FA50710206	249,00 €
● FA50710512	249,00 €	● FA50710312	249,00 €	● FA50710212	249,00 €
● FA50710518	249,00 €	● FA50710318	249,00 €	● FA50710218	249,00 €
● FA50710530	249,00 €	● FA50710330	249,00 €	● FA50710230	249,00 €
● FA50710533	249,00 €	● FA50710333	249,00 €	● FA50710233	249,00 €

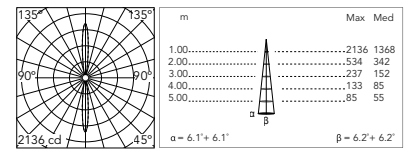

@ 3000K

Optic Medium 30°

Power Led: 6,8W - 2x199 lm ≠ OUTPUT 2x121 lm - 2700K/CRI 80 - 24Vdc / 6,8W - 2x215 lm ≠ OUTPUT 2x131 lm - 3000K/CRI 80 - 24Vdc / 6,8W - 2x224 lm ≠ OUTPUT 2x136 lm - 4000K/CRI 80 - 24Vdc

2700K		3000K		4000K	
○ FA50711501	249,00 €	○ FA50711301	249,00 €	○ FA50711201	249,00 €
● FA50711506	249,00 €	● FA50711306	249,00 €	● FA50711206	249,00 €
● FA50711512	249,00 €	● FA50711312	249,00 €	● FA50711212	249,00 €
● FA50711518	249,00 €	● FA50711318	249,00 €	● FA50711218	249,00 €
● FA50711530	249,00 €	● FA50711330	249,00 €	● FA50711230	249,00 €
● FA50711533	249,00 €	● FA50711333	249,00 €	● FA50711233	249,00 €

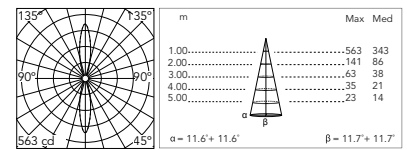

@ 3000K

* Nombre maximum de luminaires par source d'alimentation / Maximum number of luminaires per power supply.

Nombre maximum de luminaires par source d'alimentation (220-240 V). Ces données doivent être vérifiées en prenant en compte les conditions spécifiques d'installation.

Maximum number of luminaires per power supply. (220-240 V). These data must be checked taking into account the specific installation conditions.

Acc. RF25747 1
Acc. RF25757 1
Acc. RF25752 2

Acc. F990B28A000 5
Acc. F990B27A000 8

Heavy Metal HP Wall 2 Double

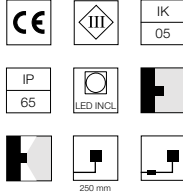
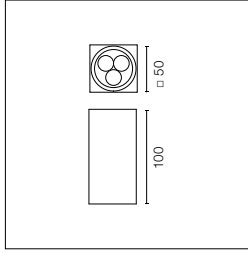

Source LED incluse. Source d'alimentation électrique à distance 24V dc ON/OFF à commander séparément. Équerre de maintien au mur incluse. Équipé d'un câble sortant de 250 mm en néoprène, et d'un kit avec des connecteurs sertissables et des gaines thermorétractables adhésives qui garantissent l'étanchéité de la connexion. Verre transparent extra-clair.

LED source included. Electric remote 24V dc ON/OFF power supply to be ordered separately. Wall fixing bracket included. The luminaire is equipped with a protruding, neoprene, 250 mm cable and a wiring kit with crimp connectors and adhesive heat-shrink tubing guaranteeing the water tightness of the connection. Extra clear transparent glass.

2200K disponible sur demande.

2200K available on request.

Optic Spot 10°

Power Led: 9W - 2x331 lm ≠ OUTPUT 2x246 lm - 2700K/CRI 80 - 24Vdc / 9W - 2x359 lm ≠ OUTPUT 2x267 lm - 3000K/CRI 80 - 24Vdc / 9W - 2x373 lm ≠ OUTPUT 2x277 lm - 4000K/CRI 80 - 24Vdc

2700K

○ FA50712501	265,00 €
● FA50712506	265,00 €
● FA50712512	265,00 €
● FA50712518	265,00 €
● FA50712530	265,00 €
● FA50712533	265,00 €

3000K

○ FA50712301	265,00 €
● FA50712306	265,00 €
● FA50712312	265,00 €
● FA50712318	265,00 €
● FA50712330	265,00 €
● FA50712333	265,00 €

4000K

○ FA50712201	265,00 €
● FA50712206	265,00 €
● FA50712212	265,00 €
● FA50712218	265,00 €
● FA50712230	265,00 €
● FA50712233	265,00 €

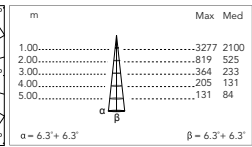
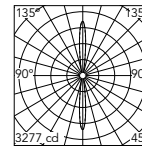

@ 3000K

Optic Medium 30°

Power Led: 9W - 2x331 lm ≠ OUTPUT 2x218 lm - 2700K/CRI 80 - 24Vdc / 9W - 2x359 lm ≠ OUTPUT 2x236 lm - 3000K/CRI 80 - 24Vdc / 9W - 2x373 lm ≠ OUTPUT 2x245 lm - 4000K/CRI 80 - 24Vdc

2700K

○ FA50713501	265,00 €
● FA50713506	265,00 €
● FA50713512	265,00 €
● FA50713518	265,00 €
● FA50713530	265,00 €
● FA50713533	265,00 €

3000K

○ FA50713301	265,00 €
● FA50713306	265,00 €
● FA50713312	265,00 €
● FA50713318	265,00 €
● FA50713330	265,00 €
● FA50713333	265,00 €

4000K

○ FA50713201	265,00 €
● FA50713206	265,00 €
● FA50713212	265,00 €
● FA50713218	265,00 €
● FA50713230	265,00 €
● FA50713233	265,00 €

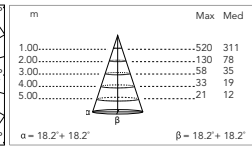
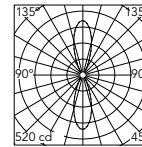



@ 3000K

* Nombre maximum de luminaires par source d'alimentation / Maximum number of luminaires per power supply.

Nombre maximum de luminaires par source d'alimentation (220÷240 V). Ces données doivent être vérifiées en prenant en compte les conditions spécifiques d'installation.	Maximum number of luminaires per power supply. (220÷240 V). These data must be checked taking into account the specific installation conditions.	Acc. RF25747	1
		Acc. RF25757	1
		Acc. F990B28A000	3
		Acc. F990B27A000	7

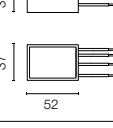
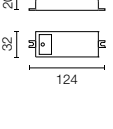
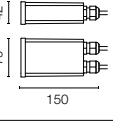
Heavy Metal Wall 2: Appareillages électriques / Drivers

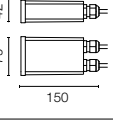
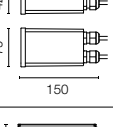
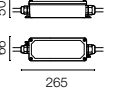
Source d'alimentation avec fonction dual Vout 24Vdc : 8W/100÷240V Iout 350ma: 6x1W/100÷240V IP20 Classe II Selv Eq.	Power supply dual function Vout 24Vdc: 8W/100÷240V Iout 350ma: 6x1W/100÷240V IP20 Class II Selv Eq.	Heavy Metal Wall 2 Mono *RF25754	36,00 €		
Équipement d'alimentation 24V 8W / 110-240V IP65 Classe II selv.	Power supply 24V 8W / 110-240V IP65 Class II selv.	Heavy Metal Wall 2 Double *RF25748	63,00 €		
Équipement d'alimentation 24V 10W / 110-240V IP20 Classe II selv.	Power supply 24V 10W / 110-240V IP20 Class II selv.	*RF25747	48,00 €		
Équipement d'alimentation 24V 10W / 110-240V IP67 Classe II selv.	Power supply 24V 10W / 110-240V IP67 Class II selv.	*RF25757	86,00 €		
Équipement d'alimentation pour installation à distance 24Vdc 20W / 220-240V IP67 Classe II selv.	Power supply for remote installation 24Vdc 20W / 220-240V IP67 Class II selv.	*RF25752	133,00 €		
Alimentation 24Vdc 35W / 120-270V IP67 Class II selv.	Power supply 24Vdc 35W / 120-270V IP67 Class II selv.	F990B23AZ00	180,00 €		
Équipement d'alimentation 24Vdc 50W / 120-240V IP67 Classe II selv.	Power supply 24Vdc 50W / 120-240V IP67 Class II selv.	*F990B28A000	251,00 €		
Équipement d'alimentation 24Vdc 70W / 220-240V IP67 Classe II selv.	Power supply 24Vdc 70W / 220-240V IP67 Class II selv.	*F990B27A000	212,00 €		

Heavy Metal Wall 3 Mono

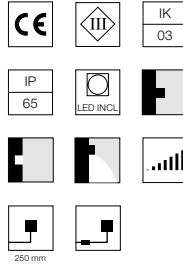
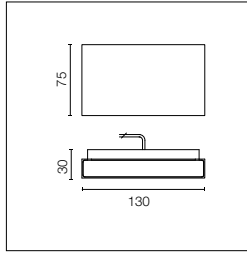

Source LED incluse. Source d'alimentation électrique à distance 24V dc ON/OFF à commander séparément. Équerre de maintien au mur incluse. Équipé d'un câble sortant de 250 mm en néoprène, et d'un kit avec des connecteurs sertissables et des gaines thermorétractables adhésives qui garantissent l'étanchéité de la connexion. Verre transparent extra-clair.

LED source included. Electric remote 24V dc ON/OFF power supply to be ordered separately. Wall fixing bracket included. The luminaire is equipped with a protruding, neoprene, 250 mm cable and a wiring kit with crimp connectors and adhesive heat-shrink tubing guaranteeing the water tightness of the connection. Extra clear transparent glass.

2200K disponible sur demande.

2200K available on request.

Mid-Power Led: 2,5W - 246 lm ≠ OUTPUT 162 lm - 2700K/CRI 80 - 24Vdc / 2,5W - 265 lm ≠ OUTPUT 168 lm - 3000K/CRI 80 - 24Vdc / 2,5W - 278 lm ≠ OUTPUT 174 lm - 4000K/CRI 80 - 24Vdc

2700K

○ FA51200501	187,00 €
● FA51200506	187,00 €
● FA51200512	187,00 €
● FA51200518	187,00 €
● FA51200530	187,00 €
● FA51200533	187,00 €

3000K

○ FA51200301	187,00 €
● FA51200306	187,00 €
● FA51200312	187,00 €
● FA51200318	187,00 €
● FA51200330	187,00 €
● FA51200333	187,00 €

4000K

○ FA51200201	187,00 €
● FA51200206	187,00 €
● FA51200212	187,00 €
● FA51200218	187,00 €
● FA51200230	187,00 €
● FA51200233	187,00 €

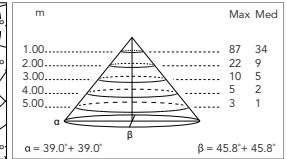
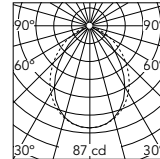

@ 3000K

* Nombre maximum de luminaires par source d'alimentation / Maximum number of luminaires per power supply.

Nombre maximum de luminaires par source d'alimentation (220-240 V). Ces données doivent être vérifiées en prenant en compte les conditions spécifiques d'installation.

Maximum number of luminaires per power supply. (220-240 V). These data must be checked taking into account the specific installation conditions.

Acc. RF25754	3	Acc. RF26387.A	6
Acc. RF25748	3	Acc. RF25752	8
Acc. RF25747	4	Acc. F990B28A000	20
Acc. RF25757	4	Acc. F990B27A000	25
Acc. RF25750	6	Acc. F990B29A000	35
Acc. F990B21A000	6		

Heavy Metal Wall 3 Double

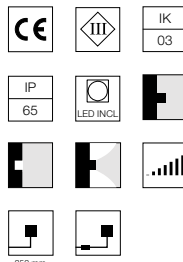
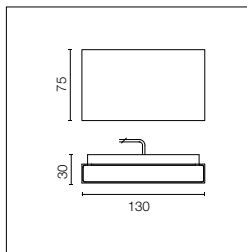

Source LED incluse. Source d'alimentation électrique à distance 24V dc ON/OFF à commander séparément. Équerre de maintien au mur incluse. Équipé d'un câble sortant de 250 mm en néoprène, et d'un kit avec des connecteurs sertissables et des gaines thermorétractables adhésives qui garantissent l'étanchéité de la connexion. Verre transparent extra-clair.

LED source included. Electric remote 24V dc ON/OFF power supply to be ordered separately. Wall fixing bracket included. The luminaire is equipped with a protruding, neoprene, 250 mm cable and a wiring kit with crimp connectors and adhesive heat-shrink tubing guaranteeing the water tightness of the connection. Extra clear transparent glass.

2200K disponible sur demande.

2200K available on request.

Mid-Power Led: 5W - 2x246 lm ≠ OUTPUT 2x162 lm - 2700K/CRI 80 - 24Vdc / 5W - 2x265 lm ≠ OUTPUT 2x168 lm - 3000K/CRI 80 - 24Vdc / 5W - 2x278 lm ≠ OUTPUT 2x174 lm - 4000K/CRI 80 - 24Vdc

2700K

○ FA51201501	232,00 €
● FA51201506	232,00 €
● FA51201512	232,00 €
● FA51201518	232,00 €
● FA51201530	232,00 €
● FA51201533	232,00 €

3000K

○ FA51201301	232,00 €
● FA51201306	232,00 €
● FA51201312	232,00 €
● FA51201318	232,00 €
● FA51201330	232,00 €
● FA51201333	232,00 €

4000K

○ FA51201201	232,00 €
● FA51201206	232,00 €
● FA51201212	232,00 €
● FA51201218	232,00 €
● FA51201230	232,00 €
● FA51201233	232,00 €

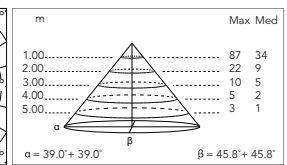
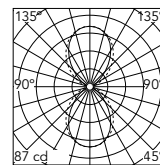

@ 3000K

* Nombre maximum de luminaires par source d'alimentation / Maximum number of luminaires per power supply.

Nombre maximum de luminaires par source d'alimentation (220-240 V). Ces données doivent être vérifiées en prenant en compte les conditions spécifiques d'installation.

Maximum number of luminaires per power supply. (220-240 V). These data must be checked taking into account the specific installation conditions.

Acc. RF25754	1	Acc. RF26387.A	3
Acc. RF25748	1	Acc. RF25752	4
Acc. RF25747	2	Acc. F990B28A000	10
Acc. RF25757	2	Acc. F990B27A000	13
Acc. RF25750	3	Acc. F990B29A000	17
Acc. F990B21A000	3		

Heavy Metal Wall 3: Accessoires / Accessories

Boitier de dérivation à encastrer 3 modules (modèle 503) 106x75 H55mm.

Recessed 3-module junction box (model 503) 106 x 75 H 55 mm.

Heavy Metal Wall 3
F990H010000

12,00 €

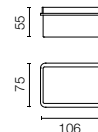

Heavy Metal Wall 3 Installation acc. F990H010000

Heavy Metal Wall 3 avec boîte encastrable.
Optionnel : source d'alimentation art.106 dans boîte encastrable.

Heavy Metal Wall 3 with box.
Optional: power supply code 106 in recessed box.

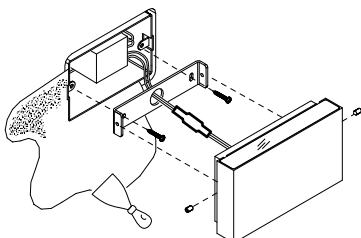

Heavy Metal Wall 3 Installation acc. F990H010000

Heavy Metal Wall 3 sans boîte encastrable.

Heavy Metal Wall 3 without box.

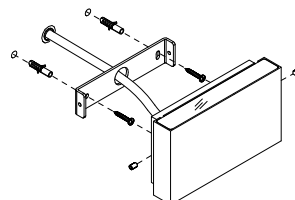

Heavy Metal Wall 3: Appareillages électriques / Drivers

Source d'alimentation avec fonction dual Vout 24Vdc : 8W/100÷240V Iout 350ma: 6x1W/100÷240V IP20 Classe II Selv Eq.

Power supply dual function Vout 24Vdc: 8W/100÷240V Iout 350ma: 6x1W/100÷240V IP20 Class II Selv Eq.

*RF25754

36,00 €

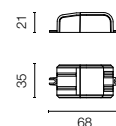

Équipement d'alimentation 24Vdc 8W / 110-240V IP65 Classe II selv.

Power supply 24Vdc 8W / 110-240V IP65 Class II selv.

*RF25748

63,00 €

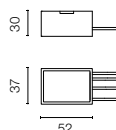

Équipement d'alimentation pour installation à distance 24Vdc 10W / 110-240V IP20 Classe II selv.

Power supply for remote installation 24Vdc 10W / 110-240V IP20 Class II selv.

*RF25747

48,00 €

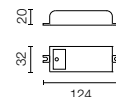

Équipement d'alimentation 24V 10W / 110-240V IP67 Classe II selv.

Power supply 24V 10W / 110-240V IP67 Class II selv.

*RF25757

86,00 €

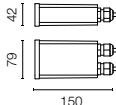

Équipement d'alimentation pour installation à distance 24Vdc 17W / 110-240V (15W@110V) IP20 Classe II selv.

Power supply for remote installation 24Vdc 17W / 110-240V (15W@110V) IP20 Class II selv.

*RF25750

Dimmable 1-10V

96,00 €

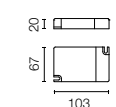

Équipement d'alimentation 17W/110÷240V - 24Vdc (15W@110V) IP67 Classe II selv.

Power supply 17W/110÷240V - 24Vdc (15W@110V) IP67 Class II Selv.

*F990B21A000

159,00 €

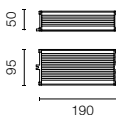

Équipement d'alimentation pour installation à distance 24Vdc 20W / 110-240Vdc (15W@110V) IP67 Classe II selv.

Power supply for remote installation 24Vdc 20W / 110-240Vdc (15W@110V) IP67 Class II selv.

*RF26387.A

Dimmable DALI

159,00 €

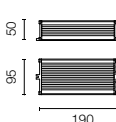

Heavy Metal Wall 3: Appareillages électriques / Drivers

<p>Équipement d'alimentation pour installation à distance 24Vdc 20W / 220-240V IP67 Classe II selv.</p>	<p>Power supply for remote installation 24Vdc 20W / 220-240V IP67 Class II selv.</p>	<p>*RF25752</p>	<p>133,00 €</p>		
<p>Équipement d'alimentation pour installation à distance 24Vdc 50W / 120-240V IP67 Classe II selv.</p>	<p>Power supply for remote installation 24Vdc 50W / 120-240V IP67 Class II selv.</p>	<p>*F990B28A000</p>	<p>251,00 €</p>		
<p>Alimentation 24Vdc 35W / 120-270V IP67 Classe II selv.</p>	<p>Power supply 24Vdc 35W / 120-270V IP67 Class II selv.</p>	<p>F990B23AZ00</p>	<p>180,00 €</p>		
<p>Équipement d'alimentation pour installation à distance 24Vdc 70W / 220-240V IP67 Classe II selv.</p>	<p>Power supply for remote installation 24Vdc 70W / 220-240V IP67 Class II selv.</p>	<p>*F990B27A000</p>	<p>212,00 €</p>		
<p>Équipement d'alimentation pour installation à distance 24Vdc 96W / 120-240V IP67 Classe II selv.</p>	<p>Power supply for remote installation 24Vdc 96W / 120-240V IP67 Class II selv.</p>	<p>*F990B29A000</p>	<p>300,00 €</p>		

Fenestra

Designed by Flos Outdoor







Fenestra

Famille / Family

Fenestra 24V



Power Led

4W
165 lm - 2700K/CRI 80
183 lm - 3000K/CRI 80
201 lm - 4000K/CRI 80

Fenestra



Power Led

5,5W
165 lm - 2700K/CRI 80
183 lm - 3000K/CRI 80
201 lm - 4000K/CRI 80

Finitions / Colours



01 White

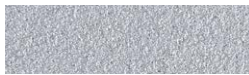

06 Grey

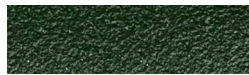

12 Forest Green



18 Deep Brown



30 Black



33 Anthracite

Description / Description

Appareil d'extérieur à LED pour baie vitrée.

Corps en aluminium moulé sous pression EN AB-47100 à faible teneur en cuivre.

Revêtement à haute résistance : après un traitement de sablage de tous les composants pour rendre la surface poreuse et garantir une meilleure adhérence de la peinture, le revêtement externe est appliqué en double couche avec des poudres selon le label QUALICOAT. La première couche de poudres époxydiques assure la résistance chimique et mécanique. La seconde couche de finition de poudres polyester garantit la résistance aux rayons UV et aux agents atmosphériques.

Les surfaces peintes sont traitées par lavages alcalins et acides, rincées à l'eau déminéralisée puis soumises à un traitement de conversion chimique pour les protéger de l'oxydation.

L'utilisation d'une double LED et de deux lentilles à émission lamellaire garantit une couverture lumineuse à 270° avec une distribution homogène et une uniformité chromatique optimale.

Diffuseur en polycarbonate stabilisé aux rayons UV, joints en silicone.

Chaque luminaire dispose d'un système mécanique de régulation allant jusqu'à 10° qui permet de compenser l'inclinaison du rebord pour orienter ainsi correctement le faisceau lumineux.

Luminaire for outdoor use for installation in a window compartment with LED light source.

Luminaire body in die-cast aluminum EN AB-47100 (low copper content).

High-resistance coating: after a sandblasting treatment of all components to make the surface porous and ensure a greater adhesion of the paint, the external coating is applied with a double layer with epoxy powders according to the QUALICOAT standard. The first layer of epoxy powder gives chemical and mechanical resistance, the second finishing layer of polyester powder ensures resistance to UV rays and atmospheric agents.

The painted surfaces are treated with alkaline and acidic washes, then rinsed with demineralized water, subjected to a chemical conversion treatment to protect against oxidation.

Thanks to the use of a dual LED source and two laminar emitting lenses, it guarantees a coverage of 270° with homogeneous distribution and excellent color uniformity.

UV-stabilized polycarbonate diffuser, silicone seal.

Each luminaire is equipped with a mechanical adjustment system of up to 10° to compensate the tilting of the parapet and thus correctly orient the light beam.

Fenestra 24V

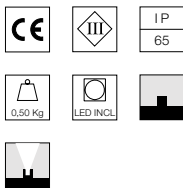
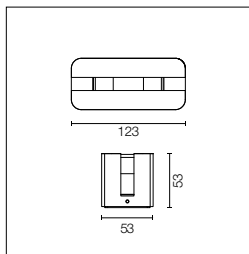

Alimentation électrique à distance 12-24V à commander séparément. Pré-câblé avec câble sortant en néoprène de 1000 mm.

12-24V remote power supply to be ordered separately. Equipped with a 1000 mm length outgoing neoprene cable.

Power Led: 4W - 274 lm ≠ FIXT 165 lm - 2700K/CRI 80 - 12-24V / 4W - 304 lm ≠ FIXT 183 lm - 3000K/CRI 80 - 12-24V / 4W - 334 lm ≠ FIXT 201 lm - 4000K/CRI 80 - 12-24V

2700K

○ F2250001	203,00 €
● F2250006	203,00 €
● F2250012	203,00 €
● F2250018	203,00 €
● F2250030	203,00 €
● F2250033	203,00 €

3000K

○ F2251001	203,00 €
● F2251006	203,00 €
● F2251012	203,00 €
● F2251018	203,00 €
● F2251030	203,00 €
● F2251033	203,00 €

4000K

○ F2252001	203,00 €
● F2252006	203,00 €
● F2252012	203,00 €
● F2252018	203,00 €
● F2252030	203,00 €
● F2252033	203,00 €

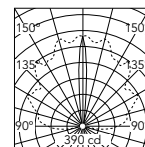

Beam Angle: 10°

h(m)	E(lx)	D(m)
1	390	0.17
2	97	0.34
3	43	0.51
4	24	0.68
5	16	0.85

@4000K

Fenestra

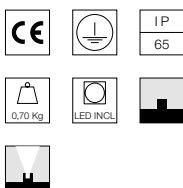
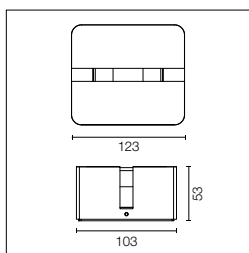

Alimentation 100/240V intégrée. Pré-câblé avec câble sortant en néoprène de 1000 mm. Version dimmable sur demande.

Integrated 100/240V power supply. Equipped with a 1000 mm length outgoing neoprene cable. Dimmable version on request.

Power Led: 5,5W - 274 lm ≠ FIXT 165 lm - 2700K/CRI 80 - 100-240V / 5,5W - 304 lm ≠ FIXT 183 lm - 3000K/CRI 80 - 100-240V / 5,5W - 334 lm ≠ FIXT 201 lm - 4000K/CRI 80 - 100-240V

2700K

○ F2260001	246,00 €
● F2260006	246,00 €
● F2260012	246,00 €
● F2260018	246,00 €
● F2260030	246,00 €
● F2260033	246,00 €

3000K

○ F2261001	246,00 €
● F2261006	246,00 €
● F2261012	246,00 €
● F2261018	246,00 €
● F2261030	246,00 €
● F2261033	246,00 €

4000K

○ F2262001	246,00 €
● F2262006	246,00 €
● F2262012	246,00 €
● F2262018	246,00 €
● F2262030	246,00 €
● F2262033	246,00 €

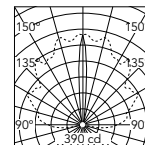

Beam Angle: 10°

h(m)	E(lx)	D(m)
1	390	0.17
2	97	0.34
3	43	0.51
4	24	0.68
5	16	0.85

@4000K

Réglage du luminaire pour les surfaces d'appui non planes Luminaire adjustment for non-planar surfaces

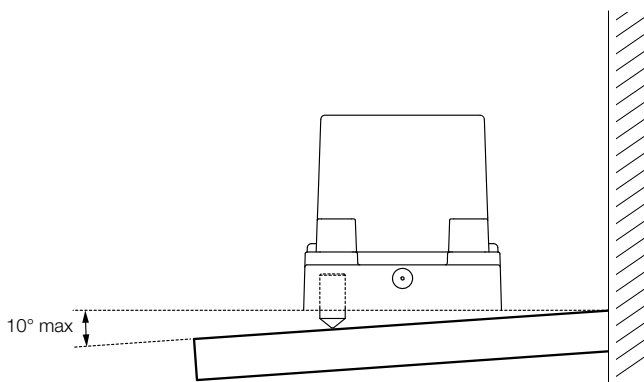

Fenestra 24V: Accessoires / Accessories

Dispositif de protection contre les surtensions. 275Vac. Courant de décharge maximal 10KA (8/20us). Courant de fonctionnement maximal 5A. Adapté pour les connexions en séries. IP66.

Surge protection device. 275Vac. Maximum discharge current 10KA (8/20us). Maximum operating current 5A. Suitable for series connection. IP66.

F990E00A000

116,00 €

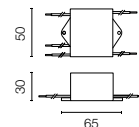

Fenestra 24V: Appareillages électriques / Drivers

Équipement d'alimentation 24V 8W / 110-240V IP20 Classe II selv.

Power supply 24V 8W / 110-240V IP20 Class II selv.

*RF25754

36,00 €

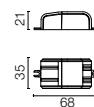

Équipement d'alimentation 24V 8W / 110-240V IP65 Classe II selv.

Power supply 24V 8W / 110-240V IP65 Class II selv.

*RF25748

63,00 €

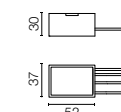

Équipement d'alimentation 24V 10W / 110-240V IP20 Classe II selv.

Power supply 24V 10W / 110-240V IP20 Class II selv.

*RF25747

48,00 €

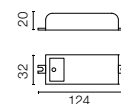

Équipement d'alimentation 24V 10W / 110-240V IP67 Classe II selv.

Power supply 24V 10W / 110-240V IP67 Class II selv.

*RF25757

86,00 €

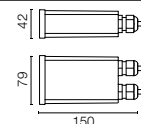

Alimentation 24Vdc 35W / 120-270V IP67 Class II selv.

Power supply 24Vdc 35W / 120-270V IP67 Class II selv.

*F990B23AZ00

180,00 €

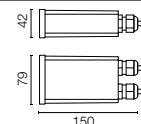

Équipement d'alimentation 24Vdc 50W / 120-240V IP67 Classe II selv.

Power supply 24Vdc 50W / 120-240V IP67 Class II selv.

*F990B28A000

251,00 €

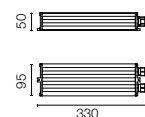

Équipement d'alimentation 24Vdc 70W / 220-240V IP67 Classe II selv.

Power supply 24Vdc 70W / 220-240V IP67 Class II selv.

*F990B27A000

212,00 €

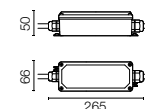

* Nombre maximum de luminaires par source d'alimentation / Maximum number of luminaires per power supply.

Nombre maximum de luminaires par source d'alimentation (220÷240 V). Ces données doivent être vérifiées en prenant en compte les conditions spécifiques d'installation.

Maximum number of luminaires per power supply. (220÷240 V). These data must be checked taking into account the specific installation conditions.

Acc. RF25754	1
Acc. RF25748	1
Acc. RF25747	2
Acc. RF25757	2
Acc. F990B23AZ00	6
Acc. F990B28A000	9
Acc. F990B27A000	13

A-Round

Designed by Piero Lissoni

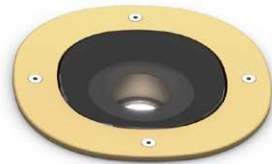





A-Round

Famille / Family

A-Round 315



Power Led

42W
3432 lm - 2700K/CRI 80
3978 lm - 3000K/CRI 80
4290 lm - 4000K/CRI 80

A-Round 240



Power Led

21W
1760 lm - 2700K/CRI 80
2040 lm - 3000K/CRI 80
2200 lm - 4000K/CRI 80

A-Round 150



Power Led

8W
572 lm - 2700K/CRI 80
663 lm - 3000K/CRI 80
715 lm - 4000K/CRI 80

Finitions / Colours



65 Matt Copper

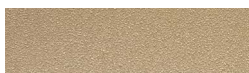

45 Matt Gold



48 Matt Bronze

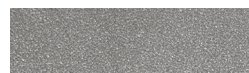

56 Matt Stainless Steel

Orientation sur l'axe vertical : max 15°
Adjustment on the vertical axis: max 15°

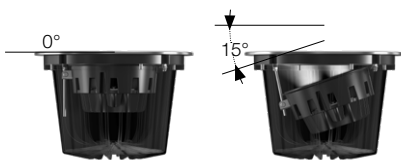

Rotation autour de l'axe horizontal : max 359°
Rotation around the horizontal axis: max 359°



Description / Description

Appareil encastré d'extérieur à LED disponible en trois dimensions, avec optique orientable et réglable en différentes configurations.

Anneau externe en acier inox AISI 316L traité par procédé PVD (Physical Vapour Deposition).

Grâce à ce traitement innovant, le matériau est recouvert d'un léger film de métal comme le zirconium et le titane qui, en se mélangeant à l'acier au niveau moléculaire, en augmentent sa résistance mécanique et contre les agents atmosphériques et permettent de réaliser des finitions précieuses et durables.

Corps de l'appareil en aluminium moulé sous pression EN AB-47100 à faible teneur en cuivre, recouvert d'une double couche de peinture à haute résistance anti-corrosion.

Verre transparent tempéré à haute résistance, sérigraphié pour réduire l'éblouissement.

Driver pour installation à distance inclus, fourni avec un connecteur rapide M12 étanche.

L'installation nécessite un boîtier à encastrer, à commander séparément.

Il est nécessaire de prévoir un niveau adéquat de gravier (> 300 mm) ou un système de drainage afin d'éviter la stagnation d'eau. Pour garantir la tenue du presse-étoupe, il convient d'utiliser des câbles électriques flexibles adaptés à une utilisation en extérieur.

Ground-recessed luminaire for outdoor use, walkable and trafficable, available in three sizes, with adjustable optics in various configurations.

External body made of stainless steel AISI 316L treated with the PVD process (Physical Vapour Deposition).

Thanks to this innovative treatment, the surfaces of A-Round are coated with a thin film of metals, such as zirconium and titanium which, combining with the steel at the molecular level, increases the resistance to both, mechanical and atmospheric agents, permitting the execution of elegant and durable finishings.

The body of the luminaire is made of die-cast aluminum EN AB-47100 with low copper content, coated with two layers of paint with high resistance to corrosion.

High-strength tempered clear glass, screen-printed to reduce glare.

Driver for remote installation included, provided with M12 quick connector for watertight coupling.

Installation requires a housing for flush mounting, to be ordered separately.

It is necessary to provide an adequate level of gravel (> 300 mm) or a drain system to ensure drainage and avoid water stagnation. To ensure the sealing of the cable gland it is necessary to use flexible electric cables suitable for use in outdoor environments.

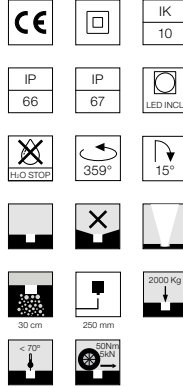
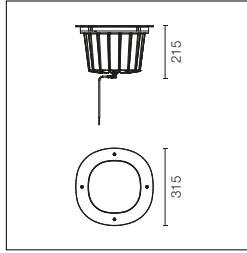

Alimentation 220/240V intégrée. Boîtier nécessaire, à commander séparément. Orientation sur l'axe vertical : max 15°. Rotation autour de l'axe horizontal : max 359°.

Integrated 220/240V power supply. Box for installation required, to be ordered separately. Adjustment on the vertical axis: max 15°. Rotation around the horizontal axis: max 359°.

Power Led: 42W - 3432 lm ≠ *FIXT 3203 lm - 2700K/CRI 80 - 220-240V / 42W - 3978 lm ≠ *FIXT 3447 lm - 3000K/CRI 80 - 220-240V / 42W - 4290 lm ≠ *FIXT 3707 lm - 4000K/CRI 80 - 220-240V
 *FIXT lm = Spot Optic

Optic Spot

2700K

Non Dimmable	
● F4588065.A	889,00 €
● F4588045.A	889,00 €
● F4588048.A	889,00 €
● F4588056.A	830,00 €
1-10V	
● F4588065-310.A	1.026,00 €
● F4588045-310.A	1.026,00 €
● F4588048-310.A	1.026,00 €
● F4588056-310.A	965,00 €
Dali	
● F4588065-300.A	1.069,00 €
● F4588045-300.A	1.069,00 €
● F4588048-300.A	1.069,00 €
● F4588056-300.A	1.009,00 €

3000K

Non Dimmable	
● F4591065.A	889,00 €
● F4591045.A	889,00 €
● F4591048.A	889,00 €
● F4591056.A	830,00 €
1-10V	
● F4591065-310.A	1.026,00 €
● F4591045-310.A	1.026,00 €
● F4591048-310.A	1.026,00 €
● F4591056-310.A	965,00 €
Dali	
● F4591065-300.A	1.069,00 €
● F4591045-300.A	1.069,00 €
● F4591048-300.A	1.069,00 €
● F4591056-300.A	1.009,00 €

4000K

Non Dimmable	
● F4594065.A	889,00 €
● F4594045.A	889,00 €
● F4594048.A	889,00 €
● F4594056.A	830,00 €
1-10V	
● F4594065-310.A	1.026,00 €
● F4594045-310.A	1.026,00 €
● F4594048-310.A	1.026,00 €
● F4594056-310.A	965,00 €
Dali	
● F4594065-300.A	1.069,00 €
● F4594045-300.A	1.069,00 €
● F4594048-300.A	1.069,00 €
● F4594056-300.A	1.009,00 €

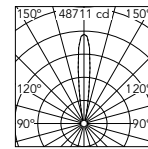

@4000K

Beam Angle: 14°			
h(m)	E(lx)	D(m)	
1	48711	0.25	
2	12178	0.49	
3	5412	0.74	
4	3044	0.98	
5	1948	1.23	

Optic Medium

2700K

Non Dimmable	
● F4589065.A	889,00 €
● F4589045.A	889,00 €
● F4589048.A	889,00 €
● F4589056.A	830,00 €
1-10V	
● F4589065-310.A	1.026,00 €
● F4589045-310.A	1.026,00 €
● F4589048-310.A	1.026,00 €
● F4589056-310.A	965,00 €
Dali	
● F4589065-300.A	1.069,00 €
● F4589045-300.A	1.069,00 €
● F4589048-300.A	1.069,00 €
● F4589056-300.A	1.009,00 €

3000K

Non Dimmable	
● F4592065.A	889,00 €
● F4592045.A	889,00 €
● F4592048.A	889,00 €
● F4592056.A	830,00 €
1-10V	
● F4592065-310.A	1.026,00 €
● F4592045-310.A	1.026,00 €
● F4592048-310.A	1.026,00 €
● F4592056-310.A	965,00 €
Dali	
● F4592065-300.A	1.069,00 €
● F4592045-300.A	1.069,00 €
● F4592048-300.A	1.069,00 €
● F4592056-300.A	1.009,00 €

4000K

Non Dimmable	
● F4595065.A	889,00 €
● F4595045.A	889,00 €
● F4595048.A	889,00 €
● F4595056.A	830,00 €
1-10V	
● F4595065-310.A	1.026,00 €
● F4595045-310.A	1.026,00 €
● F4595048-310.A	1.026,00 €
● F4595056-310.A	965,00 €
Dali	
● F4595065-300.A	1.069,00 €
● F4595045-300.A	1.069,00 €
● F4595048-300.A	1.069,00 €
● F4595056-300.A	1.009,00 €

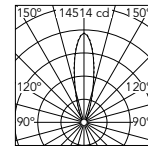

@4000K

Beam Angle: 25°			
h(m)	E(lx)	D(m)	
1	14514	0.43	
2	3629	0.86	
3	1613	1.29	
4	907	1.73	
5	581	2.16	

Optic Flood

2700K

Non Dimmable	
● F4590065.A	889,00 €
● F4590045.A	889,00 €
● F4590048.A	889,00 €
● F4590056.A	830,00 €
1-10V	
● F4590065-310.A	1.026,00 €
● F4590045-310.A	1.026,00 €
● F4590048-310.A	1.026,00 €
● F4590056-310.A	965,00 €
Dali	
● F4590065-300.A	1.069,00 €
● F4590045-300.A	1.069,00 €
● F4590048-300.A	1.069,00 €
● F4590056-300.A	1.009,00 €

3000K

Non Dimmable	
● F4593065.A	889,00 €
● F4593045.A	889,00 €
● F4593048.A	889,00 €
● F4593056.A	830,00 €
1-10V	
● F4593065-310.A	1.026,00 €
● F4593045-310.A	1.026,00 €
● F4593048-310.A	1.026,00 €
● F4593056-310.A	965,00 €
Dali	
● F4593065-300.A	1.069,00 €
● F4593045-300.A	1.069,00 €
● F4593048-300.A	1.069,00 €
● F4593056-300.A	1.009,00 €

4000K

Non Dimmable	
● F4596065.A	889,00 €
● F4596045.A	889,00 €
● F4596048.A	889,00 €
● F4596056.A	830,00 €
1-10V	
● F4596065-310.A	1.026,00 €
● F4596045-310.A	1.026,00 €
● F4596048-310.A	1.026,00 €
● F4596056-310.A	965,00 €
Dali	
● F4596065-300.A	1.069,00 €
● F4596045-300.A	1.069,00 €
● F4596048-300.A	1.069,00 €
● F4596056-300.A	1.009,00 €

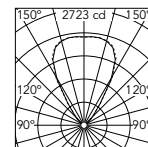

@4000K

Beam Angle: 64°			
h(m)	E(lx)	D(m)	
1	2723	1.23	
2	681	2.46	
3	303	3.69	
4	170	4.92	
5	109	6.15	

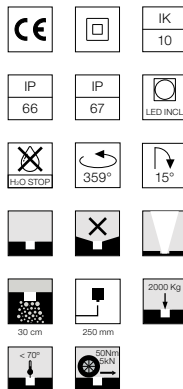
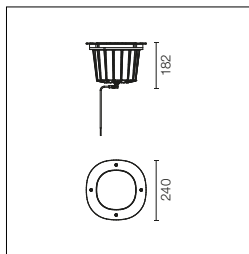

Alimentation 220/240V intégrée. Boîtier nécessaire, à commander séparément.
Orientation sur l'axe vertical : max 15°. Rotation autour de l'axe horizontal : max 359°.

Integrated 220/240V power supply. Box for installation required, to be ordered separately.
Adjustment on the vertical axis: max 15°. Rotation around the horizontal axis: max 359°.

Power Led: 21W - 1760 lm ≠ *FIXT 1623 lm - 2700K/CRI 80 - 220-240V / 21W - 2040 lm ≠ *FIXT 1747 lm - 3000K/CRI 80 - 220-240V / 21W - 2200 lm ≠ *FIXT 1878 lm - 4000K/CRI 80 - 220-240V
*FIXT lm = Spot Optic

Optic Spot

2700K

Non Dimmable	
● F4579065.A	709,00 €
● F4579045.A	709,00 €
● F4579048.A	709,00 €
● F4579056.A	674,00 €
1-10V	
● F4579065-310.A	876,00 €
● F4579045-310.A	876,00 €
● F4579048-310.A	876,00 €
● F4579056-310.A	840,00 €
DALI	
● F4579065-300.A	894,00 €
● F4579045-300.A	894,00 €
● F4579048-300.A	894,00 €
● F4579056-300.A	860,00 €

3000K

Non Dimmable	
● F4582065.A	709,00 €
● F4582045.A	709,00 €
● F4582048.A	709,00 €
● F4582056.A	674,00 €
1-10V	
● F4582065-310.A	876,00 €
● F4582045-310.A	876,00 €
● F4582048-310.A	876,00 €
● F4582056-310.A	840,00 €
DALI	
● F4582065-300.A	894,00 €
● F4582045-300.A	894,00 €
● F4582048-300.A	894,00 €
● F4582056-300.A	860,00 €

4000K

Non Dimmable	
● F4585065.A	709,00 €
● F4585045.A	709,00 €
● F4585048.A	709,00 €
● F4585056.A	674,00 €
1-10V	
● F4585065-310.A	876,00 €
● F4585045-310.A	876,00 €
● F4585048-310.A	876,00 €
● F4585056-310.A	840,00 €
DALI	
● F4585065-300.A	894,00 €
● F4585045-300.A	894,00 €
● F4585048-300.A	894,00 €
● F4585056-300.A	860,00 €

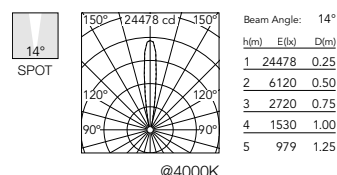

Optic Medium

2700K

Non Dimmable	
● F4580065.A	709,00 €
● F4580045.A	709,00 €
● F4580048.A	709,00 €
● F4580056.A	674,00 €
1-10V	
● F4580065-310.A	876,00 €
● F4580045-310.A	876,00 €
● F4580048-310.A	876,00 €
● F4580056-310.A	840,00 €
DALI	
● F4580065-300.A	894,00 €
● F4580045-300.A	894,00 €
● F4580048-300.A	894,00 €
● F4580056-300.A	860,00 €

3000K

Non Dimmable	
● F4583065.A	709,00 €
● F4583045.A	709,00 €
● F4583048.A	709,00 €
● F4583056.A	674,00 €
1-10V	
● F4583065-310.A	876,00 €
● F4583045-310.A	876,00 €
● F4583048-310.A	876,00 €
● F4583056-310.A	840,00 €
DALI	
● F4583065-300.A	894,00 €
● F4583045-300.A	894,00 €
● F4583048-300.A	894,00 €
● F4583056-300.A	860,00 €

4000K

Non Dimmable	
● F4586065.A	709,00 €
● F4586045.A	709,00 €
● F4586048.A	709,00 €
● F4586056.A	674,00 €
1-10V	
● F4586065-310.A	876,00 €
● F4586045-310.A	876,00 €
● F4586048-310.A	876,00 €
● F4586056-310.A	840,00 €
DALI	
● F4586065-300.A	894,00 €
● F4586045-300.A	894,00 €
● F4586048-300.A	894,00 €
● F4586056-300.A	860,00 €

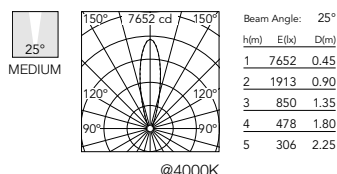

Optic Flood

2700K

Non Dimmable	
● F4581065.A	709,00 €
● F4581045.A	709,00 €
● F4581048.A	709,00 €
● F4581056.A	674,00 €
1-10V	
● F4581065-310.A	876,00 €
● F4581045-310.A	876,00 €
● F4581048-310.A	876,00 €
● F4581056-310.A	840,00 €
DALI	
● F4581065-300.A	894,00 €
● F4581045-300.A	894,00 €
● F4581048-300.A	894,00 €
● F4581056-300.A	860,00 €

3000K

Non Dimmable	
● F4584065.A	709,00 €
● F4584045.A	709,00 €
● F4584048.A	709,00 €
● F4584056.A	674,00 €
1-10V	
● F4584065-310.A	876,00 €
● F4584045-310.A	876,00 €
● F4584048-310.A	876,00 €
● F4584056-310.A	840,00 €
DALI	
● F4584065-300.A	894,00 €
● F4584045-300.A	894,00 €
● F4584048-300.A	894,00 €
● F4584056-300.A	860,00 €

4000K

Non Dimmable	
● F4587065.A	709,00 €
● F4587045.A	709,00 €
● F4587048.A	709,00 €
● F4587056.A	674,00 €
1-10V	
● F4587065-310.A	876,00 €
● F4587045-310.A	876,00 €
● F4587048-310.A	876,00 €
● F4587056-310.A	840,00 €
DALI	
● F4587065-300.A	894,00 €
● F4587045-300.A	894,00 €
● F4587048-300.A	894,00 €
● F4587056-300.A	860,00 €

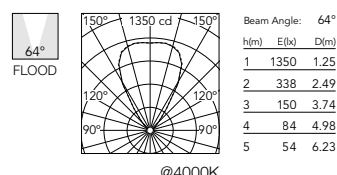

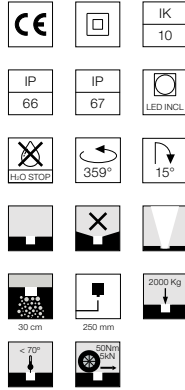
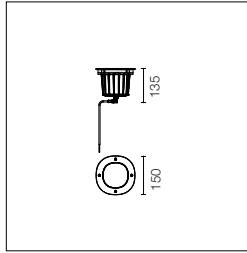

Alimentation 110/240V intégrée. Boîtier nécessaire, à commander séparément. Version dimmable sur demande. Orientation sur l'axe vertical : max 15°. Rotation autour de l'axe horizontal : max 359°.

Integrated 110/240V power supply. Box for installation required, to be ordered separately. Dimmable version on request. Adjustment on the vertical axis: max 15°. Rotation around the horizontal axis: max 359°.

Power Led: 8W - 572 lm ≠ *FIXT 536 lm - 2700K/CRI 80 - 110-240V / 8W - 663 lm ≠ *FIXT 576 lm - 3000K/CRI 80 - 110-240V / 8W - 715 lm ≠ *FIXT 620 lm - 4000K/CRI 80 - 110-240V
 *FIXT lm = Spot Optic

Optic Spot

2700K

● F4570065.A	458,00 €
● F4570045.A	458,00 €
● F4570048.A	458,00 €
● F4570056.A	421,00 €

3000K

● F4573065.A	458,00 €
● F4573045.A	458,00 €
● F4573048.A	458,00 €
● F4573056.A	421,00 €

4000K

● F4576065.A	458,00 €
● F4576045.A	458,00 €
● F4576048.A	458,00 €
● F4576056.A	421,00 €

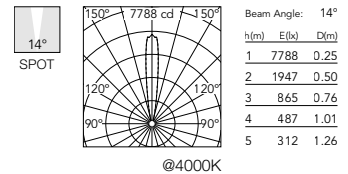

Optic Medium

2700K

● F4571065.A	458,00 €
● F4571045.A	458,00 €
● F4571048.A	458,00 €
● F4571056.A	421,00 €

3000K

● F4574065.A	458,00 €
● F4574045.A	458,00 €
● F4574048.A	458,00 €
● F4574056.A	421,00 €

4000K

● F4577065.A	458,00 €
● F4577045.A	458,00 €
● F4577048.A	458,00 €
● F4577056.A	421,00 €

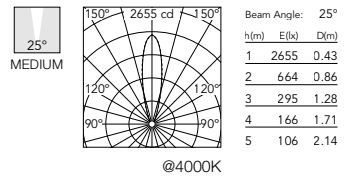

Optic Flood

2700K

● F4572065.A	458,00 €
● F4572045.A	458,00 €
● F4572048.A	458,00 €
● F4572056.A	421,00 €

3000K







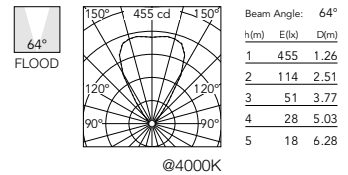





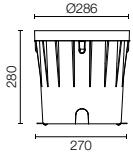

● F4575065.A	458,00 €
● F4575045.A	458,00 €
● F4575048.A	458,00 €
● F4575056.A	421,00 €

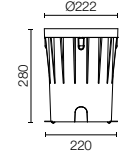
4000K

● F4578065.A	458,00 €
● F4578045.A	458,00 €
● F4578048.A	458,00 €
● F4578056.A	421,00 €

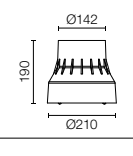

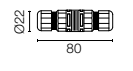
A-Round: Accessoires / Accessories

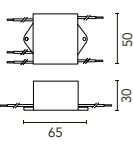
Honeycomb.	Honeycomb.	A-Round 315 - 4 Units Kit F4557000	75,00 €		
Lentille flood.	Flood lens.	A-Round 315 - 4 Units Kit F4560000	41,00 €		
Boitier.	Box for installation.	A-Round 315 F4599000	47,00 €		
Honeycomb.	Honeycomb.	A-Round 240 - 4 Units Kit F4556000	59,00 €		
Lentille flood.	Flood lens.	A-Round 240 - 4 Units Kit F4559000	30,00 €		
Boitier.	Box for installation.	A-Round 240 F4598000	47,00 €		
Honeycomb.	Honeycomb.	A-Round 150 - 4 Units Kit F4555000	23,00 €		
Lentille flood.	Flood lens.	A-Round 150 - 4 Units Kit F4558000	18,00 €		
Boitier.	Box for installation.	A-Round 150 F4597000	28,00 €		
Système de jonction IP68 H2O Stop anti-condensation à 2 voies 4 pôles. (Ø5,5÷12mm câble).	2 way terminal block 4 poles IP68 H2O Stop. (ø5,5÷12mm cable).	F990C00A000	33,00 €		
Système de jonction IP68 H2O Stop anti-condensation à 3/4 voies 4 pôles. (Ø5,5÷12mm câble).	3/4 way terminal block 4 poles IP68 H2O Stop. (ø5,5÷12mm cable).	F990C010000	60,00 €		
Dispositif de protection contre les surtensions. 275Vac. Courant de décharge maximal 10KA (8/20us). Courant de fonctionnement maximal 5A. Adapté pour les connexions en séries. IP66.	Surge protection device. 275Vac. Maximum discharge current 10KA (8/20us). Maximum operating current 5A. Suitable for series connection. IP66.	F990E00A000	116,00 €		

A-Rise



A-Rise

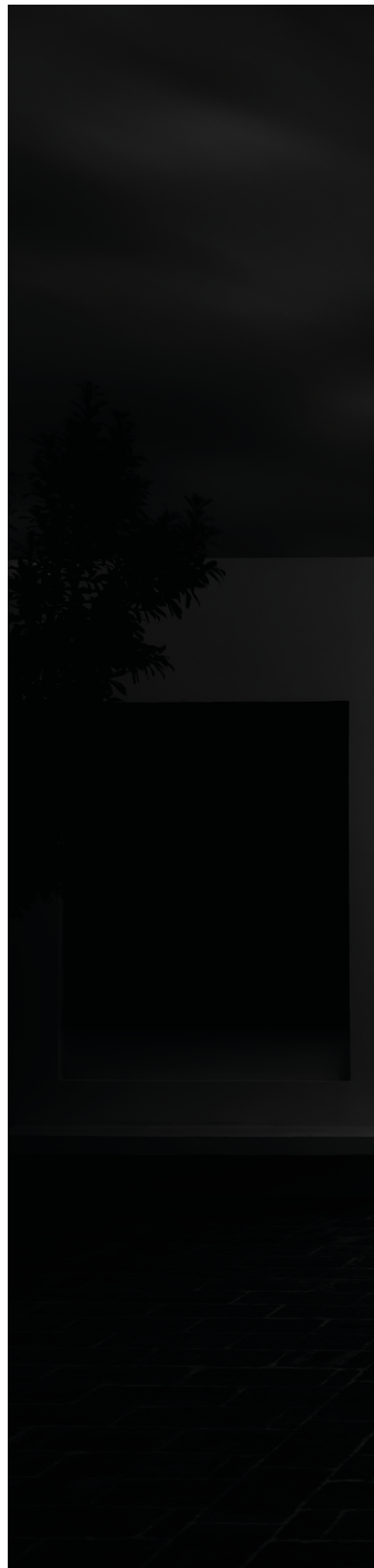



Famille / Family

A-Rise 290



Power Led

up to 39W
 up to 2956 lm - 2700K/CRI 80
 up to 3167 lm - 3000K/CRI 80
 up to 3273 lm - 4000K/CRI 80
 * Net lumen output

2200K available on request.

CoB Led

up to 38W
 up to 3093 lm - 2700K/CRI 80
 up to 3326 lm - 3000K/CRI 80
 up to 3411 lm - 4000K/CRI 80
 * Net lumen output

A-Rise 225



Power Led

up to 21W
 up to 1478 lm - 2700K/CRI 80
 up to 1584 lm - 3000K/CRI 80
 up to 1636 lm - 4000K/CRI 80
 * Net lumen output

2200K available on request.

CoB Led

up to 21W
 up to 1739 lm - 2700K/CRI 80
 up to 1870 lm - 3000K/CRI 80
 up to 1961 lm - 4000K/CRI 80
 * Net lumen output

A-Rise 145



Power Led

up to 8W
 up to 472 lm - 2700K/CRI 80
 up to 507 lm - 3000K/CRI 80
 up to 583 lm - 4000K/CRI 80
 * Net lumen output

CoB Led

up to 9W
 up to 545 lm - 2700K/CRI 80
 up to 586 lm - 3000K/CRI 80
 up to 610 lm - 4000K/CRI 80
 * Net lumen output

A-Rise 130



Mid - Power Led

up to 7W
 up to 453 lm - 3000K/CRI 80
 up to 479 lm - 4000K/CRI 80
 * Net lumen output

A-Rise 65



Power Led

up to 3,4W
 up to 138 lm - 2700K/CRI 80
 up to 149 lm - 3000K/CRI 80
 up to 155 lm - 4000K/CRI 80
 * Net lumen output

2200K available on request.

A-Rise 65 High Emission



Power Led

up to 4,5W
 up to 246 lm - 2700K/CRI 80
 up to 267 lm - 3000K/CRI 80
 up to 277 lm - 4000K/CRI 80
 * Net lumen output

2200K available on request.

A-Rise 49



Power Led

up to 2,3W
 up to 106 lm - 2700K/CRI 80
 up to 115 lm - 3000K/CRI 80
 up to 119 lm - 4000K/CRI 80
 * Net lumen output

2200K available on request.

Finitions / Colours

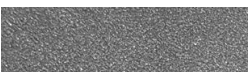

56 Matt Stainless Steel

Famille complète de luminaires avec source LED, encastrables au sol. Ils se caractérisent par ses lignes courbées qui s'adaptent aux différentes conditions d'installation architecturale. Disponibles en plusieurs tailles et avec différentes ouvertures du faisceau lumineux. Couvercles extérieurs en acier inoxydable 316L, soumis à un procédé de grenailage pour améliorer sa résistance à l'effort et son esthétique avec une touche légèrement satinée. Les vis de fixation sont en acier inoxydable AISI 316L. L'installation nécessite une boîte encastrable à commander séparément. Pour éviter la stagnation d'eau il est nécessaire d'isoler la partie inférieure de la boîte avec une couche de matériau drainant ou un autre système de drainage. Pour garantir le bon maintien de la gaine il est conseillé d'utiliser des câbles électriques flexibles et conçus pour l'extérieur.

A-Rise 145 / 225 / 290

Luminaire encastrable au sol et sur lequel on peut marcher. Disponible en trois diamètres et plusieurs ouvertures du faisceau lumineux. Viseur basculant sur l'axe vertical et ajustable sur l'axe horizontal pour régler la luminosité et l'adapter de manière parfaite à l'effet souhaité sur la surface. La position postérieure de la source lumineuse aide à réduire considérablement l'éblouissement direct, garantissant ainsi un confort visuel excellent. La structure et le dissipateur sont en aluminium moulé sous pression EN AB-47100 (à faible teneur en cuivre), revêtu d'une couche double de peinture hautement résistante à la corrosion. Le couvercle extérieur est en acier inoxydable AISI 316L soumis à un procédé de grenailage. Verre transparent tempéré pour une plus grande résistance, sérigraphié pour réduire l'éblouissement et fixé à l'anneau du couvercle extérieur avec un système d'encollage robotisé. Équipé d'un raccord fileté M12 étanche qui l'isole complètement des infiltrations d'eau et qui garantit une connexion rapide avec le câblage fourni, avec un kit IP66/67 distant à installer dans la boîte pour l'encastrement.

A-Rise 130

Luminaire encastrable au sol et sur lequel on peut marcher, qui se caractérise par un encastrement peu profond, ce qui permet de l'installer sur des murs de 80 mm. Ouverture large du faisceau lumineux pour une illumination douce et diffuse. Disponible avec deux facteurs de puissance et deux flux lumineux pour répondre aux différents besoins d'éclairage. Structure et dissipateur en aluminium moulé sous pression EN AB-47100 (à faible teneur en cuivre), couvert d'une double couche de peinture hautement résistante à la corrosion. Couvercle extérieur en acier inoxydable AISI 316L soumis à un procédé de grenailage. Diffuseur en verre dépoli, sérigraphié au centre pour réduire l'éblouissement et fixé par un système d'encollage robotisé. Disponible en version avec module LED à tension de ligne et en version 24V. Cette dernière version nécessite une source d'alimentation à distance à commander séparément.

A-Rise 49 / A-Rise 65

Version avec ressort du luminaire encastrable au sol et sur lequel on peut marcher, conçu pour être encastré au mur ou dans un faux plafond. Disponible en deux diamètres, il se caractérise par sa forme compacte et par l'absence de vis visibles. Disponible en différentes ouvertures du faisceau lumineux et de diffusion de la lumière. La position légèrement postérieure de la source lumineuse aide à réduire l'éblouissement direct. Structure en aluminium usiné par tournage, alliage EN AW 6060, anodisé pour une plus haute résistance à la corrosion. Couvercle extérieur en acier inoxydable 316L soumis à un procédé de grenailage. Diffuseur en polycarbonate transparent pour les versions avec faisceau étroit et moyen et en polycarbonate opale pour les versions à lumière diffuse. Luminaire en 24V dc, nécessite une source d'alimentation à distance à commander séparément.

Complete family of ground recessed luminaires with LED source. They are characterized by their curved lines, which adapt to different architectural installation conditions. Available in different sizes and different beam angles. External caps made of 316L stainless steel, shot-blasted to improve its resistance to stress and its aesthetics with a slightly satin finish. The fixing screws are made of AISI 316L stainless steel. The installation requires a recessed box to be ordered separately. To avoid water stagnation, it is necessary to insulate the lower part of the box with a layer of drainage material or other drainage system. In order to guarantee the preservation of the cable guide, it is recommended to use flexible electric cables specifically designed for outdoor use.

A-Rise 145 / 225 / 290

Ground recessed and walk-over luminaire. Available in three different diameters and different beam angles. Equipped with a visor that tilts on the vertical axis and that is adjustable on the horizontal axis in order to adjust brightness and to perfectly adapt it to the desired effect on the surface. The rear position of the light source contributes to a considerable reduction of direct glare, thus ensuring excellent visual comfort. The structure and sink are made of EN AB-47100 die-cast aluminum (with low copper content), coated with a double layer of highly corrosion-resistant paint. The external cap is made of AISI 316L shot-blasted stainless steel. Tempered, transparent glass for higher resistance, silkscreened in order to reduce glare. Fixed to the ring of the external cap through a robotic gluing system. Equipped with an M12 watertight screw-on connector which completely isolates it from water infiltration and guarantees a quick connection with the supplied wiring, together with a remote IP66/67 kit to be installed in the box for recessing.

A-Rise 130

Ground recessed and walk-over luminaire characterized by a shallow recessing which allows its installation in 80 mm partition walls. Wide beam angle for a smooth and diffused light. Available in two power factors and two luminous fluxes to meet different lighting requirements. EN AB-47100 die-cast aluminium structure and sink (with low copper content), coated with a double layer of highly corrosion-resistant paint. AISI 316L shot-blasted stainless steel external cap. Frosted glass diffuser, silkscreened at the center in order to reduce glare and fixed through a robotic gluing system. Available in two versions: 24V and line voltage LED module. The 24V version requires a remote power supply to be ordered separately.

A-Rise 49 / A-Rise 65

Spring-loaded version of the ground recessed and walk-over luminaire, designed to be recessed in walls or false ceilings. Available in two different diameters, it is characterized by its compact shape and the absence of visible screws. Available with different light diffusion and beam angles. The slightly rear position of the light source contributes to reduce the direct glare. Structure in turned aluminium, EN AW 6060 alloy, anodized for better resistance to corrosion. 316L shot-blasted stainless steel external cap. Transparent polycarbonate diffuser for narrow and medium beam versions and opal polycarbonate diffuser for diffused light versions. The 24V dc luminaire is powered by a remote power supply to be ordered separately.

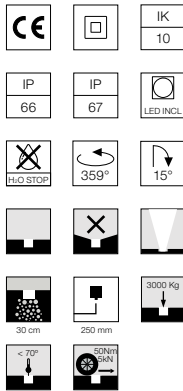
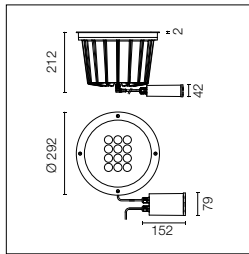

Source LED incluse. Source d'alimentation électrique à distance 24V dc ON/OFF intégrée. Orientation sur l'axe vertical : max. 15°. Orientation sur l'axe horizontal : max. 359°. Source d'alimentation à distance à loger dans une boîte de dérivation. Équipé d'un câble sortant de 400 mm avec un raccord fileté M12 qui garantit l'étanchéité du luminaire et d'un câble de 250 mm pour la connexion à la ligne électrique. Verre transparent extra-clair.

LED light source included. Integrated 24V dc ON/OFF remote electric power supply. Adjustment on vertical axis: 15° max. Rotation on horizontal axis: 359° max. Remote power supply that must be placed in a junction box, equipped with a protruding, 400 mm cable with an M12 screw-on connector that guarantees the water tightness of the luminaire, and with a 250 mm cable for the connection to the power line. Extra clear transparent glass.

2200K disponible sur demande.

2200K available on request.

Optic Spot 10°

Power Led: 39W - 3864 lm ≠ OUTPUT 2956 lm - 2700K/CRI 80 - 220÷240V / 39W - 4140 lm ≠ OUTPUT 3167 lm - 3000K/CRI 80 - 220÷240V / 39W - 4278 lm ≠ OUTPUT 3273 lm - 4000K/CRI 80 - 220÷240V

2700K

Non Dimmable

- FA53406356 728,00 €
- FA53406356-310 836,00 €
- FA53406356-300 855,00 €

3000K

Non Dimmable

- FA53403756 728,00 €
- FA53403756-310 836,00 €
- FA53403756-300 855,00 €

4000K

Non Dimmable

- FA53403656 728,00 €
- FA53403656-310 836,00 €
- FA53403656-300 855,00 €

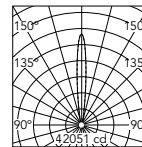

m	Max	Med
5,00	1682	1077
4,00	2128	1363
3,00	4672	2993
2,00	10513	6734
1,00	42051	26935

α = 5.6° + 5.6° β = 5.4° + 5.4°

@ 3000K

Optic Medium 35°

Power Led: 39W - 3864 lm ≠ OUTPUT 2722 lm - 2700K/CRI 80 - 220÷240V / 39W - 4140 lm ≠ OUTPUT 2917 lm - 3000K/CRI 80 - 220÷240V / 39W - 4278 lm ≠ OUTPUT 3014 lm - 4000K/CRI 80 - 220÷240V

2700K

Non Dimmable

- FA53406456 728,00 €
- FA53406456-310 836,00 €
- FA53406456-300 855,00 €

3000K

Non Dimmable

- FA53404056 728,00 €
- FA53404056-310 836,00 €
- FA53404056-300 855,00 €

4000K

Non Dimmable

- FA53403956 728,00 €
- FA53403956-310 836,00 €
- FA53403956-300 855,00 €

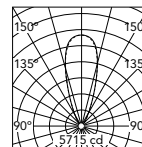

m	Max	Med
5,00	229	142
4,00	357	222
3,00	635	395
2,00	1429	889
1,00	5715	3558

α = 18.4° + 18.4° β = 18.5° + 18.5°

@ 3000K

Optic Flood 70°

Power Led: 39W - 3864 lm ≠ OUTPUT 2918 lm - 2700K/CRI 80 - 220÷240V / 39W - 4140 lm ≠ OUTPUT 3126 lm - 3000K/CRI 80 - 220÷240V / 39W - 4278 lm ≠ OUTPUT 3230 lm - 4000K/CRI 80 - 220÷240V

2700K

Non Dimmable

- FA53406556 728,00 €
- FA53406556-310 836,00 €
- FA53406556-300 855,00 €

3000K

Non Dimmable

- FA53404356 728,00 €
- FA53404356-310 836,00 €
- FA53404356-300 855,00 €

4000K

Non Dimmable

- FA53404256 728,00 €
- FA53404256-310 836,00 €
- FA53404256-300 855,00 €

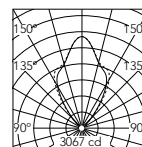

m	Max	Med
5,00	123	57
4,00	192	90
3,00	341	159
2,00	767	359
1,00	3067	1434

α = 31.0° + 31.0° β = 33.0° + 33.0°

@ 3000K

A-Rise 290 Wall Washer

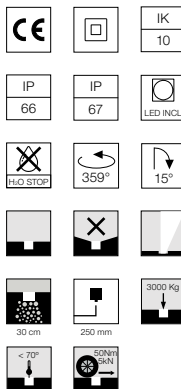
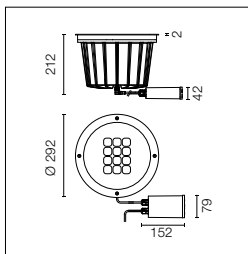

Source LED incluse. Source d'alimentation électrique à distance 24V dc ON/OFF intégrée. Orientation sur l'axe vertical : max. 15°. Orientation sur l'axe horizontal : max. 359°. Source d'alimentation à distance à loger dans une boîte de dérivation. Équipé d'un câble sortant de 400 mm avec un raccord fileté M12 qui garantit l'étanchéité du luminaire et d'un câble de 250 mm pour la connexion à la ligne électrique. Verre transparent extra-clair.

LED light source included. Integrated 24V dc ON/OFF remote electric power supply. Adjustment on vertical axis: 15° max. Rotation on horizontal axis: 359° max. Remote power supply that must be placed in a junction box, equipped with a protruding, 400 mm cable with an M12 screw-on connector that guarantees the water tightness of the luminaire, and with a 250 mm cable for the connection to the power line. Extra clear transparent glass.

2200K disponible sur demande.

2200K available on request.

Optic Asymmetric 54°x 66°

Power Led: 39W - 3864 lm ≠ OUTPUT 2840 lm - 2700K/CRI 80 - 220÷240V / 39W - 4140 lm ≠ OUTPUT 3043 lm - 3000K/CRI 80 - 220÷240V / 39W - 4278 lm ≠ OUTPUT 3144 lm - 4000K/CRI 80 - 220÷240V

2700K		3000K		4000K	
Non Dimmable		Non Dimmable		Non Dimmable	
● FA53406656	728,00 €	● FA53404656	728,00 €	● FA53404556	728,00 €
● FA53406656-310	836,00 €	● FA53404656-310	836,00 €	● FA53404556-310	836,00 €
● FA53406656-300	855,00 €	● FA53404656-300	855,00 €	● FA53404556-300	855,00 €

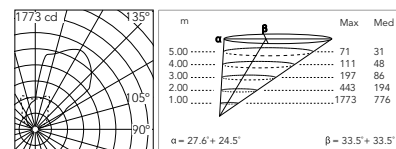

© 3000K

A-Rise 290 High Emission

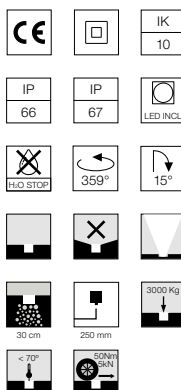
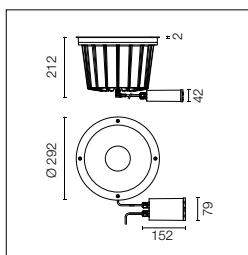

Source LED incluse. Source d'alimentation électrique à distance 24V dc ON/OFF intégrée. Orientation sur l'axe vertical : max. 15°. Orientation sur l'axe horizontal : max. 359°. Source d'alimentation à distance à loger dans une boîte de dérivation. Équipé d'un câble sortant de 400 mm avec un raccord fileté M12 qui garantit l'étanchéité du luminaire et d'un câble de 250 mm pour la connexion à la ligne électrique. Verre transparent extra-clair.

LED light source included. Integrated 24V dc ON/OFF remote electric power supply. Adjustment on vertical axis: 15° max. Rotation on horizontal axis: 359° max. Remote power supply that must be placed in a junction box, equipped with a protruding, 400 mm cable with an M12 screw-on connector that guarantees the water tightness of the luminaire, and with a 250 mm cable for the connection to the power line. Extra clear transparent glass.

Optic Medium 40°

CoB Led: 38W - 4078 lm ≠ OUTPUT 3093 lm - 2700K/CRI 80 - 220÷240V / 38W - 4385 lm ≠ OUTPUT 3326 lm - 3000K/CRI 80 - 220÷240V / 38W - 4496 lm ≠ OUTPUT 3411 lm - 4000K/CRI 80 - 220÷240V

2700K		3000K		4000K	
Non Dimmable		Non Dimmable		Non Dimmable	
● FA53406756	605,00 €	● FA53404856.A	605,00 €	● FA53404756	605,00 €
● FA53406756-310.A	716,00 €	● FA53404856-310.A	716,00 €	● FA53404756-310.A	716,00 €
● FA53406756-300	731,00 €	● FA53404856-300.A	731,00 €	● FA53404756-300	731,00 €

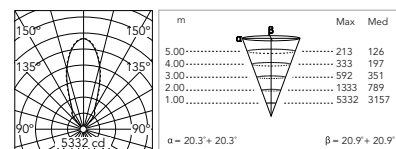

© 3000K

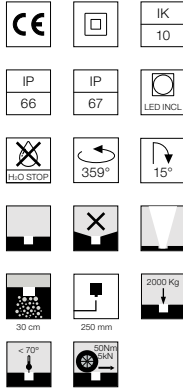
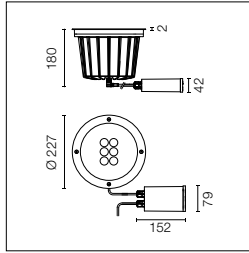

Source LED incluse. Source d'alimentation électrique à distance 24V dc ON/OFF intégrée. Orientation sur l'axe vertical : max. 15°. Orientation sur l'axe horizontal : max. 359°. Source d'alimentation à distance à loger dans une boîte de dérivation. Équipé d'un câble sortant de 400 mm avec un raccord fileté M12 qui garantit l'étanchéité du luminaire et d'un câble de 250 mm pour la connexion à la ligne électrique. Verre transparent extra-clair.

LED light source included. Integrated 24V dc ON/OFF remote electric power supply. Adjustment on vertical axis: 15° max. Rotation on horizontal axis: 359° max. Remote power supply that must be placed in a junction box, equipped with a protruding, 400 mm cable with an M12 screw-on connector that guarantees the water tightness of the luminaire, and with a 250 mm cable for the connection to the power line. Extra clear transparent glass.

2200K disponible sur demande.

2200K available on request.

Optic Spot 10°

Power Led: 21W - 1932 lm ≠ OUTPUT 1478 lm - 2700K/CRI 80 - 220÷240V / 21W - 2070 lm ≠ OUTPUT 1584 lm - 3000K/CRI 80 - 220÷240V / 21W - 2139 lm ≠ OUTPUT 1636 lm - 4000K/CRI 80 - 220÷240V

2700K

Non Dimmable

- FA53405756 584,00 €
- 1-10V
- FA53405756-310 623,00 €
- Dali
- FA53405756-300 682,00 €

3000K

Non Dimmable

- FA53402156 584,00 €
- 1-10V
- FA53402156-310 623,00 €
- Dali
- FA53402156-300 682,00 €

4000K

Non Dimmable

- FA53402056 584,00 €
- 1-10V
- FA53402056-310 623,00 €
- Dali
- FA53402056-300 682,00 €

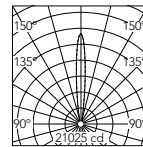

m	Max	Med
5,00	841	539
4,00	1314	842
3,00	2336	1496
2,00	5256	3367
1,00	21025	13468

α = 5.6° + 5.6° β = 5.4° + 5.4°

@ 3000K

Optic Medium 35°

Power Led: 21W - 1932 lm ≠ OUTPUT 1361 lm - 2700K/CRI 80 - 220÷240V / 21W - 2070 lm ≠ OUTPUT 1458 lm - 3000K/CRI 80 - 220÷240V / 21W - 2139 lm ≠ OUTPUT 1507 lm - 4000K/CRI 80 - 220÷240V

2700K

Non Dimmable

- FA53405856 584,00 €
- 1-10V
- FA53405856-310 623,00 €
- Dali
- FA53405856-300 682,00 €

3000K

Non Dimmable

- FA53402456 584,00 €
- 1-10V
- FA53402456-310 623,00 €
- Dali
- FA53402456-300 682,00 €

4000K

Non Dimmable

- FA53402356 584,00 €
- 1-10V
- FA53402356-310 623,00 €
- Dali
- FA53402356-300 682,00 €

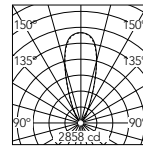

m	Max	Med
5,00	114	71
4,00	179	111
3,00	318	198
2,00	714	445
1,00	2838	1779

α = 18.4° + 18.4° β = 18.5° + 18.5°

@ 3000K

Optic Flood 70°

Power Led: 21W - 1932 lm ≠ OUTPUT 1459 lm - 2700K/CRI 80 - 220÷240V / 21W - 2070 lm ≠ OUTPUT 1563 lm - 3000K/CRI 80 - 220÷240V / 21W - 2139 lm ≠ OUTPUT 1615 lm - 4000K/CRI 80 - 220÷240V

2700K

Non Dimmable

- FA53405956 584,00 €
- 1-10V
- FA53405956-310 623,00 €
- Dali
- FA53405956-300 682,00 €

3000K

Non Dimmable

- FA53402756 584,00 €
- 1-10V
- FA53402756-310 623,00 €
- Dali
- FA53402756-300 682,00 €

4000K

Non Dimmable

- FA53402656 584,00 €
- 1-10V
- FA53402656-310 623,00 €
- Dali
- FA53402656-300 682,00 €

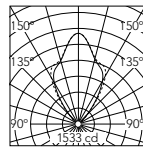

m	Max	Med
5,00	61	29
4,00	96	45
3,00	170	80
2,00	383	179
1,00	1533	717

α = 31.0° + 31.0° β = 33.0° + 33.0°

@ 3000K

A-Rise 225 Wall Washer

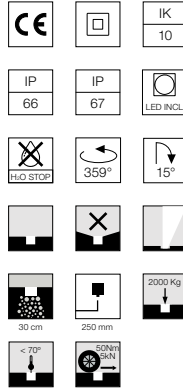
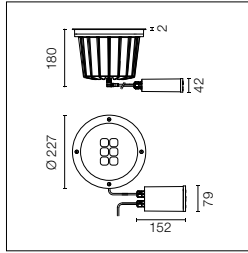

Source LED incluse. Source d'alimentation électrique à distance 24V dc ON/OFF intégrée. Orientation sur l'axe vertical : max. 15°. Orientation sur l'axe horizontal : max. 359°. Source d'alimentation à distance à loger dans une boîte de dérivation. Équipé d'un câble sortant de 400 mm avec un raccord fileté M12 qui garantit l'étanchéité du luminaire et d'un câble de 250 mm pour la connexion à la ligne électrique. Verre transparent extra-clair.

LED light source included. Integrated 24V dc ON/OFF remote electric power supply. Adjustment on vertical axis: 15° max. Rotation on horizontal axis: 359° max. Remote power supply that must be placed in a junction box, equipped with a protruding, 400 mm cable with an M12 screw-on connector that guarantees the water tightness of the luminaire, and with a 250 mm cable for the connection to the power line. Extra clear transparent glass.

2200K disponible sur demande.

2200K available on request.

Optic Asymmetric 54°x 66°

Power Led: 21W - 1932 lm ≠ OUTPUT 1420 lm - 2700K/CRI 80 - 220÷240V / 21W - 2070 lm ≠ OUTPUT 1521 lm - 3000K/CRI 80 - 220÷240V / 21W - 2139 lm ≠ OUTPUT 1572 lm - 4000K/CRI 80 - 220÷240V

2700K		3000K		4000K	
Non Dimmable		Non Dimmable		Non Dimmable	
● FA53406056	584,00 €	● FA53403056	584,00 €	● FA53402956	584,00 €
1-10V		1-10V		1-10V	
● FA53406056-310	623,00 €	● FA53403056-310	623,00 €	● FA53402956-310	623,00 €
Dali		Dali		Dali	
● FA53406056-300	682,00 €	● FA53403056-300	682,00 €	● FA53402956-300	682,00 €

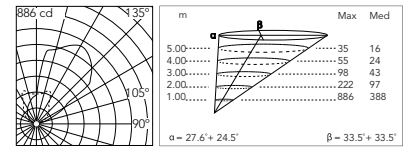

@ 3000K

A-Rise 225 High Emission

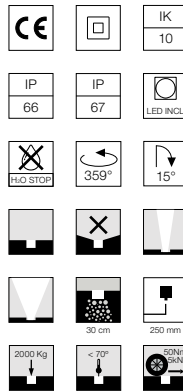
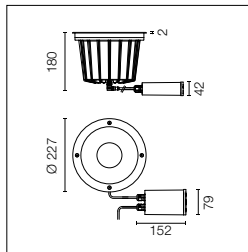

Source LED incluse. Source d'alimentation électrique à distance 24V dc ON/OFF intégrée. Orientation sur l'axe vertical : max. 15°. Orientation sur l'axe horizontal : max. 359°. Source d'alimentation à distance à loger dans une boîte de dérivation. Équipé d'un câble sortant de 400 mm avec un raccord fileté M12 qui garantit l'étanchéité du luminaire et d'un câble de 250 mm pour la connexion à la ligne électrique. Verre transparent extra-clair.

LED light source included. Integrated 24V dc ON/OFF remote electric power supply. Adjustment on vertical axis: 15° max. Rotation on horizontal axis: 359° max. Remote power supply that must be placed in a junction box, equipped with a protruding, 400 mm cable with an M12 screw-on connector that guarantees the water tightness of the luminaire, and with a 250 mm cable for the connection to the power line. Extra clear transparent glass.

Optic Spot 16°

CoB Led: 21W - 2246 lm ≠ OUTPUT 1739 lm - 2700K/CRI 80 - 220÷240V / 21W - 2415 lm ≠ OUTPUT 1870 lm - 3000K/CRI 80 - 220÷240V / 21W - 2533 lm ≠ OUTPUT 1961 lm - 4000K/CRI 80 - 220÷240V

2700K		3000K		4000K	
Non Dimmable		Non Dimmable		Non Dimmable	
● FA53406156.A	533,00 €	● FA53403256	533,00 €	● FA53403156.A	533,00 €
1-10V		1-10V		1-10V	
● FA53406156-310.A	621,00 €	● FA53403256-310	621,00 €	● FA53403156-310.A	621,00 €
Dali		Dali		Dali	
● FA53406156-300.B	639,00 €	● FA53403256-300.A	639,00 €	● FA53403156-300.B	639,00 €

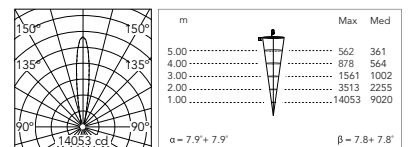

@ 3000K

Optic Medium 40°

CoB Led: 21W - 2246 lm ≠ OUTPUT 1673 lm - 2700K/CRI 80 - 220÷240V / 21W - 2415 lm ≠ OUTPUT 1799 lm - 3000K/CRI 80 - 220÷240V / 21W - 2533 lm ≠ OUTPUT 1886 lm - 4000K/CRI 80 - 220÷240V

2700K		3000K		4000K	
Non Dimmable		Non Dimmable		Non Dimmable	
● FA53406256.A	533,00 €	● FA53403456	533,00 €	● FA53403356.A	533,00 €
1-10V		1-10V		1-10V	
● FA53406256-310.A	621,00 €	● FA53403456-310	621,00 €	● FA53403356-310.A	621,00 €
Dali		Dali		Dali	
● FA53406256-300.B	639,00 €	● FA53403456-300.A	639,00 €	● FA53403356-300.B	639,00 €

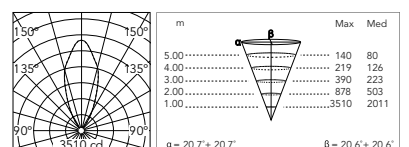

@ 3000K

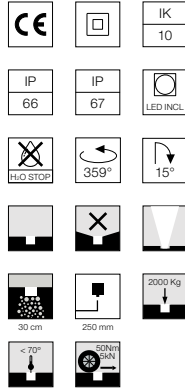
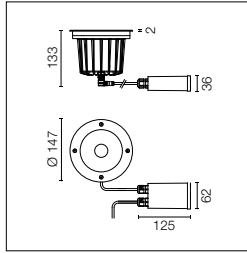

Source LED incluse. Source d'alimentation électrique à distance 24V dc ON/OFF intégrée. Orientation sur l'axe vertical : max. 15°. Orientation sur l'axe horizontal : max. 359°. Source d'alimentation à distance à loger dans une boîte de dérivation. Équipé d'un câble sortant de 400 mm avec un raccord fileté M12 qui garantit l'étanchéité du luminaire et d'un câble de 250 mm pour la connexion à la ligne électrique. Verre transparent extra-clair. Version avec intensité réglable disponible sur demande.

LED light source included. Integrated 24V dc ON/OFF remote electric power supply. Adjustment on vertical axis: 15° max. Rotation on horizontal axis: 359° max. Remote power supply that must be placed in a junction box, equipped with a protruding, 400 mm cable with an M12 screw-on connector that guarantees the water tightness of the luminaire, and with a 250 mm cable for the connection to the power line. Extra clear transparent glass. Adjustable light intensity version available upon request.

Optic Spot 10°

Power Led: 8W - 509 lm ≠ OUTPUT 451 lm - 2700K/CRI 80 - 220÷240V / 8W - 547 lm ≠ OUTPUT 485 lm - 3000K/CRI 80 - 220÷240V / 8W - 630 lm ≠ OUTPUT 558 lm - 4000K/CRI 80 - 220÷240V

2700K

● FA53405156.A 366,00 €

3000K

● FA53400356.A 366,00 €

4000K

● FA53400256.A 366,00 €

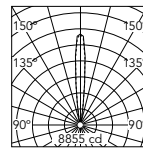

m	Max	Med
5,00	354	237
4,00	553	370
3,00	764	457
2,00	2,214	1479
1,00	8,855	5916

α = 5.7° + 5.7° β = 5.6° + 5.6°

@ 3000K

Optic Medium 24°

Power Led: 8W - 509 lm ≠ OUTPUT 472 lm - 2700K/CRI 80 - 220÷240V / 8W - 547 lm ≠ OUTPUT 507 lm - 3000K/CRI 80 - 220÷240V / 8W - 630 lm ≠ OUTPUT 583 lm - 4000K/CRI 80 - 220÷240V

2700K

● FA53405256.A 366,00 €

3000K

● FA53400656.A 366,00 €

4000K

● FA53400556.A 366,00 €

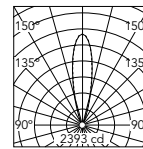

m	Max	Med
5,00	96	61
4,00	150	95
3,00	236	169
2,00	598	399
1,00	2,393	1517

α = 12.0° + 12.0° β = 11.7° + 11.7°

@ 3000K

Optic Flood 50°

Power Led: 8W - 509 lm ≠ OUTPUT 433 lm - 2700K/CRI 80 - 220÷240V / 8W - 547 lm ≠ OUTPUT 466 lm - 3000K/CRI 80 - 220÷240V / 8W - 630 lm ≠ OUTPUT 536 lm - 4000K/CRI 80 - 220÷240V

2700K

● FA53405356.A 366,00 €

3000K

● FA53400956.A 366,00 €

4000K

● FA53400856.A 366,00 €

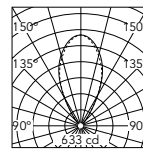

m	Max	Med
5,00	25	14
4,00	40	21
3,00	70	38
2,00	158	85
1,00	633	338

α = 26.2° + 26.2° β = 25.8° + 25.8°

@ 3000K

A-Rise 145 Wall Washer

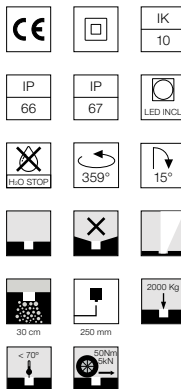
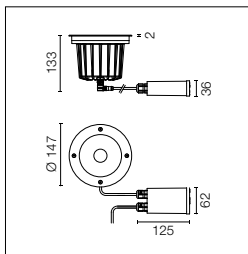

Source LED incluse. Source d'alimentation électrique à distance 24V dc ON/OFF intégrée. Orientation sur l'axe vertical : max. 15°. Orientation sur l'axe horizontal : max. 359°. Source d'alimentation à distance à loger dans une boîte de dérivation. Équipé d'un câble sortant de 400 mm avec un raccord fileté M12 qui garantit l'étanchéité du luminaire et d'un câble de 250 mm pour la connexion à la ligne électrique. Verre transparent extra-clair. Version avec intensité réglable disponible sur demande.

LED light source included. Integrated 24V dc ON/OFF remote electric power supply. Adjustment on vertical axis: 15° max. Rotation on horizontal axis: 359° max. Remote power supply that must be placed in a junction box, equipped with a protruding, 400 mm cable with an M12 screw-on connector that guarantees the water tightness of the luminaire, and with a 250 mm cable for the connection to the power line. Extra clear transparent glass. Adjustable light intensity version available upon request.

Optic Asymmetric 54°x 66°

Power Led: 8W - 509 lm ≠ OUTPUT 413 lm - 2700K/CRI 80 - 220÷240V / 8W - 547 lm ≠ OUTPUT 444 lm - 3000K/CRI 80 - 220÷240V / 8W - 630 lm ≠ OUTPUT 511 lm - 4000K/CRI 80 - 220÷240V

- 2700K**
 ● FA53405456.A 366,00 €
- 3000K**
 ● FA53401256.A 366,00 €
- 4000K**
 ● FA53401156.A 366,00 €

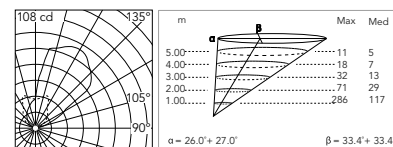

@ 3000K

A-Rise 145 High Emission

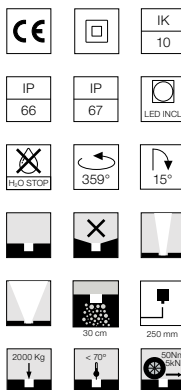
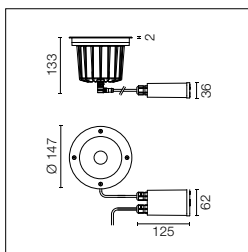

Source LED incluse. Source d'alimentation électrique à distance 24V dc ON/OFF intégrée. Orientation sur l'axe vertical : max. 15°. Orientation sur l'axe horizontal : max. 359°. Source d'alimentation à distance à loger dans une boîte de dérivation. Équipé d'un câble sortant de 400 mm avec un raccord fileté M12 qui garantit l'étanchéité du luminaire et d'un câble de 250 mm pour la connexion à la ligne électrique. Verre transparent extra-clair. Version avec intensité réglable disponible sur demande.

LED light source included. Integrated 24V dc ON/OFF remote electric power supply. Adjustment on vertical axis: 15° max. Rotation on horizontal axis: 359° max. Remote power supply that must be placed in a junction box, equipped with a protruding, 400 mm cable with an M12 screw-on connector that guarantees the water tightness of the luminaire, and with a 250 mm cable for the connection to the power line. Extra clear transparent glass. Adjustable light intensity version available upon request.

Optic Spot 16°

CoB Led: 9W - 857 lm ≠ OUTPUT 518 lm - 2700K/CRI 80 - 220÷240V / 9W - 922 lm ≠ OUTPUT 557 lm - 3000K/CRI 80 - 220÷240V / 9W - 959 lm ≠ OUTPUT 579 lm - 4000K/CRI 80 - 220÷240V

- 2700K**
 ● FA53405556 333,00 €
- 3000K**
 ● FA53401556 333,00 €
- 4000K**
 ● FA53401456 333,00 €

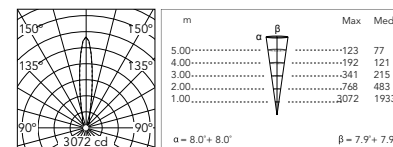

@ 3000K

Optic Flood 50°





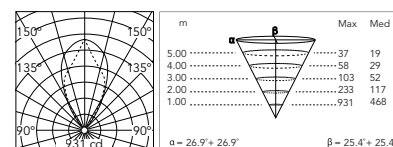



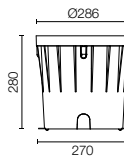

CoB Led: 9W - 857 lm ≠ OUTPUT 545 lm - 2700K/CRI 80 - 220÷240V / 9W - 922 lm ≠ OUTPUT 586 lm - 3000K/CRI 80 - 220÷240V / 9W - 959 lm ≠ OUTPUT 610 lm - 4000K/CRI 80 - 220÷240V

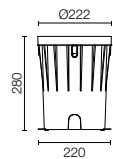
- 2700K**
 ● FA53405656 333,00 €
- 3000K**
 ● FA53401856 333,00 €
- 4000K**
 ● FA53401756 333,00 €

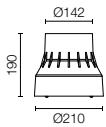

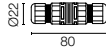
@ 3000K

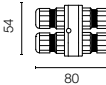
A-Rise: Accessoires / Accessories

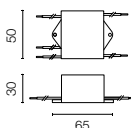
Boitier.	Box for installation.	A-Rise 290 F4599000	47,00 €		
Boitier.	Box for installation.	A-Rise 225 F4598000	47,00 €		
Boitier.	Box for installation.	A-Rise 145 F4597000	28,00 €		
Système de jonction IP68 H ₂ O Stop anti-condensation à 2 voies 4 pôles. (ø5,5÷12mm câble).	2 way terminal block 4 poles IP68 H ₂ O Stop. (ø5,5÷12mm câble).	F990C00A000	33,00 €		
Système de jonction IP68 H ₂ O Stop anti-condensation à 3/4 voies 4 pôles. (ø5,5÷12mm câble).	3/4 way terminal block 4 poles IP68 H ₂ O Stop. (ø5,5÷12mm câble).	F990C010000	60,00 €		
Dispositif de protection contre les surtensions. 275Vac. Courant de décharge maximal 10KA (8/20µs). Courant de fonctionnement maximal 5A. Adapté pour les connexions en séries. IP66.	Surge protection device. 275Vac. Maximum discharge current 10KA (8/20µs). Maximum operating current 5A. Suitable for series connection. IP66.	F990E00A000	116,00 €		

A-Rise 130 HP

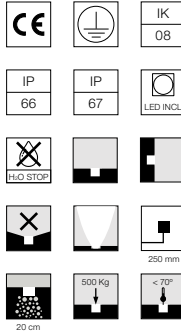
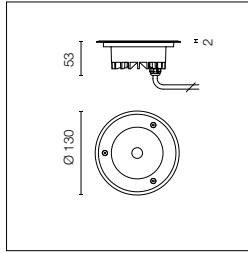

Source LED incluse à tension secteur. Boîte de dérivation nécessaire, à commander séparément. Équipé d'un câble sortant de 250 mm en néoprène, avec un système de connexion intégré H2O STOP à 2 voies et 3 pôles qui garantit l'étanchéité de la connexion. Verre dépoli.

Mains voltage LED light source included. Requires a junction box to be ordered separately. The luminaire is equipped with a protruding, neoprene, 250 mm cable with an integrated 2-way, 3-pole H2O STOP connection system guaranteeing the water tightness of the connection. Frosted glass.

Optic Wide Flood 96°

Mid-Power Led: 7W - 525 lm ≠ OUTPUT 453 lm - 3000K/CRI 80 - 220-230V / 7W - 555 lm ≠ OUTPUT 479 lm - 4000K/CRI 80 - 220-230V

3000K

● FA53000356.A 227,00 €

4000K

● FA53000256.A 227,00 €

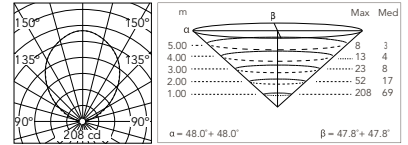

@ 4000K

A-Rise 130

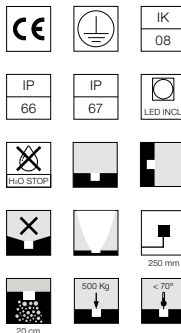
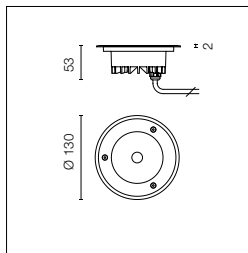

Source LED incluse à tension secteur. Boîte de dérivation nécessaire, à commander séparément. Équipé d'un câble sortant de 250 mm en néoprène, avec un système de connexion intégré H2O STOP à 2 voies et 3 pôles qui garantit l'étanchéité de la connexion. Verre dépoli.

Mains voltage LED light source included. Requires a junction box to be ordered separately. The luminaire is equipped with a protruding, neoprene, 250 mm cable with an integrated 2-way, 3-pole H2O STOP connection system guaranteeing the water tightness of the connection. Frosted glass.

Optic Wide Flood 120°

Mid-Power Led: 4W - 380 lm ≠ OUTPUT 189 lm - 3000K/CRI 80 - 220.230V / 4W - 400 lm ≠ OUTPUT 199 lm - 4000K/CRI 80 - 220.230V

3000K

● FA53000856.A 227,00 €

4000K

● FA53000756.A 227,00 €

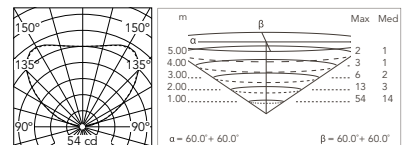

@ 4000K

A-Rise 130: Accessoires / Accessories

Boîtier.	Box for installation.	FA50	11,00 €		
Système de jonction IP68 H2O Stop anti-condensation à 3/4 voies 4 pôles. (Ø5,5÷12mm câble).	3/4 way terminal block 4 poles IP68 H2O Stop. (ø5,5÷12mm cable).	F990C010000	60,00 €		
Dispositif de protection contre les surtensions. 275Vac. Courant de décharge maximal 10KA (8/20us). Courant de fonctionnement maximal 5A. Adapté pour les connexions en série. IP66.	Surge protection device. 275Vac. Maximum discharge current 10KA (8/20us). Maximum operating current 5A. Suitable for series connection. IP66.	F990E00A000	116,00 €		

A-Rise 130 HP Low Voltage

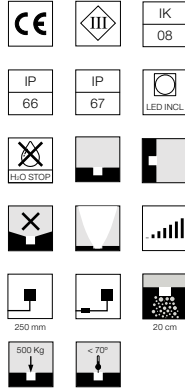
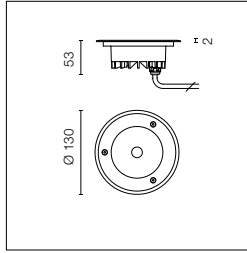

Source LED incluse. Source d'alimentation électrique à distance 24V, à commander séparément, ON/OFF et avec intensité réglable entre 1 et 10V ou DALI. Boîte de dérivation nécessaire, à commander séparément. Équipé d'un câble sortant de 250 mm en néoprène, avec un système de connexion intégré H2O STOP et d'un kit avec des connecteurs sertissables et des gaines thermorétractables adhésives qui garantissent l'étanchéité de la connexion. Verre dépoli.

LED light source included. 24V remote electric power supply to be ordered separately, ON/OFF and adjustable light intensity from 1 to 10V or DALI. Requires a junction box to be ordered separately. The luminaire is equipped with a protruding, neoprene, 250 mm cable with an integrated H2O STOP connection system and a wiring kit with crimp connectors and adhesive heat-shrink tubing guaranteeing the water tightness of the connection. Frosted glass.

Optic Wide Flood 96°

Mid-Power Led: 7,3W - 707 lm ≠ OUTPUT 380 lm - 3000K/CRI 80 - 24Vdc / 7,3W - 734 lm ≠ OUTPUT 394 lm - 4000K/CRI 80 - 24Vdc

3000K

Dimmable

● FA53000656 214,00 €

4000K

Dimmable

● FA53000556 214,00 €

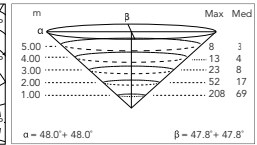
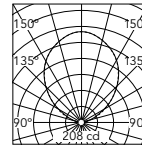

@ 4000K

* Nombre maximum de luminaires par source d'alimentation / Max fixtures for each power supply

Nombre maximum de luminaires par source d'alimentation (220-240 V). Ces données doivent être vérifiées en prenant en compte les conditions spécifiques d'installation.

Max fixtures for each power supply (Vin 220-240). Data in the chart are provided as a guide only. Please verify according to your installation.

Acc. RF25747	1	Acc. RF25752	2
Acc. RF25757	1	Acc. F990B28A000	7
Acc. RF25750	2	Acc. F990B27A000	9
Acc. F990B21A000	2	Acc. F990B29A000	12
Acc. RF26387.A	2		

A-Rise 130 Low Voltage

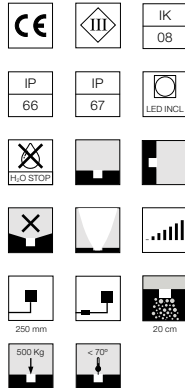
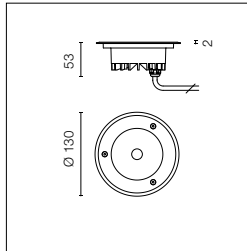

Source LED incluse. Source d'alimentation électrique à distance 24V, à commander séparément, ON/OFF et avec intensité réglable entre 1 et 10V ou DALI. Boîte de dérivation nécessaire, à commander séparément. Équipé d'un câble sortant de 250 mm en néoprène, avec un système de connexion intégré H2O STOP et d'un kit avec des connecteurs sertissables et des gaines thermorétractables adhésives qui garantissent l'étanchéité de la connexion. Verre dépoli.

LED light source included. 24V remote electric power supply to be ordered separately, ON/OFF and adjustable light intensity from 1 to 10V or DALI. Requires a junction box to be ordered separately. The luminaire is equipped with a protruding, neoprene, 250 mm cable with an integrated H2O STOP connection system and a wiring kit with crimp connectors and adhesive heat-shrink tubing guaranteeing the water tightness of the connection. Frosted glass.

Optic Wide Flood 120°

Mid-Power Led: 4W - 360 lm ≠ OUTPUT 190 lm - 3000K/CRI 80 - 24Vdc / 4W - 380 lm ≠ OUTPUT 200 lm - 4000K/CRI 80 - 24Vdc

3000K

Dimmable

● FA530001056 214,00 €

4000K

Dimmable

● FA53000956 214,00 €

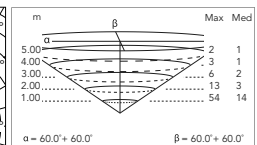
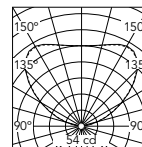

@ 4000K



* Nombre maximum de luminaires par source d'alimentation / Max fixtures for each power supply

Nombre maximum de luminaires par source d'alimentation (220-240 V). Ces données doivent être vérifiées en prenant en compte les conditions spécifiques d'installation.





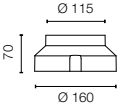

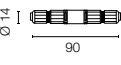



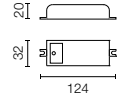

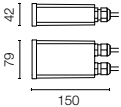

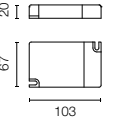

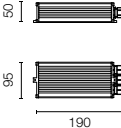

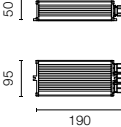
Max fixtures for each power supply (Vin 220-240). Data in the chart are provided as a guide only. Please verify according to your installation.

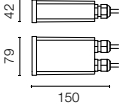
Acc. RF25747	2	Acc. RF25752	4
Acc. RF25757	2	Acc. F990B28A000	12
Acc. RF25750	4	Acc. F990B27A000	16
Acc. F990B21A000	4	Acc. F990B29A000	21
Acc. RF26387.A	4		

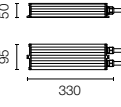
A-Rise 130 Low Voltage: Accessoires / Accessories

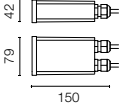
Boitier.	Box for installation.	FA50	11,00 €		
Système de jonction IP68 à 2 voies 2 pôles. (Ø4÷6,9mm câble). Il ne peut pas être placé dans le boîtier encastré pour l'installation.	2 way terminal block 2 poles IP68. (Ø4÷6,9mm cable). It can't be placed in the recessed box for installation.	F990C050000	34,00 €		

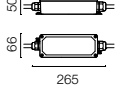
A-Rise 130 Low Voltage: Appareillages électriques / Drivers

Équipement d'alimentation 24V 10W / 110-240V IP20 Classe II selv.	Power supply 24V 10W / 110-240V IP20 Class II selv.	*RF25747	48,00 €		
Équipement d'alimentation 24V 10W / 110-240V IP67 Classe II selv.	Power supply 24V 10W / 110-240V IP67 Class II selv.	*RF25757	86,00 €		
Équipement d'alimentation pour installation à distance 24Vdc 17W / 110-240V (15W@110V) IP20 Classe II selv.	Power supply for remote installation 24Vdc 17W / 110-240V (15W@110V) IP20 Class II selv.	*RF25750  Dimmable Push-Dim Or 1-10V See Wiring Diagram n.4. page 830.	96,00 €		
Équipement d'alimentation 17W/110÷240V - 24Vdc (15W@110V) IP67 Classe II selv.	Power supply 17W/110÷240V - 24Vdc (15W@110V) IP67 Class II Selv.	*F990B21A000  Dimmable Push-Dim Or 1-10V See Wiring Diagram n.4. page 830.	159,00 €		
Équipement d'alimentation pour installation à distance 24Vdc 20W / 110-240Vdc (15W@110V) IP67 Classe II selv.	Power supply for remote installation 24Vdc 20W / 110-240Vdc (15W@110V) IP67 Class II selv.	*RF26387.A  Dimmable DALI See Wiring Diagram n.4. page 830.	159,00 €		
Équipement d'alimentation pour installation à distance 24Vdc 20W / 220-240V IP67 Classe II selv.	Power supply for remote installation 24Vdc 20W / 220-240V IP67 Class II selv.	*RF25752	133,00 €		
Équipement d'alimentation pour installation à distance 24Vdc 50W / 120-240V IP67 Classe II selv.	Power supply for remote installation 24Vdc 50W / 120-240V IP67 Class II selv.	*F990B28A000	251,00 €		
Alimentation 24Vdc 35W / 120-270V IP67 Classe II selv.	Power supply 24Vdc 35W / 120-270V IP67 Class II selv.	F990B23AZ00	180,00 €		
Équipement d'alimentation pour installation à distance 24Vdc 70W / 220-240V IP67 Classe II selv.	Power supply for remote installation 24Vdc 70W / 220-240V IP67 Class II selv.	*F990B27A000	212,00 €		
Équipement d'alimentation pour installation à distance 24Vdc 96W / 120-240V IP67 Classe II selv.	Power supply for remote installation 24Vdc 96W / 120-240V IP67 Class II selv.	*F990B29A000	300,00 €		

A-Rise 65 Ceiling

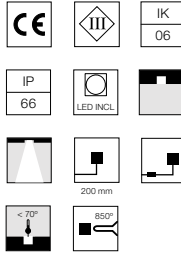
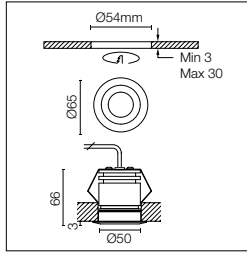

Source LED incluse. Source d'alimentation électrique à distance 24V dc à commander séparément. Complété par un ressort pour une installation en placoplâtre. Équipé d'un câble sortant de 200 mm en néoprène, et d'un kit avec des connecteurs sertissables et des gaines thermorétractables adhésives qui garantissent l'étanchéité de la connexion. Diffuseur en polycarbonate transparent. Version avec intensité réglable disponible sur demande.

LED source included. 24V dc remote electric power supply to be ordered separately. Includes a spring for plasterboard installations. The luminaire is equipped with a protruding, neoprene, 200 mm cable and a wiring kit with crimp connectors and adhesive heat-shrink tubing guaranteeing the water tightness of the connection. Transparent polycarbonate diffuser. Adjustable light intensity version available upon request.

2200K disponible sur demande.

2200K available on request.

Optic Spot 10°

Power Led: 3,4W - 199 lm ≠ OUTPUT 138 lm - 2700K/CRI 80 - 24Vdc / 3,4W - 215 lm ≠ OUTPUT 149 lm - 3000K/CRI 80 - 24Vdc / 3,4W - 224 lm ≠ OUTPUT 155 lm - 4000K/CRI 80 - 24Vdc

2700K

● FA51820556 199,00 €

3000K

● FA51800656 199,00 €

4000K

● FA51800556 199,00 €

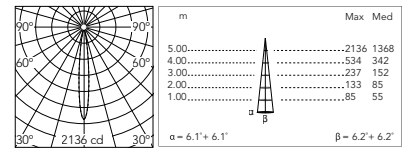

@ 3000K

Optic Medium 30°

Power Led: 3,4W - 199 lm ≠ OUTPUT 121 lm - 2700K/CRI 80 - 24Vdc / 3,4W - 215 lm ≠ OUTPUT 131 lm - 3000K/CRI 80 - 24Vdc / 3,4W - 224 lm ≠ OUTPUT 136 lm - 4000K/CRI 80 - 24Vdc

2700K

● FA51820856 199,00 €

3000K

● FA51800956 199,00 €

4000K

● FA51800856 199,00 €

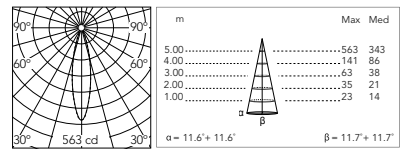

@ 3000K

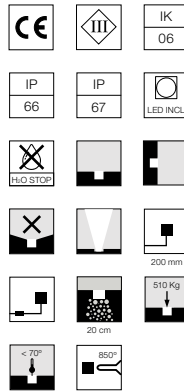
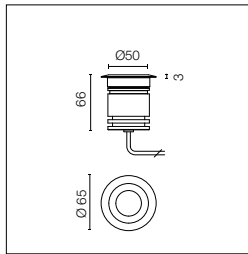

Source LED incluse. Source d'alimentation électrique à distance 24V dc à commander séparément. Boîte de dérivation nécessaire, à commander séparément. Équipé d'un câble sortant de 200 mm en néoprène, avec un système de connexion intégré H2O STOP et d'un kit avec des connecteurs sertissables et des gaines thermorétractables adhésives qui garantissent l'étanchéité de la connexion. Diffuseur en polycarbonate transparent. Version avec intensité réglable sur demande.

LED source included. 24V dc remote electric power supply to be ordered separately. Requires a junction box to be ordered separately. The luminaire is equipped with a protruding, neoprene, 200 mm cable with an integrated H2O STOP connection system and a wiring kit with crimp connectors and adhesive heat-shrink tubing guaranteeing the water tightness of the connection. Transparent polycarbonate diffuser. Adjustable light intensity version available upon request.

2200K disponible sur demande.

2200K available on request.

Optic Spot 10°

Power Led: 3,4W - 199 lm ≠ OUTPUT 138 lm - 2700K/CRI 80 - 24Vdc / 3,4W - 215 lm ≠ OUTPUT 149 lm - 3000K/CRI 80 - 24Vdc / 3,4W - 224 lm ≠ OUTPUT 155 lm - 4000K/CRI 80 - 24Vdc

- 2700K**
● FA51820256 178,00 €
- 3000K**
● FA51800356 178,00 €
- 4000K**
● FA51800256 178,00 €

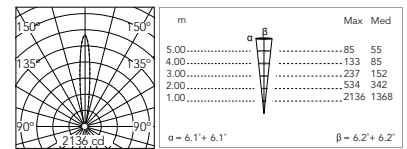

@ 3000K

Optic Medium 30°

Power Led: 3,4W - 199 lm ≠ OUTPUT 121 lm - 2700K/CRI 80 - 24Vdc / 3,4W - 215 lm ≠ OUTPUT 131 lm - 3000K/CRI 80 - 24Vdc / 3,4W - 224 lm ≠ OUTPUT 136 lm - 4000K/CRI 80 - 24Vdc

- 2700K**
● FA51821256 178,00 €
- 3000K**
● FA51801356 178,00 €
- 4000K**
● FA51801256 178,00 €

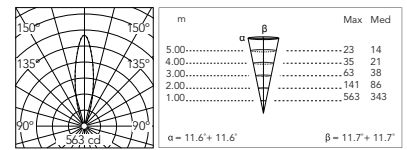

@ 3000K

A-Rise 65 Opal

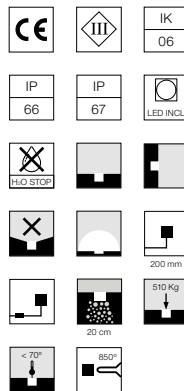
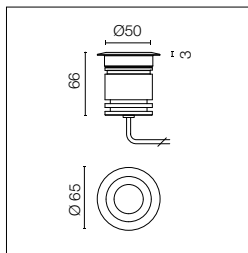

Source LED incluse. Source d'alimentation électrique à distance 24V dc à commander séparément. Boîte de dérivation nécessaire, à commander séparément. Équipé d'un câble sortant de 200 mm en néoprène, et d'un kit avec des connecteurs sertissables et des gaines thermorétractables adhésives qui garantissent l'étanchéité de la connexion. Diffuseur en polycarbonate opale. Version avec intensité réglable sur demande.

LED light source included. 24V dc remote electric power supply to be ordered separately. Requires a junction box to be ordered separately. The luminaire is equipped with a protruding, neoprene, 200 mm cable and a wiring kit with crimp connectors and adhesive heat-shrink tubing guaranteeing the water tightness of the connection. Opal polycarbonate diffuser. Adjustable light intensity version available upon request.

2200K disponible sur demande.

2200K available on request.

Optic Wide Flood 100°

Power Led: 3,4W - 169 lm ≠ OUTPUT 20 lm - 2700K/CRI 80 - 24Vdc / 3,4W - 182 lm ≠ OUTPUT 22 lm - 3000K/CRI 80 - 24Vdc / 3,4W - 198 lm ≠ OUTPUT 24 lm - 4000K/CRI 80 - 24Vdc

- 2700K**
● FA51823456 178,00 €
- 3000K**
● FA51803556 178,00 €
- 4000K**
● FA51803456 178,00 €

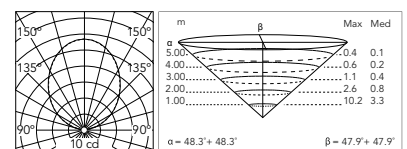

@ 4000K

A-Rise 65 HP Ceiling

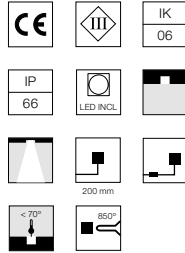
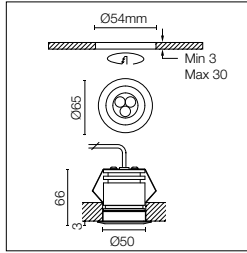

Source LED incluse. Source d'alimentation électrique à distance 24V dc à commander séparément. Complété par un ressort pour une installation en placoplâtre. Équipé d'un câble sortant de 200 mm en néoprène, et d'un kit avec des connecteurs sertissables et des gaines thermorétractables adhésives qui garantissent l'étanchéité de la connexion. Diffuseur en polycarbonate transparent. Version avec intensité réglable disponible sur demande.

LED source included. 24V dc remote electric power supply to be ordered separately. Includes a spring for plasterboard installations. The luminaire is equipped with a protruding, neoprene, 200 mm cable and a wiring kit with crimp connectors and adhesive heat-shrink tubing guaranteeing the water tightness of the connection. Transparent polycarbonate diffuser. Adjustable light intensity version available upon request.

2200K disponible sur demande.

2200K available on request.

Optic Spot 10°

Power Led: 4,5W - 331 lm ≠ OUTPUT 246 lm - 2700K/CRI 80 - 24Vdc / 4,5W - 359 lm ≠ OUTPUT 267 lm - 3000K/CRI 80 - 24Vdc / 4,5W - 373 lm ≠ OUTPUT 277 lm - 4000K/CRI 80 - 24Vdc

2700K

● FA51821556 199,00 €

3000K

● FA51801656 199,00 €

4000K

● FA51801556 199,00 €

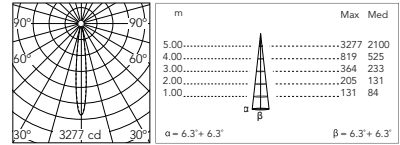

@ 3000K

Optic Medium 30°

Power Led: 4,5W - 331 lm ≠ OUTPUT 218 lm - 2700K/CRI 80 - 24Vdc / 4,5W - 359 lm ≠ OUTPUT 236 lm - 3000K/CRI 80 - 24Vdc / 4,5W - 373 lm ≠ OUTPUT 245 lm - 4000K/CRI 80 - 24Vdc

2700K

● FA51822556 199,00 €

3000K

● FA51802656 199,00 €

4000K

● FA51802556 199,00 €

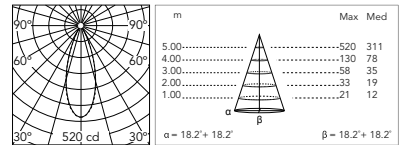

@ 3000K

A-Rise 65 HP

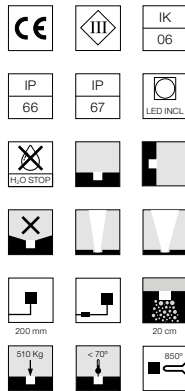
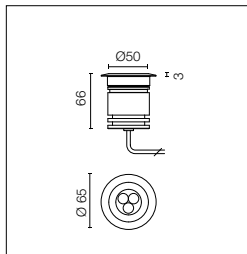

Source LED incluse. Source d'alimentation électrique à distance 24V dc à commander séparément. Boîte de dérivation nécessaire, à commander séparément. Équipé d'un câble sortant de 200 mm en néoprène, avec un système de connexion intégré H2O STOP et d'un kit avec des connecteurs sertissables et des gaines thermorétractables adhésives qui garantissent l'étanchéité de la connexion. Diffuseur en polycarbonate transparent. Version avec intensité réglable sur demande.

LED source included. 24V dc remote electric power supply to be ordered separately. Requires a junction box to be ordered separately. The luminaire is equipped with a protruding, neoprene, 200 mm cable with an integrated H2O STOP connection system and a wiring kit with crimp connectors and adhesive heat-shrink tubing guaranteeing the water tightness of the connection. Transparent polycarbonate diffuser. Adjustable light intensity version available upon request.

2200K disponible sur demande.

2200K available on request.

Optic Spot 10°

Power Led: 4,5W - 331 lm ≠ OUTPUT 246 lm - 2700K/CRI 80 - 24Vdc / 4,5W - 359 lm ≠ OUTPUT 267 lm - 3000K/CRI 80 - 24Vdc / 4,5W - 373 lm ≠ OUTPUT 277 lm - 4000K/CRI 80 - 24Vdc

2700K

● FA51822256 199,00 €

3000K

● FA51802356 199,00 €

4000K

● FA51802256 199,00 €

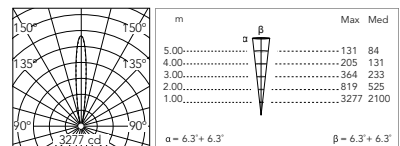

@ 3000K

Optic Medium 30°

Power Led: 4,5W - 331 lm ≠ OUTPUT 218 lm - 2700K/CRI 80 - 24Vdc / 4,5W - 359 lm ≠ OUTPUT 236 lm - 3000K/CRI 80 - 24Vdc / 4,5W - 373 lm ≠ OUTPUT 245 lm - 4000K/CRI 80 - 24Vdc

2700K

● FA51823256 199,00 €

3000K

● FA51803356 199,00 €

4000K

● FA51803256 199,00 €

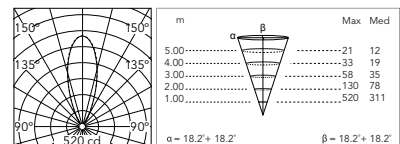









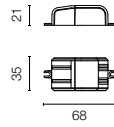

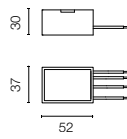

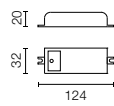
@ 3000K

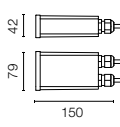
A-Rise 65: Accessoires / Accessories

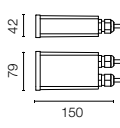
Boitier.	Box for installation.	F004Z0K0000	10,00 €		
Système de jonction IP68 à 2 voies 2 pôles. (Ø4÷6,9mm câble). Il ne peut pas être placé dans le boîtier encastré pour l'installation.	2 way terminal block 2 poles IP68. (Ø4÷6,9mm cable). It can't be placed in the recessed box for installation.	F990C050000	34,00 €		

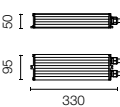
A-Rise 65: Appareillages électriques 24Vdc / Drivers 24Vdc

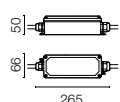
Source d'alimentation avec fonction dual Vout 24Vdc : 8W/100÷240V lout 350ma: 6x1W/100÷240V IP20 Classe II Selv Eq.	Power supply dual function Vout 24Vdc: 8W/100÷240V lout 350ma: 6x1W/100÷240V IP20 Class II Selv Eq.	*RF25754	36,00 €		
Équipement d'alimentation 24V 8W / 110-240V IP65 Classe II selv.	Power supply 24V 8W / 110-240V IP65 Class II selv.	*RF25748	63,00 €		
Équipement d'alimentation pour installation à distance 24Vdc 10W / 110-240V IP20 Classe II selv.	Power supply for remote installation 24Vdc 10W / 110-240V IP20 Class II selv.	*RF25747	48,00 €		
Équipement d'alimentation 24V 10W / 110-240V IP67 Classe II selv.	Power supply 24V 10W / 110-240V IP67 Class II selv.	*RF25757	86,00 €		
Alimentation 24Vdc 35W / 120-270V IP67 Class II selv.	Power supply 24Vdc 35W / 120-270V IP67 Class II selv.	F990B23AZ00	180,00 €		
Équipement d'alimentation pour installation à distance 24Vdc 50W / 120-240V IP67 Classe II selv.	Power supply for remote installation 24Vdc 50W / 120-240V IP67 Class II selv.	*F990B28A000	251,00 €		
Équipement d'alimentation pour installation à distance 24Vdc 70W / 220-240V IP67 Classe II selv.	Power supply for remote installation 24Vdc 70W / 220-240V IP67 Class II selv.	*F990B27A000	212,00 €		

* Nombre maximum de luminaires par source d'alimentation / Max fixtures for each power supply

Nombre maximum de luminaires par source d'alimentation (220÷240 V). Ces données doivent être vérifiées en prenant en compte les conditions spécifiques d'installation.

Max fixtures for each power supply (Vin 220÷240). Data in the chart are provided as a guide only. Please verify according to your installation.

A-RISE 65		A-RISE 65 HP	
Acc. RF25754	1	Acc. RF25754	1
Acc. RF25748	1	Acc. RF25748	1
Acc. RF25747	2	Acc. RF25747	2
Acc. RF25757	2	Acc. RF25757	2
Acc. F990B28A000	9	Acc. F990B28A000	7
Acc. F990B27A000	17	Acc. F990B27A000	14

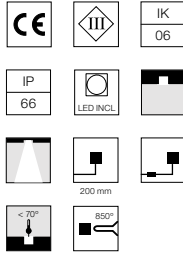
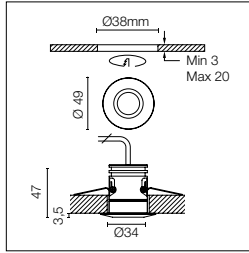

Source LED incluse. Source d'alimentation électrique à distance 24V dc à commander séparément. Complété par un ressort pour une installation en placoplâtre. Équipé d'un câble sortant de 200 mm en néoprène, et d'un kit avec des connecteurs sertissables et des gaines thermorétractables adhésives qui garantissent l'étanchéité de la connexion. Diffuseur en polycarbonate transparent. Version avec intensité réglable disponible sur demande.

LED source included. 24V dc remote electric power supply to be ordered separately. Includes a spring for plasterboard installations. The luminaire is equipped with a protruding, neoprene, 200 mm cable and a wiring kit with crimp connectors and adhesive heat-shrink tubing guaranteeing the water tightness of the connection. Transparent polycarbonate diffuser. Adjustable light intensity version available upon request.

2200K disponible sur demande.

2200K available on request.

Optic Spot 15°

Power Led: 2,3W - 144 lm ≠ OUTPUT 106 lm - 2700K/CRI 80 - 12÷24Vdc / 2,3W - 155 lm ≠ OUTPUT 115 lm - 3000K/CRI 80 - 12÷24Vdc / 2,3W - 161 lm ≠ OUTPUT 119 lm - 4000K/CRI 80 - 12÷24Vdc

2700K

● FA51711556 140,00 €

3000K

● FA51711356 140,00 €

4000K

● FA51711256 140,00 €

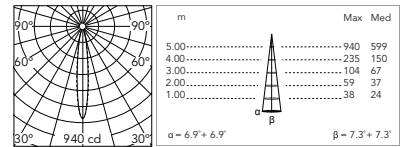

@ 3000K

Optic Medium 45°

Power Led: 2,3W - 144 lm ≠ OUTPUT 97 lm - 2700K/CRI 80 - 12÷24Vdc / 2,3W - 155 lm ≠ OUTPUT 105 lm - 3000K/CRI 80 - 12÷24Vdc / 2,3W - 161 lm ≠ OUTPUT 109 lm - 4000K/CRI 80 - 12÷24Vdc

2700K

● FA51712556 140,00 €

3000K

● FA51712356 140,00 €

4000K

● FA51712256 140,00 €

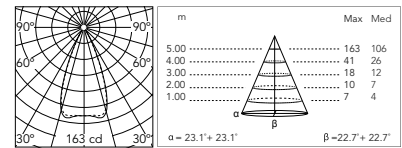

@ 3000K

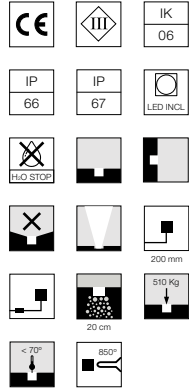
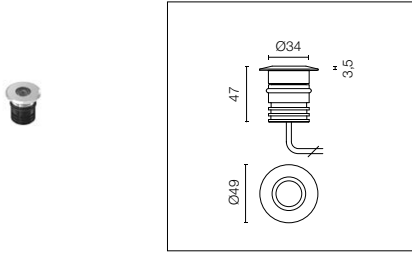

Source LED incluse. Source d'alimentation électrique à distance 24V dc à commander séparément. Boîte de dérivation nécessaire, à commander séparément. Équipé d'un câble sortant de 200 mm en néoprène, avec un système de connexion intégré H2O STOP et d'un kit avec des connecteurs sertissables et des gaines thermorétractables adhésives qui garantissent l'étanchéité de la connexion. Diffuseur en polycarbonate transparent. Version avec intensité réglable sur demande.

LED source included. 24V dc remote electric power supply to be ordered separately. Requires a junction box to be ordered separately. The luminaire is equipped with a protruding, neoprene, 200 mm cable with an integrated H2O STOP connection system and a wiring kit with crimp connectors and adhesive heat-shrink tubing guaranteeing the water tightness of the connection. Transparent polycarbonate diffuser. Adjustable light intensity version available upon request.

2200K disponible sur demande.

2200K available on request.

Optic Spot 15°

Power Led: 2,3W - 144 lm ≠ OUTPUT 106 lm - 2700K/CRI 80 - 12÷24Vdc / 2,3W - 155 lm ≠ OUTPUT 115 lm - 3000K/CRI 80 - 12÷24Vdc / 2,3W - 161 lm ≠ OUTPUT 119 lm - 4000K/CRI 80 - 12÷24Vdc

- 2700K**
● FA51700556 123,00 €
- 3000K**
● FA51700356 123,00 €
- 4000K**
● FA51700256 123,00 €

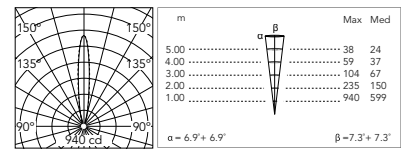

@ 3000K

Optic Medium 45°

Power Led: 2,3W - 144 lm ≠ OUTPUT 97 lm - 2700K/CRI 80 - 12÷24Vdc / 2,3W - 155 lm ≠ OUTPUT 105 lm - 3000K/CRI 80 - 12÷24Vdc / 2,3W - 161 lm ≠ OUTPUT 109 lm - 4000K/CRI 80 - 12÷24Vdc

- 2700K**
● FA51701656 123,00 €
- 3000K**
● FA51701356 123,00 €
- 4000K**
● FA51701256 123,00 €

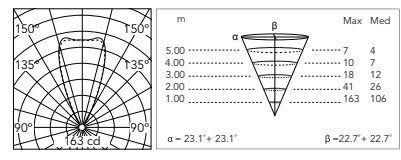

@ 3000K

A-Rise 49 Opal

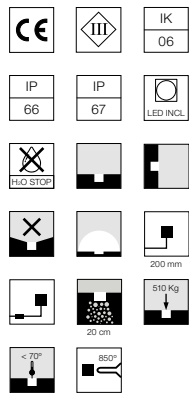
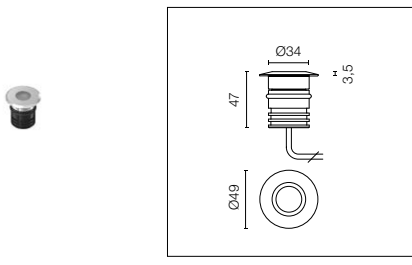

Source LED incluse. Source d'alimentation électrique à distance 24V dc à commander séparément. Boîte de dérivation nécessaire, à commander séparément. Équipé d'un câble sortant de 200 mm en néoprène, et d'un kit avec des connecteurs sertissables et des gaines thermorétractables adhésives qui garantissent l'étanchéité de la connexion. Diffuseur en polycarbonate opale. Version avec intensité réglable sur demande.

LED light source included. 24V dc remote electric power supply to be ordered separately. Requires a junction box to be ordered separately. The luminaire is equipped with a protruding, neoprene, 200 mm cable and a wiring kit with crimp connectors and adhesive heat-shrink tubing guaranteeing the water tightness of the connection. Opal polycarbonate diffuser. Adjustable light intensity version available upon request.

2200K disponible sur demande.

2200K available on request.

Optic Wide Flood 100°

Power Led: 2,3W - 139 lm ≠ OUTPUT 16 lm - 2700K/CRI 80 - 12÷24Vdc / 2,3W - 149 lm ≠ OUTPUT 17 lm - 3000K/CRI 80 - 12÷24Vdc / 2,3W - 162 lm ≠ OUTPUT 18 lm - 4000K/CRI 80 - 12÷24Vdc

- 2700K**
● FA51701756 123,00 €
- 3000K**
● FA51701556 123,00 €
- 4000K**
● FA51701456 123,00 €

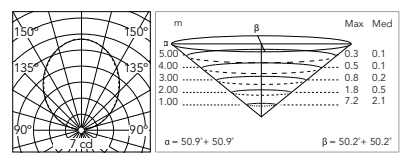

@ 4000K

A-Rise 49: Accessoires / Accessories

Boîtier.	Box for installation.	F004Z0J0000	10,00 €		
Système de jonction IP68 à 2 voies 2 pôles. (Ø4÷6,9mm câble). Il ne peut pas être placé dans le boîtier encastré pour l'installation.	2 way terminal block 2 poles IP68. (Ø4÷6,9mm cable). It can't be placed in the recessed box for installation.	F990C050000	34,00 €		

A-Rise 49: Appareillages électriques / Drivers

Source d'alimentation avec fonction dual Vout 24Vdc : 8W/100÷240V Iout 350ma: 6x1W/100÷240V IP20 Classe II Selv Eq.	Power supply dual function Vout 24Vdc: 8W/100÷240V Iout 350ma: 6x1W/100÷240V IP20 Class II Selv Eq.	*RF25754	36,00 €		
Équipement d'alimentation 24V 8W / 110-240V IP65 Classe II selv.	Power supply 24V 8W / 110-240V IP65 Class II selv.	*RF25748	63,00 €		
Équipement d'alimentation pour installation à distance 24Vdc 10W / 110-240V IP20 Classe II selv.	Power supply for remote installation 24Vdc 10W / 110-240V IP20 Class II selv.	*RF25747	48,00 €		
Équipement d'alimentation 24V 10W / 110-240V IP67 Classe II selv.	Power supply 24V 10W / 110-240V IP67 Class II selv.	*RF25757	86,00 €		
Équipement d'alimentation pour installation à distance 24Vdc 20W / 220-240V IP67 Classe II selv.	Power supply for remote installation 24Vdc 20W / 220-240V IP67 Class II selv.	*RF25752	133,00 €		
Alimentation 24Vdc 35W / 120-270V IP67 Class II selv.	Power supply 24Vdc 35W / 120-270V IP67 Class II selv.	F990B23AZ00	180,00 €		
Équipement d'alimentation pour installation à distance 24Vdc 50W / 120-240V IP67 Classe II selv.	Power supply for remote installation 24Vdc 50W / 120-240V IP67 Class II selv.	*F990B28A000	251,00 €		
Équipement d'alimentation pour installation à distance 24Vdc 70W / 220-240V IP67 Classe II selv.	Power supply for remote installation 24Vdc 70W / 220-240V IP67 Class II selv.	*F990B27A000	212,00 €		

* Nombre maximum de luminaires par source d'alimentation / Max fixtures for each power supply

Nombre maximum de luminaires par source d'alimentation (220÷240 V). Ces données doivent être vérifiées en prenant en compte les conditions spécifiques d'installation.

Max fixtures for each power supply (Vin 220÷240). Data in the chart are provided as a guide only. Please verify according to your installation.

Acc. RF25754	1	Acc. RF25752	5
Acc. RF25748	1	Acc. F990B28A000	14
Acc. RF25747	4	Acc. F990B27A000	29
Acc. RF25757	4		

Gobi



Gobi





Famille / Family

Gobi 180



Power Led

up to 12W
 up to 256 lm - 2700K/CRI 80
 up to 276 lm - 3000K/CRI 80
 up to 296 lm - 4000K/CRI 80

* Net lumen output

2200K available on request.

Gobi 130



Power Led

up to 7W
 up to 140 lm - 2700K/CRI 80
 up to 152 lm - 3000K/CRI 80
 up to 164 lm - 4000K/CRI 80

* Net lumen output

2200K available on request.

Gobi 65



Power Led

up to 3,4W
 up to 60 lm - 2700K/CRI 80
 up to 64 lm - 3000K/CRI 80
 up to 72 lm - 4000K/CRI 80

* Net lumen output

2200K available on request.

Gobi 65 Wall Path



Power Led

up to 3,4W
 up to 47 lm - 2700K/CRI 80
 up to 50 lm - 3000K/CRI 80
 up to 54 lm - 4000K/CRI 80

* Net lumen output

2200K available on request.

Gobi 49



Power Led

up to 2,3W
 up to 40 lm - 2700K/CRI 80
 up to 44 lm - 3000K/CRI 80
 up to 48 lm - 4000K/CRI 80

* Net lumen output

2200K available on request.

Gobi 49 Wall Path



Power Led

up to 2,3W
 up to 36 lm - 2700K/CRI 80
 up to 39 lm - 3000K/CRI 80
 up to 42 lm - 4000K/CRI 80

* Net lumen output

2200K available on request.

Finitions / Colours



01 White



06 Grey



12 Forest Green



18 Deep Brown



30 Black



33 Anthracite

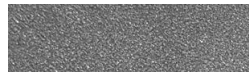

56 Matt Stainless Steel*

* Uniquement pour les versions Gobi 65 et Gobi 49. / Only for Gobi 65 and Gobi 49 versions.

Description / Description

Famille complète de luminaires pour l'éclairage d'allées, encastrables au sol, avec source LED à émission rasante. Disponibles en différentes dimensions et plusieurs ouvertures du faisceau lumineux ajustables. Les vis de fixation sont en acier inoxydable AISI 316L. Boîte de dérivation spécifique nécessaire, à commander séparément. Pour éviter la stagnation d'eau il est nécessaire d'isoler la partie inférieure de la boîte avec une couche de matériau drainant ou un autre système de drainage. Pour garantir le bon maintien de la gaine il est conseillé d'utiliser des câbles électriques flexibles et conçus pour l'extérieur.

Gobi

Luminaire encastrable au sol et sur lequel on peut marcher, disponible en deux diamètres et en trois ouvertures du faisceau lumineux : monodirectionnelle, bidirectionnelle et omnidirectionnelle. La position de la source lumineuse, parallèlement à la surface de maintien, permet de profiter au maximum du composant direct de l'émission lumineuse. Structure en aluminium moulé sous pression EN AB-47100 (à faible teneur en cuivre), couvert d'une double couche de peinture hautement résistante à la corrosion. Verre borosilicate transparent. Équipé d'un raccord fileté M12 qui empêche l'infiltration d'eau et qui garantit une connexion rapide avec le câblage. La version 230V inclut une source d'alimentation et un kit IP66/67 distant qui doit être placé dans la boîte de dérivation encastrable. La version 24V dc est équipée d'un câble et d'un raccord fileté pour la connexion à la source d'alimentation distante. La boîte de dérivation est disponible en deux versions : la version standard en plastique et la version en métal à haute résistance, adaptée aux zones avec un haut flux véhiculaire.

Gobi 49 / Gobi 65

Luminaire encastrable au sol sur lequel on peut marcher, disponible en deux diamètres et avec quatre ouvertures du faisceau lumineux : un faisceau, deux faisceaux, trois faisceaux et quatre faisceaux. Structure en aluminium usiné par tournage, alliage EN AW 6060, avec un traitement anodisé pour une plus grande résistance à la corrosion. Partie extérieure recouverte en acier inoxydable AISI 316L soumis à un procédé de grenailage. Diffuseur en polycarbonate transparent. Luminaire en 24 V dc, nécessite une source d'alimentation à distance à commander séparément.

Gobi 49 Wall / Gobi 65 Wall

Luminaire pour l'éclairage d'allées, encastrable au mur, disponible en deux diamètres et avec une ouverture du faisceaux lumineux de 180° orienté vers le sol. Structure en aluminium usiné par tournage, alliage EN AW 6060, avec un traitement anodisé pour une plus grande résistance à la corrosion. Partie extérieure recouverte en acier inoxydable AISI 316L soumis à un procédé de grenailage. Diffuseur en polycarbonate transparent. Luminaire en 24 V dc, nécessite une source d'alimentation à distance à commander séparément.

Complete family of ground-recessed path lights, with flush-emitting LED source. Available in different dimensions and several adjustable beam angles. The fixing screws are made of AISI 316L stainless steel. Requires a specific junction box to be ordered separately. To avoid water stagnation, it is necessary to insulate the lower part of the box with a layer of drainage material or other drainage system. In order to guarantee the preservation of the cable guide, it is recommended to use flexible electric cables specifically designed for outdoor use.

Gobi

Ground recessed and walk-over luminaire, available in two different diameters and three beam angles: monodirectional, bidirectional and omnidirectional. The position of the light source, parallel to the supporting surface, allows the direct component of the light emission to be exploited to the maximum. EN AB-47100 die-cast aluminium body (with low copper content), coated with a double layer of highly corrosion-resistant paint. Transparent borosilicate glass. Equipped with an M12 screw-on connector that prevents water infiltration and guarantees a quick connection to the wiring unit. 230V versions include the power supply unit and a remote IP66/67 kit to be installed in the junction box for recessing. The 24 V dc version is equipped with a cable and a screw connector for the connection to the remote power supply. The junction box is available in two versions: the standard version made of plastic and the heavy duty metal version, suitable for areas with high vehicular flow.

Gobi 49 / Gobi 65

Ground recessed and walk-over luminaire, available in two different diameters and four beam angles: one beam, two beams, three beams and four beams. Structure in turned aluminium, EN AW 6060 alloy, with an anodized treatment for better resistance to corrosion. The external structure is covered in AISI 316L shot-blasted stainless steel. Transparent polycarbonate diffuser. The 24 V dc luminaire is powered by a remote power supply to be ordered separately.

Gobi 49 Wall / Gobi 65 Wall

Wall-recessed path light, available in two different diameters and with a 180° beam angle directed towards the floor. Structure in turned aluminium, EN AW 6060 alloy, with an anodized treatment for better resistance to corrosion. The external structure is covered in AISI 316L shot-blasted stainless steel. Transparent polycarbonate diffuser. The 24 V dc luminaire is powered by a remote power supply to be ordered separately.

Gobi 180 Mono

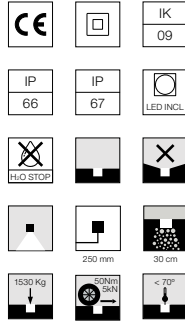
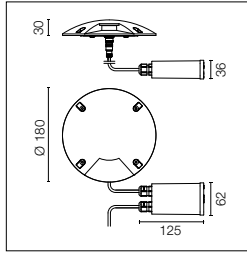

Source LED incluse. Source d'alimentation électrique intégrée 220-240V ON/OFF. Boîte de dérivation nécessaire, à commander séparément. Source d'alimentation équipée d'un câble sortant de 400 mm en néoprène, avec un raccord fileté M12 étanche vers le luminaire et un câble de 300 mm pour la connexion à la ligne électrique. Version avec intensité réglable disponible sur demande.

LED light source included. Integrated electric power supply 220-240V ON/OFF. Requires a junction box to be ordered separately. The luminaire is equipped with a protruding, neoprene, 400 mm cable with an M12 watertight screw-on connector towards the luminaire, and with a 300 mm cable for the connection to the power line. Adjustable light intensity version available upon request.

2200K disponible sur demande.

2200K available on request.

Power Led: 5W - 233 lm \neq OUTPUT 64 lm - 2700K/CRI 80 - 220 \pm 240V / 5W - 250 lm \neq OUTPUT 69 lm - 3000K/CRI 80 - 220 \pm 240V / 5W - 266 lm \neq OUTPUT 74 lm - 4000K/CRI 80 - 220 \pm 240V

2700K

○ FA53504701	375,00 €
● FA53504706	375,00 €
● FA53504712	375,00 €
● FA53504718	375,00 €
● FA53504730	375,00 €
● FA53504733	375,00 €

3000K

○ FA53501201	375,00 €
● FA53501206	375,00 €
● FA53501212	375,00 €
● FA53501218	375,00 €
● FA53501230	375,00 €
● FA53501233	375,00 €

4000K

○ FA53501101	375,00 €
● FA53501106	375,00 €
● FA53501112	375,00 €
● FA53501118	375,00 €
● FA53501130	375,00 €
● FA53501133	375,00 €

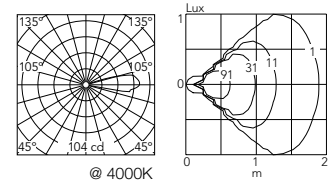

Gobi 180 Mono Low Voltage

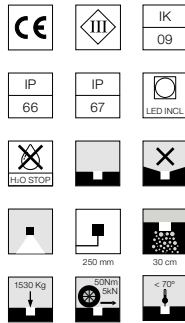
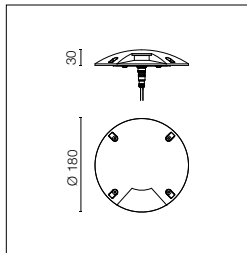

Source LED incluse. Source d'alimentation électrique à distance 24V dc à commander séparément. Boîte de dérivation nécessaire, à commander séparément. Équipé d'un câble sortant de 250 mm avec un raccord fileté M12 étanche. Accessoires optionnels : câble de 5000 mm et câble splitter de 300 mm avec des raccords M12 pour les installations multiples.

LED source included. 24V dc remote electric power supply to be ordered separately. Requires a junction box to be ordered separately. The luminaire is equipped with protruding, 250 mm cable with an M12 watertight screw-on connector. Optional accessories: 5000 mm cable and 300 mm splitter cable with M12 connectors for multiple installations.

2200K disponible sur demande.

2200K available on request.

Power Led: 3,4W - 233 lm \neq OUTPUT 64 lm - 2700K/CRI 80 - 24Vdc / 3,4W - 250 lm \neq OUTPUT 69 lm - 3000K/CRI 80 - 24Vdc / 3,4W - 266 lm \neq OUTPUT 74 lm - 4000K/CRI 80 - 24Vdc

2700K

○ FA53504801	273,00 €
● FA53504806	273,00 €
● FA53504812	273,00 €
● FA53504818	273,00 €
● FA53504830	273,00 €
● FA53504833	273,00 €

3000K

○ FA53503001	273,00 €
● FA53503006	273,00 €
● FA53503012	273,00 €
● FA53503018	273,00 €
● FA53503030	273,00 €
● FA53503033	273,00 €

4000K

○ FA53502901	273,00 €
● FA53502906	273,00 €
● FA53502912	273,00 €
● FA53502918	273,00 €
● FA53502930	273,00 €
● FA53502933	273,00 €

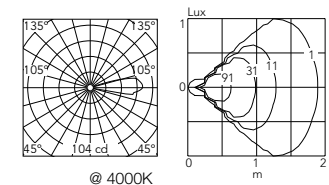

* Nombre maximum de luminaires par source d'alimentation / Maximum number of luminaires per power supply.

Nombre maximum de luminaires par source d'alimentation (220 \pm 240 V). Ces données doivent être vérifiées en prenant en compte les conditions spécifiques d'installation.

Maximum number of luminaires per power supply. (220 \pm 240 V). These data must be checked taking into account the specific installation conditions.

Acc. RF25752	3
Acc. F990B28A000	8
Acc. F990B27A000	16

Gobi 130 Mono

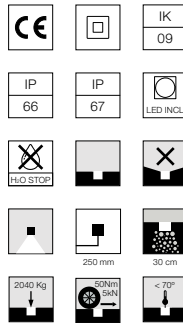
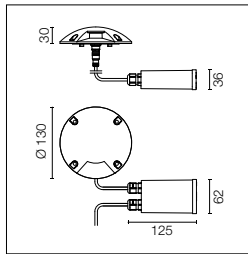

Source LED incluse. Source d'alimentation électrique intégrée 220-240V ON/OFF. Boîte de dérivation nécessaire, à commander séparément. Source d'alimentation équipée d'un câble sortant de 400 mm en néoprène, avec un raccord fileté M12 étanche vers le luminaire et un câble de 300 mm pour la connexion à la ligne électrique. Version avec intensité réglable disponible sur demande.

LED light source included. Integrated electric power supply 220-240V ON/OFF. Requires a junction box to be ordered separately. The luminaire is equipped with a protruding, neoprene, 400 mm cable with an M12 watertight screw-on connector towards the luminaire, and with a 300 mm cable for the connection to the power line. Adjustable light intensity version available upon request.

2200K disponible sur demande.

2200K available on request.

Power Led: 4W - 129 lm ≠ OUTPUT 35 lm - 2700K/CRI 80 - 220÷240V / 4W - 139 lm ≠ OUTPUT 38 lm - 3000K/CRI 80 - 220÷240V / 4W - 148 lm ≠ OUTPUT 41 lm - 4000K/CRI 80 - 220÷240V

2700K		3000K		4000K	
○ FA53504101	273,00 €	○ FA53500301	273,00 €	○ FA53500201	273,00 €
● FA53504106	273,00 €	● FA53500306	273,00 €	● FA53500206	273,00 €
● FA53504112	273,00 €	● FA53500312	273,00 €	● FA53500212	273,00 €
● FA53504118	273,00 €	● FA53500318	273,00 €	● FA53500218	273,00 €
● FA53504130	273,00 €	● FA53500330	273,00 €	● FA53500230	273,00 €
● FA53504133	273,00 €	● FA53500333	273,00 €	● FA53500233	273,00 €

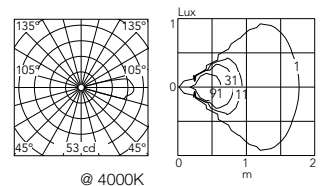

Gobi 130 Mono Low Voltage

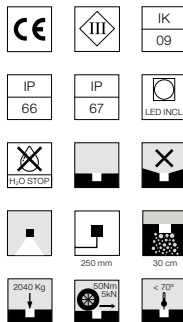
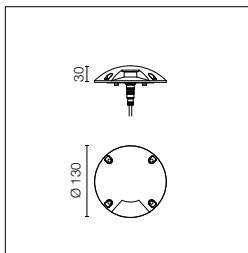

Source LED incluse. Source d'alimentation électrique à distance 24V dc à commander séparément. Boîte de dérivation nécessaire, à commander séparément. Équipé d'un câble sortant de 250 mm avec un raccord fileté M12 étanche. Accessoires optionnels : câble de 5000 mm et câble splitter de 300 mm avec des raccords M12 pour les installations multiples.

LED source included. 24V dc remote electric power supply to be ordered separately. Requires a junction box to be ordered separately. The luminaire is equipped with protruding, 250 mm cable with an M12 watertight screw-on connector. Optional accessories: 5000 mm cable and 300 mm splitter cable with M12 connectors for multiple installations.

2200K disponible sur demande.

2200K available on request.

Power Led: 1,9W - 129 lm ≠ OUTPUT 35 lm - 2700K/CRI 80 - 24Vdc / 1,9W - 139 lm ≠ OUTPUT 38 lm - 3000K/CRI 80 - 24Vdc / 1,9W - 148 lm ≠ OUTPUT 41 lm - 4000K/CRI 80 - 24Vdc

2700K		3000K		4000K	
○ FA53504201	172,00 €	○ FA53502101	172,00 €	○ FA53502001	172,00 €
● FA53504206	172,00 €	● FA53502106	172,00 €	● FA53502006	172,00 €
● FA53504212	172,00 €	● FA53502112	172,00 €	● FA53502012	172,00 €
● FA53504218	172,00 €	● FA53502118	172,00 €	● FA53502018	172,00 €
● FA53504230	172,00 €	● FA53502130	172,00 €	● FA53502030	172,00 €
● FA53504233	172,00 €	● FA53502133	172,00 €	● FA53502033	172,00 €

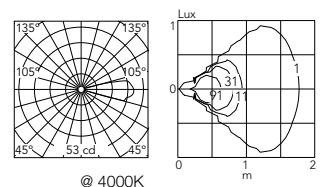

* Nombre maximum de luminaires par source d'alimentation / Maximum number of luminaires per power supply.

Nombre maximum de luminaires par source d'alimentation (220÷240 V). Ces données doivent être vérifiées en prenant en compte les conditions spécifiques d'installation.

Maximum number of luminaires per power supply. (220÷240 V). These data must be checked taking into account the specific installation conditions.

Acc. RF25752	5
Acc. F990B28A000	16
Acc. F990B27A000	33

Gobi 180 Double

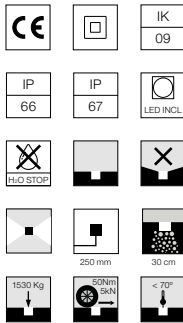
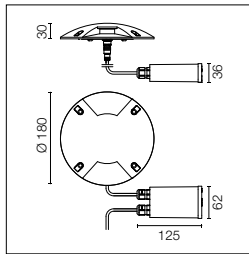

Source LED incluse. Source d'alimentation électrique intégrée 220-240V ON/OFF. Boîte de dérivation nécessaire, à commander séparément. Source d'alimentation équipée d'un câble sortant de 400 mm en néoprène, avec un raccord fileté M12 étanche vers le luminaire et un câble de 300 mm pour la connexion à la ligne électrique. Version avec intensité réglable disponible sur demande.

LED light source included. Integrated electric power supply 220-240V ON/OFF. Requires a junction box to be ordered separately. The luminaire is equipped with a protruding, neoprene, 400 mm cable with an M12 watertight screw-on connector towards the luminaire, and with a 300 mm cable for the connection to the power line. Adjustable light intensity version available upon request.

2200K disponible sur demande.

2200K available on request.

Power Led: 7W - 2x233 lm ≠ OUTPUT 2x64 lm - 2700K/CRI 80 - 220÷240V / 7W - 2x250 lm ≠ OUTPUT 2x69 lm - 3000K/CRI 80 - 220÷240V / 7W - 2x266 lm ≠ OUTPUT 2x74 lm - 4000K/CRI 80 - 220÷240V

2700K

○ FA53504901	410,00 €
● FA53504906	410,00 €
● FA53504912	410,00 €
● FA53504918	410,00 €
● FA53504930	410,00 €
● FA53504933	410,00 €

3000K

○ FA53501501	410,00 €
● FA53501506	410,00 €
● FA53501512	410,00 €
● FA53501518	410,00 €
● FA53501530	410,00 €
● FA53501533	410,00 €

4000K

○ FA53501401	410,00 €
● FA53501406	410,00 €
● FA53501412	410,00 €
● FA53501418	410,00 €
● FA53501430	410,00 €
● FA53501433	410,00 €

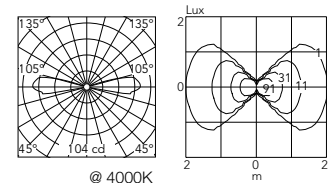

Gobi 180 Double Low Voltage

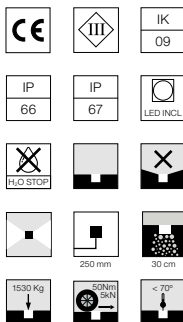
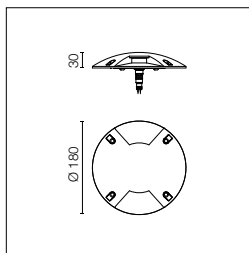

Source LED incluse. Source d'alimentation électrique à distance 24V dc à commander séparément. Boîte de dérivation nécessaire, à commander séparément. Équipé d'un câble sortant de 250 mm avec un raccord fileté M12 étanche. Accessoires optionnels : câble de 5000 mm et câble splitter de 300 mm avec des raccords M12 pour les installations multiples.

LED source included. 24V dc remote electric power supply to be ordered separately. Requires a junction box to be ordered separately. The luminaire is equipped with protruding, 250 mm cable with an M12 watertight screw-on connector. Optional accessories: 5000 mm cable and 300 mm splitter cable with M12 connectors for multiple installations.

2200K disponible sur demande.

2200K available on request.

Power Led: 6,4W - 2x233 lm ≠ OUTPUT 2x64 lm - 2700K/CRI 80 - 24Vdc / 6,4W - 2x250 lm ≠ OUTPUT 2x69 lm - 3000K/CRI 80 - 24Vdc / 6,4W - 2x266 lm ≠ OUTPUT 2x74 lm - 4000K/CRI 80 - 24Vdc

2700K

○ FA53505001	304,00 €
● FA53505006	304,00 €
● FA53505012	304,00 €
● FA53505018	304,00 €
● FA53505030	304,00 €
● FA53505033	304,00 €

3000K

○ FA53503301	304,00 €
● FA53503306	304,00 €
● FA53503312	304,00 €
● FA53503318	304,00 €
● FA53503330	304,00 €
● FA53503333	304,00 €

4000K

○ FA53503201	304,00 €
● FA53503206	304,00 €
● FA53503212	304,00 €
● FA53503218	304,00 €
● FA53503230	304,00 €
● FA53503233	304,00 €

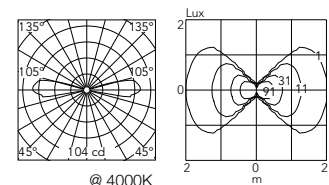

* Nombre maximum de luminaires par source d'alimentation / Maximum number of luminaires per power supply.

Nombre maximum de luminaires par source d'alimentation (220÷240 V). Ces données doivent être vérifiées en prenant en compte les conditions spécifiques d'installation.	Maximum number of luminaires per power supply. (220÷240 V). These data must be checked taking into account the specific installation conditions.	Acc. RF25752	2
		Acc. F990B28A000	5
		Acc. F990B27A000	8

Gobi 130 Double

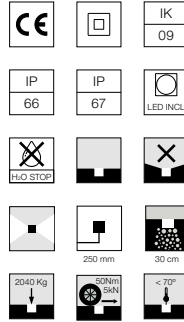
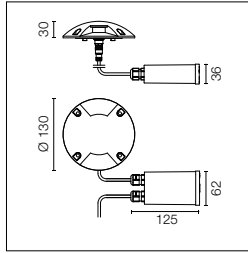

Source LED incluse. Source d'alimentation électrique intégrée 220-240V ON/OFF. Boîte de dérivation nécessaire, à commander séparément. Source d'alimentation équipée d'un câble sortant de 400 mm en néoprène, avec un raccord fileté M12 étanche vers le luminaire et un câble de 300 mm pour la connexion à la ligne électrique. Version avec intensité réglable disponible sur demande.

LED light source included. Integrated electric power supply 220-240V ON/OFF. Requires a junction box to be ordered separately. The luminaire is equipped with a protruding, neoprene, 400 mm cable with an M12 watertight screw-on connector towards the luminaire, and with a 300 mm cable for the connection to the power line. Adjustable light intensity version available upon request.

2200K disponible sur demande.

2200K available on request.

Power Led: 5W - 2x129 lm ≠ OUTPUT 2x35 lm - 2700K/CRI 80 - 220÷240V / 5W - 2x139 lm ≠ OUTPUT 2x38 lm - 3000K/CRI 80 - 220÷240V / 5W - 2x148 lm ≠ OUTPUT 2x41 lm - 4000K/CRI 80 - 220÷240V

2700K		3000K		4000K	
○ FA53504301	318,00 €	○ FA53500601	318,00 €	○ FA53500501	318,00 €
● FA53504306	318,00 €	● FA53500606	318,00 €	● FA53500506	318,00 €
● FA53504312	318,00 €	● FA53500612	318,00 €	● FA53500512	318,00 €
● FA53504318	318,00 €	● FA53500618	318,00 €	● FA53500518	318,00 €
● FA53504330	318,00 €	● FA53500630	318,00 €	● FA53500530	318,00 €
● FA53504333	318,00 €	● FA53500633	318,00 €	● FA53500533	318,00 €

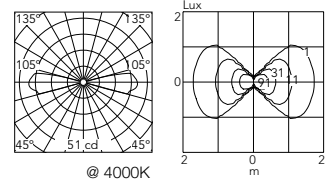

Gobi 130 Double Low Voltage

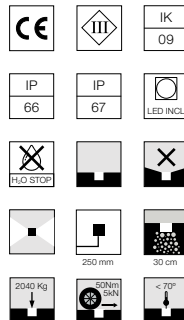
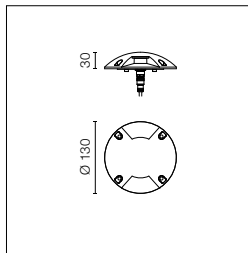

Source LED incluse. Source d'alimentation électrique à distance 24V dc à commander séparément. Boîte de dérivation nécessaire, à commander séparément. Équipé d'un câble sortant de 250 mm avec un raccord fileté M12 étanche. Accessoires optionnels : câble de 5000 mm et câble splitter de 300 mm avec des raccords M12 pour les installations multiples.

LED source included. 24V dc remote electric power supply to be ordered separately. Requires a junction box to be ordered separately. The luminaire is equipped with protruding, 250 mm cable with an M12 watertight screw-on connector. Optional accessories: 5000 mm cable and 300 mm splitter cable with M12 connectors for multiple installations.

2200K disponible sur demande.

2200K available on request.

Power Led: 3,5W - 2x129 lm ≠ OUTPUT 2x35 lm - 2700K/CRI 80 - 24Vdc / 3,5W - 2x139 lm ≠ OUTPUT 2x38 lm - 3000K/CRI 80 - 24Vdc / 3,5W - 2x148 lm ≠ OUTPUT 2x41 lm - 4000K/CRI 80 - 24Vdc

2700K		3000K		4000K	
○ FA53504401	216,00 €	○ FA53502401	216,00 €	○ FA53502301	216,00 €
● FA53504406	216,00 €	● FA53502406	216,00 €	● FA53502306	216,00 €
● FA53504412	216,00 €	● FA53502412	216,00 €	● FA53502312	216,00 €
● FA53504418	216,00 €	● FA53502418	216,00 €	● FA53502318	216,00 €
● FA53504430	216,00 €	● FA53502430	216,00 €	● FA53502330	216,00 €
● FA53504433	216,00 €	● FA53502433	216,00 €	● FA53502333	216,00 €

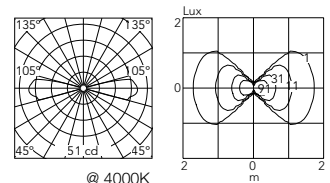

* Nombre maximum de luminaires par source d'alimentation / Maximum number of luminaires per power supply.

Nombre maximum de luminaires par source d'alimentation (220÷240 V). Ces données doivent être vérifiées en prenant en compte les conditions spécifiques d'installation.	Maximum number of luminaires per power supply. (220÷240 V). These data must be checked taking into account the specific installation conditions.	Acc.	2
		Acc. RF25752	2
		Acc. F990B28A000	10
		Acc. F990B27A000	19

Gobi 180 Multi

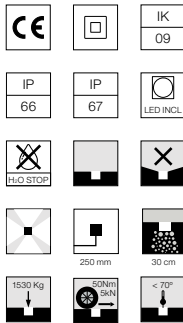
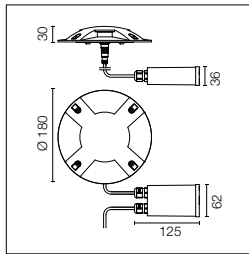

Source LED incluse. Source d'alimentation électrique intégrée 220-240V ON/OFF. Boîte de dérivation nécessaire, à commander séparément. Source d'alimentation équipée d'un câble sortant de 400 mm en néoprène, avec un raccord fileté M12 étanche vers le luminaire et un câble de 300 mm pour la connexion à la ligne électrique. Version avec intensité réglable disponible sur demande.

LED light source included. Integrated electric power supply 220-240V ON/OFF. Requires a junction box to be ordered separately. The luminaire is equipped with a protruding, neoprene, 400 mm cable with an M12 watertight screw-on connector towards the luminaire, and with a 300 mm cable for the connection to the power line. Adjustable light intensity version available upon request.

2200K disponible sur demande.

2200K available on request.

Power Led: 12W - 4x233 lm \neq OUTPUT 4x64 lm - 2700K/CRI 80 - 220 \pm 240V / 12W - 4x250 lm \neq OUTPUT 4x69 lm - 3000K/CRI 80 - 220 \pm 240V / 12W - 4x266 lm \neq OUTPUT 4x74 lm - 4000K/CRI 80 - 220 \pm 240V

2700K

○ FA53505101	466,00 €
● FA53505106	466,00 €
● FA53505112	466,00 €
● FA53505118	466,00 €
● FA53505130	466,00 €
● FA53505133	466,00 €

3000K

○ FA53501801	466,00 €
● FA53501806	466,00 €
● FA53501812	466,00 €
● FA53501818	466,00 €
● FA53501830	466,00 €
● FA53501833	466,00 €

4000K

○ FA53501701	466,00 €
● FA53501706	466,00 €
● FA53501712	466,00 €
● FA53501718	466,00 €
● FA53501730	466,00 €
● FA53501733	466,00 €

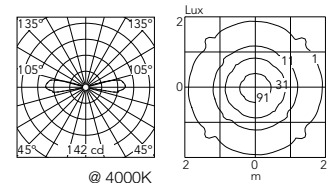

Gobi 180 Multi Low Voltage

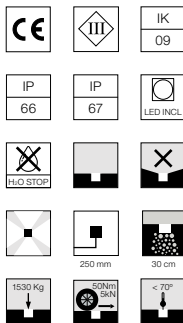
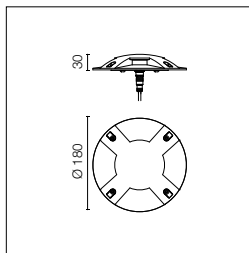

Source LED incluse. Source d'alimentation électrique à distance 24V dc à commander séparément. Boîte de dérivation nécessaire, à commander séparément. Équipé d'un câble sortant de 250 mm avec un raccord fileté M12 étanche. Accessoires optionnels : câble de 5000 mm et câble splitter de 300 mm avec des raccords M12 pour les installations multiples.

LED source included. 24V dc remote electric power supply to be ordered separately. Requires a junction box to be ordered separately. The luminaire is equipped with protruding, 250 mm cable with an M12 watertight screw-on connector. Optional accessories: 5000 mm cable and 300 mm splitter cable with M12 connectors for multiple installations.

2200K disponible sur demande.

2200K available on request.

Power Led: 11,2W - 4x233 lm \neq OUTPUT 4x64 lm - 2700K/CRI 80 - 24Vdc / 11,2W - 4x250 lm \neq OUTPUT 4x69 lm - 3000K/CRI 80 - 24Vdc / 11,2W - 4x266 lm \neq OUTPUT 4x74 lm - 4000K/CRI 80 - 24Vdc

2700K

○ FA53505201	363,00 €
● FA53505206	363,00 €
● FA53505212	363,00 €
● FA53505218	363,00 €
● FA53505230	363,00 €
● FA53505233	363,00 €

3000K

○ FA53503601	363,00 €
● FA53503606	363,00 €
● FA53503612	363,00 €
● FA53503618	363,00 €
● FA53503630	363,00 €
● FA53503633	363,00 €

4000K

○ FA53503501	363,00 €
● FA53503506	363,00 €
● FA53503512	363,00 €
● FA53503518	363,00 €
● FA53503530	363,00 €
● FA53503533	363,00 €

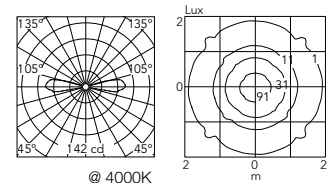

* Nombre maximum de luminaires par source d'alimentation / Maximum number of luminaires per power supply.

Nombre maximum de luminaires par source d'alimentation (220 \pm 240 V). Ces données doivent être vérifiées en prenant en compte les conditions spécifiques d'installation.

Maximum number of luminaires per power supply. (220 \pm 240 V). These data must be checked taking into account the specific installation conditions.

Acc. RF25752	1
Acc. F990B28A000	3
Acc. F990B27A000	6

Gobi 130 Multi

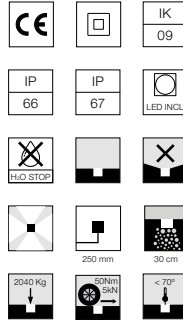
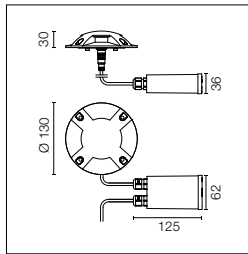

Source LED incluse. Source d'alimentation électrique intégrée 220-240V ON/OFF. Boîte de dérivation nécessaire, à commander séparément. Source d'alimentation équipée d'un câble sortant de 400 mm en néoprène, avec un raccord fileté M12 étanche vers le luminaire et un câble de 300 mm pour la connexion à la ligne électrique. Version avec intensité réglable disponible sur demande.

LED light source included. Integrated electric power supply 220-240V ON/OFF. Requires a junction box to be ordered separately. The luminaire is equipped with a protruding, neoprene, 400 mm cable with an M12 watertight screw-on connector towards the luminaire, and with a 300 mm cable for the connection to the power line. Adjustable light intensity version available upon request.

2200K disponible sur demande.

2200K available on request.

Power Led: 7W - 4x129 lm ≠ OUTPUT 4x35 lm - 2700K/CRI 80 - 220÷240V / 7W - 4x139 lm ≠ OUTPUT 4x38 lm - 3000K/CRI 80 - 220÷240V / 7W - 4x148 lm ≠ OUTPUT 4x41 lm - 4000K/CRI 80 - 220÷240V

2700K		3000K		4000K	
○ FA53504501	363,00 €	○ FA53500901	363,00 €	○ FA53500801	363,00 €
● FA53504506	363,00 €	● FA53500906	363,00 €	● FA53500806	363,00 €
● FA53504512	363,00 €	● FA53500912	363,00 €	● FA53500812	363,00 €
● FA53504518	363,00 €	● FA53500918	363,00 €	● FA53500818	363,00 €
● FA53504530	363,00 €	● FA53500930	363,00 €	● FA53500830	363,00 €
● FA53504533	363,00 €	● FA53500933	363,00 €	● FA53500833	363,00 €

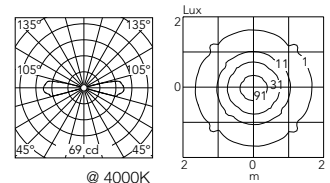

Gobi 130 Multi Low Voltage

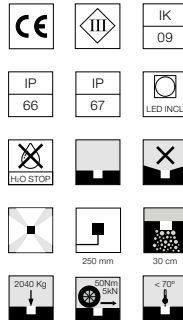
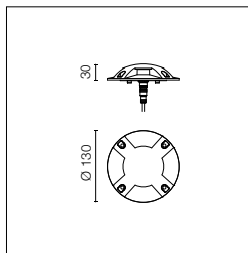

Source LED incluse. Source d'alimentation électrique à distance 24V dc à commander séparément. Boîte de dérivation nécessaire, à commander séparément. Équipé d'un câble sortant de 250 mm avec un raccord fileté M12 étanche. Accessoires optionnels : câble de 5000 mm et câble splitter de 300 mm avec des raccords M12 pour les installations multiples.

LED source included. 24V dc remote electric power supply to be ordered separately. Requires a junction box to be ordered separately. The luminaire is equipped with protruding, 250 mm cable with an M12 watertight screw-on connector. Optional accessories: 5000 mm cable and 300 mm splitter cable with M12 connectors for multiple installations.

2200K disponible sur demande.

2200K available on request.

Power Led: 5,8W - 4x129 lm ≠ OUTPUT 4x35 lm - 2700K/CRI 80 - 24Vdc / 5,8W - 4x139 lm ≠ OUTPUT 4x38 lm - 3000K/CRI 80 - 24Vdc / 5,8W - 4x148 lm ≠ OUTPUT 4x41 lm - 4000K/CRI 80 - 24Vdc

2700K		3000K		4000K	
○ FA53504601	261,00 €	○ FA53502701	261,00 €	○ FA53502601	261,00 €
● FA53504606	261,00 €	● FA53502706	261,00 €	● FA53502606	261,00 €
● FA53504612	261,00 €	● FA53502712	261,00 €	● FA53502612	261,00 €
● FA53504618	261,00 €	● FA53502718	261,00 €	● FA53502618	261,00 €
● FA53504630	261,00 €	● FA53502730	261,00 €	● FA53502630	261,00 €
● FA53504633	261,00 €	● FA53502733	261,00 €	● FA53502633	261,00 €

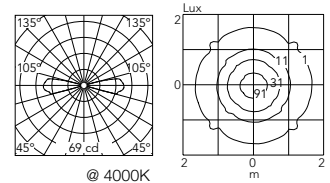

* Nombre maximum de luminaires par source d'alimentation / Maximum number of luminaires per power supply.

Nombre maximum de luminaires par source d'alimentation (220÷240 V). Ces données doivent être vérifiées en prenant en compte les conditions spécifiques d'installation.

Maximum number of luminaires per power supply. (220÷240 V). These data must be checked taking into account the specific installation conditions.

Acc. RF25752	1
Acc. F990B28A000	7
Acc. F990B27A000	12

Gobi: Accessoires / Accessories

Boitier.	Box for installation.	Gobi 180 FA194	27,00 €		
Base de fixation à terre haute résistance.	High resistance in-ground box for installation	Gobi 180 FA195	88,00 €		
Boitier.	Box for installation.	Gobi 130 FA192	21,00 €		
Base de fixation à terre haute résistance.	High resistance in-ground box for installation	Gobi 130 FA193	56,00 €		

Gobi 130/180 220÷240V version - Wiring Installation

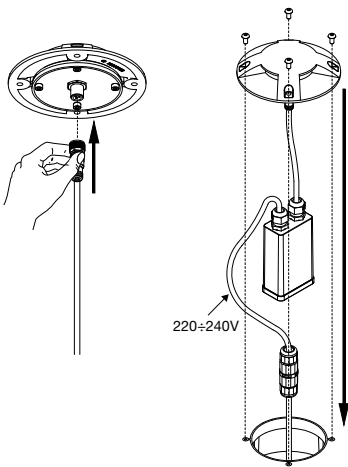

Example of installation

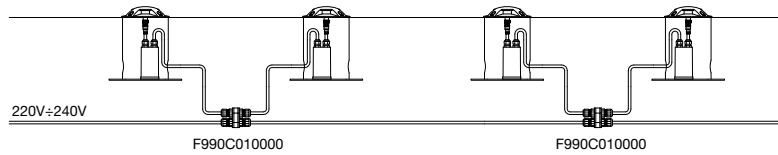

Gobi 130/180 24Vdc version - Wiring Installation

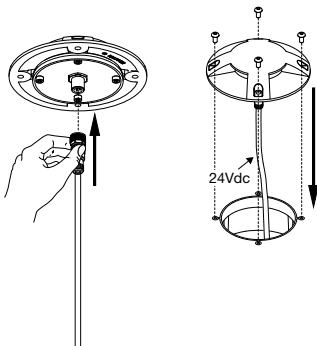

Example of installation 1

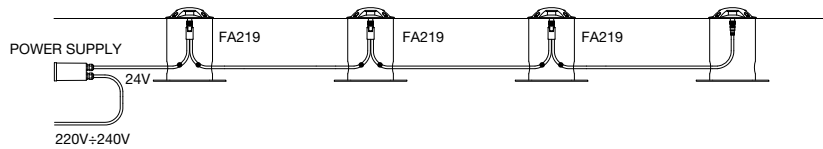

Example of installation 2

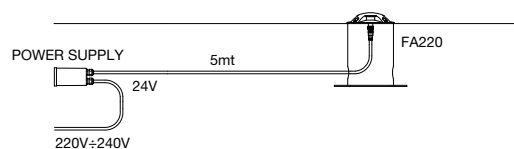

Gobi: Appareillages électriques / Drivers

<p>Système de jonction IP68 à 2 voies 2 pôles. (Ø4÷6,9mm câble). Il ne peut pas être placé dans le boîtier encastré pour l'installation.</p>	<p>2 way terminal block 2 poles IP68. (Ø4÷6,9mm cable).</p> <p>It can't be placed in the recessed box for installation.</p>	F990C050000	34,00 €		
<p>Système de jonction IP68 H2O Stop anti-condensation à 2 voies 4 pôles.</p>	<p>2 way terminal block 4 poles IP68 H2O Stop.</p>	F990C00A000	33,00 €		
<p>Système de jonction IP68 H2O Stop anti-condensation à 3/4 voies 4 pôles. (Ø5,5÷12mm câble).</p>	<p>3/4 way terminal block 4 poles IP68 H2O Stop. (ø5,5÷12mm cable).</p>	F990C010000	60,00 €		
<p>Dispositif de protection contre les surtensions. 275Vac. Courant de décharge maximal 10KA (8/20us). Courant de fonctionnement maximal 5A. Adapté pour les connexions en séries. IP66.</p>	<p>Surge protection device. 275Vac. Maximum discharge current 10KA (8/20us). Maximum operating current 5A. Suitable for series connection. IP66.</p>	F990E00A000	116,00 €		

Gobi Low Voltage: Appareillages électriques / Drivers

<p>Connecteur splitter m12.</p>	<p>Splitter m12 connector.</p>	FA219	28,00 €		
<p>Connecteur individuel m12 de 5000 mm.</p>	<p>M12 single connector L.5.000mm.</p>	FA220	34,00 €		
<p>Équipement d'alimentation pour installation à distance 24Vdc 20W / 220-240V IP67 Classe II selv.</p>	<p>Power supply for remote installation 24Vdc 20W / 220-240V IP67 Class II selv.</p>	*RF25752	133,00 €		
<p>Équipement d'alimentation pour installation à distance 24Vdc 50W / 120-240V IP67 Classe II selv.</p>	<p>Power supply for remote installation 24Vdc 50W / 120-240V IP67 Class II selv.</p>	*F990B28A000	251,00 €		
<p>Équipement d'alimentation pour installation à distance 24Vdc 70W / 220-240V IP67 Classe II selv.</p>	<p>Power supply for remote installation 24Vdc 70W / 220-240V IP67 Class II selv.</p>	*F990B27A000	212,00 €		

Gobi 65 Mono

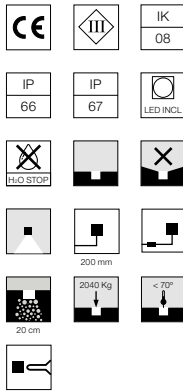
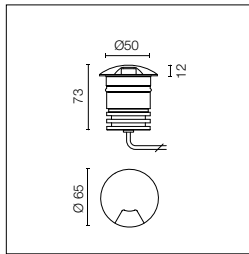

Source LED incluse. Source d'alimentation électrique à distance 24V dc à commander séparément. Boîte de dérivation nécessaire, à commander séparément. Équipé d'un câble sortant de 200 mm en néoprène, avec un système de connexion intégré H2O STOP et d'un kit avec des connecteurs sertissables et des gaines thermorétractables adhésives qui garantissent l'étanchéité de la connexion. Version avec intensité réglable disponible sur demande.

LED source included. 24V dc remote electric power supply to be ordered separately. Requires a junction box to be ordered separately. The luminaire is equipped with a protruding, 200 mm cable with an integrated H2O STOP connection system and a wiring kit with crimp connectors and adhesive heat-shrink tubing guaranteeing the water tightness of the connection. Adjustable light intensity version available upon request.

2200K disponible sur demande.

2200K available on request.

Power Led: 3,4W - 169 lm ≠ OUTPUT 15 lm - 2700K/CRI 80 - 24Vdc / 3,4W - 182 lm ≠ OUTPUT 16 lm - 3000K/CRI 80 - 24Vdc / 3,4W - 198 lm ≠ OUTPUT 18 lm - 4000K/CRI 80 - 24Vdc

2700K

○ FA51824201	215,00 €
● FA51824206	215,00 €
● FA51824212	215,00 €
● FA51824218	215,00 €
● FA51824230	215,00 €
● FA51824233	215,00 €
● FA51824256	200,00 €

3000K

○ FA51804301	215,00 €
● FA51804306	215,00 €
● FA51804312	215,00 €
● FA51804318	215,00 €
● FA51804330	215,00 €
● FA51804333	215,00 €
● FA51804356	200,00 €

4000K

○ FA51804201	215,00 €
● FA51804206	215,00 €
● FA51804212	215,00 €
● FA51804218	215,00 €
● FA51804230	215,00 €
● FA51804233	215,00 €
● FA51804256	200,00 €

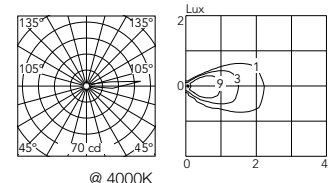

Gobi 65 Double

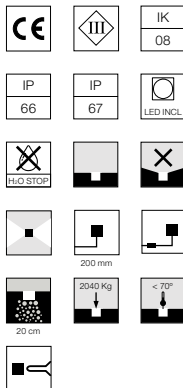
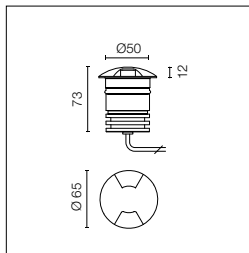

Source LED incluse. Source d'alimentation électrique à distance 24V dc à commander séparément. Boîte de dérivation nécessaire, à commander séparément. Équipé d'un câble sortant de 200 mm en néoprène, avec un système de connexion intégré H2O STOP et d'un kit avec des connecteurs sertissables et des gaines thermorétractables adhésives qui garantissent l'étanchéité de la connexion. Version avec intensité réglable disponible sur demande.

LED source included. 24V dc remote electric power supply to be ordered separately. Requires a junction box to be ordered separately. The luminaire is equipped with a protruding, 200 mm cable with an integrated H2O STOP connection system and a wiring kit with crimp connectors and adhesive heat-shrink tubing guaranteeing the water tightness of the connection. Adjustable light intensity version available upon request.

2200K disponible sur demande.

2200K available on request.

Power Led: 3,4W - 2x169 lm ≠ OUTPUT 2x15 lm - 2700K/CRI 80 - 24Vdc / 3,4W - 2x182 lm ≠ OUTPUT 2x16 lm - 3000K/CRI 80 - 24Vdc / 3,4W - 2x198 lm ≠ OUTPUT 2x18 lm - 4000K/CRI 80 - 24Vdc

2700K

○ FA51825201	215,00 €
● FA51825206	215,00 €
● FA51825212	215,00 €
● FA51825218	215,00 €
● FA51825230	215,00 €
● FA51825233	215,00 €
● FA51825256	200,00 €

3000K

○ FA51805301	215,00 €
● FA51805306	215,00 €
● FA51805312	215,00 €
● FA51805318	215,00 €
● FA51805330	215,00 €
● FA51805333	215,00 €
● FA51805356	200,00 €

4000K

○ FA51805201	215,00 €
● FA51805206	215,00 €
● FA51805212	215,00 €
● FA51805218	215,00 €
● FA51805230	215,00 €
● FA51805233	215,00 €
● FA51805256	200,00 €

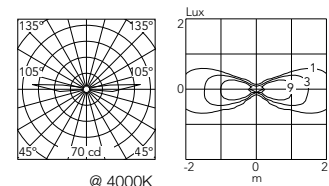

Gobi 65 Triple

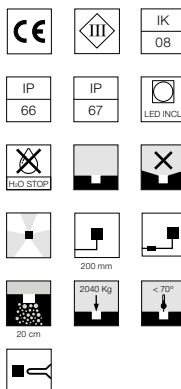
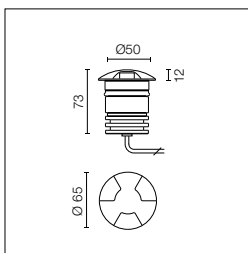

Source LED incluse. Source d'alimentation électrique à distance 24V dc à commander séparément. Boîte de dérivation nécessaire, à commander séparément. Équipé d'un câble sortant de 200 mm en néoprène, avec un système de connexion intégré H2O STOP et d'un kit avec des connecteurs sertissables et des gaines thermorétractables adhésives qui garantissent l'étanchéité de la connexion. Version avec intensité réglable disponible sur demande.

LED source included. 24V dc remote electric power supply to be ordered separately. Requires a junction box to be ordered separately. The luminaire is equipped with a protruding, 200 mm cable with an integrated H2O STOP connection system and a wiring kit with crimp connectors and adhesive heat-shrink tubing guaranteeing the water tightness of the connection. Adjustable light intensity version available upon request.

2200K disponible sur demande.

2200K available on request.

Power Led: 3,4W - 3x169 lm ≠ OUTPUT 3x15 lm - 2700K/CRI 80 - 24Vdc / 3,4W - 3x182 lm ≠ OUTPUT 3x16 lm - 3000K/CRI 80 - 24Vdc / 3,4W - 3x198 lm ≠ OUTPUT 3x18 lm - 4000K/CRI 80 - 24Vdc

2700K

○ FA51826201	215,00 €
● FA51826206	215,00 €
● FA51826212	215,00 €
● FA51826218	215,00 €
● FA51826230	215,00 €
● FA51826233	215,00 €
● FA51826256	200,00 €

3000K

○ FA51806301	215,00 €
● FA51806306	215,00 €
● FA51806312	215,00 €
● FA51806318	215,00 €
● FA51806330	215,00 €
● FA51806333	215,00 €
● FA51806356	200,00 €

4000K

○ FA51806201	215,00 €
● FA51806206	215,00 €
● FA51806212	215,00 €
● FA51806218	215,00 €
● FA51806230	215,00 €
● FA51806233	215,00 €
● FA51806256	200,00 €

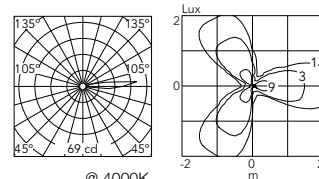

Gobi 65 Multi

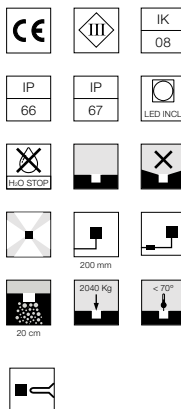
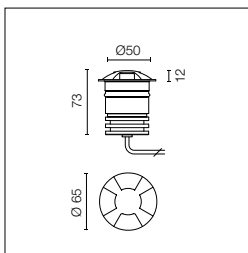

Source LED incluse. Source d'alimentation électrique à distance 24V dc à commander séparément. Boîte de dérivation nécessaire, à commander séparément. Équipé d'un câble sortant de 200 mm en néoprène, avec un système de connexion intégré H2O STOP et d'un kit avec des connecteurs sertissables et des gaines thermorétractables adhésives qui garantissent l'étanchéité de la connexion. Version avec intensité réglable disponible sur demande.

LED source included. 24V dc remote electric power supply to be ordered separately. Requires a junction box to be ordered separately. The luminaire is equipped with a protruding, 200 mm cable with an integrated H2O STOP connection system and a wiring kit with crimp connectors and adhesive heat-shrink tubing guaranteeing the water tightness of the connection. Adjustable light intensity version available upon request.

2200K disponible sur demande.

2200K available on request.

Power Led: 3,4W - 4x169 lm ≠ OUTPUT 4x15 lm - 2700K/CRI 80 - 24Vdc / 3,4W - 4x182 lm ≠ OUTPUT 4x16 lm - 3000K/CRI 80 - 24Vdc / 3,4W - 4x198 lm ≠ OUTPUT 4x18 lm - 4000K/CRI 80 - 24Vdc

2700K

○ FA51827201	215,00 €
● FA51827206	215,00 €
● FA51827212	215,00 €
● FA51827218	215,00 €
● FA51827230	215,00 €
● FA51827233	215,00 €
● FA51827256	200,00 €

3000K

○ FA51807301	215,00 €
● FA51807306	215,00 €
● FA51807312	215,00 €
● FA51807318	215,00 €
● FA51807330	215,00 €
● FA51807333	215,00 €
● FA51807356	200,00 €

4000K

○ FA51807201	215,00 €
● FA51807206	215,00 €
● FA51807212	215,00 €
● FA51807218	215,00 €
● FA51807230	215,00 €
● FA51807233	215,00 €
● FA51807256	200,00 €

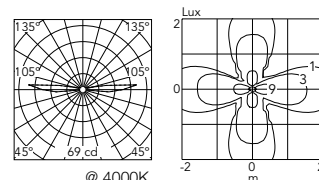

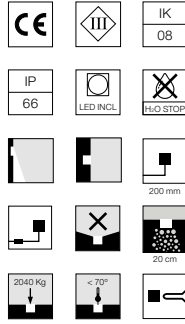
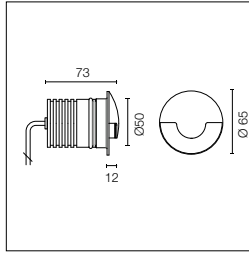

Source LED incluse. Source d'alimentation électrique à distance 24V dc à commander séparément. Boîte de dérivation nécessaire, à commander séparément. Équipé d'un câble sortant de 200 mm en néoprène, et d'un kit avec des connecteurs sertissables et des gaines thermorétractables adhésives qui garantissent l'étanchéité de la connexion. Version avec intensité réglable disponible sur demande.

LED source included. 24V dc remote electric power supply to be ordered separately. Requires a junction box to be ordered separately. The luminaire is equipped with a protruding, 200 mm cable and a wiring kit with crimp connectors and adhesive heat-shrink tubing guaranteeing the water tightness of the connection. Adjustable light intensity version available upon request.

2200K disponible sur demande.

2200K available on request.

Power Led: 3,4W - 169 lm ≠ OUTPUT 47 lm - 2700K/CRI 80 - 24Vdc / 3,4W - 182 lm ≠ OUTPUT 50 lm - 3000K/CRI 80 - 24Vdc / 3,4W - 198 lm ≠ OUTPUT 54 lm - 4000K/CRI 80 - 24Vdc

2700K

○ FA51828201	215,00 €
● FA51828206	215,00 €
● FA51828212	215,00 €
● FA51828218	215,00 €
● FA51828230	215,00 €
● FA51828233	215,00 €
● FA51828256	200,00 €

3000K



○ FA51808301	215,00 €
● FA51808306	215,00 €
● FA51808312	215,00 €
● FA51808318	215,00 €
● FA51808330	215,00 €
● FA51808333	215,00 €
● FA51808356	200,00 €

4000K

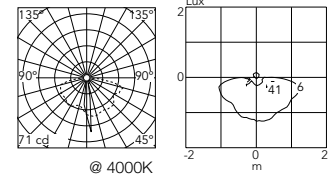



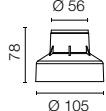

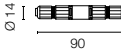



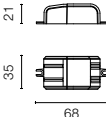

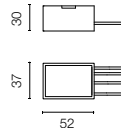
○ FA51808201	215,00 €
● FA51808206	215,00 €
● FA51808212	215,00 €
● FA51808218	215,00 €
● FA51808230	215,00 €
● FA51808233	215,00 €
● FA51808256	200,00 €

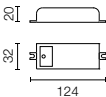

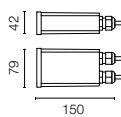
Gobi 65: Accessoires / Accessories

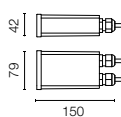
Boitier. ø105 H 78mm	Box for installation. ø105 H 78mm	F004Z0K0000	10,00 €		
Système de jonction IP68 à 2 voies 2 pôles. (Ø4÷6,9mm câble). Il ne peut pas être placé dans le boitier encastré pour l'installation.	2 way terminal block 2 poles IP68. (Ø4÷6,9mm cable). It can't be placed in the recessed box for installation.	F990C050000	34,00 €		

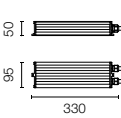
Gobi 65: Appareillages électriques / Drivers

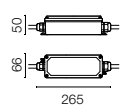
Source d'alimentation avec fonction dual Vout 24Vdc : 8W/100÷240V Iout 350ma: 6x1W/100÷240V IP20 Classe II Selv Eq.	Power supply dual function Vout 24Vdc: 8W/100÷240V Iout 350ma: 6x1W/100÷240V IP20 Class II Selv Eq.	*RF25754	36,00 €		
Équipement d'alimentation 24V 8W / 110-240V IP65 Classe II selv.	Power supply 24V 8W / 110-240V IP65 Class II selv.	*RF25748	63,00 €		
Équipement d'alimentation 24V 10W / 110-240V IP20 Classe II selv.	Power supply 24V 10W / 110-240V IP20 Class II selv.	*RF25747	48,00 €		
Équipement d'alimentation 24V 10W / 110-240V IP67 Classe II selv.	Power supply 24V 10W / 110-240V IP67 Class II selv.	*RF25757	86,00 €		
Équipement d'alimentation pour installation à distance 24Vdc 20W / 220-240V IP67 Classe II selv.	Power supply for remote installation 24Vdc 20W / 220-240V IP67 Class II selv.	*RF25752	133,00 €		
Équipement d'alimentation pour installation à distance 24Vdc 50W / 120-240V IP67 Classe II selv.	Power supply for remote installation 24Vdc 50W / 120-240V IP67 Class II selv.	*F990B28A000	251,00 €		
Équipement d'alimentation pour installation à distance 24Vdc 70W / 220-240V IP67 Classe II selv.	Power supply for remote installation 24Vdc 70W / 220-240V IP67 Class II selv.	*F990B27A000	212,00 €		

* Nombre maximum de luminaires par source d'alimentation / Maximum number of luminaires per power supply.

Nombre maximum de luminaires par source d'alimentation (220÷240 V). Ces données doivent être vérifiées en prenant en compte les conditions spécifiques d'installation.

Maximum number of luminaires per power supply. (220÷240 V). These data must be checked taking into account the specific installation conditions.

Acc. RF25754	1
Acc. RF25748	1
Acc. RF25747	2
Acc. RF25757	2

Acc. RF25752	3
Acc. F990B28A000	9
Acc. F990B27A000	17

Gobi 49 Mono

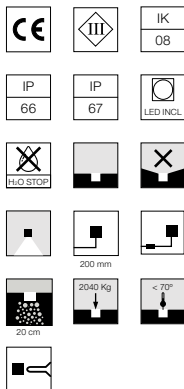
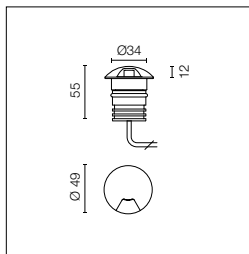

Source LED incluse. Source d'alimentation électrique à distance 24V dc à commander séparément. Boîte de dérivation nécessaire, à commander séparément. Équipé d'un câble sortant de 200 mm en néoprène, avec un système de connexion intégré H2O STOP et d'un kit avec des connecteurs sertissables et des gaines thermorétractables adhésives qui garantissent l'étanchéité de la connexion. Version avec intensité réglable disponible sur demande.

LED source included. 24V dc remote electric power supply to be ordered separately. Requires a junction box to be ordered separately. The luminaire is equipped with a protruding, 200 mm cable with an integrated H2O STOP connection system and a wiring kit with crimp connectors and adhesive heat-shrink tubing guaranteeing the water tightness of the connection. Adjustable light intensity version available upon request.

2200K disponible sur demande.

2200K available on request.

Power Led: 2,3W - 139 lm ≠ OUTPUT 10 lm - 2700K/CRI 80 -24Vdc / 2,3W - 149 lm ≠ OUTPUT 11 lm - 3000K/CRI 80 -24Vdc / 2,3W - 162 lm ≠ OUTPUT 12 lm - 4000K/CRI 80 -24Vdc

2700K

○ FA51702501	153,00 €
● FA51702506	153,00 €
● FA51702512	153,00 €
● FA51702518	153,00 €
● FA51702530	153,00 €
● FA51702533	153,00 €
● FA51702556	141,00 €

3000K

○ FA51702301	153,00 €
● FA51702306	153,00 €
● FA51702312	153,00 €
● FA51702318	153,00 €
● FA51702330	153,00 €
● FA51702333	153,00 €
● FA51702356	141,00 €

4000K

○ FA51702201	153,00 €
● FA51702206	153,00 €
● FA51702212	153,00 €
● FA51702218	153,00 €
● FA51702230	153,00 €
● FA51702233	153,00 €
● FA51702256	141,00 €

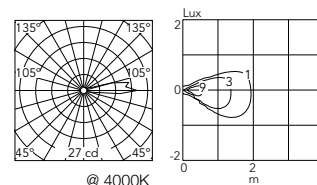

Gobi 49 Double

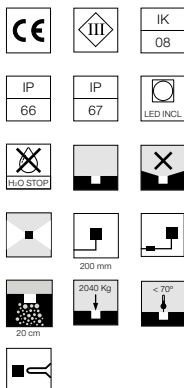
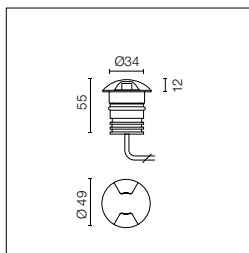

Source LED incluse. Source d'alimentation électrique à distance 24V dc à commander séparément. Boîte de dérivation nécessaire, à commander séparément. Équipé d'un câble sortant de 200 mm en néoprène, avec un système de connexion intégré H2O STOP et d'un kit avec des connecteurs sertissables et des gaines thermorétractables adhésives qui garantissent l'étanchéité de la connexion. Version avec intensité réglable disponible sur demande.

LED source included. 24V dc remote electric power supply to be ordered separately. Requires a junction box to be ordered separately. The luminaire is equipped with a protruding, 200 mm cable with an integrated H2O STOP connection system and a wiring kit with crimp connectors and adhesive heat-shrink tubing guaranteeing the water tightness of the connection. Adjustable light intensity version available upon request.

2200K disponible sur demande.

2200K available on request.

Power Led: 2,3W - 2x139 lm ≠ OUTPUT 2x10 lm - 2700K/CRI 80 -24Vdc / 2,3W - 2x149 lm ≠ OUTPUT 2x11 lm - 3000K/CRI 80 -24Vdc / 2,3W - 2x162 lm ≠ OUTPUT 2x12 lm - 4000K/CRI 80 -24Vdc

2700K

○ FA51703501	155,00 €
● FA51703506	155,00 €
● FA51703512	155,00 €
● FA51703518	155,00 €
● FA51703530	155,00 €
● FA51703533	155,00 €
● FA51703556	143,00 €

3000K

○ FA51703301	155,00 €
● FA51703306	155,00 €
● FA51703312	155,00 €
● FA51703318	155,00 €
● FA51703330	155,00 €
● FA51703333	155,00 €
● FA51703356	143,00 €

4000K

○ FA51703201	155,00 €
● FA51703206	155,00 €
● FA51703212	155,00 €
● FA51703218	155,00 €
● FA51703230	155,00 €
● FA51703233	155,00 €
● FA51703256	143,00 €

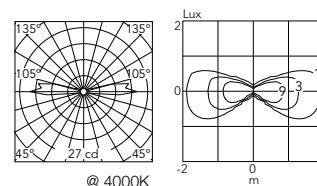

Gobi 49 Triple

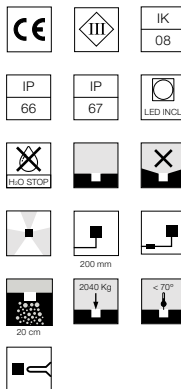
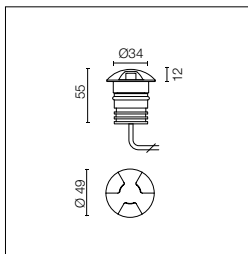

Source LED incluse. Source d'alimentation électrique à distance 24V dc à commander séparément. Boîte de dérivation nécessaire, à commander séparément. Équipé d'un câble sortant de 200 mm en néoprène, avec un système de connexion intégré H2O STOP et d'un kit avec des connecteurs sertissables et des gaines thermorétractables adhésives qui garantissent l'étanchéité de la connexion. Version avec intensité réglable disponible sur demande.

LED source included. 24V dc remote electric power supply to be ordered separately. Requires a junction box to be ordered separately. The luminaire is equipped with a protruding, 200 mm cable with an integrated H2O STOP connection system and a wiring kit with crimp connectors and adhesive heat-shrink tubing guaranteeing the water tightness of the connection. Adjustable light intensity version available upon request.

2200K disponible sur demande.

2200K available on request.

Power Led: 2,3W - 3x139 lm ≠ OUTPUT 3x10 lm - 2700K/CRI 80 -24Vdc / 2,3W - 3x149 lm ≠ OUTPUT 3x11 lm - 3000K/CRI 80 -24Vdc / 2,3W - 3x162 lm ≠ OUTPUT 3x12 lm - 4000K/CRI 80 -24Vdc

2700K

○ FA51704501	155,00 €
● FA51704506	155,00 €
● FA51704512	155,00 €
● FA51704518	155,00 €
● FA51704530	155,00 €
● FA51704533	155,00 €
● FA51704556	143,00 €

3000K

○ FA51704301	155,00 €
● FA51704306	155,00 €
● FA51704312	155,00 €
● FA51704318	155,00 €
● FA51704330	155,00 €
● FA51704333	155,00 €
● FA51704356	143,00 €

4000K

○ FA51704201	155,00 €
● FA51704206	155,00 €
● FA51704212	155,00 €
● FA51704218	155,00 €
● FA51704230	155,00 €
● FA51704233	155,00 €
● FA51704256	143,00 €

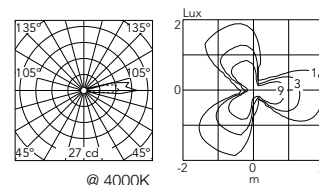

Gobi 49 Multi

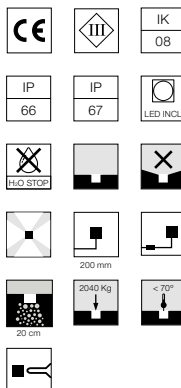
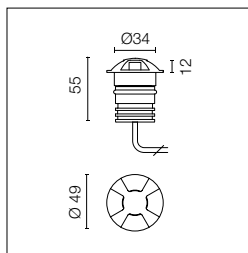

Source LED incluse. Source d'alimentation électrique à distance 24V dc à commander séparément. Boîte de dérivation nécessaire, à commander séparément. Équipé d'un câble sortant de 200 mm en néoprène, avec un système de connexion intégré H2O STOP et d'un kit avec des connecteurs sertissables et des gaines thermorétractables adhésives qui garantissent l'étanchéité de la connexion. Version avec intensité réglable disponible sur demande.

LED source included. 24V dc remote electric power supply to be ordered separately. Requires a junction box to be ordered separately. The luminaire is equipped with a protruding, 200 mm cable with an integrated H2O STOP connection system and a wiring kit with crimp connectors and adhesive heat-shrink tubing guaranteeing the water tightness of the connection. Adjustable light intensity version available upon request.

2200K disponible sur demande.

2200K available on request.

Power Led: 2,3W - 4x139 lm ≠ OUTPUT 4x10 lm - 2700K/CRI 80 -24Vdc / 2,3W - 4x149 lm ≠ OUTPUT 4x11 lm - 3000K/CRI 80 -24Vdc / 2,3W - 4x162 lm ≠ OUTPUT 4x12 lm - 4000K/CRI 80 -24Vdc

2700K

○ FA51705501	155,00 €
● FA51705506	155,00 €
● FA51705512	155,00 €
● FA51705518	155,00 €
● FA51705530	155,00 €
● FA51705533	155,00 €
● FA51705556	143,00 €

3000K

○ FA51705301	155,00 €
● FA51705306	155,00 €
● FA51705312	155,00 €
● FA51705318	155,00 €
● FA51705330	155,00 €
● FA51705333	155,00 €
● FA51705356	143,00 €

4000K

○ FA51705201	155,00 €
● FA51705206	155,00 €
● FA51705212	155,00 €
● FA51705218	155,00 €
● FA51705230	155,00 €
● FA51705233	155,00 €
● FA51705256	143,00 €

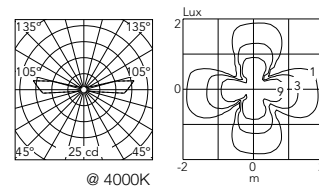

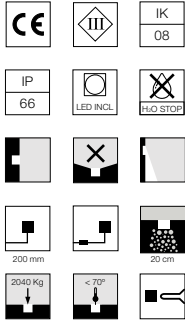
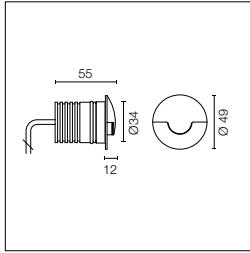

Source LED incluse. Source d'alimentation électrique à distance 24V dc à commander séparément. Boîte de dérivation nécessaire, à commander séparément. Équipé d'un câble sortant de 200 mm en néoprène, et d'un kit avec des connecteurs sertissables et des gaines thermorétractables adhésives qui garantissent l'étanchéité de la connexion. Version avec intensité réglable disponible sur demande.

LED source included. 24V dc remote electric power supply to be ordered separately. Requires a junction box to be ordered separately. The luminaire is equipped with a protruding, 200 mm cable and a wiring kit with crimp connectors and adhesive heat-shrink tubing guaranteeing the water tightness of the connection. Adjustable light intensity version available upon request.

2200K disponible sur demande.

2200K available on request.

Power Led: 2,3W - 139 lm ≠ OUTPUT 36 lm - 2700K/CRI 80 -24Vdc / 2,3W - 149 lm ≠ OUTPUT 39 lm - 3000K/CRI 80 -24Vdc / 2,3W - 162 lm ≠ OUTPUT 42 lm - 4000K/CRI 80 -24Vdc

2700K

○ FA51706501	153,00 €
● FA51706506	153,00 €
● FA51706512	153,00 €
● FA51706518	153,00 €
● FA51706530	153,00 €
● FA51706533	153,00 €
● FA51706556	141,00 €

3000K

○ FA51706301	153,00 €
● FA51706306	153,00 €
● FA51706312	153,00 €
● FA51706318	153,00 €
● FA51706330	153,00 €
● FA51706333	153,00 €
● FA51706356	141,00 €

4000K

○ FA51706201	153,00 €
● FA51706206	153,00 €
● FA51706212	153,00 €
● FA51706218	153,00 €
● FA51706230	153,00 €
● FA51706233	153,00 €
● FA51706256	141,00 €

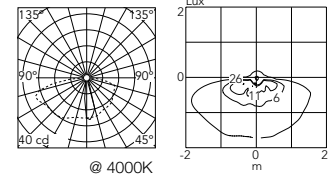

Gobi 49: Accessoires / Accessories

Boitier. ø105 H 78mm	Box for installation. ø105 H 78mm	F004Z0J0000	10,00 €		
Système de jonction IP68 à 2 voies 2 pôles. (Ø4÷6,9mm câble). Il ne peut pas être placé dans le boîtier encastré pour l'installation.	2 way terminal block 2 poles IP68. (Ø4÷6,9mm cable). It can't be placed in the recessed box for installation.	F990C050000	34,00 €		

Gobi 49: Appareillages électriques / Drivers

Source d'alimentation avec fonction dual Vout 24Vdc : 8W/100÷240V Iout 350ma: 6x1W/100÷240V IP20 Classe II Selv Eq.	Power supply dual function Vout 24Vdc: 8W/100÷240V Iout 350ma: 6x1W/100÷240V IP20 Class II Selv Eq.	*RF25754	36,00 €		
Équipement d'alimentation 24V 8W / 110-240V IP65 Classe II selv.	Power supply 24V 8W / 110-240V IP65 Class II selv.	*RF25748	63,00 €		
Équipement d'alimentation 24V 10W / 110-240V IP20 Classe II selv.	Power supply 24V 10W / 110-240V IP20 Class II selv.	*RF25747	48,00 €		
Équipement d'alimentation 24V 10W / 110-240V IP67 Classe II selv.	Power supply 24V 10W / 110-240V IP67 Class II selv.	*RF25757	86,00 €		
Équipement d'alimentation pour installation à distance 24Vdc 20W / 220-240V IP67 Classe II selv.	Power supply for remote installation 24Vdc 20W / 220-240V IP67 Class II selv.	*RF25752	133,00 €		
Équipement d'alimentation pour installation à distance 24Vdc 50W / 120-240V IP67 Classe II selv.	Power supply for remote installation 24Vdc 50W / 120-240V IP67 Class II selv.	*F990B28A000	251,00 €		
Équipement d'alimentation pour installation à distance 24Vdc 70W / 220-240V IP67 Classe II selv.	Power supply for remote installation 24Vdc 70W / 220-240V IP67 Class II selv.	*F990B27A000	212,00 €		

* Nombre maximum de luminaires par source d'alimentation / Maximum number of luminaires per power supply.

Nombre maximum de luminaires par source d'alimentation (220÷240 V). Ces données doivent être vérifiées en prenant en compte les conditions spécifiques d'installation.

Maximum number of luminaires per power supply. (220÷240 V). These data must be checked taking into account the specific installation conditions.

Acc. RF25754	1
Acc. RF25748	1
Acc. RF25747	4
Acc. RF25757	4

Acc. RF25752	5
Acc. F990B28A000	14
Acc. F990B27A000	29

C-Me



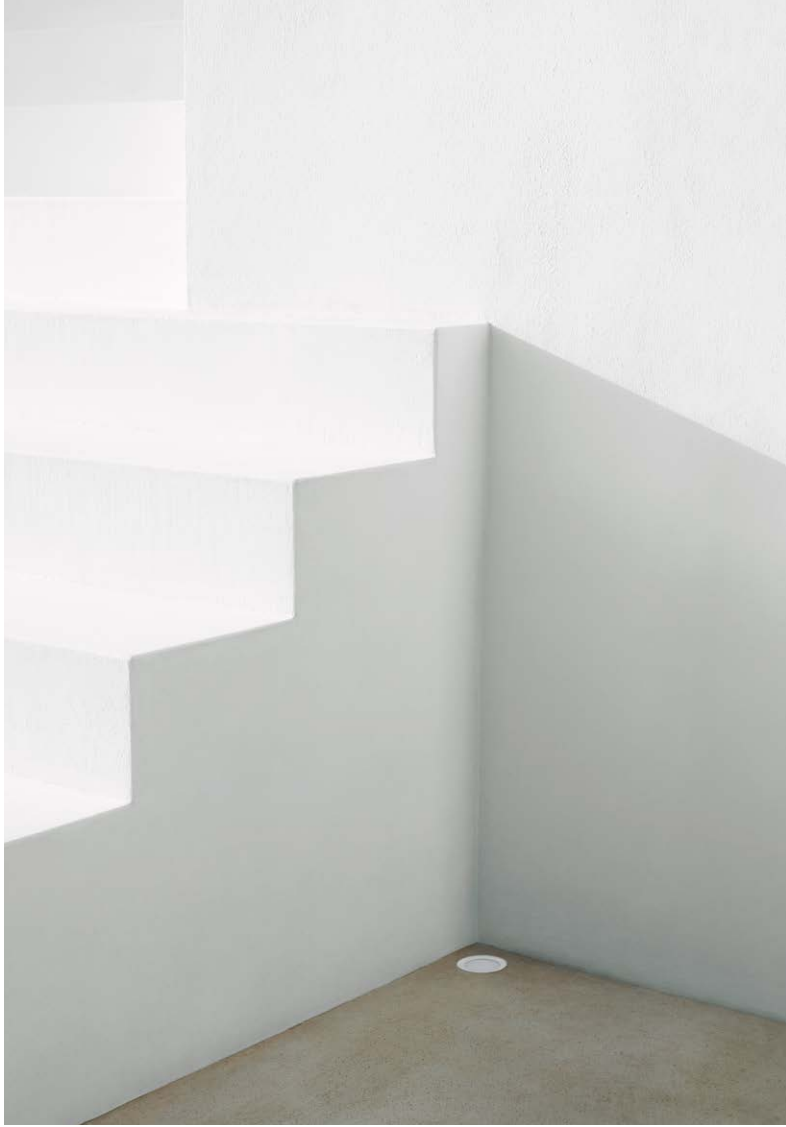

C-Me



Famille / Family

C-Me Round 40



Power Led

up to 2,3W
up to 111 lm - 2700K/CRI 80
up to 121 lm - 3000K/CRI 80
up to 125 lm - 4000K/CRI 80

* Net lumen output

2200K available on request.

C-Me Round 70



Power Led

up to 5,9W
up to 359 lm - 2700K/CRI 80
up to 389 lm - 3000K/CRI 80
up to 404 lm - 4000K/CRI 80

* Net lumen output

2200K available on request.

RGB - Power Led

up to 3,4W
3CH x 350mA

C-Me Square 40



Power Led

up to 2,3W
up to 111 lm - 2700K/CRI 80
up to 121 lm - 3000K/CRI 80
up to 125 lm - 4000K/CRI 80

* Net lumen output

2200K available on request.

C-Me Square 70 / RGB



Power Led

up to 5,9W
up to 359 lm - 2700K/CRI 80
up to 389 lm - 3000K/CRI 80
up to 404 lm - 4000K/CRI 80

* Net lumen output

2200K available on request.

RGB - Power Led

up to 3,4W
3CH x 350mA

C-Me Opal Round 40



Mid - Power Led

up to 0,3W
up to 22 lm - 2700K/CRI 80
up to 23 lm - 3000K/CRI 80
up to 23 lm - 4000K/CRI 80

* Net lumen output

C-Me Opal Round 70 / RGB



Mid - Power Led

up to 0,8W
up to 80 lm - 2700K/CRI 80
up to 82 lm - 3000K/CRI 80
up to 83 lm - 4000K/CRI 80

* Net lumen output

RGB - Power Led

up to 3,4W
3CH x 350mA

C-Me Opal Square 40



Mid - Power Led

up to 0,3W
up to 22 lm - 2700K/CRI 80
up to 23 lm - 3000K/CRI 80
up to 23 lm - 4000K/CRI 80

* Net lumen output

C-Me Opal Square 70 / RGB



Mid - Power Led

up to 0,8W
up to 80 lm - 2700K/CRI 80
up to 82 lm - 3000K/CRI 80
up to 83 lm - 4000K/CRI 80

* Net lumen output

RGB - Power Led

up to 3,4W
3CH x 350mA

Famille de luminaires avec source LED, encastrables au sol et sur lesquels on peut marcher, ou encastrables au mur. Ils se caractérisent par leur installation au ras du sol sans dépassement et par l'absence de vis visibles. Disponibles en versions carrée et ronde, en plusieurs dimensions et avec différentes ouvertures du faisceau lumineux. Disponibles en version RGB pour créer des scénographies avec des lumières de différentes couleurs. L'installation nécessite une boîte encastrable, à commander séparément. Pour éviter la stagnation d'eau il est nécessaire d'isoler la partie inférieure de la boîte avec une couche de matériau drainant ou un autre système de drainage. Pour garantir l'étanchéité de la gaine il est conseillé d'utiliser des câbles électriques flexibles et spécifiques pour l'extérieur.

C-Me

Luminaire encastrable au sol et sur lequel on peut marcher, ou encastrable au mur. Disponible en deux formats (carré et rond) et en deux dimensions pour chaque format. Deux ouvertures du faisceau lumineux, précise et moyenne. La structure du luminaire et le dissipateur sont en aluminium moulé sous pression EN AB-47100 (à faible teneur en cuivre). Diffuseur en verre transparent avec un bord noir sérigraphié, fixé par un système d'encollage robotisé.

C-Me Opal

Luminaire encastrable au sol et sur lequel on peut marcher, ou encastrable au mur. Disponible en deux formats (carré et rond) et en deux dimensions pour chaque format. Ouverture du faisceau lumineux pour un éclairage diffus. La structure du luminaire et le dissipateur sont en aluminium moulé sous pression EN AB-47100 (à faible teneur en cuivre). Diffuseur en verre transparent, avec un bord blanc sérigraphié et, sous le verre, des incrustations de matériau pour la diffusion. Le verre est fixé par un système d'encollage robotisé Luminaire en 24V dc, nécessite une source d'alimentation à distance à commander séparément.

Family of ground recessed and walk-over, or wall recessed, luminaires with LED light source. The luminaires are characterized by an installation flush with the floor, with no visible screws. Available in square and round versions, of different dimensions and with different beam angles. Available in RGB version to create set designs using colored lights. The installation requires a recessed box to be ordered separately. To avoid water stagnation, it is necessary to insulate the lower part of the box with a layer of drainage material or other drainage system. In order to guarantee the preservation of the cable guide, it is recommended to use flexible electric cables specifically designed for outdoor use.

C-Me

Ground recessed and walk-over or wall recessed luminaire. Available in two formats (square and round) and two different dimensions for each format. Two beam angles: spot and medium. The structure and sink of the luminaire are made of EN AB-47100 die-cast aluminum (with low copper content). Transparent glass diffuser with black silkscreen border, fixed through a robotic gluing system.

C-Me Opal

Ground recessed and walk-over or wall recessed luminaire. Available in two versions (square and round) and two different dimensions for each version. Beam angle for a diffused light. The structure and sink of the luminaire are made of EN AB-47100 die-cast aluminum (with low copper content). Transparent glass diffuser with white silkscreen border. Material inserts for diffusion under the glass. The glass is fixed through a robotic gluing system. The 24V dc luminaire is powered by a remote power supply to be ordered separately.

C-Me Round 40

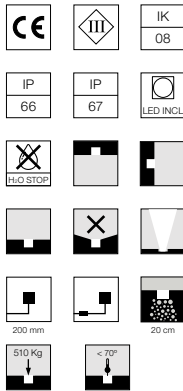
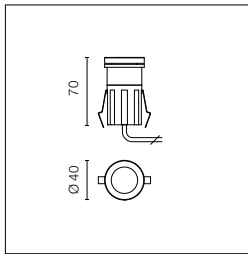

Source LED incluse. Source d'alimentation électrique à distance 24V dc, à commander séparément. Boîte de dérivation nécessaire, à commander séparément. Équipé d'un câble sortant de 200 mm en néoprène, et d'un kit avec des connecteurs sertissables et des gaines thermorétractables adhésives qui garantissent l'étanchéité de la connexion. Verre transparent extra-clair. Version avec intensité réglable disponible sur demande.

LED source included. 24V dc remote electric power supply to be ordered separately. Requires a junction box to be ordered separately. The luminaire is equipped with a protruding, neoprene, 200 mm cable and a wiring kit with crimp connectors and adhesive heat-shrink tubing guaranteeing the water tightness of the connection. Extra clear transparent glass. Adjustable light intensity version available upon request.

2200K disponible sur demande.

2200K available on request.

Optic Spot 10°

Power Led: 2,3W - 144 lm \neq OUTPUT 111 lm - 2700K/CRI 80 -24Vdc / 2,3W - 155 lm \neq OUTPUT 121 lm - 3000K/CRI 80 -24Vdc / 2,3W - 161 lm \neq OUTPUT 125 lm - 4000K/CRI 80 -24Vdc

2700K	3000K	4000K
FA10018112 172,00 €	FA10017612 172,00 €	FA10017712 172,00 €

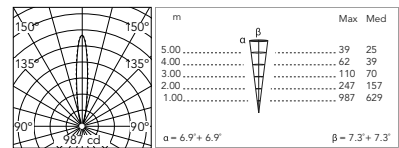

Optic Medium 45°

Power Led: 2,3W - 144 lm \neq OUTPUT 102 lm - 2700K/CRI 80 -24Vdc / 2,3W - 155 lm \neq OUTPUT 110 lm - 3000K/CRI 80 -24Vdc / 2,3W - 161 lm \neq OUTPUT 114 lm - 4000K/CRI 80 -24Vdc

2700K	3000K	4000K
FA10018140 172,00 €	FA10017640 172,00 €	FA10017740 172,00 €

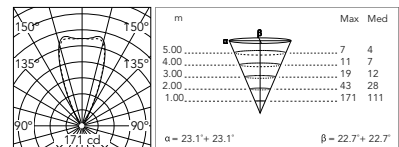

@ 3000K

@ 3000K

C-Me Opal Round 40

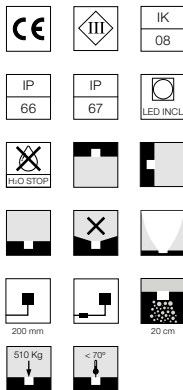
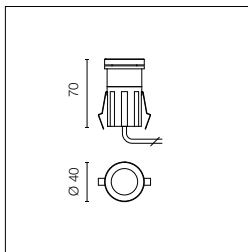

Source LED incluse. Source d'alimentation électrique à distance 24V dc, à commander séparément. Boîte de dérivation nécessaire, à commander séparément. Équipé d'un câble sortant de 200 mm en néoprène, et d'un kit avec des connecteurs sertissables et des gaines thermorétractables adhésives qui garantissent l'étanchéité de la connexion. Verre transparent extra-clair. Version avec intensité réglable disponible sur demande.

LED source included. 24V dc remote electric power supply to be ordered separately. Requires a junction box to be ordered separately. The luminaire is equipped with a protruding, neoprene, 200 mm cable and a wiring kit with crimp connectors and adhesive heat-shrink tubing guaranteeing the water tightness of the connection. Glass with opal diffuser. Adjustable light intensity.

2200K disponible sur demande.

2200K available on request.

Diffused Light

Mid-Power Led: 0,3W - 42 lm \neq OUTPUT 22 lm - 2700K/CRI 80 -24Vdc / 0,3W - 44 lm \neq OUTPUT 23 lm - 3000K/CRI 80 -24Vdc / 0,3W - 45 lm \neq OUTPUT 23 lm - 4000K/CRI 80 -24Vdc

2700K	3000K	4000K
FA100181118 172,00 €	FA100176118 172,00 €	FA100177118 172,00 €

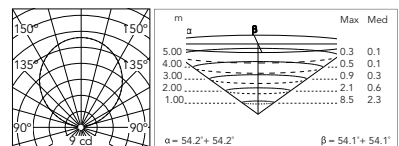

@ 3000K

* Nombre maximum de luminaires par source d'alimentation / Maximum number of luminaires per power supply.

Nombre maximum de luminaires par source d'alimentation (220-240 V). Ces données doivent être vérifiées en prenant en compte les conditions spécifiques d'installation.	Maximum number of luminaires per power supply. (220-240 V). These data must be checked taking into account the specific installation conditions.	Acc. RF25754	1	Acc. RF25752	5	Acc. F990B21A000	30
		Acc. RF25748	1	Acc. F990B28A000	14	Acc. RF26387.A	30
		Acc. RF25747	4	Acc. F990B27A000	29		
		Acc. RF25757	4	Acc. RF25750	30		

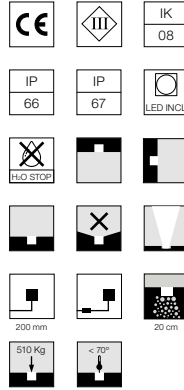
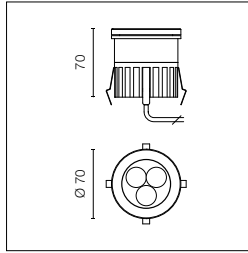

Source LED incluse. Source d'alimentation électrique à distance 24V dc à commander séparément. Boîte de dérivation nécessaire, à commander séparément. Équipé d'un câble sortant de 200 mm en néoprène, avec un système de connexion intégré H2O STOP, et d'un kit avec des connecteurs sertissables et des gaines thermorétractables adhésives qui garantissent l'étanchéité de la connexion. Verre transparent extra-clair. Version avec intensité réglable disponible sur demande.

LED source included. 24V dc remote electric power supply to be ordered separately. Requires a junction box to be ordered separately. The luminaire is equipped with a protruding, neoprene, 200 mm cable with an integrated H2O STOP connection system and a wiring kit with crimp connectors and adhesive heat-shrink tubing guaranteeing the water tightness of the connection. Extra clear transparent glass. Adjustable light intensity version available upon request.

2200K disponible sur demande.

2200K available on request.

Optic Spot 10°

Power Led: 5,9W - 431 lm ≠ OUTPUT 359 lm - 2700K/CRI 80 - 24Vdc / 5,9W - 466 lm ≠ OUTPUT 389 lm - 3000K/CRI 80 - 24Vdc / 5,9W - 484 lm ≠ OUTPUT 404 lm - 4000K/CRI 80 - 24Vdc

2700K		3000K		4000K	
FA10018212	279,00 €	FA10017912	279,00 €	FA10018012	279,00 €

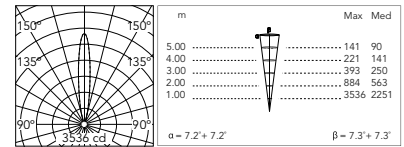

@ 3000K

Optic Medium 30°

Power Led: 5,9W - 431 lm ≠ OUTPUT 364 lm - 2700K/CRI 80 - 24Vdc / 5,9W - 466 lm ≠ OUTPUT 395 lm - 3000K/CRI 80 - 24Vdc / 5,9W - 484 lm ≠ OUTPUT 410 lm - 4000K/CRI 80 - 24Vdc

2700K		3000K		4000K	
FA10018230	279,00 €	FA10017930	279,00 €	FA10018030	279,00 €

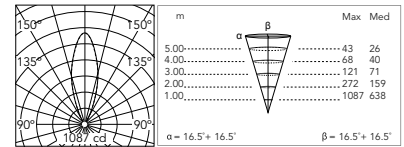

@ 3000K

Optic Flood 50°

Power Led: 5,9W - 431 lm ≠ OUTPUT 329 lm - 2700K/CRI 80 - 24Vdc / 5,9W - 466 lm ≠ OUTPUT 357 lm - 3000K/CRI 80 - 24Vdc / 5,9W - 484 lm ≠ OUTPUT 371 lm - 4000K/CRI 80 - 24Vdc

2700K		3000K		4000K	
FA10018240	279,00 €	FA10017940	279,00 €	FA10018040	279,00 €

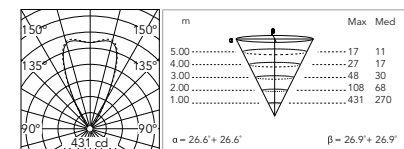

@ 3000K

C-Me Opal Round 70

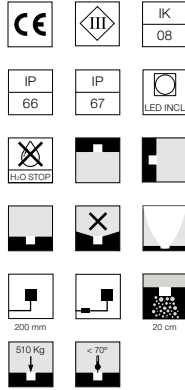
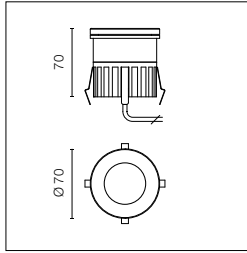

Source LED incluse. Source d'alimentation électrique à distance 24V dc à commander séparément. Boîte de dérivation nécessaire, à commander séparément. Équipé d'un câble sortant de 200 mm en néoprène, avec un système de connexion intégré H2O STOP, et d'un kit avec des connecteurs sertissables et des gaines thermorétractables adhésives qui garantissent l'étanchéité de la connexion. Verre avec diffuseur opale. Intensité réglable.

LED source included. 24V dc remote electric power supply to be ordered separately. Requires a junction box to be ordered separately. The luminaire is equipped with a protruding, neoprene, 200 mm cable with an integrated H2O STOP connection system and a wiring kit with crimp connectors and adhesive heat-shrink tubing guaranteeing the water tightness of the connection. Glass with opal diffuser. Adjustable light intensity.

2200K disponible sur demande.

2200K available on request.

Diffused Light

Mid-Power Led: 0,8W - 127 lm ≠ OUTPUT 80 lm - 2700K/CRI 80 - 24Vdc / 0,8W - 131 lm ≠ OUTPUT 82 lm - 3000K/CRI 80 - 24Vdc / 0,8W - 136 lm ≠ OUTPUT 83 lm - 4000K/CRI 80 - 24Vdc

2700K	3000K	4000K
FA100182122 279,00 €	FA100179122 279,00 €	FA100180122 279,00 €

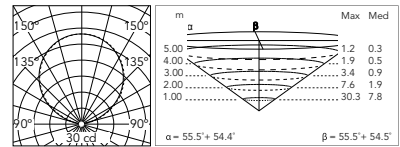

@ 3000K

* Nombre maximum de luminaires par source d'alimentation / Maximum number of luminaires per power supply.

Nombre maximum de luminaires par source d'alimentation (220-240 V). Ces données doivent être vérifiées en prenant en compte les conditions spécifiques d'installation.

Maximum number of luminaires per power supply. (220-240 V). These data must be checked taking into account the specific installation conditions.

Acc. RF25747	1	Acc. RF25750	10
Acc. RF25757	1	Acc. F990B21A000	10
Acc. RF25752	2	Acc. RF26387.A	10
Acc. F990B28A000	6		
Acc. F990B27A000	12		

C-Me Round 70 RGB

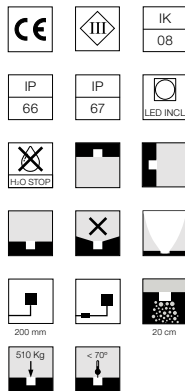
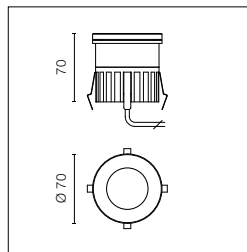

Source LED incluse. Source d'alimentation électrique à distance avec une interface DMX 3chx350mA à commander séparément. Boîte de dérivation nécessaire, à commander séparément. Équipé d'un câble sortant de 200 mm en néoprène, et d'un kit avec des connecteurs sertissables et des gaines thermorétractables adhésives qui garantissent l'étanchéité de la connexion. Verre transparent extra-clair.

LED source included. Remote electric power supply with DMX 3chx350mA interface, to be ordered separately. Requires a junction box to be ordered separately. The luminaire is equipped with a protruding, neoprene, 200 mm cable and a wiring kit with crimp connectors and adhesive heat-shrink tubing guaranteeing the water tightness of the connection. Extra clear transparent glass.

RGB Power Led: 3,4W - 3CH x 350mA

Optic Spot 10°

FA10017412 249,00 €

Optic Medium 35°

FA10017440 249,00 €

Schéma électrique et installation système RGB.

10 luminaires C-Me Round 70 LED RGB maximum pour chaque code F990B22A000.

Voir schéma électrique n.5 Page 832.

Wiring diagram and installation scheme RGB.

Max 10 luminaires C-Me Round 70 LED RGB for each code F990B22A000.

See Wiring Diagram n.5 Page 832.

Photometric data on request.

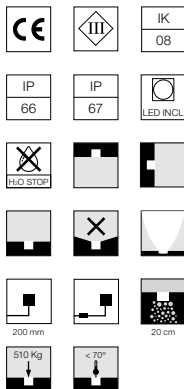
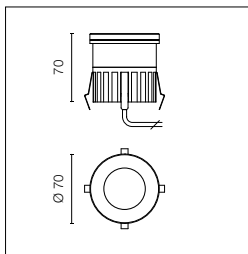

Source LED incluse. Source d'alimentation électrique à distance avec une interface DMX 3chx350mA à commander séparément. Boîte de dérivation nécessaire, à commander séparément. Équipé d'un câble sortant de 200 mm en néoprène, et d'un kit avec des connecteurs sertissables et des gaines thermorétractables adhésives qui garantissent l'étanchéité de la connexion. Verre avec diffuseur opale.

LED source included. Remote electric power supply with DMX 3chx350mA interface, to be ordered separately. Requires a junction box to be ordered separately. The luminaire is equipped with a protruding, neoprene, 200 mm cable and a wiring kit with crimp connectors and adhesive heat-shrink tubing guaranteeing the water tightness of the connection. Glass with opal diffuser.

Schéma électrique et installation système RGB.

Wiring diagram and installation scheme RGB.

10 luminaires C-Me Opal Round 70 LED RGB maximum pour chaque code F990B22A000.

Max 10 luminaires C-Me Opal Round 70 LED RGB for each code F990B22A000.

Voir schéma électrique n.5 Page 832.

See Wiring Diagram n.5 Page 832.

Diffused Light

RGB Power Led: 3,4W - 3CH x 350mA

RGB

FA100174122 249,00 €

Photometric data on request.

* Nombre maximum de luminaires par source d'alimentation / Maximum number of luminaires per power supply.

Nombre maximum de luminaires par source d'alimentation (220÷240 V). Ces données doivent être vérifiées en prenant en compte les conditions spécifiques d'installation.

Maximum number of luminaires per power supply. (220÷240 V). These data must be checked taking into account the specific installation conditions.

Acc. F990B22A000 **10

**La tension entre les extrémités du système dépend du nombre de luminaires connectés en série. Veuillez vous en tenir à la norme CEI 64-8.

**The voltage at the end of the system depends on the number of fixtures connected in series, please comply with CEI 64-8 standards.

C-Me Square 40

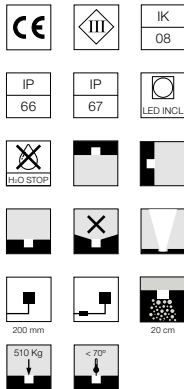
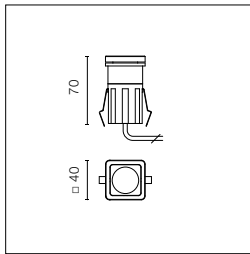

Source LED incluse. Source d'alimentation électrique à distance 24V dc, à commander séparément. Boîte de dérivation nécessaire, à commander séparément. Équipé d'un câble sortant de 200 mm en néoprène, et d'un kit avec des connecteurs sertissables et des gaines thermorétractables adhésives qui garantissent l'étanchéité de la connexion. Verre transparent extra-clair. Version avec intensité réglable disponible sur demande.

LED source included. 24V dc remote electric power supply to be ordered separately. Requires a junction box to be ordered separately. The luminaire is equipped with a protruding, neoprene, 200 mm cable and a wiring kit with crimp connectors and adhesive heat-shrink tubing guaranteeing the water tightness of the connection. Extra clear transparent glass. Adjustable light intensity version available upon request.

2200K disponible sur demande.

2200K available on request.

Optic Spot 10°

Power Led: 2,3W - 144 lm \neq OUTPUT 111 lm - 2700K/CRI 80 -24Vdc / 2,3W - 155 lm \neq OUTPUT 121 lm - 3000K/CRI 80 -24Vdc / 2,3W - 161 lm \neq OUTPUT 125 lm - 4000K/CRI 80 -24Vdc

2700K	3000K	4000K
FA100181133 172,00 €	FA100176133 172,00 €	FA100177133 172,00 €

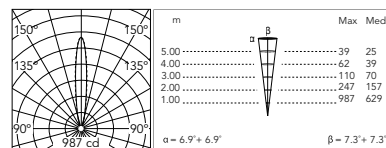

Optic Medium 45°

Power Led: 2,3W - 144 lm \neq OUTPUT 102 lm - 2700K/CRI 80 -24Vdc / 2,3W - 155 lm \neq OUTPUT 110 lm - 3000K/CRI 80 -24Vdc / 2,3W - 161 lm \neq OUTPUT 114 lm - 4000K/CRI 80 -24Vdc

2700K	3000K	4000K
FA100181141 172,00 €	FA10017641 172,00 €	FA10017741 172,00 €

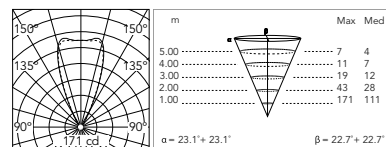

@ 3000K

@ 3000K

C-Me Opal Square 40

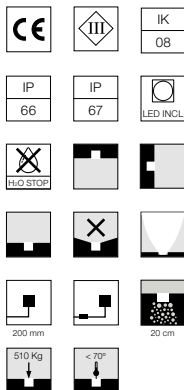
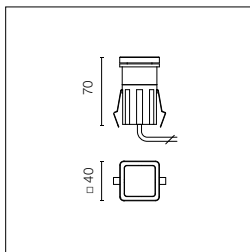

Source LED incluse. Source d'alimentation électrique à distance 24V dc, à commander séparément. Boîte de dérivation nécessaire, à commander séparément. Équipé d'un câble sortant de 200 mm en néoprène, et d'un kit avec des connecteurs sertissables et des gaines thermorétractables adhésives qui garantissent l'étanchéité de la connexion. Verre avec diffuseur opale. Intensité réglable.

LED source included. 24V dc remote electric power supply to be ordered separately. Requires a junction box to be ordered separately. The luminaire is equipped with a protruding, neoprene, 200 mm cable and a wiring kit with crimp connectors and adhesive heat-shrink tubing guaranteeing the water tightness of the connection. Glass with opal diffuser. Adjustable light intensity.

2200K disponible sur demande.

2200K available on request.

Diffused Light

Mid-Power Led: 0,3W - 42 lm \neq OUTPUT 22 lm - 2700K/CRI 80 -24Vdc / 0,3W - 44 lm \neq OUTPUT 23 lm - 3000K/CRI 80 -24Vdc / 0,3W - 45 lm \neq OUTPUT 23 lm - 4000K/CRI 80 -24Vdc

2700K	3000K	4000K
FA100181124 172,00 €	FA100176124 172,00 €	FA100177124 172,00 €

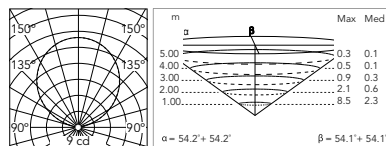

@ 3000K

* Nombre maximum de luminaires par source d'alimentation / Maximum number of luminaires per power supply.

Nombre maximum de luminaires par source d'alimentation (220-240 V). Ces données doivent être vérifiées en prenant en compte les conditions spécifiques d'installation.

Maximum number of luminaires per power supply. (220-240 V). These data must be checked taking into account the specific installation conditions.

Acc. RF25754	1	Acc. RF25752	5	Acc. F990B21A000	30
Acc. RF25748	1	Acc. F990B28A000	14	Acc. RF26387.A	30
Acc. RF25747	4	Acc. F990B27A000	29		
Acc. RF25757	4	Acc. RF25750	30		

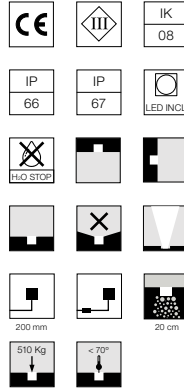
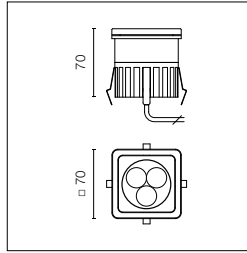

Source LED incluse. Source d'alimentation électrique à distance 24V dc à commander séparément. Boîte de dérivation nécessaire, à commander séparément. Équipé d'un câble sortant de 200 mm en néoprène, avec un système de connexion intégré H2O STOP, et d'un kit avec des connecteurs sertissables et des gaines thermorétractables adhésives qui garantissent l'étanchéité de la connexion.
Verre transparent extra-clair. Version avec intensité réglable disponible sur demande.

LED source included. 24V dc remote electric power supply to be ordered separately. Requires a junction box to be ordered separately. The luminaire is equipped with a protruding, neoprene, 200 mm cable with an integrated H2O STOP connection system and a wiring kit with crimp connectors and adhesive heat-shrink tubing guaranteeing the water tightness of the connection.
Extra clear transparent glass. Adjustable light intensity version available upon request.

2200K disponible sur demande.

2200K available on request.

Optic Spot 10°

Power Led: 5,9W - 431 lm ≠ OUTPUT 359 lm - 2700K/CRI 80 - 24Vdc / 5,9W - 466 lm ≠ OUTPUT 389 lm - 3000K/CRI 80 - 24Vdc / 5,9W - 484 lm ≠ OUTPUT 404 lm - 4000K/CRI 80 - 24Vdc

2700K		3000K		4000K	
FA100182132	279,00 €	FA100179132	279,00 €	FA100180132	279,00 €

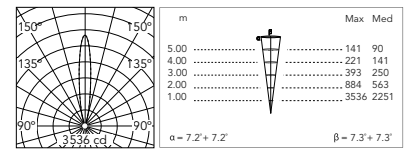

@ 3000K

Optic Medium 30°

Power Led: 5,9W - 431 lm ≠ OUTPUT 364 lm - 2700K/CRI 80 - 24Vdc / 5,9W - 466 lm ≠ OUTPUT 395 lm - 3000K/CRI 80 - 24Vdc / 5,9W - 484 lm ≠ OUTPUT 410 lm - 4000K/CRI 80 - 24Vdc

2700K		3000K		4000K	
FA100182130	279,00 €	FA100179130	279,00 €	FA100180130	279,00 €

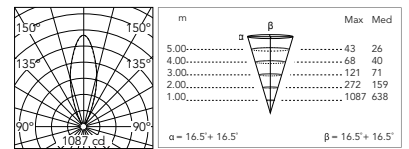

@ 3000K

Optic Flood 50°

Power Led: 5,9W - 431 lm ≠ OUTPUT 329 lm - 2700K/CRI 80 - 24Vdc / 5,9W - 466 lm ≠ OUTPUT 357 lm - 3000K/CRI 80 - 24Vdc / 5,9W - 484 lm ≠ OUTPUT 371 lm - 4000K/CRI 80 - 24Vdc

2700K		3000K		4000K	
FA10018241	279,00 €	FA10017941	279,00 €	FA10018041	279,00 €

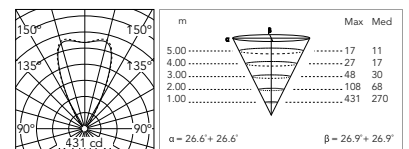

@ 3000K

C-Me Opal Square 70

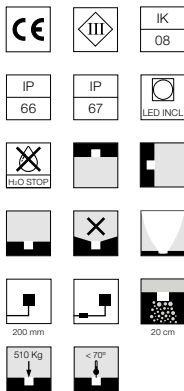
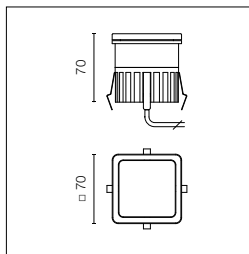

Source LED incluse. Source d'alimentation électrique à distance 24V dc à commander séparément. Boîte de dérivation nécessaire, à commander séparément. Équipé d'un câble sortant de 200 mm en néoprène, avec un système de connexion intégré H2O STOP, et d'un kit avec des connecteurs sertissables et des gaines thermorétractables adhésives qui garantissent l'étanchéité de la connexion. Verre avec diffuseur opale. Intensité réglable.

LED source included. 24V dc remote electric power supply to be ordered separately. Requires a junction box to be ordered separately. The luminaire is equipped with a protruding, neoprene, 200 mm cable with an integrated H2O STOP connection system and a wiring kit with crimp connectors and adhesive heat-shrink tubing guaranteeing the water tightness of the connection. Glass with opal diffuser. Adjustable light intensity.

2200K disponible sur demande.

2200K available on request.

Diffused Light

Mid-Power Led: 0,8W - 127 lm ≠ OUTPUT 80 lm - 2700K/CRI 80 - 24Vdc / 0,8W - 131 lm ≠ OUTPUT 82 lm - 3000K/CRI 80 - 24Vdc / 0,8W - 136 lm ≠ OUTPUT 83 lm - 4000K/CRI 80 - 24Vdc

2700K	3000K	4000K
FA100182125 279,00 €	FA100179125 279,00 €	FA100180125 279,00 €

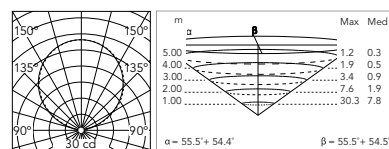

@ 3000K

* Nombre maximum de luminaires par source d'alimentation / Maximum number of luminaires per power supply.

Nombre maximum de luminaires par source d'alimentation (220÷240 V). Ces données doivent être vérifiées en prenant en compte les conditions spécifiques d'installation.

Maximum number of luminaires per power supply. (220÷240 V). These data must be checked taking into account the specific installation conditions.

Acc. RF25747	1	Acc. F990B28A000	6	Acc. F990B21A000	10
Acc. RF25757	1	Acc. F990B27A000	12	Acc. RF26387.A	10
Acc. RF25752	2	Acc. RF25750	10		

C-Me Square 70 RGB

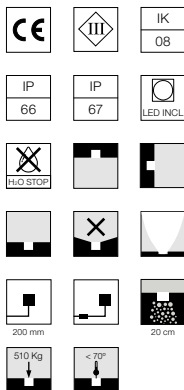
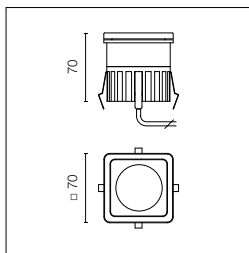

Source LED incluse. Source d'alimentation électrique à distance avec une interface DMX 3chx350mA à commander séparément. Boîte de dérivation nécessaire, à commander séparément. Équipé d'un câble sortant de 200 mm en néoprène, et d'un kit avec des connecteurs sertissables et des gaines thermorétractables adhésives qui garantissent l'étanchéité de la connexion. Verre transparent extra-clair.

LED source included. Remote electric power supply with DMX 3chx350mA interface, to be ordered separately. Requires a junction box to be ordered separately. The luminaire is equipped with a protruding, neoprene, 200 mm cable and a wiring kit with crimp connectors and adhesive heat-shrink tubing guaranteeing the water tightness of the connection. Extra clear transparent glass.

Schéma électrique et installation système RGB.

10 luminaires C-Me Square 70 LED RGB maximum pour chaque code F990B22A000.

Voir schéma électrique n.5 Page 832.

Wiring diagram and installation scheme RGB.

Max 10 luminaires C-Me Square 70 LED RGB for each code F990B22A000.

See Wiring Diagram n.5 Page 832.

RGB Power Led: 3,4W - 3CH x 350mA

Optic Spot 10°

FA100174132 249,00 €

Optic Medium 35°

FA10017441 249,00 €

Photometric data on request.

C-Me Opal Square 70 RGB

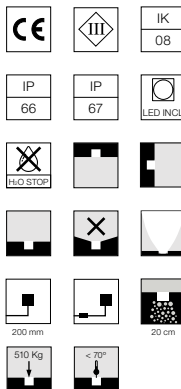
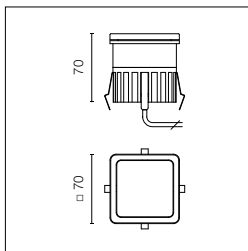

Source LED incluse. Source d'alimentation électrique à distance avec une interface DMX 3chx350mA à commander séparément. Boîte de dérivation nécessaire, à commander séparément. Équipé d'un câble sortant de 200 mm en néoprène, et d'un kit avec des connecteurs sertissables et des gaines thermorétractables adhésives qui garantissent l'étanchéité de la connexion.
Verre avec diffuseur opale.

LED source included. Remote electric power supply with DMX 3chx350mA interface, to be ordered separately. Requires a junction box to be ordered separately. The luminaire is equipped with a protruding, neoprene, 200 mm cable and a wiring kit with crimp connectors and adhesive heat-shrink tubing guaranteeing the water tightness of the connection.
Glass with opal diffuser.

Diffused Light

RGB Power Led: 3,4W - 3CH x 350mA

RGB

FA100174125 249,00 €

Photometric data on request.

Schéma électrique et installation système RGB.

10 luminaires C-Me Square 70 LED RGB maximum pour chaque code F990B22A000.

Voir schéma électrique n.5
Página 832.

Wiring diagram and installation scheme RGB.

Max 10 luminaires C-Me Opal Square 70 LED RGB for each code F990B22A000.

See Wiring Diagram n.5
Página 832.

* Nombre maximum de luminaires par source d'alimentation / Maximum number of luminaires per power supply.

Nombre maximum de luminaires par source d'alimentation (220÷240 V). Ces données doivent être vérifiées en prenant en compte les conditions spécifiques d'installation.







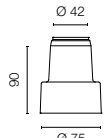

Maximum number of luminaires per power supply, (220÷240 V). These data must be checked taking into account the specific installation conditions.

Acc. F990B22A000 **10

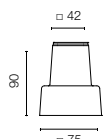

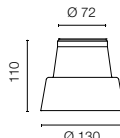

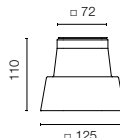

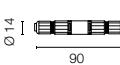



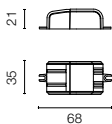

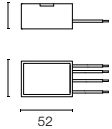

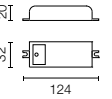

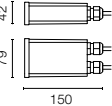

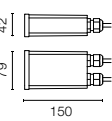

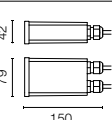
**La tension entre les extrémités du système dépend du nombre de luminaires connectés en série. Veuillez vous en tenir à la norme CEI 64-8.

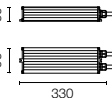
**The voltage at the end of the system depends on the number of fixtures connected in series, please comply with CEI 64-8 standards.

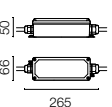
C-Me: Accessoires / Accessories

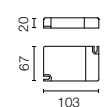
Boitier.	Box for installation.	C-Me Ø40 FA98	10,00 €		
Boitier.	Box for installation.	C-Me 40x40 FA99	10,00 €		
Boitier.	Box for installation.	C-Me Ø70 FA101	11,00 €		
Boitier.	Box for installation.	C-Me 70x70 FA102	11,00 €		
Système de jonction IP68 à 2 voies 2 pôles. (Ø4÷6,9mm câble). Il ne peut pas être placé dans le boitier encastré pour l'installation.	2 way terminal block 2 poles IP68. (Ø4÷6,9mm cable). It can't be placed in the recessed box for installation.	F990C050000	34,00 €		

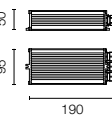
C-Me: Appareillages électriques / Drivers

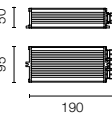
Source d'alimentation avec fonction dual Vout 24Vdc : 8W/100÷240V Iout 350ma: 6x1W/100÷240V IP20 Classe II Selv Eq.	Power supply dual function Vout 24Vdc: 8W/100÷240V Iout 350ma: 6x1W/100÷240V IP20 Class II Selv Eq.	C-Me 40mm *RF25754	36,00 €		
Équipement d'alimentation 24V 8W / 110-240V IP65 Classe II selv.	Power supply 24V 8W / 110-240V IP65 Class II selv.	C-Me 40mm *RF25748	63,00 €		
Équipement d'alimentation 24V 10W / 110-240V IP20 Classe II selv.	Power supply 24V 10W / 110-240V IP20 Class II selv.	*RF25747	48,00 €		
Équipement d'alimentation 24V 10W / 110-240V IP67 Classe II selv.	Power supply 24V 10W / 110-240V IP67 Class II selv.	*RF25757	86,00 €		
Équipement d'alimentation pour installation à distance 24Vdc 20W / 220-240V IP67 Classe II selv.	Power supply for remote installation 24Vdc 20W / 220-240V IP67 Class II selv.	*RF25752	133,00 €		
Alimentation 24Vdc 35W / 120-270V IP67 Class II selv.	Power supply 24Vdc 35W / 120-270V IP67 Class II selv.	F990B23AZ00	180,00 €		
Équipement d'alimentation 24Vdc 50W / 120-240V IP67 Classe II selv.	Power supply 24Vdc 50W / 120-240V IP67 Class II selv.	*F990B28A000	251,00 €		
Équipement d'alimentation 24Vdc 70W / 220-240V IP67 Classe II selv.	Power supply 24Vdc 70W / 220-240V IP67 Class II selv.	*F990B27A000	212,00 €		
Équipement d'alimentation pour installation à distance 24Vdc 17W / 110-240V (15W@110V) IP20 Classe II selv.	Power supply for remote installation 24Vdc 17W / 110-240V (15W@110V) IP20 Class II selv.	Diffused Light *RF25750  Dimmable Push-Dim Or 1-10V See Wiring Diagram n.4, Page 830	96,00 €		
Équipement d'alimentation 17W/110÷240V - 24Vdc (15W@110V) IP67 Classe II Selv.	Power supply 17W/110÷240V - 24Vdc (15W@110V) IP67 Class II Selv.	Diffused Light *F990B21A000  Dimmable Push-Dim Or 1-10V See Wiring Diagram n.4, Page 830	159,00 €		
Équipement d'alimentation pour installation à distance 24Vdc 20W / 110-240Vdc (15W@110V) IP67 Classe II selv.	Power supply for remote installation 24Vdc 20W / 110-240Vdc (15W@110V) IP67 Class II selv.	Diffused Light *RF26387.A  Dimmable DALI See Wiring Diagram n.4, Page 830	159,00 €		

C-Me RGB: Accessoires / Accessories

Contrôleur DMX pour boîtes encastrables. (60 mm d'entraxe)	DMX controller; dimmer switch for recessed box (60mm hole centres).	F990B10A000	1.006,00 €		
Contrôleur DMX. Interface stand/alone pc.	DMX controller; stand-alone/pc interface.	F990B11A000	1.306,00 €		
DMX splitter 512- dispositif électronique pour régénérer le signal dmx monodirectionnel. 1 entrée et 7 sorties, 12-24 Vdc. Source d'alimentation non incluse.	DMX splitter 512 - electronic device to regenerate the monodirectional DMX signal 1 Input and 7 output, 12-24Vdc. Power supply not included.	F990B13A000	227,00 €		
Câble DMX blindé à impédance constante 110 Ohm.	DMX cable - shielded twisted pair with 110 Ohm constant impedance.	F990B12A000	19,00 €		

C-Me RGB: Appareillages électriques / Drivers

Source d'alimentation avec interface dmx pour luminaires RGB 36w/220÷240v-3ch x 350ma (3ch x 10 x 1w) réglage préalable dmx ip67 Classe I Selv Eq.	Power supply with DMX interface for RGB fixtures 36W/220÷240v-3CH x 350mA (3CH x 10 x 1W) DMX control allowed IP67 Class I Selv Eq.	*F990B22A000	246,00 €		
--	---	--------------	----------	--	--

Ingraze

Designed by Flos Outdoor

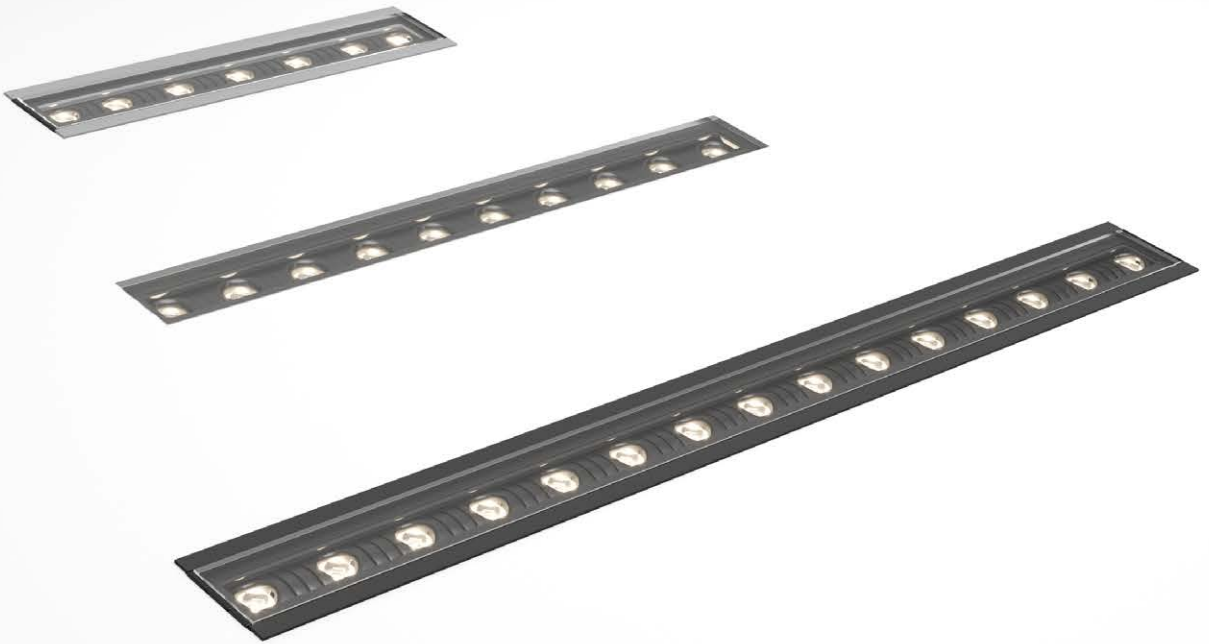





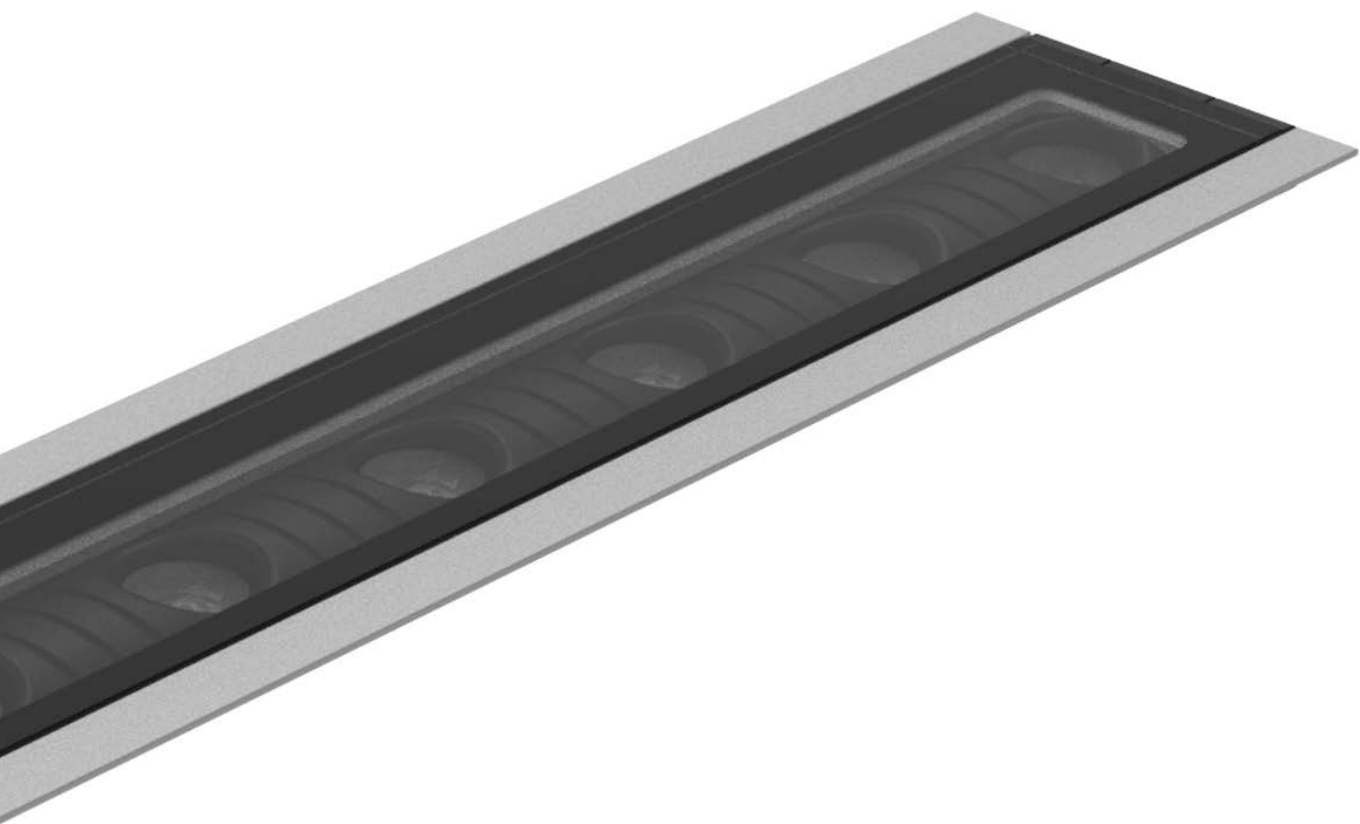



POLYVALENCE

La gamme de produits est proposée dans différentes configurations, avec ou sans cadre, avec des optiques fixes ou réglables. Un système de ressort breveté garantit une pureté esthétique optimale.

VERSATILITY

The range of products is offered in various frame and frameless configurations, with fixed or adjustable lenses. A patented system of springs guarantees the cleanest look.



CONFORT VISUEL

Le système optique innovant en retrait offre un confort visuel optimal quel que soit le contexte ; des accessoires spécifiques préinstallés, à lamelles longitudinales et asymétriques, permettent d'éviter l'éblouissement, même dans les situations les plus critiques.

VISUAL COMFORT

The innovative rear lens system offers optimal visual comfort in any situation; special asymmetrical or lengthwise diffuser accessories pre-installed allow to reduce the beam of light and to prevent glare in more critical situations too.

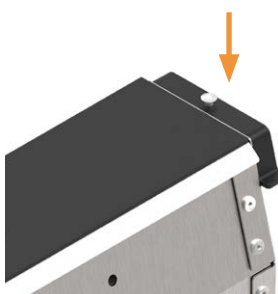

ANTIVOL

Le système de fixation antivol, spécialement conçu pour éviter les altérations et actes de vandalisme, permet également à Ingraze d'être utilisé dans des installations publiques.

ANTI-THEFT

An anti-theft fastening system specifically designed to prevent tampering and vandalism makes Ingraze suitable for public installations too.



FLEXIBILITÉ

Ingraze élargit sa gamme de projecteurs linéaires avec un programme avancé de spots encastrés au sol, adaptés à tous les types de projets grâce aux multiples possibilités d'installation.

FLEXIBILITY

Ingraze extends the range of linear spotlights with an advanced programme of recessed floor fittings, suitable for any type of project thanks to the many installation options.

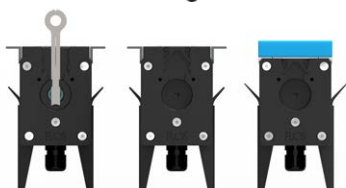

RANGÉE CONTINUE

La flexibilité d'installation dans tous les environnements est assurée par les différentes configurations, qu'elles soient individuelles ou en rangée continue, tout en maintenant l'homogénéité du faisceau lumineux.

CONTINUOUS LINE

Flexible installation in all areas is guaranteed by the various configurations, both single and in a continuous line, while keeping a consistent beam of light.



Famille / Family

Ingraze Fixed L 400

Frame / Linear Louvre / Asymmetric Louvre



Power Led

12,5W
Up to 958 lm - 2200K/CRI 80
Up to 993 lm - 2700K/CRI 80
Up to 1064 lm - 3000K/CRI 80
Up to 1100 lm - 4000K/CRI 80

Frameless / Linear Louvre / Asymmetric Louvre



Power Led

12,5W
Up to 958 lm - 2200K/CRI 80
Up to 993 lm - 2700K/CRI 80
Up to 1064 lm - 3000K/CRI 80
Up to 1100 lm - 4000K/CRI 80

Ingraze Fixed L 600

Frame / Linear Louvre / Asymmetric Louvre



Power Led

17W
Up to 1368 lm - 2200K/CRI 80
Up to 1419 lm - 2700K/CRI 80
Up to 1520 lm - 3000K/CRI 80
Up to 1571 lm - 4000K/CRI 80

Frameless / Linear Louvre / Asymmetric Louvre



Power Led

17W
Up to 1368 lm - 2200K/CRI 80
Up to 1419 lm - 2700K/CRI 80
Up to 1520 lm - 3000K/CRI 80
Up to 1571 lm - 4000K/CRI 80

Ingraze Fixed L 900

Frame / Linear Louvre / Asymmetric Louvre



Power Led

26W
Up to 2052 lm - 2200K/CRI 80
Up to 2128 lm - 2700K/CRI 80
Up to 2280 lm - 3000K/CRI 80
Up to 2356 lm - 4000K/CRI 80

Frameless / Linear Louvre / Asymmetric Louvre



Power Led

26W
Up to 2052 lm - 2200K/CRI 80
Up to 2128 lm - 2700K/CRI 80
Up to 2280 lm - 3000K/CRI 80
Up to 2356 lm - 4000K/CRI 80

Ingraze Fixed L 1200

Frame / Linear Louvre / Asymmetric Louvre



Power Led

33,5W
Up to 2736 lm - 2200K/CRI 80
Up to 2837 lm - 2700K/CRI 80
Up to 3040 lm - 3000K/CRI 80
Up to 3141 lm - 4000K/CRI 80

Frameless / Linear Louvre / Asymmetric Louvre



Power Led

33,5W
Up to 2736 lm - 2200K/CRI 80
Up to 2837 lm - 2700K/CRI 80
Up to 3040 lm - 3000K/CRI 80
Up to 3141 lm - 4000K/CRI 80

Ingraze Adjustable L 400

Frame / Linear Louvre / Asymmetric Louvre



Power Led

12,5W

Up to 958 lm - 2200K/CRI 80

Up to 993 lm - 2700K/CRI 80

Up to 1064 lm - 3000K/CRI 80

Up to 1100 lm - 4000K/CRI 80

Frameless / Linear Louvre / Asymmetric Louvre



Power Led

12,5W

Up to 958 lm - 2200K/CRI 80

Up to 993 lm - 2700K/CRI 80

Up to 1064 lm - 3000K/CRI 80

Up to 1100 lm - 4000K/CRI 80

Ingraze Adjustable L 600

Frame / Linear Louvre / Asymmetric Louvre



Power Led

17W

Up to 1368 lm - 2200K/CRI 80

Up to 1419 lm - 2700K/CRI 80

Up to 1520 lm - 3000K/CRI 80

Up to 1571 lm - 4000K/CRI 80

Frameless / Linear Louvre / Asymmetric Louvre



Power Led

17W

Up to 1368 lm - 2200K/CRI 80

Up to 1419 lm - 2700K/CRI 80

Up to 1520 lm - 3000K/CRI 80

Up to 1571 lm - 4000K/CRI 80

Ingraze Adjustable L 900

Frame / Linear Louvre / Asymmetric Louvre



Power Led

26W

Up to 2052 lm - 2200K/CRI 80

Up to 2128 lm - 2700K/CRI 80

Up to 2280 lm - 3000K/CRI 80

Up to 2356 lm - 4000K/CRI 80

Frameless / Linear Louvre / Asymmetric Louvre



Power Led

26W

Up to 2052 lm - 2200K/CRI 80

Up to 2128 lm - 2700K/CRI 80

Up to 2280 lm - 3000K/CRI 80

Up to 2356 lm - 4000K/CRI 80

Ingraze Adjustable L 1200

Frame / Linear Louvre / Asymmetric Louvre



Power Led

33,5W

Up to 2736 lm - 2200K/CRI 80

Up to 2837 lm - 2700K/CRI 80

Up to 3040 lm - 3000K/CRI 80

Up to 3141 lm - 4000K/CRI 80

Frameless / Linear Louvre / Asymmetric Louvre



Power Led

33,5W

Up to 2736 lm - 2200K/CRI 80

Up to 2837 lm - 2700K/CRI 80

Up to 3040 lm - 3000K/CRI 80

Up to 3141 lm - 4000K/CRI 80

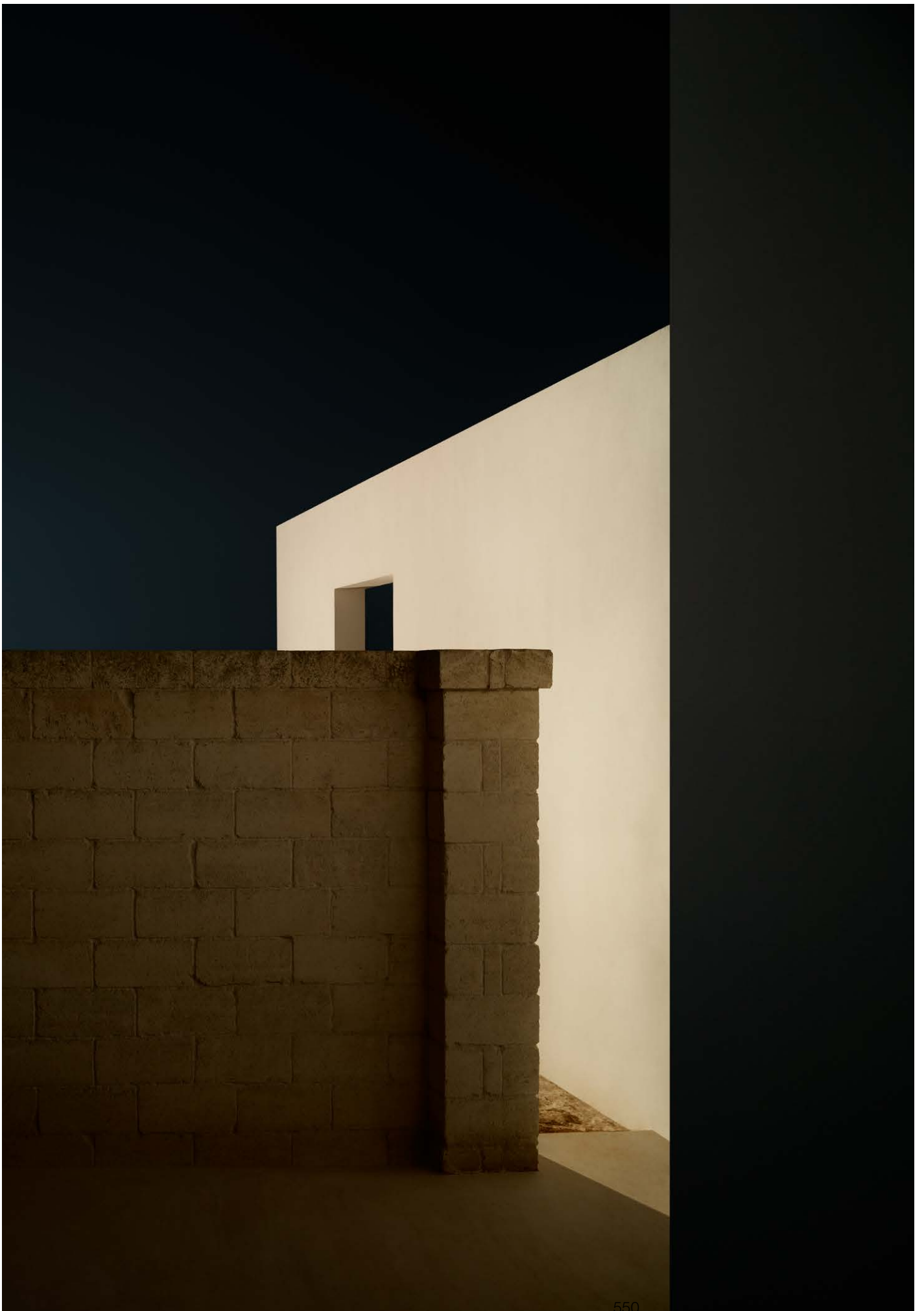

Description / Description

Luminaire linéaire d'extérieur pour installation encastrée au sol avec source LED haute puissance de dernière génération. Le produit est conçu pour garantir un confort visuel extrême grâce à la position en retrait du bloc optique; la gamme se décline en deux modèles, avec et sans cadre, disponibles en 4 longueurs pour garantir une flexibilité d'installation maximale et répondre aux différentes exigences de conception, grâce aux différentes configurations optiques : spot, medium, flood et elliptique. Des versions alternatives équipées de lamelles longitudinales et asymétriques permettent d'optimiser les performances du produit tout en garantissant un confort visuel maximal. Corps en aluminium extrudé soumis à un traitement de conversion chimique en surface pour une haute résistance à la corrosion. Double embout réalisé en technopolymère à haute résistance. Revêtement en poudre double couche et traitement marin « ACT » (Anti Corrosion Treatment) proposé sur demande, afin de garantir la résistance dans les environnements aux conditions climatiques difficiles. Le verre trempé extra-clair à indice de transmission élevé, siliconé au moyen d'un système de collage robotisé, après un traitement de nettoyage au plasma, garantit un degré de protection IP66/67, une résistance élevée aux chocs IK10, et peut supporter des charges allant jusqu'à 2500 kg. Ingraze se décline en version orientable sur l'axe vertical de +/-10°. Le réglage s'effectue de l'extérieur à l'aide d'un outil dédié fourni avec le produit, sans qu'il soit nécessaire d'ouvrir le produit pour accéder au bloc optique. Une échelle graduée sur le corps du produit assure une visée précise et sûre. Le dissipateur thermique interne breveté permet une excellente gestion de la température, augmentant ainsi les performances et la durée de vie du module LED. Températures de couleur disponibles : 2200, 2700, 3000 et 4000 K. Le contrôle de la lumière s'effectue via le protocole DALI, ou 1-10 V, avec driver intégré. Les deux versions, avec ou sans cadre, peuvent être installées dans le même coffrage, en acier INOX, en configuration simple ou en rangée continue. Les coffrages et les accessoires de montage doivent être commandés séparément. Un coffrage est disponible pour installer la version à fleur de sol. Un système de ressort breveté évite l'utilisation de vis visibles pour la fixation. L'appareil est précâblé avec des sections de câbles sortants et livré avec deux connecteurs à branchement rapide (IN-OUT) pour faciliter et accélérer les opérations de câblage électrique.

An outdoor strip device for recessed floor installation with a next-gen high-power LED source. The product is designed to guarantee extreme visual comfort thanks to the rear position of the lens unit; the range is organised into two models, either framed or frameless, available in 4 different lengths to guarantee the greatest installation flexibility and to meet different project requirements, thanks to the various lens configurations: spot, medium, flood and elliptical. The availability of alternative versions equipped with asymmetrical or lengthwise diffusers helps optimise the product's performance, guaranteeing maximum visual comfort. Extruded aluminium body with a chemical conversion coating for high corrosion-resistance. Double end-plate cover made from high-resistance technopolymer. Coating with a double layer of powder paint and marine "ACT" (Anti-Corrosion Treatment) upon request, which guarantees resistance under harsh environmental conditions. Extra-clear tempered glass with a high transmittance index, siliconised through an automated bonding system, having undergone plasma cleaning treatment, guarantees an IP66/67 protection rating, high resistance to IK10 impact and can be driven over by vehicles up to 2500kg. Ingraze is available in an adjustable version on the vertical axis by +/-10°. This adjustment is done from the outside using a special tool provided with the product, without the need to open the product to access the lens compartment. A graduated scale on the body of the product guarantees secure, precise positioning. The patented internal heat sink allows for excellent temperature management, increasing the performance and lifetime of the LED module. Available colour temperatures: 2200, 2700, 3000, and 4000K; the light can be controlled through the DALI protocol, or 1-10V, with a built-in driver. Both framed and frameless versions can be installed in the same installation box, made from INOX steel, in single or continuous line configurations. Installation box and assembly accessories should be ordered separately. Installation box is available for installation of the framed version flush with the floor. A patented system of springs avoids the use of visible screws for fastening. This device is pre-wired with outgoing cable sections and complete with two quick connectors (IN-OUT) to make electrical wiring quicker and easier.

Finitions / Colours

Ingraze



06 Grey



33 Anthracite

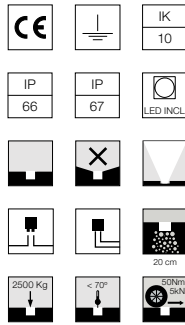
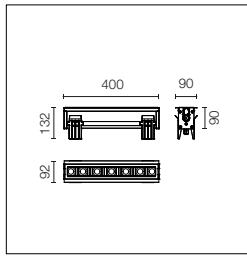

Source LED haute puissance incluse et optique en retrait.
Alimentation 220-240 V ON-OFF et variable 1-10 V et DALI.
Le coffrage d'installation obligatoire doit être commandé séparément.
Précâblé avec les connecteurs rapides H₂O Stop prise/fiche inclus.
ACT (Anti Corrosion Treatment) sur demande.

High-power LED source included and rear lenses. 1-10V or DALI on-off and dimmable 220-240V power supply.
Compulsory installation box to be ordered separately.
Pre-wired with H₂O Stop quick connectors, plug/socket included.
ACT (Anti-Corrosion Treatment) upon request.

Optic Spot 16°

Power Led: 12,5W - LED 1304 lm ≠ OUTPUT 958 lm - 2200K/CRI 80 / 12,5W - LED 1352 lm ≠ OUTPUT 993 lm - 2700K/CRI 80 / 12,5W - LED 1449 lm ≠ OUTPUT 1064 lm - 3000K/CRI 80 / 12,5W - LED 1497 lm ≠ OUTPUT 1100 lm - 4000K/CRI 80

2200K	2700K	3000K	4000K	
Non Dimmable	Non Dimmable	Non Dimmable	Non Dimmable	
● F017A1AA006	● F017A2AA006	● F017A3AA006	● F017A4AA006	620,00 €
● F017A1AA033	● F017A2AA033	● F017A3AA033	● F017A4AA033	620,00 €
1-10V	1-10V	1-10V	1-10V	
● F017A1AB006	● F017A2AB006	● F017A3AB006	● F017A4AB006	645,00 €
● F017A1AB033	● F017A2AB033	● F017A3AB033	● F017A4AB033	645,00 €
Dali	Dali	Dali	Dali	
● F017A1AD006	● F017A2AD006	● F017A3AD006	● F017A4AD006	657,00 €
● F017A1AD033	● F017A2AD033	● F017A3AD033	● F017A4AD033	657,00 €

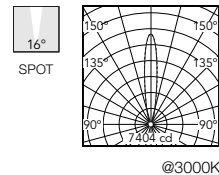

Optic Medium 25°

Power Led: 12,5W - LED 1304 lm ≠ OUTPUT 1031 lm - 2200K/CRI 80 / 12,5W - LED 1352 lm ≠ OUTPUT 1069 lm - 2700K/CRI 80 / 12,5W - LED 1449 lm ≠ OUTPUT 1146 lm - 3000K/CRI 80 / 12,5W - LED 1497 lm ≠ OUTPUT 1184 lm - 4000K/CRI 80

2200K	2700K	3000K	4000K	
Non Dimmable	Non Dimmable	Non Dimmable	Non Dimmable	
● F017A1BA006	● F017A2BA006	● F017A3BA006	● F017A4BA006	620,00 €
● F017A1BA033	● F017A2BA033	● F017A3BA033	● F017A4BA033	620,00 €
1-10V	1-10V	1-10V	1-10V	
● F017A1BB006	● F017A2BB006	● F017A3BB006	● F017A4BB006	645,00 €
● F017A1BB033	● F017A2BB033	● F017A3BB033	● F017A4BB033	645,00 €
Dali	Dali	Dali	Dali	
● F017A1BD006	● F017A2BD006	● F017A3BD006	● F017A4BD006	657,00 €
● F017A1BD033	● F017A2BD033	● F017A3BD033	● F017A4BD033	657,00 €

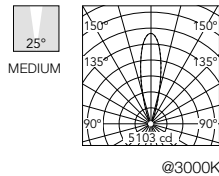

Optic Flood 46°

Power Led: 12,5W - LED 1304 lm ≠ OUTPUT 898 lm - 2200K/CRI 80 / 12,5W - LED 1352 lm ≠ OUTPUT 931 lm - 2700K/CRI 80 / 12,5W - LED 1449 lm ≠ OUTPUT 998 lm - 3000K/CRI 80 / 12,5W - LED 1497 lm ≠ OUTPUT 1031 lm - 4000K/CRI 80

2200K	2700K	3000K	4000K	
Non Dimmable	Non Dimmable	Non Dimmable	Non Dimmable	
● F017A1CA006	● F017A2CA006	● F017A3CA006	● F017A4CA006	620,00 €
● F017A1CA033	● F017A2CA033	● F017A3CA033	● F017A4CA033	620,00 €
1-10V	1-10V	1-10V	1-10V	
● F017A1CB006	● F017A2CB006	● F017A3CB006	● F017A4CB006	645,00 €
● F017A1CB033	● F017A2CB033	● F017A3CB033	● F017A4CB033	645,00 €
Dali	Dali	Dali	Dali	
● F017A1CD006	● F017A2CD006	● F017A3CD006	● F017A4CD006	657,00 €
● F017A1CD033	● F017A2CD033	● F017A3CD033	● F017A4CD033	657,00 €

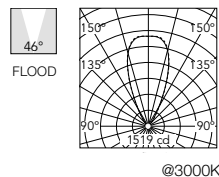

Optic Elliptical 12° x 50°

Power Led: 12,5W - LED 1304 lm ≠ OUTPUT 901 lm - 2200K/CRI 80 / 12,5W - LED 1352 lm ≠ OUTPUT 934 lm - 2700K/CRI 80 / 12,5W - LED 1449 lm ≠ OUTPUT 1001 lm - 3000K/CRI 80 / 12,5W - LED 1497 lm ≠ OUTPUT 1034 lm - 4000K/CRI 80

2200K	2700K	3000K	4000K	
Non Dimmable	Non Dimmable	Non Dimmable	Non Dimmable	
● F017A1DA006	● F017A2DA006	● F017A3DA006	● F017A4DA006	620,00 €
● F017A1DA033	● F017A2DA033	● F017A3DA033	● F017A4DA033	620,00 €
1-10V	1-10V	1-10V	1-10V	
● F017A1DB006	● F017A2DB006	● F017A3DB006	● F017A4DB006	645,00 €
● F017A1DB033	● F017A2DB033	● F017A3DB033	● F017A4DB033	645,00 €
Dali	Dali	Dali	Dali	
● F017A1DD006	● F017A2DD006	● F017A3DD006	● F017A4DD006	657,00 €
● F017A1DD033	● F017A2DD033	● F017A3DD033	● F017A4DD033	657,00 €

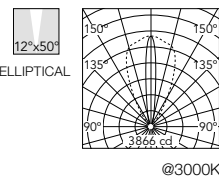

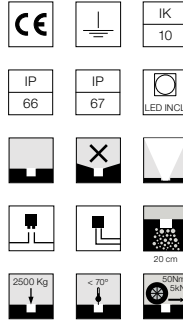
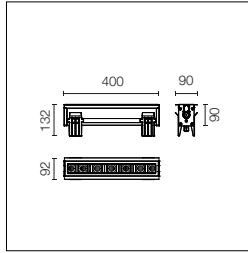

Source LED haute puissance incluse et optique en retrait équipée d'une grille à lamelles anti-éblouissement. Alimentation 220-240 V ON-OFF et variable 1-10 V et DALI. Le coffrage d'installation obligatoire doit être commandé séparément. Précâblé avec les connecteurs rapides H₂O Stop prise/fiche inclus. ACT (Anti Corrosion Treatment) sur demande.

High-power LED source included and rear lenses equipped with anti-glare diffuser grille. 1-10V or DALI on-off and dimmable 220-240V power supply. Compulsory installation box to be ordered separately. Pre-wired with H₂O Stop quick connectors, plug/socket included. ACT (Anti-Corrosion Treatment) upon request.

Optic Spot 16°

Power Led: 12,5W - LED 1304 lm ≠ OUTPUT 702 lm - 2200K/CRI 80 / 12,5W - LED 1352 lm ≠ OUTPUT 728 lm - 2700K/CRI 80 / 12,5W - LED 1449 lm ≠ OUTPUT 780 lm - 3000K/CRI 80 / 12,5W - LED 1497 lm ≠ OUTPUT 806 lm - 4000K/CRI 80

2200K	2700K	3000K	4000K	
Non Dimmable	Non Dimmable	Non Dimmable	Non Dimmable	
● F017A1HA006	● F017A2HA006	● F017A3HA006	● F017A4HA006	627,00 €
● F017A1JA033	● F017A2JA033	● F017A3JA033	● F017A4JA033	627,00 €
1-10V	1-10V	1-10V	1-10V	
● F017A1HB006	● F017A2HB006	● F017A3HB006	● F017A4HB006	652,00 €
● F017A1HB033	● F017A2HB033	● F017A3HB033	● F017A4HB033	652,00 €
Dali	Dali	Dali	Dali	
● F017A1HD006	● F017A2HD006	● F017A3HD006	● F017A4HD006	664,00 €
● F017A1HD033	● F017A2HD033	● F017A3HD033	● F017A4HD033	664,00 €

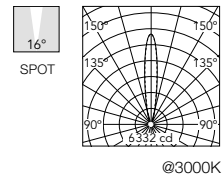

Beam Angle: 16°

h(m)	E(lx)	D(m)
1	6332	0.28
2	1583	0.56
3	704	0.83
4	396	1.11
5	253	1.39

Optic Medium 25°

Power Led: 12,5W - LED 1304 lm ≠ OUTPUT 744 lm - 2200K/CRI 80 / 12,5W - LED 1352 lm ≠ OUTPUT 772 lm - 2700K/CRI 80 / 12,5W - LED 1449 lm ≠ OUTPUT 827 lm - 3000K/CRI 80 / 12,5W - LED 1497 lm ≠ OUTPUT 854 lm - 4000K/CRI 80

2200K	2700K	3000K	4000K	
Non Dimmable	Non Dimmable	Non Dimmable	Non Dimmable	
● F017A1JA006	● F017A2JA006	● F017A3JA006	● F017A4JA006	627,00 €
● F017A1JA033	● F017A2JA033	● F017A3JA033	● F017A4JA033	627,00 €
1-10V	1-10V	1-10V	1-10V	
● F017A1JB006	● F017A2JB006	● F017A3JB006	● F017A4JB006	652,00 €
● F017A1JB033	● F017A2JB033	● F017A3JB033	● F017A4JB033	652,00 €
Dali	Dali	Dali	Dali	
● F017A1JD006	● F017A2JD006	● F017A3JD006	● F017A4JD006	664,00 €
● F017A1JD033	● F017A2JD033	● F017A3JD033	● F017A4JD033	664,00 €

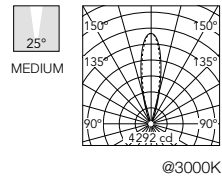

Beam Angle: 25°

h(m)	E(lx)	D(m)
1	4292	0.44
2	1073	0.87
3	477	1.31
4	268	1.74
5	172	2.18

Optic Flood 39°

Power Led: 12,5W - LED 1304 lm ≠ OUTPUT 576 lm - 2200K/CRI 80 / 12,5W - LED 1352 lm ≠ OUTPUT 597 lm - 2700K/CRI 80 / 12,5W - LED 1449 lm ≠ OUTPUT 639 lm - 3000K/CRI 80 / 12,5W - LED 1497 lm ≠ OUTPUT 661 lm - 4000K/CRI 80

2200K	2700K	3000K	4000K	
Non Dimmable	Non Dimmable	Non Dimmable	Non Dimmable	
● F017A1KA006	● F017A2KA006	● F017A3KA006	● F017A4KA006	627,00 €
● F017A1KA033	● F017A2KA033	● F017A3KA033	● F017A4KA033	627,00 €
1-10V	1-10V	1-10V	1-10V	
● F017A1KB006	● F017A2KB006	● F017A3KB006	● F017A4KB006	652,00 €
● F017A1KB033	● F017A2KB033	● F017A3KB033	● F017A4KB033	652,00 €
Dali	Dali	Dali	Dali	
● F017A1KD006	● F017A2KD006	● F017A3KD006	● F017A4KD006	664,00 €
● F017A1KD033	● F017A2KD033	● F017A3KD033	● F017A4KD033	664,00 €

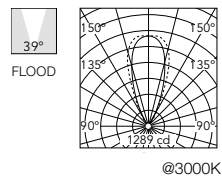

Beam Angle: 39°

h(m)	E(lx)	D(m)
1	1285	0.71
2	321	1.43
3	143	2.14
4	80	2.86
5	51	3.57

Optic Elliptical 13° x 40°

Power Led: 12,5W - LED 1304 lm ≠ OUTPUT 574 lm - 2200K/CRI 80 / 12,5W - LED 1352 lm ≠ OUTPUT 595 lm - 2700K/CRI 80 / 12,5W - LED 1449 lm ≠ OUTPUT 638 lm - 3000K/CRI 80 / 12,5W - LED 1497 lm ≠ OUTPUT 659 lm - 4000K/CRI 80

2200K	2700K	3000K	4000K	
Non Dimmable	Non Dimmable	Non Dimmable	Non Dimmable	
● F017A1LA006	● F017A2LA006	● F017A3LA006	● F017A4LA006	627,00 €
● F017A1LA033	● F017A2LA033	● F017A3LA033	● F017A4LA033	627,00 €
1-10V	1-10V	1-10V	1-10V	
● F017A1LB006	● F017A2LB006	● F017A3LB006	● F017A4LB006	652,00 €
● F017A1LB033	● F017A2LB033	● F017A3LB033	● F017A4LB033	652,00 €
Dali	Dali	Dali	Dali	
● F017A1LD006	● F017A2LD006	● F017A3LD006	● F017A4LD006	664,00 €
● F017A1LD033	● F017A2LD033	● F017A3LD033	● F017A4LD033	664,00 €

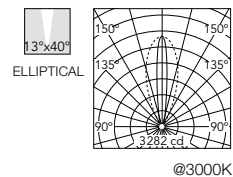

Beam Angle: 13°

h(m)	E(lx)	D(m)
1	3282	0.22
2	820	0.44
3	365	0.67
4	205	0.89
5	131	1.11

Ingraze Fixed Frame + Asymmetric Louvre L 400

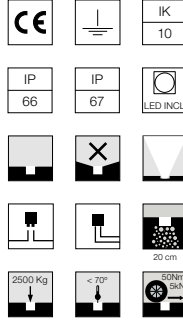
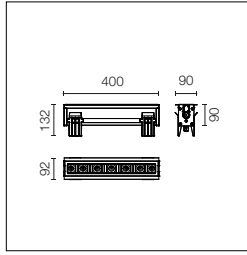

Source LED haute puissance incluse et optique en retrait équipée d'une grille à lamelles asymétrique anti-éblouissement. Alimentation 220-240 V ON-OFF et variable 1-10 V et DALI.
Le coffrage d'installation obligatoire doit être commandé séparément. Précâblé avec les connecteurs rapides H₂O Stop prise/fiche inclus. ACT (Anti Corrosion Treatment) sur demande.

High-power LED source included and rear lenses equipped with anti-glare asymmetrical diffuser grille. 1-10V or DALI on-off and dimmable 220-240V power supply. Compulsory installation box to be ordered separately. Pre-wired with H₂O Stop quick connectors, plug/socket included. ACT (Anti-Corrosion Treatment) upon request.

Optic Spot 15°

Power Led: 12,5W - LED 1304 lm ≠ OUTPUT 334 lm - 2200K/CRI 80 / 12,5W - LED 1352 lm ≠ OUTPUT 346 lm - 2700K/CRI 80 / 12,5W - LED 1449 lm ≠ OUTPUT 371 lm - 3000K/CRI 80 / 12,5W - LED 1497 lm ≠ OUTPUT 383 lm - 4000K/CRI 80

2200K	2700K	3000K	4000K	
Non Dimmable	Non Dimmable	Non Dimmable	Non Dimmable	
● F017A1QA006	● F017A2QA006	● F017A3QA006	● F017A4QA006	627,00 €
● F017A1QA033	● F017A2QA033	● F017A3QA033	● F017A4QA033	627,00 €
1-10V	1-10V	1-10V	1-10V	
● F017A1QB006	● F017A2QB006	● F017A3QB006	● F017A4QB006	652,00 €
● F017A1QB033	● F017A2QB033	● F017A3QB033	● F017A4QB033	652,00 €
Dali	Dali	Dali	Dali	
● F017A1QD006	● F017A2QD006	● F017A3QD006	● F017A4QD006	664,00 €
● F017A1QD033	● F017A2QD033	● F017A3QD033	● F017A4QD033	664,00 €

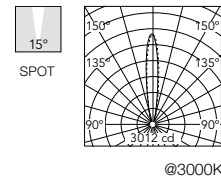

Optic Medium 25°

Power Led: 12,5W - LED 1304 lm ≠ OUTPUT 353 lm - 2200K/CRI 80 / 12,5W - LED 1352 lm ≠ OUTPUT 367 lm - 2700K/CRI 80 / 12,5W - LED 1449 lm ≠ OUTPUT 393 lm - 3000K/CRI 80 / 12,5W - LED 1497 lm ≠ OUTPUT 406 lm - 4000K/CRI 80

2200K	2700K	3000K	4000K	
Non Dimmable	Non Dimmable	Non Dimmable	Non Dimmable	
● F017A1RA006	● F017A2RA006	● F017A3RA006	● F017A4RA006	627,00 €
● F017A1RA033	● F017A2RA033	● F017A3RA033	● F017A4RA033	627,00 €
1-10V	1-10V	1-10V	1-10V	
● F017A1RB006	● F017A2RB006	● F017A3RB006	● F017A4RB006	652,00 €
● F017A1RB033	● F017A2RB033	● F017A3RB033	● F017A4RB033	652,00 €
Dali	Dali	Dali	Dali	
● F017A1RD006	● F017A2RD006	● F017A3RD006	● F017A4RD006	664,00 €
● F017A1RD033	● F017A2RD033	● F017A3RD033	● F017A4RD033	664,00 €

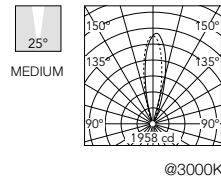

Optic Flood 42°

Power Led: 12,5W - LED 1304 lm ≠ OUTPUT 620 lm - 2200K/CRI 80 / 12,5W - LED 1352 lm ≠ OUTPUT 294 lm - 2700K/CRI 80 / 12,5W - LED 1449 lm ≠ OUTPUT 314 lm - 3000K/CRI 80 / 12,5W - LED 1497 lm ≠ OUTPUT 325 lm - 4000K/CRI 80

2200K	2700K	3000K	4000K	
Non Dimmable	Non Dimmable	Non Dimmable	Non Dimmable	
● F017A1SA006	● F017A2SA006	● F017A3SA006	● F017A4SA006	627,00 €
● F017A1SA033	● F017A2SA033	● F017A3SA033	● F017A4SA033	627,00 €
1-10V	1-10V	1-10V	1-10V	
● F017A1SB006	● F017A2SB006	● F017A3SB006	● F017A4SB006	652,00 €
● F017A1SB033	● F017A2SB033	● F017A3SB033	● F017A4SB033	652,00 €
Dali	Dali	Dali	Dali	
● F017A1SD006	● F017A2SD006	● F017A3SD006	● F017A4SD006	664,00 €
● F017A1SD033	● F017A2SD033	● F017A3SD033	● F017A4SD033	664,00 €

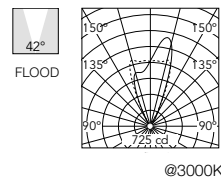

Optic Elliptical 12° x 40°

Power Led: 12,5W - LED 1304 lm ≠ OUTPUT 271 lm - 2200K/CRI 80 / 12,5W - LED 1352 lm ≠ OUTPUT 281 lm - 2700K/CRI 80 / 12,5W - LED 1449 lm ≠ OUTPUT 301 lm - 3000K/CRI 80 / 12,5W - LED 1497 lm ≠ OUTPUT 311 lm - 4000K/CRI 80

2200K	2700K	3000K	4000K	
Non Dimmable	Non Dimmable	Non Dimmable	Non Dimmable	
● F017A1TA006	● F017A2TA006	● F017A3TA006	● F017A4TA006	627,00 €
● F017A1TA033	● F017A2TA033	● F017A3TA033	● F017A4TA033	627,00 €
1-10V	1-10V	1-10V	1-10V	
● F017A1TB006	● F017A2TB006	● F017A3TB006	● F017A4TB006	652,00 €
● F017A1TB033	● F017A2TB033	● F017A3TB033	● F017A4TB033	652,00 €
Dali	Dali	Dali	Dali	
● F017A1TD006	● F017A2TD006	● F017A3TD006	● F017A4TD006	664,00 €
● F017A1TD033	● F017A2TD033	● F017A3TD033	● F017A4TD033	664,00 €

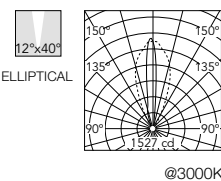

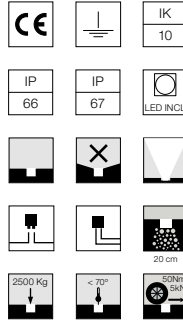
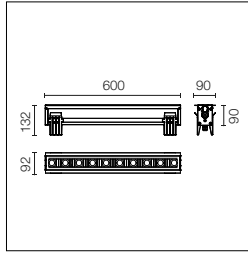

Source LED haute puissance incluse et optique en retrait.
Alimentation 220-240 V ON-OFF et variable 1-10 V et DALI.
Le coffrage d'installation obligatoire doit être commandé séparément.
Précâblé avec les connecteurs rapides H₂O Stop prise/fiche inclus.
ACT (Anti Corrosion Treatment) sur demande.

High-power LED source included and rear lenses. 1-10V or DALI on-off and dimmable 220-240V power supply.
Compulsory installation box to be ordered separately.
Pre-wired with H₂O Stop quick connectors, plug/socket included.
ACT (Anti-Corrosion Treatment) upon request.

Optic Spot 16°

Power Led: 17W - LED 1863 lm ≠ OUTPUT 1368 lm - 2200K/CRI 80 / 17W - LED 1932 lm ≠ OUTPUT 1419 lm - 2700K/CRI 80 / 17W - LED 2070 lm ≠ OUTPUT 1520 lm - 3000K/CRI 80 / 17W - LED 2139 lm ≠ OUTPUT 1571 lm - 4000K/CRI 80

2200K	2700K	3000K	4000K	
Non Dimmable	Non Dimmable	Non Dimmable	Non Dimmable	
● F017B1AA006	● F017B2AA006	● F017B3AA006	● F017B4AA006	800,00 €
● F017B1AA033	● F017B2AA033	● F017B3AA033	● F017B4AA033	800,00 €
1-10V	1-10V	1-10V	1-10V	
● F017B1AB006	● F017B2AB006	● F017B3AB006	● F017B4AB006	803,00 €
● F017B1AB033	● F017B2AB033	● F017B3AB033	● F017B4AB033	803,00 €
Dali	Dali	Dali	Dali	
● F017B1AD006	● F017B2AD006	● F017B3AD006	● F017B4AD006	847,00 €
● F017B1AD033	● F017B2AD033	● F017B3AD033	● F017B4AD033	847,00 €

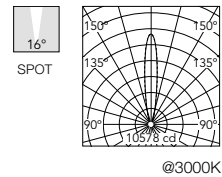

Beam Angle: 16°

h(m)	E(lx)	D(m)
1	10578	0.27
2	2644	0.55
3	1175	0.82
4	661	1.09
5	423	1.37

@3000K

Optic Medium 25°

Power Led: 17W - LED 1863 lm ≠ OUTPUT 1473 lm - 2200K/CRI 80 / 17W - LED 1932 lm ≠ OUTPUT 1527 lm - 2700K/CRI 80 / 17W - LED 2070 lm ≠ OUTPUT 1636 lm - 3000K/CRI 80 / 17W - LED 2139 lm ≠ OUTPUT 1691 lm - 4000K/CRI 80

2200K	2700K	3000K	4000K	
Non Dimmable	Non Dimmable	Non Dimmable	Non Dimmable	
● F017B1BA006	● F017B2BA006	● F017B3BA006	● F017B4BA006	800,00 €
● F017B1BA033	● F017B2BA033	● F017B3BA033	● F017B4BA033	800,00 €
1-10V	1-10V	1-10V	1-10V	
● F017B1BB006	● F017B2BB006	● F017B3BB006	● F017B4BB006	803,00 €
● F017B1BB033	● F017B2BB033	● F017B3BB033	● F017B4BB033	803,00 €
Dali	Dali	Dali	Dali	
● F017B1BD006	● F017B2BD006	● F017B3BD006	● F017B4BD006	847,00 €
● F017B1BD033	● F017B2BD033	● F017B3BD033	● F017B4BD033	847,00 €

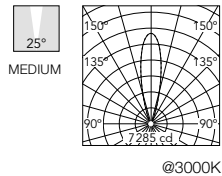

Beam Angle: 25°

h(m)	E(lx)	D(m)
1	7285	0.44
2	1821	0.88
3	809	1.32
4	455	1.76
5	291	2.20

@3000K

Optic Flood 46°

Power Led: 17W - LED 1863 lm ≠ OUTPUT 1283 lm - 2200K/CRI 80 / 17W - LED 1932 lm ≠ OUTPUT 1330 lm - 2700K/CRI 80 / 17W - LED 2070 lm ≠ OUTPUT 1425 lm - 3000K/CRI 80 / 17W - LED 2139 lm ≠ OUTPUT 1473 lm - 4000K/CRI 80

2200K	2700K	3000K	4000K	
Non Dimmable	Non Dimmable	Non Dimmable	Non Dimmable	
● F017B1CA006	● F017B2CA006	● F017B3CA006	● F017B4CA006	800,00 €
● F017B1CA033	● F017B2CA033	● F017B3CA033	● F017B4CA033	800,00 €
1-10V	1-10V	1-10V	1-10V	
● F017B1CB006	● F017B2CB006	● F017B3CB006	● F017B4CB006	803,00 €
● F017B1CB033	● F017B2CB033	● F017B3CB033	● F017B4CB033	803,00 €
Dali	Dali	Dali	Dali	
● F017B1CD006	● F017B2CD006	● F017B3CD006	● F017B4CD006	847,00 €
● F017B1CD033	● F017B2CD033	● F017B3CD033	● F017B4CD033	847,00 €

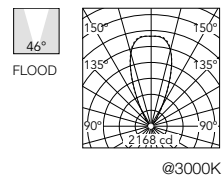

Beam Angle: 46°

h(m)	E(lx)	D(m)
1	2158	0.85
2	539	1.71
3	240	2.56
4	135	3.42
5	86	4.27

@3000K

Optic Elliptical 12° x 50°

Power Led: 17W - LED 1863 lm ≠ OUTPUT 1286 lm - 2200K/CRI 80 / 17W - LED 1932 lm ≠ OUTPUT 1334 lm - 2700K/CRI 80 / 17W - LED 2070 lm ≠ OUTPUT 1429 lm - 3000K/CRI 80 / 17W - LED 2139 lm ≠ OUTPUT 1477 lm - 4000K/CRI 80

2200K	2700K	3000K	4000K	
Non Dimmable	Non Dimmable	Non Dimmable	Non Dimmable	
● F017B1DA006	● F017B2DA006	● F017B3DA006	● F017B4DA006	800,00 €
● F017B1DA033	● F017B2DA033	● F017B3DA033	● F017B4DA033	800,00 €
1-10V	1-10V	1-10V	1-10V	
● F017B1DB006	● F017B2DB006	● F017B3DB006	● F017B4DB006	803,00 €
● F017B1DB033	● F017B2DB033	● F017B3DB033	● F017B4DB033	803,00 €
Dali	Dali	Dali	Dali	
● F017B1DD006	● F017B2DD006	● F017B3DD006	● F017B4DD006	847,00 €
● F017B1DD033	● F017B2DD033	● F017B3DD033	● F017B4DD033	847,00 €

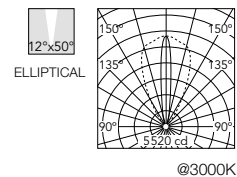

Beam Angle: 12°

h(m)	E(lx)	D(m)
1	5519	0.22
2	1380	0.44
3	613	0.66
4	345	0.87
5	221	1.09

@3000K

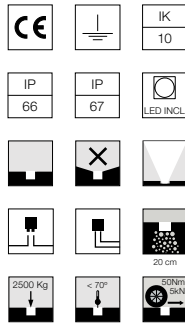
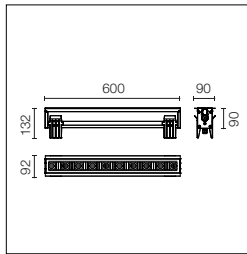

Source LED haute puissance incluse et optique en retrait équipée d'une grille à lamelles anti-éblouissement. Alimentation 220-240 V ON-OFF et variable 1-10 V et DALI. Le coffrage d'installation obligatoire doit être commandé séparément. Précâblé avec les connecteurs rapides H₂O Stop prise/fiche inclus. ACT (Anti Corrosion Treatment) sur demande.

High-power LED source included and rear lenses equipped with anti-glare diffuser grille. 1-10V or DALI on-off and dimmable 220-240V power supply. Compulsory installation box to be ordered separately. Pre-wired with H₂O Stop quick connectors, plug/socket included. ACT (Anti-Corrosion Treatment) upon request.

Optic Spot 16°

Power Led: 17W - LED 1863 lm ≠ OUTPUT 1003 lm - 2200K/CRI 80 / 17W - LED 1932 lm ≠ OUTPUT 1040 lm - 2700K/CRI 80 / 17W - LED 2070 lm ≠ OUTPUT 1115 lm - 3000K/CRI 80 / 17W - LED 2139 lm ≠ OUTPUT 1152 lm - 4000K/CRI 80

2200K	2700K	3000K	4000K	
Non Dimmable	Non Dimmable	Non Dimmable	Non Dimmable	
● F017B1HA006	● F017B2HA006	● F017B3HA006	● F017B4HA006	810,00 €
● F017B1HA033	● F017B2HA033	● F017B3HA033	● F017B4HA033	810,00 €
1-10V	1-10V	1-10V	1-10V	
● F017B1HB006	● F017B2HB006	● F017B3HB006	● F017B4HB006	813,00 €
● F017B1HB033	● F017B2HB033	● F017B3HB033	● F017B4HB033	813,00 €
Dali	Dali	Dali	Dali	
● F017B1HD006	● F017B2HD006	● F017B3HD006	● F017B4HD006	857,00 €
● F017B1HD033	● F017B2HD033	● F017B3HD033	● F017B4HD033	857,00 €

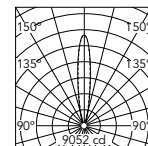

Beam Angle: 16°

h(m)	E(lx)	D(m)
1	9052	0.28
2	2263	0.56
3	1006	0.83
4	566	1.11
5	362	1.39

@3000K

Optic Medium 25°

Power Led: 17W - LED 1863 lm ≠ OUTPUT 1063 lm - 2200K/CRI 80 / 17W - LED 1932 lm ≠ OUTPUT 1102 lm - 2700K/CRI 80 / 17W - LED 2070 lm ≠ OUTPUT 1181 lm - 3000K/CRI 80 / 17W - LED 2139 lm ≠ OUTPUT 1220 lm - 4000K/CRI 80

2200K	2700K	3000K	4000K	
Non Dimmable	Non Dimmable	Non Dimmable	Non Dimmable	
● F017B1JA006	● F017B2JA006	● F017B3JA006	● F017B4JA006	810,00 €
● F017B1JA033	● F017B2JA033	● F017B3JA033	● F017B4JA033	810,00 €
1-10V	1-10V	1-10V	1-10V	
● F017B1JB006	● F017B2JB006	● F017B3JB006	● F017B4JB006	813,00 €
● F017B1JB033	● F017B2JB033	● F017B3JB033	● F017B4JB033	813,00 €
Dali	Dali	Dali	Dali	
● F017B1JD006	● F017B2JD006	● F017B3JD006	● F017B4JD006	857,00 €
● F017B1JD033	● F017B2JD033	● F017B3JD033	● F017B4JD033	857,00 €

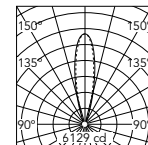

Beam Angle: 25°

h(m)	E(lx)	D(m)
1	6129	0.44
2	1532	0.87
3	681	1.31
4	383	1.74
5	245	2.18

@3000K

Optic Flood 39°

Power Led: 17W - LED 1863 lm ≠ OUTPUT 820 lm - 2200K/CRI 80 / 17W - LED 1932 lm ≠ OUTPUT 850 lm - 2700K/CRI 80 / 17W - LED 2070 lm ≠ OUTPUT 911 lm - 3000K/CRI 80 / 17W - LED 2139 lm ≠ OUTPUT 944 lm - 4000K/CRI 80

2200K	2700K	3000K	4000K	
Non Dimmable	Non Dimmable	Non Dimmable	Non Dimmable	
● F017B1KA006	● F017B2KA006	● F017B3KA006	● F017B4KA006	810,00 €
● F017B1KA033	● F017B2KA033	● F017B3KA033	● F017B4KA033	810,00 €
1-10V	1-10V	1-10V	1-10V	
● F017B1KB006	● F017B2KB006	● F017B3KB006	● F017B4KB006	813,00 €
● F017B1KB033	● F017B2KB033	● F017B3KB033	● F017B4KB033	813,00 €
Dali	Dali	Dali	Dali	
● F017B1KD006	● F017B2KD006	● F017B3KD006	● F017B4KD006	857,00 €
● F017B1KD033	● F017B2KD033	● F017B3KD033	● F017B4KD033	857,00 €

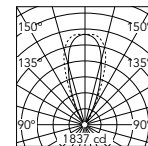

Beam Angle: 39°

h(m)	E(lx)	D(m)
1	1832	0.71
2	458	1.43
3	204	2.14
4	115	2.86
5	73	3.57

@3000K

Optic Elliptical 13° x 40°

Power Led: 17W - LED 1863 lm ≠ OUTPUT 820 lm - 2200K/CRI 80 / 17W - LED 1932 lm ≠ OUTPUT 850 lm - 2700K/CRI 80 / 17W - LED 2070 lm ≠ OUTPUT 911 lm - 3000K/CRI 80 / 17W - LED 2139 lm ≠ OUTPUT 941 lm - 4000K/CRI 80

2200K	2700K	3000K	4000K	
Non Dimmable	Non Dimmable	Non Dimmable	Non Dimmable	
● F017B1LA006	● F017B2LA006	● F017B3LA006	● F017B4LA006	810,00 €
● F017B1LA033	● F017B2LA033	● F017B3LA033	● F017B4LA033	810,00 €
1-10V	1-10V	1-10V	1-10V	
● F017B1LB006	● F017B2LB006	● F017B3LB006	● F017B4LB006	813,00 €
● F017B1LB033	● F017B2LB033	● F017B3LB033	● F017B4LB033	813,00 €
Dali	Dali	Dali	Dali	
● F017B1LD006	● F017B2LD006	● F017B3LD006	● F017B4LD006	857,00 €
● F017B1LD033	● F017B2LD033	● F017B3LD033	● F017B4LD033	857,00 €

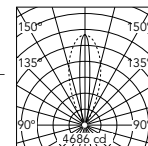

Beam Angle: 13°

h(m)	E(lx)	D(m)
1	4686	0.22
2	1172	0.44
3	521	0.67
4	293	0.89
5	187	1.11

@3000K

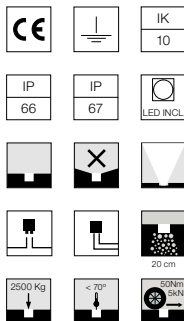
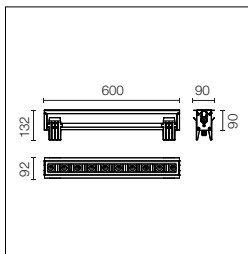

Source LED haute puissance incluse et optique en retrait équipée d'une grille à lamelles asymétrique anti-éblouissement. Alimentation 220-240 V ON-OFF et variable 1-10 V et DALI.
Le coffrage d'installation obligatoire doit être commandé séparément. Prêcâblé avec les connecteurs rapides H₂O Stop prise/fiche inclus. ACT (Anti Corrosion Treatment) sur demande.

High-power LED source included and rear lenses equipped with anti-glare asymmetrical diffuser grille. 1-10V or DALI on-off and dimmable 220-240V power supply. Compulsory installation box to be ordered separately. Pre-wired with H₂O Stop quick connectors, plug/socket included. ACT (Anti-Corrosion Treatment) upon request.

Optic Spot 16°

Power Led: 17W - LED 1863 lm ≠ OUTPUT 477 lm - 2200K/CRI 80 / 17W - LED 1932 lm ≠ OUTPUT 495 lm - 2700K/CRI 80 / 17W - LED 2070 lm ≠ OUTPUT 530 lm - 3000K/CRI 80 / 17W - LED 2139 lm ≠ OUTPUT 548 lm - 4000K/CRI 80

2200K	2700K	3000K	4000K	
Non Dimmable	Non Dimmable	Non Dimmable	Non Dimmable	
● F017B1QA006	● F017B2QA006	● F017B3QA006	● F017B4QA006	810,00 €
● F017B1QA033	● F017B2QA033	● F017B3QA033	● F017B4QA033	810,00 €
1-10V	1-10V	1-10V	1-10V	
● F017B1QB006	● F017B2QB006	● F017B3QB006	● F017B4QB006	813,00 €
● F017B1QB033	● F017B2QB033	● F017B3QB033	● F017B4QB033	813,00 €
Dali	Dali	Dali	Dali	
● F017B1QD006	● F017B2QD006	● F017B3QD006	● F017B4QD006	857,00 €
● F017B1QD033	● F017B2QD033	● F017B3QD033	● F017B4QD033	857,00 €

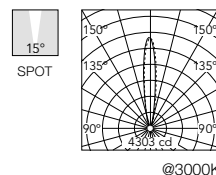

Beam Angle: 15°

h(m)	E(ft)	D(m)
1	4300	0.25
2	1075	0.51
3	478	0.76
4	269	1.02
5	172	1.27

@3000K

Optic Medium 25°

Power Led: 17W - LED 1863 lm ≠ OUTPUT 505 lm - 2200K/CRI 80 / 17W - LED 1932 lm ≠ OUTPUT 523 lm - 2700K/CRI 80 / 17W - LED 2070 lm ≠ OUTPUT 561 lm - 3000K/CRI 80 / 17W - LED 2139 lm ≠ OUTPUT 579 lm - 4000K/CRI 80

2200K	2700K	3000K	4000K	
Non Dimmable	Non Dimmable	Non Dimmable	Non Dimmable	
● F017B1RA006	● F017B2RA006	● F017B3RA006	● F017B4RA006	810,00 €
● F017B1RA033	● F017B2RA033	● F017B3RA033	● F017B4RA033	810,00 €
1-10V	1-10V	1-10V	1-10V	
● F017B1RB006	● F017B2RB006	● F017B3RB006	● F017B4RB006	813,00 €
● F017B1RB033	● F017B2RB033	● F017B3RB033	● F017B4RB033	813,00 €
Dali	Dali	Dali	Dali	
● F017B1RD006	● F017B2RD006	● F017B3RD006	● F017B4RD006	857,00 €
● F017B1RD033	● F017B2RD033	● F017B3RD033	● F017B4RD033	857,00 €

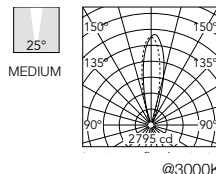

Beam Angle: 25°

h(m)	E(ft)	D(m)
1	2790	0.45
2	698	0.89
3	310	1.34
4	174	1.78
5	112	2.23

@3000K

Optic Flood 46°

Power Led: 17W - LED 1863 lm ≠ OUTPUT 404 lm - 2200K/CRI 80 / 17W - LED 1932 lm ≠ OUTPUT 419 lm - 2700K/CRI 80 / 17W - LED 2070 lm ≠ OUTPUT 449 lm - 3000K/CRI 80 / 17W - LED 2139 lm ≠ OUTPUT 464 lm - 4000K/CRI 80

2200K	2700K	3000K	4000K	
Non Dimmable	Non Dimmable	Non Dimmable	Non Dimmable	
● F017B1SA006	● F017B2SA006	● F017B3SA006	● F017B4SA006	810,00 €
● F017B1SA033	● F017B2SA033	● F017B3SA033	● F017B4SA033	810,00 €
1-10V	1-10V	1-10V	1-10V	
● F017B1SB006	● F017B2SB006	● F017B3SB006	● F017B4SB006	813,00 €
● F017B1SB033	● F017B2SB033	● F017B3SB033	● F017B4SB033	813,00 €
Dali	Dali	Dali	Dali	
● F017B1SD006	● F017B2SD006	● F017B3SD006	● F017B4SD006	857,00 €
● F017B1SD033	● F017B2SD033	● F017B3SD033	● F017B4SD033	857,00 €

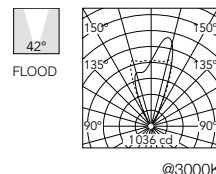

Beam Angle: 42°

h(m)	E(ft)	D(m)
1	983	0.76
2	246	1.51
3	109	2.27
4	61	3.03
5	39	3.78

@3000K

Optic Elliptical 12° x 40°

Power Led: 17W - LED 1863 lm ≠ OUTPUT 387 lm - 2200K/CRI 80 / 17W - LED 1932 lm ≠ OUTPUT 401 lm - 2700K/CRI 80 / 17W - LED 2070 lm ≠ OUTPUT 430 lm - 3000K/CRI 80 / 17W - LED 2139 lm ≠ OUTPUT 444 lm - 4000K/CRI 80

2200K	2700K	3000K	4000K	
Non Dimmable	Non Dimmable	Non Dimmable	Non Dimmable	
● F017B1TA006	● F017B2TA006	● F017B3TA006	● F017B4TA006	810,00 €
● F017B1TA033	● F017B2TA033	● F017B3TA033	● F017B4TA033	810,00 €
1-10V	1-10V	1-10V	1-10V	
● F017B1TB006	● F017B2TB006	● F017B3TB006	● F017B4TB006	813,00 €
● F017B1TB033	● F017B2TB033	● F017B3TB033	● F017B4TB033	813,00 €
Dali	Dali	Dali	Dali	
● F017B1TD006	● F017B2TD006	● F017B3TD006	● F017B4TD006	857,00 €
● F017B1TD033	● F017B2TD033	● F017B3TD033	● F017B4TD033	857,00 €

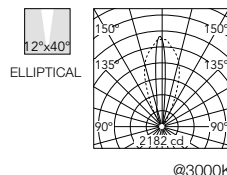

Beam Angle: 12°

h(m)	E(ft)	D(m)
1	2181	0.21
2	545	0.42
3	242	0.62
4	136	0.83
5	87	1.04

@3000K

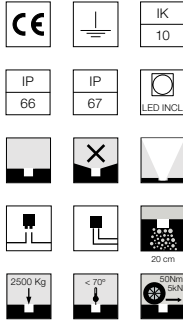
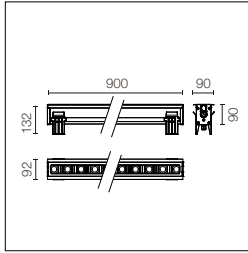

Source LED haute puissance incluse et optique en retrait.
Alimentation 220-240 V ON-OFF et variable 1-10 V et DALI.
Le coffrage d'installation obligatoire doit être commandé séparément.
Précâblé avec les connecteurs rapides H₂O Stop prise/fiche inclus.
ACT (Anti Corrosion Treatment) sur demande.

High-power LED source included and rear lenses. 1-10V or DALI on-off and dimmable 220-240V power supply.
Compulsory installation box to be ordered separately.
Pre-wired with H₂O Stop quick connectors, plug/socket included.
ACT (Anti-Corrosion Treatment) upon request.

Optic Spot 16°

Power Led: 26W - LED 2795 lm ≠ OUTPUT 2052 lm - 2200K/CRI 80 / 26W - LED 2898 lm ≠ OUTPUT 2128 lm - 2700K/CRI 80 / 26W - LED 3105 lm ≠ OUTPUT 2280 lm - 3000K/CRI 80 / 26W - LED 3209 lm ≠ OUTPUT 2356 lm - 4000K/CRI 80

2200K	2700K	3000K	4000K	
Non Dimmable	Non Dimmable	Non Dimmable	Non Dimmable	
● F017C1AA006	● F017C2AA006	● F017C3AA006	● F017C4AA006	915,00 €
● F017C1AA033	● F017C2AA033	● F017C3AA033	● F017C4AA033	915,00 €
1-10V	1-10V	1-10V	1-10V	
● F017C1AB006	● F017C2AB006	● F017C3AB006	● F017C4AB006	952,00 €
● F017C1AB033	● F017C2AB033	● F017C3AB033	● F017C4AB033	952,00 €
Dali	Dali	Dali	Dali	
● F017C1AD006	● F017C2AD006	● F017C3AD006	● F017C4AD006	969,00 €
● F017C1AD033	● F017C2AD033	● F017C3AD033	● F017C4AD033	969,00 €

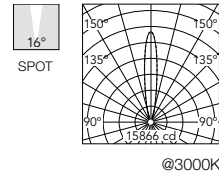

Optic Medium 25°

Power Led: 26W - LED 2795 lm ≠ OUTPUT 2209 lm - 2200K/CRI 80 / 26W - LED 2898 lm ≠ OUTPUT 2291 lm - 2700K/CRI 80 / 26W - LED 3105 lm ≠ OUTPUT 2454 lm - 3000K/CRI 80 / 26W - LED 3209 lm ≠ OUTPUT 2536 lm - 4000K/CRI 80

2200K	2700K	3000K	4000K	
Non Dimmable	Non Dimmable	Non Dimmable	Non Dimmable	
● F017C1BA006	● F017C2BA006	● F017C3BA006	● F017C4BA006	915,00 €
● F017C1BA033	● F017C2BA033	● F017C3BA033	● F017C4BA033	915,00 €
1-10V	1-10V	1-10V	1-10V	
● F017C1BB006	● F017C2BB006	● F017C3BB006	● F017C4BB006	952,00 €
● F017C1BB033	● F017C2BB033	● F017C3BB033	● F017C4BB033	952,00 €
Dali	Dali	Dali	Dali	
● F017C1BD006	● F017C2BD006	● F017C3BD006	● F017C4BD006	969,00 €
● F017C1BD033	● F017C2BD033	● F017C3BD033	● F017C4BD033	969,00 €

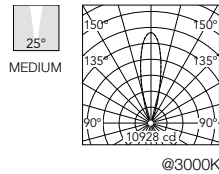

Optic Flood 46°

Power Led: 26W - LED 2795 lm ≠ OUTPUT 1924 lm - 2200K/CRI 80 / 26W - LED 2898 lm ≠ OUTPUT 1995 lm - 2700K/CRI 80 / 26W - LED 3105 lm ≠ OUTPUT 2138 lm - 3000K/CRI 80 / 26W - LED 3209 lm ≠ OUTPUT 2209 lm - 4000K/CRI 80

2200K	2700K	3000K	4000K	
Non Dimmable	Non Dimmable	Non Dimmable	Non Dimmable	
● F017C1CA006	● F017C2CA006	● F017C3CA006	● F017C4CA006	915,00 €
● F017C1CA033	● F017C2CA033	● F017C3CA033	● F017C4CA033	915,00 €
1-10V	1-10V	1-10V	1-10V	
● F017C1CB006	● F017C2CB006	● F017C3CB006	● F017C4CB006	952,00 €
● F017C1CB033	● F017C2CB033	● F017C3CB033	● F017C4CB033	952,00 €
Dali	Dali	Dali	Dali	
● F017C1CD006	● F017C2CD006	● F017C3CD006	● F017C4CD006	969,00 €
● F017C1CD033	● F017C2CD033	● F017C3CD033	● F017C4CD033	969,00 €

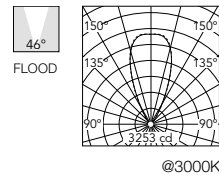

Optic Elliptical 12° x 50°

Power Led: 26W - LED 2795 lm ≠ OUTPUT 1929 lm - 2200K/CRI 80 / 26W - LED 2898 lm ≠ OUTPUT 2001 lm - 2700K/CRI 80 / 26W - LED 3105 lm ≠ OUTPUT 2144 lm - 3000K/CRI 80 / 26W - LED 3209 lm ≠ OUTPUT 2215 lm - 4000K/CRI 80

2200K	2700K	3000K	4000K	
Non Dimmable	Non Dimmable	Non Dimmable	Non Dimmable	
● F017C1DA006	● F017C2DA006	● F017C3DA006	● F017C4DA006	915,00 €
● F017C1DA033	● F017C2DA033	● F017C3DA033	● F017C4DA033	915,00 €
1-10V	1-10V	1-10V	1-10V	
● F017C1DB006	● F017C2DB006	● F017C3DB006	● F017C4DB006	952,00 €
● F017C1DB033	● F017C2DB033	● F017C3DB033	● F017C4DB033	952,00 €
Dali	Dali	Dali	Dali	
● F017C1DD006	● F017C2DD006	● F017C3DD006	● F017C4DD006	969,00 €
● F017C1DD033	● F017C2DD033	● F017C3DD033	● F017C4DD033	969,00 €

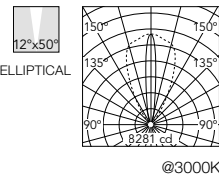

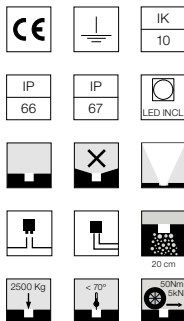
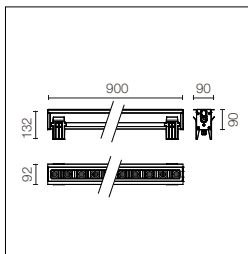

Source LED haute puissance incluse et optique en retrait équipée d'une grille à lamelles anti-éblouissement. Alimentation 220-240 V ON-OFF et variable 1-10 V et DALI. Le coffrage d'installation obligatoire doit être commandé séparément. Précâblé avec les connecteurs rapides H₂O Stop prise/fiche inclus. ACT (Anti Corrosion Treatment) sur demande.

High-power LED source included and rear lenses equipped with anti-glare diffuser grille. 1-10V or DALI on-off and dimmable 220-240V power supply. Compulsory installation box to be ordered separately. Pre-wired with H₂O Stop quick connectors, plug/socket included. ACT (Anti-Corrosion Treatment) upon request.

Optic Spot 16°

Power Led: 26W - LED 2795 lm ≠ OUTPUT 1505 lm - 2200K/CRI 80 / 26W - LED 2898 lm ≠ OUTPUT 1560 lm - 2700K/CRI 80 / 26W - LED 3105 lm ≠ OUTPUT 1672 lm - 3000K/CRI 80 / 26W - LED 3209 lm ≠ OUTPUT 1728 lm - 4000K/CRI 80

2200K	2700K	3000K	4000K	
Non Dimmable	Non Dimmable	Non Dimmable	Non Dimmable	
● F017C1HA006	● F017C2HA006	● F017C3HA006	● F017C4HA006	930,00 €
● F017C1HA033	● F017C2HA033	● F017C3HA033	● F017C4HA033	930,00 €
1-10V	1-10V	1-10V	1-10V	
● F017C1HB006	● F017C2HB006	● F017C3HB006	● F017C4HB006	967,00 €
● F017C1HB033	● F017C2HB033	● F017C3HB033	● F017C4HB033	967,00 €
Dali	Dali	Dali	Dali	
● F017C1HD006	● F017C2HD006	● F017C3HD006	● F017C4HD006	984,00 €
● F017C1HD033	● F017C2HD033	● F017C3HD033	● F017C4HD033	984,00 €

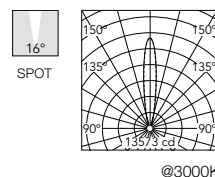

Optic Medium 25°

Power Led: 26W - LED 2795 lm ≠ OUTPUT 1594 lm - 2200K/CRI 80 / 26W - LED 2898 lm ≠ OUTPUT 1653 lm - 2700K/CRI 80 / 26W - LED 3105 lm ≠ OUTPUT 1771 lm - 3000K/CRI 80 / 26W - LED 3209 lm ≠ OUTPUT 1830 lm - 4000K/CRI 80

2200K	2700K	3000K	4000K	
Non Dimmable	Non Dimmable	Non Dimmable	Non Dimmable	
● F017C1JA006	● F017C2JA006	● F017C3JA006	● F017C4JA006	930,00 €
● F017C1JA033	● F017C2JA033	● F017C3JA033	● F017C4JA033	930,00 €
1-10V	1-10V	1-10V	1-10V	
● F017C1JB006	● F017C2JB006	● F017C3JB006	● F017C4JB006	967,00 €
● F017C1JB033	● F017C2JB033	● F017C3JB033	● F017C4JB033	967,00 €
Dali	Dali	Dali	Dali	
● F017C1JD006	● F017C2JD006	● F017C3JD006	● F017C4JD006	984,00 €
● F017C1JD033	● F017C2JD033	● F017C3JD033	● F017C4JD033	984,00 €

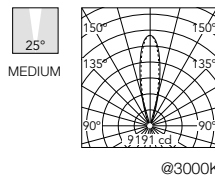

Optic Flood 39°

Power Led: 26W - LED 2795 lm ≠ OUTPUT 1233 lm - 2200K/CRI 80 / 26W - LED 2898 lm ≠ OUTPUT 1278 lm - 2700K/CRI 80 / 26W - LED 3105 lm ≠ OUTPUT 1370 lm - 3000K/CRI 80 / 26W - LED 3209 lm ≠ OUTPUT 1415 lm - 4000K/CRI 80

2200K	2700K	3000K	4000K	
Non Dimmable	Non Dimmable	Non Dimmable	Non Dimmable	
● F017C1KA006	● F017C2KA006	● F017C3KA006	● F017C4KA006	930,00 €
● F017C1KA033	● F017C2KA033	● F017C3KA033	● F017C4KA033	930,00 €
1-10V	1-10V	1-10V	1-10V	
● F017C1KB006	● F017C2KB006	● F017C3KB006	● F017C4KB006	967,00 €
● F017C1KB033	● F017C2KB033	● F017C3KB033	● F017C4KB033	967,00 €
Dali	Dali	Dali	Dali	
● F017C1KD006	● F017C2KD006	● F017C3KD006	● F017C4KD006	984,00 €
● F017C1KD033	● F017C2KD033	● F017C3KD033	● F017C4KD033	984,00 €

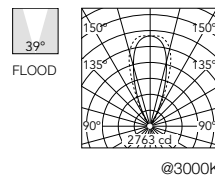

Optic Elliptical 13° x 40°

Power Led: 26W - LED 2795 lm ≠ OUTPUT 1229 lm - 2200K/CRI 80 / 26W - LED 2898 lm ≠ OUTPUT 1275 lm - 2700K/CRI 80 / 26W - LED 3105 lm ≠ OUTPUT 1366 lm - 3000K/CRI 80 / 26W - LED 3209 lm ≠ OUTPUT 1411 lm - 4000K/CRI 80

2200K	2700K	3000K	4000K	
Non Dimmable	Non Dimmable	Non Dimmable	Non Dimmable	
● F017C1LA006	● F017C2LA006	● F017C3LA006	● F017C4LA006	930,00 €
● F017C1LA033	● F017C2LA033	● F017C3LA033	● F017C4LA033	930,00 €
1-10V	1-10V	1-10V	1-10V	
● F017C1LB006	● F017C2LB006	● F017C3LB006	● F017C4LB006	967,00 €
● F017C1LB033	● F017C2LB033	● F017C3LB033	● F017C4LB033	967,00 €
Dali	Dali	Dali	Dali	
● F017C1LD006	● F017C2LD006	● F017C3LD006	● F017C4LD006	984,00 €
● F017C1LD033	● F017C2LD033	● F017C3LD033	● F017C4LD033	984,00 €

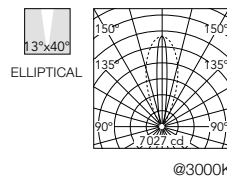

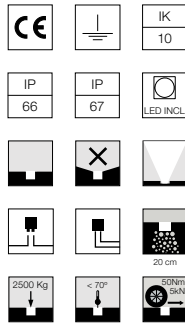
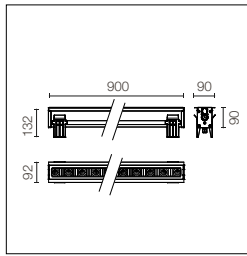

Source LED haute puissance incluse et optique en retrait équipée d'une grille à lamelles asymétrique anti-éblouissement. Alimentation 220-240 V ON-OFF et variable 1-10 V et DALI.
Le coffrage d'installation obligatoire doit être commandé séparément. Précâblé avec les connecteurs rapides H₂O Stop prise/fiche inclus. ACT (Anti Corrosion Treatment) sur demande.

High-power LED source included and rear lenses equipped with anti-glare asymmetrical diffuser grille. 1-10V or DALI on-off and dimmable 220-240V power supply. Compulsory installation box to be ordered separately. Pre-wired with H₂O Stop quick connectors, plug/socket included. ACT (Anti-Corrosion Treatment) upon request.

Optic Spot 15°

Power Led: 26W - LED 2795 lm ≠ OUTPUT 715 lm - 2200K/CRI 80 / 26W - LED 2898 lm ≠ OUTPUT 742 lm - 2700K/CRI 80 / 26W - LED 3105 lm ≠ OUTPUT 795 lm - 3000K/CRI 80 / 26W - LED 3209 lm ≠ OUTPUT 821 lm - 4000K/CRI 80

2200K	2700K	3000K	4000K	
Non Dimmable	Non Dimmable	Non Dimmable	Non Dimmable	
● F017C1QA006	● F017C2QA006	● F017C3QA006	● F017C4QA006	930,00 €
● F017C1QA033	● F017C2QA033	● F017C3QA033	● F017C4QA033	930,00 €
1-10V	1-10V	1-10V	1-10V	
● F017C1QB006	● F017C2QB006	● F017C3QB006	● F017C4QB006	967,00 €
● F017C1QB033	● F017C2QB033	● F017C3QB033	● F017C4QB033	967,00 €
Dali	Dali	Dali	Dali	
● F017C1QD006	● F017C2QD006	● F017C3QD006	● F017C4QD006	984,00 €
● F017C1QD033	● F017C2QD033	● F017C3QD033	● F017C4QD033	984,00 €

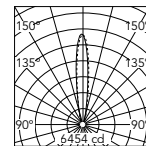

Beam Angle: 15°

h(m)	E(lx)	D(m)
1	6451	0.25
2	1613	0.51
3	717	0.76
4	403	1.02
5	258	1.27

@3000K

Optic Medium 25°

Power Led: 26W - LED 2795 lm ≠ OUTPUT 757 lm - 2200K/CRI 80 / 26W - LED 2898 lm ≠ OUTPUT 785 lm - 2700K/CRI 80 / 26W - LED 3105 lm ≠ OUTPUT 841 lm - 3000K/CRI 80 / 26W - LED 3209 lm ≠ OUTPUT 869 lm - 4000K/CRI 80

2200K	2700K	3000K	4000K	
Non Dimmable	Non Dimmable	Non Dimmable	Non Dimmable	
● F017C1RA006	● F017C2RA006	● F017C3RA006	● F017C4RA006	930,00 €
● F017C1RA033	● F017C2RA033	● F017C3RA033	● F017C4RA033	930,00 €
1-10V	1-10V	1-10V	1-10V	
● F017C1RB006	● F017C2RB006	● F017C3RB006	● F017C4RB006	967,00 €
● F017C1RB033	● F017C2RB033	● F017C3RB033	● F017C4RB033	967,00 €
Dali	Dali	Dali	Dali	
● F017C1RD006	● F017C2RD006	● F017C3RD006	● F017C4RD006	984,00 €
● F017C1RD033	● F017C2RD033	● F017C3RD033	● F017C4RD033	984,00 €

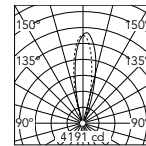

Beam Angle: 25°

h(m)	E(lx)	D(m)
1	4183	0.45
2	1046	0.89
3	465	1.34
4	261	1.78
5	167	2.23

@3000K

Optic Flood 42°

Power Led: 26W - LED 2795 lm ≠ OUTPUT 606 lm - 2200K/CRI 80 / 26W - LED 2898 lm ≠ OUTPUT 628 lm - 2700K/CRI 80 / 26W - LED 3105 lm ≠ OUTPUT 673 lm - 3000K/CRI 80 / 26W - LED 3209 lm ≠ OUTPUT 696 lm - 4000K/CRI 80

2200K	2700K	3000K	4000K	
Non Dimmable	Non Dimmable	Non Dimmable	Non Dimmable	
● F017C1SA006	● F017C2SA006	● F017C3SA006	● F017C4SA006	930,00 €
● F017C1SA033	● F017C2SA033	● F017C3SA033	● F017C4SA033	930,00 €
1-10V	1-10V	1-10V	1-10V	
● F017C1SB006	● F017C2SB006	● F017C3SB006	● F017C4SB006	967,00 €
● F017C1SB033	● F017C2SB033	● F017C3SB033	● F017C4SB033	967,00 €
Dali	Dali	Dali	Dali	
● F017C1SD006	● F017C2SD006	● F017C3SD006	● F017C4SD006	984,00 €
● F017C1SD033	● F017C2SD033	● F017C3SD033	● F017C4SD033	984,00 €

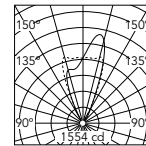

Beam Angle: 42°

h(m)	E(lx)	D(m)
1	1474	0.76
2	368	1.51
3	164	2.27
4	92	3.03
5	59	3.78

@3000K

Optic Elliptical 12° x 40°

Power Led: 26W - LED 2795 lm ≠ OUTPUT 580 lm - 2200K/CRI 80 / 26W - LED 2898 lm ≠ OUTPUT 602 lm - 2700K/CRI 80 / 26W - LED 3105 lm ≠ OUTPUT 645 lm - 3000K/CRI 80 / 26W - LED 3209 lm ≠ OUTPUT 666 lm - 4000K/CRI 80

2200K	2700K	3000K	4000K	
Non Dimmable	Non Dimmable	Non Dimmable	Non Dimmable	
● F017C1TA006	● F017C2TA006	● F017C3TA006	● F017C4TA006	930,00 €
● F017C1TA033	● F017C2TA033	● F017C3TA033	● F017C4TA033	930,00 €
1-10V	1-10V	1-10V	1-10V	
● F017C1TB006	● F017C2TB006	● F017C3TB006	● F017C4TB006	967,00 €
● F017C1TB033	● F017C2TB033	● F017C3TB033	● F017C4TB033	967,00 €
Dali	Dali	Dali	Dali	
● F017C1TD006	● F017C2TD006	● F017C3TD006	● F017C4TD006	984,00 €
● F017C1TD033	● F017C2TD033	● F017C3TD033	● F017C4TD033	984,00 €

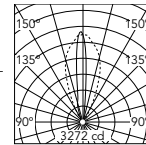

Beam Angle: 12°

h(m)	E(lx)	D(m)
1	3271	0.21
2	818	0.42
3	363	0.62
4	204	0.83
5	131	1.04

@3000K

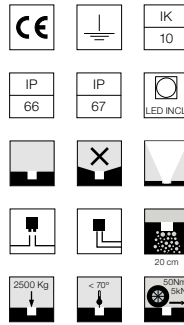
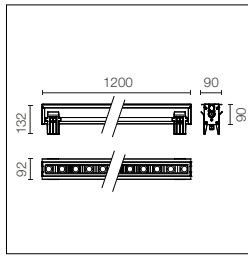

Source LED haute puissance incluse et optique en retrait.
Alimentation 220-240 V ON-OFF et variable 1-10 V et DALI.
Le coffrage d'installation obligatoire doit être commandé séparément.
Précâblé avec les connecteurs rapides H₂O Stop prise/fiche inclus.
ACT (Anti Corrosion Treatment) sur demande.

High-power LED source included and rear lenses. 1-10V or DALI on-off and dimmable 220-240V power supply.
Compulsory installation box to be ordered separately.
Pre-wired with H₂O Stop quick connectors, plug/socket included.
ACT (Anti-Corrosion Treatment) upon request.

Optic Spot 16°

Power Led: 33,5W - LED 3726 lm ≠ OUTPUT 2736 lm - 2200K/CRI 80 / 33,5W - LED 3864 lm ≠ OUTPUT 2837 lm - 2700K/CRI 80 / 33,5W - LED 4140 lm ≠ OUTPUT 3040 lm - 3000K/CRI 80 / 33,5W - LED 4278 lm ≠ OUTPUT 3141 lm - 4000K/CRI 80

2200K	2700K	3000K	4000K	
Non Dimmable	Non Dimmable	Non Dimmable	Non Dimmable	
● F017D1AA006	● F017D2AA006	● F017D3AA006	● F017D4AA006	1.038,00 €
● F017D1AA033	● F017D2AA033	● F017D3AA033	● F017D4AA033	1.038,00 €
1-10V	1-10V	1-10V	1-10V	
● F017D1AB006	● F017D2AB006	● F017D3AB006	● F017D4AB006	1.081,00 €
● F017D1AB033	● F017D2AB033	● F017D3AB033	● F017D4AB033	1.081,00 €
Dali	Dali	Dali	Dali	
● F017D1AD006	● F017D2AD006	● F017D3AD006	● F017D4AD006	1.096,00 €
● F017D1AD033	● F017D2AD033	● F017D3AD033	● F017D4AD033	1.096,00 €

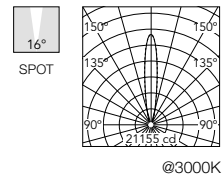

Beam Angle: 16°

h(m)	E(lx)	D(m)
1	21155	0.27
2	5289	0.55
3	2351	0.82
4	1322	1.09
5	846	1.37

Optic Medium 25°

Power Led: 33,5W - LED 3726 lm ≠ OUTPUT 2945 lm - 2200K/CRI 80 / 33,5W - LED 3864 lm ≠ OUTPUT 3054 lm - 2700K/CRI 80 / 33,5W - LED 4140 lm ≠ OUTPUT 3272 lm - 3000K/CRI 80 / 33,5W - LED 4278 lm ≠ OUTPUT 3381 lm - 4000K/CRI 80

2200K	2700K	3000K	4000K	
Non Dimmable	Non Dimmable	Non Dimmable	Non Dimmable	
● F017D1BA006	● F017D2BA006	● F017D3BA006	● F017D4BA006	1.038,00 €
● F017D1BA033	● F017D2BA033	● F017D3BA033	● F017D4BA033	1.038,00 €
1-10V	1-10V	1-10V	1-10V	
● F017D1BB006	● F017D2BB006	● F017D3BB006	● F017D4BB006	1.081,00 €
● F017D1BB033	● F017D2BB033	● F017D3BB033	● F017D4BB033	1.081,00 €
Dali	Dali	Dali	Dali	
● F017D1BD006	● F017D2BD006	● F017D3BD006	● F017D4BD006	1.096,00 €
● F017D1BD033	● F017D2BD033	● F017D3BD033	● F017D4BD033	1.096,00 €

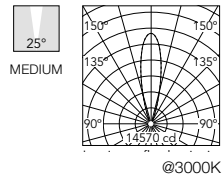

Beam Angle: 25°

h(m)	E(lx)	D(m)
1	14570	0.44
2	3643	0.88
3	1619	1.32
4	911	1.76
5	583	2.20

Optic Flood 46°

Power Led: 33,5W - LED 3726 lm ≠ OUTPUT 2565 lm - 2200K/CRI 80 / 33,5W - LED 3864 lm ≠ OUTPUT 2660 lm - 2700K/CRI 80 / 33,5W - LED 4140 lm ≠ OUTPUT 2850 lm - 3000K/CRI 80 / 33,5W - LED 4278 lm ≠ OUTPUT 2945 lm - 4000K/CRI 80

2200K	2700K	3000K	4000K	
Non Dimmable	Non Dimmable	Non Dimmable	Non Dimmable	
● F017D1CA006	● F017D2CA006	● F017D3CA006	● F017D4CA006	1.038,00 €
● F017D1CA033	● F017D2CA033	● F017D3CA033	● F017D4CA033	1.038,00 €
1-10V	1-10V	1-10V	1-10V	
● F017D1CB006	● F017D2CB006	● F017D3CB006	● F017D4CB006	1.081,00 €
● F017D1CB033	● F017D2CB033	● F017D3CB033	● F017D4CB033	1.081,00 €
Dali	Dali	Dali	Dali	
● F017D1CD006	● F017D2CD006	● F017D3CD006	● F017D4CD006	1.096,00 €
● F017D1CD033	● F017D2CD033	● F017D3CD033	● F017D4CD033	1.096,00 €

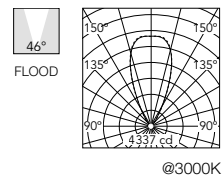

Beam Angle: 46°

h(m)	E(lx)	D(m)
1	4316	0.85
2	1079	1.71
3	480	2.56
4	270	3.42
5	173	4.27

Optic Elliptical 12° x 50°

Power Led: 33,5W - LED 3726 lm ≠ OUTPUT 2572 lm - 2200K/CRI 80 / 33,5W - LED 3864 lm ≠ OUTPUT 2668 lm - 2700K/CRI 80 / 33,5W - LED 4140 lm ≠ OUTPUT 2858 lm - 3000K/CRI 80 / 33,5W - LED 4278 lm ≠ OUTPUT 2953 lm - 4000K/CRI 80

2200K	2700K	3000K	4000K	
Non Dimmable	Non Dimmable	Non Dimmable	Non Dimmable	
● F017D1DA006	● F017D2DA006	● F017D3DA006	● F017D4DA006	1.038,00 €
● F017D1DA033	● F017D2DA033	● F017D3DA033	● F017D4DA033	1.038,00 €
1-10V	1-10V	1-10V	1-10V	
● F017D1DB006	● F017D2DB006	● F017D3DB006	● F017D4DB006	1.081,00 €
● F017D1DB033	● F017D2DB033	● F017D3DB033	● F017D4DB033	1.081,00 €
Dali	Dali	Dali	Dali	
● F017D1DD006	● F017D2DD006	● F017D3DD006	● F017D4DD006	1.096,00 €
● F017D1DD033	● F017D2DD033	● F017D3DD033	● F017D4DD033	1.096,00 €

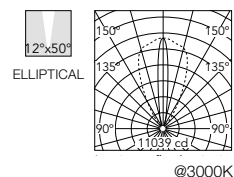

Beam Angle: 12°

h(m)	E(lx)	D(m)
1	11037	0.22
2	2759	0.44
3	1226	0.66
4	690	0.87
5	441	1.09

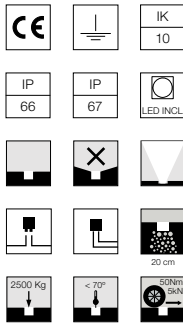
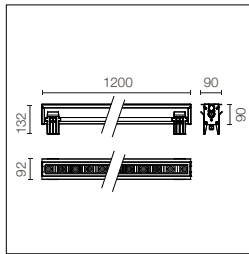

Source LED haute puissance incluse et optique en retrait équipée d'une grille à lamelles anti-éblouissement. Alimentation 220-240 V ON-OFF et variable 1-10 V et DALI. Le coffrage d'installation obligatoire doit être commandé séparément. Précâblé avec les connecteurs rapides H₂O Stop prise/fiche inclus. ACT (Anti Corrosion Treatment) sur demande.

High-power LED source included and rear lenses equipped with anti-glare diffuser grille. 1-10V or DALI on-off and dimmable 220-240V power supply. Compulsory installation box to be ordered separately. Pre-wired with H₂O Stop quick connectors, plug/socket included. ACT (Anti-Corrosion Treatment) upon request.

Optic Spot 16°

Power Led: 33,5W - LED 3726 lm ≠ OUTPUT 2006 lm - 2200K/CRI 80 / 33,5W - LED 3864 lm ≠ OUTPUT 2080 lm - 2700K/CRI 80 / 33,5W - LED 4140 lm ≠ OUTPUT 2229 lm - 3000K/CRI 80 / 33,5W - LED 4278 lm ≠ OUTPUT 2303 lm - 4000K/CRI 80

2200K	2700K	3000K	4000K	
Non Dimmable	Non Dimmable	Non Dimmable	Non Dimmable	
● F017D1HA006	● F017D2HA006	● F017D3HA006	● F017D4HA006	1.058,00 €
● F017D1HA033	● F017D2HA033	● F017D3HA033	● F017D4HA033	1.058,00 €
1-10V	1-10V	1-10V	1-10V	
● F017D1HB006	● F017D2HB006	● F017D3HB006	● F017D4HB006	1.101,00 €
● F017D1HB033	● F017D2HB033	● F017D3HB033	● F017D4HB033	1.101,00 €
Dali	Dali	Dali	Dali	
● F017D1HD006	● F017D2HD006	● F017D3HD006	● F017D4HD006	1.116,00 €
● F017D1HD033	● F017D2HD033	● F017D3HD033	● F017D4HD033	1.116,00 €

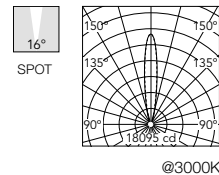

Beam Angle: 16°

h(m)	E(lx)	D(m)
1	18095	0.28
2	4524	0.56
3	2011	0.83
4	1131	1.11
5	724	1.39

Optic Medium 25°

Power Led: 33,5W - LED 3726 lm ≠ OUTPUT 2125 lm - 2200K/CRI 80 / 33,5W - LED 3864 lm ≠ OUTPUT 2203 lm - 2700K/CRI 80 / 33,5W - LED 4140 lm ≠ OUTPUT 2361 lm - 3000K/CRI 80 / 33,5W - LED 4278 lm ≠ OUTPUT 2439 lm - 4000K/CRI 80

2200K	2700K	3000K	4000K	
Non Dimmable	Non Dimmable	Non Dimmable	Non Dimmable	
● F017D1JA006	● F017D2JA006	● F017D3JA006	● F017D4JA006	1.058,00 €
● F017D1JA033	● F017D2JA033	● F017D3JA033	● F017D4JA033	1.058,00 €
1-10V	1-10V	1-10V	1-10V	
● F017D1JB006	● F017D2JB006	● F017D3JB006	● F017D4JB006	1.101,00 €
● F017D1JB033	● F017D2JB033	● F017D3JB033	● F017D4JB033	1.101,00 €
Dali	Dali	Dali	Dali	
● F017D1JD006	● F017D2JD006	● F017D3JD006	● F017D4JD006	1.116,00 €
● F017D1JD033	● F017D2JD033	● F017D3JD033	● F017D4JD033	1.116,00 €

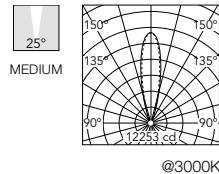

Beam Angle: 25°

h(m)	E(lx)	D(m)
1	12253	0.44
2	3063	0.87
3	1361	1.31
4	766	1.74
5	490	2.18

Optic Flood 39°

Power Led: 33,5W - LED 3726 lm ≠ OUTPUT 1643 lm - 2200K/CRI 80 / 33,5W - LED 3864 lm ≠ OUTPUT 1704 lm - 2700K/CRI 80 / 33,5W - LED 4140 lm ≠ OUTPUT 1826 lm - 3000K/CRI 80 / 33,5W - LED 4278 lm ≠ OUTPUT 1887 lm - 4000K/CRI 80

2200K	2700K	3000K	4000K	
Non Dimmable	Non Dimmable	Non Dimmable	Non Dimmable	
● F017D1KA006	● F017D2KA006	● F017D3KA006	● F017D4KA006	1.058,00 €
● F017D1KA033	● F017D2KA033	● F017D3KA033	● F017D4KA033	1.058,00 €
1-10V	1-10V	1-10V	1-10V	
● F017D1KB006	● F017D2KB006	● F017D3KB006	● F017D4KB006	1.101,00 €
● F017D1KB033	● F017D2KB033	● F017D3KB033	● F017D4KB033	1.101,00 €
Dali	Dali	Dali	Dali	
● F017D1KD006	● F017D2KD006	● F017D3KD006	● F017D4KD006	1.116,00 €
● F017D1KD033	● F017D2KD033	● F017D3KD033	● F017D4KD033	1.116,00 €

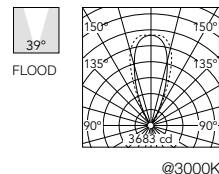

Beam Angle: 39°

h(m)	E(lx)	D(m)
1	3672	0.71
2	918	1.43
3	408	2.14
4	230	2.86
5	147	3.57

Optic Elliptical 13° x 40°

Power Led: 33,5W - LED 3726 lm ≠ OUTPUT 1639 lm - 2200K/CRI 80 / 33,5W - LED 3864 lm ≠ OUTPUT 1700 lm - 2700K/CRI 80 / 33,5W - LED 4140 lm ≠ OUTPUT 1821 lm - 3000K/CRI 80 / 33,5W - LED 4278 lm ≠ OUTPUT 1882 lm - 4000K/CRI 80

2200K	2700K	3000K	4000K	
Non Dimmable	Non Dimmable	Non Dimmable	Non Dimmable	
● F017D1LA006	● F017D2LA006	● F017D3LA006	● F017D4LA006	1.058,00 €
● F017D1LA033	● F017D2LA033	● F017D3LA033	● F017D4LA033	1.058,00 €
1-10V	1-10V	1-10V	1-10V	
● F017D1LB006	● F017D2LB006	● F017D3LB006	● F017D4LB006	1.101,00 €
● F017D1LB033	● F017D2LB033	● F017D3LB033	● F017D4LB033	1.101,00 €
Dali	Dali	Dali	Dali	
● F017D1LD006	● F017D2LD006	● F017D3LD006	● F017D4LD006	1.116,00 €
● F017D1LD033	● F017D2LD033	● F017D3LD033	● F017D4LD033	1.116,00 €

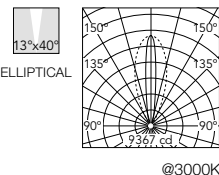

Beam Angle: 13°

h(m)	E(lx)	D(m)
1	9367	0.22
2	2342	0.44
3	1041	0.67
4	585	0.89
5	375	1.11

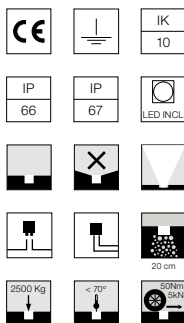
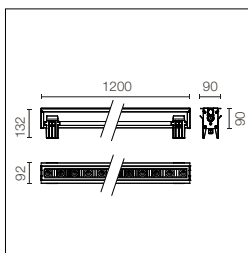

Source LED haute puissance incluse et optique en retrait équipée d'une grille à lamelles asymétrique anti-éblouissement. Alimentation 220-240 V ON-OFF et variable 1-10 V et DALI.
Le coffrage d'installation obligatoire doit être commandé séparément. Précâblé avec les connecteurs rapides H₂O Stop prise/fiche inclus. ACT (Anti Corrosion Treatment) sur demande.

High-power LED source included and rear lenses equipped with anti-glare asymmetrical diffuser grille. 1-10V or DALI on-off and dimmable 220-240V power supply. Compulsory installation box to be ordered separately. Pre-wired with H₂O Stop quick connectors, plug/socket included. ACT (Anti-Corrosion Treatment) upon request.

Optic Spot 15°

Power Led: 33,5W - LED 3726 lm ≠ OUTPUT 954 lm - 2200K/CRI 80 / 33,5W - LED 3864 lm ≠ OUTPUT 989 lm - 2700K/CRI 80 / 33,5W - LED 4140 lm ≠ OUTPUT 1059 lm - 3000K/CRI 80 / 33,5W - LED 4278 lm ≠ OUTPUT 1095 lm - 4000K/CRI 80

2200K	2700K	3000K	4000K	
Non Dimmable	Non Dimmable	Non Dimmable	Non Dimmable	
● F017D1QA006	● F017D2QA006	● F017D3QA006	● F017D4QA006	1.058,00 €
● F017D1QA033	● F017D2QA033	● F017D3QA033	● F017D4QA033	1.058,00 €
1-10V	1-10V	1-10V	1-10V	
● F017D1QB006	● F017D2QB006	● F017D3QB006	● F017D4QB006	1.101,00 €
● F017D1QB033	● F017D2QB033	● F017D3QB033	● F017D4QB033	1.101,00 €
Dali	Dali	Dali	Dali	
● F017D1QD006	● F017D2QD006	● F017D3QD006	● F017D4QD006	1.116,00 €
● F017D1QD033	● F017D2QD033	● F017D3QD033	● F017D4QD033	1.116,00 €

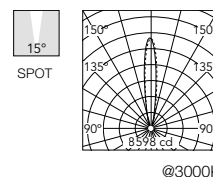

Beam Angle: 15°

h(m)	E(ft)	D(m)
1	8593	0.25
2	2148	0.51
3	955	0.76
4	537	1.02
5	344	1.27

@3000K

Optic Medium 25°

Power Led: 33,5W - LED 3726 lm ≠ OUTPUT 1009 lm - 2200K/CRI 80 / 33,5W - LED 3864 lm ≠ OUTPUT 1046 lm - 2700K/CRI 80 / 33,5W - LED 4140 lm ≠ OUTPUT 1121 lm - 3000K/CRI 80 / 33,5W - LED 4278 lm ≠ OUTPUT 1158 lm - 4000K/CRI 80

2200K	2700K	3000K	4000K	
Non Dimmable	Non Dimmable	Non Dimmable	Non Dimmable	
● F017D1RA006	● F017D2RA006	● F017D3RA006	● F017D4RA006	1.058,00 €
● F017D1RA033	● F017D2RA033	● F017D3RA033	● F017D4RA033	1.058,00 €
1-10V	1-10V	1-10V	1-10V	
● F017D1RB006	● F017D2RB006	● F017D3RB006	● F017D4RB006	1.101,00 €
● F017D1RB033	● F017D2RB033	● F017D3RB033	● F017D4RB033	1.101,00 €
Dali	Dali	Dali	Dali	
● F017D1RD006	● F017D2RD006	● F017D3RD006	● F017D4RD006	1.116,00 €
● F017D1RD033	● F017D2RD033	● F017D3RD033	● F017D4RD033	1.116,00 €

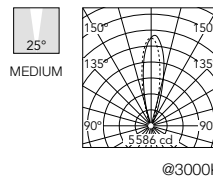

Beam Angle: 25°

h(m)	E(ft)	D(m)
1	5576	0.45
2	1394	0.89
3	620	1.34
4	349	1.78
5	223	2.23

@3000K

Optic Flood 42°

Power Led: 33,5W - LED 3726 lm ≠ OUTPUT 808 lm - 2200K/CRI 80 / 33,5W - LED 3864 lm ≠ OUTPUT 838 lm - 2700K/CRI 80 / 33,5W - LED 4140 lm ≠ OUTPUT 898 lm - 3000K/CRI 80 / 33,5W - LED 4278 lm ≠ OUTPUT 928 lm - 4000K/CRI 80

2200K	2700K	3000K	4000K	
Non Dimmable	Non Dimmable	Non Dimmable	Non Dimmable	
● F017D1SA006	● F017D2SA006	● F017D3SA006	● F017D4SA006	1.058,00 €
● F017D1SA033	● F017D2SA033	● F017D3SA033	● F017D4SA033	1.058,00 €
1-10V	1-10V	1-10V	1-10V	
● F017D1SB006	● F017D2SB006	● F017D3SB006	● F017D4SB006	1.101,00 €
● F017D1SB033	● F017D2SB033	● F017D3SB033	● F017D4SB033	1.101,00 €
Dali	Dali	Dali	Dali	
● F017D1SD006	● F017D2SD006	● F017D3SD006	● F017D4SD006	1.116,00 €
● F017D1SD033	● F017D2SD033	● F017D3SD033	● F017D4SD033	1.116,00 €

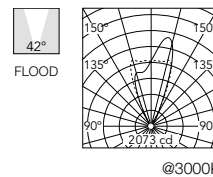

Beam Angle: 42°

h(m)	E(ft)	D(m)
1	1967	0.76
2	492	1.51
3	219	2.27
4	123	3.03
5	79	3.78

@3000K

Optic Elliptical 12° x 40°

Power Led: 33,5W - LED 3726 lm ≠ OUTPUT 773 lm - 2200K/CRI 80 / 33,5W - LED 3864 lm ≠ OUTPUT 802 lm - 2700K/CRI 80 / 33,5W - LED 4140 lm ≠ OUTPUT 859 lm - 3000K/CRI 80 / 33,5W - LED 4278 lm ≠ OUTPUT 888 lm - 4000K/CRI 80

2200K	2700K	3000K	4000K	
Non Dimmable	Non Dimmable	Non Dimmable	Non Dimmable	
● F017D1TA006	● F017D2TA006	● F017D3TA006	● F017D4TA006	1.058,00 €
● F017D1TA033	● F017D2TA033	● F017D3TA033	● F017D4TA033	1.058,00 €
1-10V	1-10V	1-10V	1-10V	
● F017D1TB006	● F017D2TB006	● F017D3TB006	● F017D4TB006	1.101,00 €
● F017D1TB033	● F017D2TB033	● F017D3TB033	● F017D4TB033	1.101,00 €
Dali	Dali	Dali	Dali	
● F017D1TD006	● F017D2TD006	● F017D3TD006	● F017D4TD006	1.116,00 €
● F017D1TD033	● F017D2TD033	● F017D3TD033	● F017D4TD033	1.116,00 €

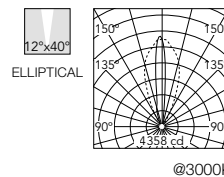

Beam Angle: 12°

h(m)	E(ft)	D(m)
1	4356	0.21
2	1089	0.42
3	484	0.62
4	272	0.83
5	174	1.04

@3000K

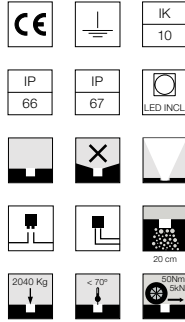
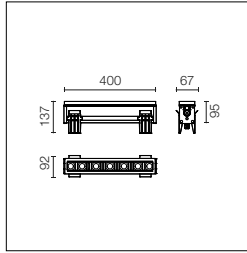

Source LED haute puissance incluse et optique en retrait.
Alimentation 220-240 V ON-OFF et variable 1-10 V et DALI.
Le coffrage d'installation obligatoire doit être commandé séparément.
Précâblé avec les connecteurs rapides H₂O Stop prise/fiche inclus.
ACT (Anti Corrosion Treatment) sur demande.

High-power LED source included and rear lenses. 1-10V or DALI on-off and dimmable 220-240V power supply.
Compulsory installation box to be ordered separately.
Pre-wired with H₂O Stop quick connectors, plug/socket included.
ACT (Anti-Corrosion Treatment) upon request.

Optic Spot 16°

Power Led: 12,5W - LED 1304 lm ≠ OUTPUT 958 lm - 2200K/CRI 80 / 12,5W - LED 1352 lm ≠ OUTPUT 993 lm - 2700K/CRI 80 / 12,5W - LED 1449 lm ≠ OUTPUT 1064 lm - 3000K/CRI 80 / 12,5W - LED 1497 lm ≠ OUTPUT 1100 lm - 4000K/CRI 80

2200K

Non Dimmable

- F017J1AA006
- F017J1AA033
- 1-10V
- F017J1AB006
- F017J1AB033
- Dali
- F017J1AD006
- F017J1AD033

2700K

Non Dimmable

- F017J2AA006
- F017J2AA033
- 1-10V
- F017J2AB006
- F017J2AB033
- Dali
- F017J2AD006
- F017J2AD033

3000K

Non Dimmable

- F017J3AA006
- F017J3AA033
- 1-10V
- F017J3AB006
- F017J3AB033
- Dali
- F017J3AD006
- F017J3AD033

4000K

Non Dimmable

- F017J4AA006 648,00 €
- F017J4AA033 648,00 €
- 1-10V
- F017J4AB006 673,00 €
- F017J4AB033 673,00 €
- Dali
- F017J4AD006 684,00 €
- F017J4AD033 684,00 €

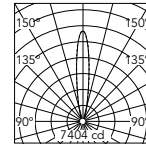

Beam Angle: 16°

h(m)	E(lx)	D(m)
1	7404	0.27
2	1851	0.55
3	823	0.82
4	463	1.09
5	296	1.37

@3000K

Optic Medium 25°

Power Led: 12,5W - LED 1304 lm ≠ OUTPUT 1031 lm - 2200K/CRI 80 / 12,5W - LED 1352 lm ≠ OUTPUT 1069 lm - 2700K/CRI 80 / 12,5W - LED 1449 lm ≠ OUTPUT 1146 lm - 3000K/CRI 80 / 12,5W - LED 1497 lm ≠ OUTPUT 1184 lm - 4000K/CRI 80

2200K

Non Dimmable

- F017J1BA006
- F017J1BA033
- 1-10V
- F017J1BB006
- F017J1BB033
- Dali
- F017J1BD006
- F017J1BD033

2700K

Non Dimmable

- F017J2BA006
- F017J2BA033
- 1-10V
- F017J2BB006
- F017J2BB033
- Dali
- F017J2BD006
- F017J2BD033

3000K

Non Dimmable

- F017J3BA006
- F017J3BA033
- 1-10V
- F017J3BB006
- F017J3BB033
- Dali
- F017J3BD006
- F017J3BD033

4000K

Non Dimmable

- F017J4BA006 648,00 €
- F017J4BA033 648,00 €
- 1-10V
- F017J4BB006 673,00 €
- F017J4BB033 673,00 €
- Dali
- F017J4BD006 684,00 €
- F017J4BD033 684,00 €

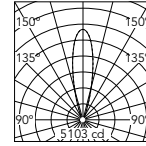

Beam Angle: 25°

h(m)	E(lx)	D(m)
1	5103	0.44
2	1276	0.88
3	567	1.32
4	319	1.76
5	204	2.20

@3000K

Optic Flood 46°

Power Led: 12,5W - LED 1304 lm ≠ OUTPUT 898 lm - 2200K/CRI 80 / 12,5W - LED 1352 lm ≠ OUTPUT 931 lm - 2700K/CRI 80 / 12,5W - LED 1449 lm ≠ OUTPUT 998 lm - 3000K/CRI 80 / 12,5W - LED 1497 lm ≠ OUTPUT 1031 lm - 4000K/CRI 80

2200K

Non Dimmable

- F017J1CA006
- F017J1CA033
- 1-10V
- F017J1CB006
- F017J1CB033
- Dali
- F017J1CD006
- F017J1CD033

2700K

Non Dimmable

- F017J2CA006
- F017J2CA033
- 1-10V
- F017J2CB006
- F017J2CB033
- Dali
- F017J2CD006
- F017J2CD033

3000K

Non Dimmable

- F017J3CA006
- F017J3CA033
- 1-10V
- F017J3CB006
- F017J3CB033
- Dali
- F017J3CD006
- F017J3CD033

4000K

Non Dimmable

- F017J4CA006 648,00 €
- F017J4CA033 648,00 €
- 1-10V
- F017J4CB006 673,00 €
- F017J4CB033 673,00 €
- Dali
- F017J4CD006 684,00 €
- F017J4CD033 684,00 €

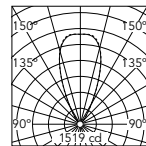

Beam Angle: 46°

h(m)	E(lx)	D(m)
1	1511	0.85
2	378	1.71
3	168	2.56
4	94	3.42
5	60	4.27

@3000K

Optic Elliptical 12° x 50°

Power Led: 12,5W - LED 1304 lm ≠ OUTPUT 901 lm - 2200K/CRI 80 / 12,5W - LED 1352 lm ≠ OUTPUT 934 lm - 2700K/CRI 80 / 12,5W - LED 1449 lm ≠ OUTPUT 1001 lm - 3000K/CRI 80 / 12,5W - LED 1497 lm ≠ OUTPUT 1034 lm - 4000K/CRI 80

2200K

Non Dimmable

- F017J1DA006
- F017J1DA033
- 1-10V
- F017J1DB006
- F017J1DB033
- Dali
- F017J1DD006
- F017J1DD033

2700K

Non Dimmable

- F017J2DA006
- F017J2DA033
- 1-10V
- F017J2DB006
- F017J2DB033
- Dali
- F017J2DD006
- F017J2DD033

3000K

Non Dimmable

- F017J3DA006
- F017J3DA033
- 1-10V
- F017J3DB006
- F017J3DB033
- Dali
- F017J3DD006
- F017J3DD033

4000K

Non Dimmable

- F017J4DA006 648,00 €
- F017J4DA033 648,00 €
- 1-10V
- F017J4DB006 673,00 €
- F017J4DB033 673,00 €
- Dali
- F017J4DD006 684,00 €
- F017J4DD033 684,00 €

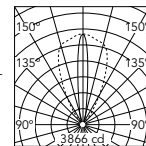

Beam Angle: 12°

h(m)	E(lx)	D(m)
1	3866	0.22
2	966	0.44
3	430	0.66
4	242	0.87
5	155	1.09

@3000K

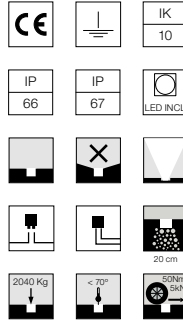
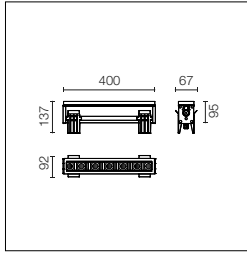

Source LED haute puissance incluse et optique en retrait équipée d'une grille à lamelles anti-éblouissement. Alimentation 220-240 V ON-OFF et variable 1-10 V et DALI. Le coffrage d'installation obligatoire doit être commandé séparément. Précâblé avec les connecteurs rapides H₂O Stop prise/fiche inclus. ACT (Anti Corrosion Treatment) sur demande.

High-power LED source included and rear lenses equipped with anti-glare diffuser grille. 1-10V or DALI on-off and dimmable 220-240V power supply. Compulsory installation box to be ordered separately. Pre-wired with H₂O Stop quick connectors, plug/socket included. ACT (Anti-Corrosion Treatment) upon request.

Optic Spot 16°

Power Led: 12,5W - LED 1304 lm ≠ OUTPUT 702 lm - 2200K/CRI 80 / 12,5W - LED 1352 lm ≠ OUTPUT 728 lm - 2700K/CRI 80 / 12,5W - LED 1449 lm ≠ OUTPUT 780 lm - 3000K/CRI 80 / 12,5W - LED 1497 lm ≠ OUTPUT 806 lm - 4000K/CRI 80

2200K	2700K	3000K	4000K		
Non Dimmable	Non Dimmable	Non Dimmable	Non Dimmable		
● F017J1HA006	● F017J2HA006	● F017J3HA006	● F017J4HA006	655,00 €	
● F017J1HA033	● F017J2HA033	● F017J3HA033	● F017J4HA033	655,00 €	
1-10V	1-10V	1-10V	1-10V		
● F017J1HB006	● F017J2HB006	● F017J3HB006	● F017J4HB006	680,00 €	
● F017J1HB033	● F017J2HB033	● F017J3HB033	● F017J4HB033	680,00 €	
Dali	Dali	Dali	Dali		
● F017J1HD006	● F017J2HD006	● F017J3HD006	● F017J4HD006	691,00 €	
● F017J1HD033	● F017J2HD033	● F017J3HD033	● F017J4HD033	691,00 €	

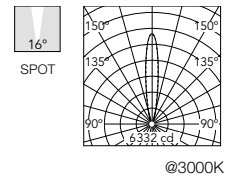

Optic Medium 25°

Power Led: 12,5W - LED 1304 lm ≠ OUTPUT 744 lm - 2200K/CRI 80 / 12,5W - LED 1352 lm ≠ OUTPUT 772 lm - 2700K/CRI 80 / 12,5W - LED 1449 lm ≠ OUTPUT 827 lm - 3000K/CRI 80 / 12,5W - LED 1497 lm ≠ OUTPUT 854 lm - 4000K/CRI 80

2200K	2700K	3000K	4000K		
Non Dimmable	Non Dimmable	Non Dimmable	Non Dimmable		
● F017J1JA006	● F017J2JA006	● F017J3JA006	● F017J4JA006	655,00 €	
● F017J1JA033	● F017J2JA033	● F017J3JA033	● F017J4JA033	655,00 €	
1-10V	1-10V	1-10V	1-10V		
● F017J1JB006	● F017J2JB006	● F017J3JB006	● F017J4JB006	680,00 €	
● F017J1JB033	● F017J2JB033	● F017J3JB033	● F017J4JB033	680,00 €	
Dali	Dali	Dali	Dali		
● F017J1JD006	● F017J2JD006	● F017J3JD006	● F017J4JD006	691,00 €	
● F017J1JD033	● F017J2JD033	● F017J3JD033	● F017J4JD033	691,00 €	

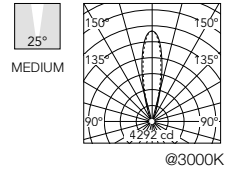

Optic Flood 39°

Power Led: 12,5W - LED 1304 lm ≠ OUTPUT 576 lm - 2200K/CRI 80 / 12,5W - LED 1352 lm ≠ OUTPUT 597 lm - 2700K/CRI 80 / 12,5W - LED 1449 lm ≠ OUTPUT 639 lm - 3000K/CRI 80 / 12,5W - LED 1497 lm ≠ OUTPUT 661 lm - 4000K/CRI 80

2200K	2700K	3000K	4000K		
Non Dimmable	Non Dimmable	Non Dimmable	Non Dimmable		
● F017J1KA006	● F017J2KA006	● F017J3KA006	● F017J4KA006	655,00 €	
● F017J1KA033	● F017J2KA033	● F017J3KA033	● F017J4KA033	655,00 €	
1-10V	1-10V	1-10V	1-10V		
● F017J1KB006	● F017J2KB006	● F017J3KB006	● F017J4KB006	680,00 €	
● F017J1KB033	● F017J2KB033	● F017J3KB033	● F017J4KB033	680,00 €	
Dali	Dali	Dali	Dali		
● F017J1KD006	● F017J2KD006	● F017J3KD006	● F017J4KD006	691,00 €	
● F017J1KD033	● F017J2KD033	● F017J3KD033	● F017J4KD033	691,00 €	

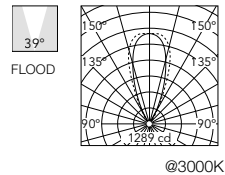

Optic Elliptical 13° x 40°

Power Led: 12,5W - LED 1304 lm ≠ OUTPUT 574 lm - 2200K/CRI 80 / 12,5W - LED 1352 lm ≠ OUTPUT 595 lm - 2700K/CRI 80 / 12,5W - LED 1449 lm ≠ OUTPUT 638 lm - 3000K/CRI 80 / 12,5W - LED 1497 lm ≠ OUTPUT 659 lm - 4000K/CRI 80

2200K	2700K	3000K	4000K		
Non Dimmable	Non Dimmable	Non Dimmable	Non Dimmable		
● F017J1LA006	● F017J2LA006	● F017J3LA006	● F017J4LA006	655,00 €	
● F017J1LA033	● F017J2LA033	● F017J3LA033	● F017J4LA033	655,00 €	
1-10V	1-10V	1-10V	1-10V		
● F017J1LB006	● F017J2LB006	● F017J3LB006	● F017J4LB006	680,00 €	
● F017J1LB033	● F017J2LB033	● F017J3LB033	● F017J4LB033	680,00 €	
Dali	Dali	Dali	Dali		
● F017J1LD006	● F017J2LD006	● F017J3LD006	● F017J4LD006	691,00 €	
● F017J1LD033	● F017J2LD033	● F017J3LD033	● F017J4LD033	691,00 €	

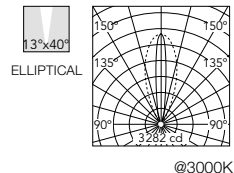

Ingraze Fixed Frameless + Asymmetric Louvre L 400

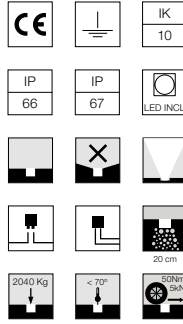
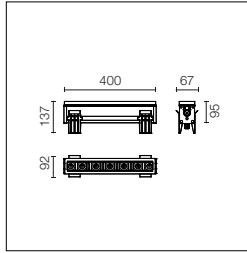

Source LED haute puissance incluse et optique en retrait équipée d'une grille à lamelles asymétrique anti-éblouissement. Alimentation 220-240 V ON-OFF et variable 1-10 V et DALI.
Le coffrage d'installation obligatoire doit être commandé séparément. Précâblé avec les connecteurs rapides H₂O Stop prise/fiche inclus. ACT (Anti Corrosion Treatment) sur demande.

High-power LED source included and rear lenses equipped with anti-glare asymmetrical diffuser grille. 1-10V or DALI on-off and dimmable 220-240V power supply. Compulsory installation box to be ordered separately. Pre-wired with H₂O Stop quick connectors, plug/socket included. ACT (Anti-Corrosion Treatment) upon request.

Optic Spot 15°

Power Led: 12,5W - LED 1304 lm ≠ OUTPUT 334 lm - 2200K/CRI 80 / 12,5W - LED 1352 lm ≠ OUTPUT 346 lm - 2700K/CRI 80 / 12,5W - LED 1449 lm ≠ OUTPUT 371 lm - 3000K/CRI 80 / 12,5W - LED 1497 lm ≠ OUTPUT 383 lm - 4000K/CRI 80

2200K

Non Dimmable

- F017J1QA006
- F017J1QA033
- 1-10V
- F017J1QB006
- F017J1QB033
- Dali
- F017J1QD006
- F017J1QD033

2700K

Non Dimmable

- F017J2QA006
- F017J2QA033
- 1-10V
- F017J2QB006
- F017J2QB033
- Dali
- F017J2QD006
- F017J2QD033

3000K

Non Dimmable

- F017J3QA006
- F017J3QA033
- 1-10V
- F017J3QB006
- F017J3QB033
- Dali
- F017J3QD006
- F017J3QD033

4000K

Non Dimmable

- F017J4QA006 655,00 €
- F017J4QA033 655,00 €
- 1-10V
- F017J4QB006 680,00 €
- F017J4QB033 680,00 €
- Dali
- F017J4QD006 691,00 €
- F017J4QD033 691,00 €



SPOT

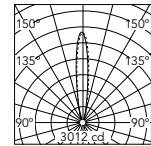

@3000K

Beam Angle: 15°	h(m)	E(lx)	D(m)
1	3010	0.25	
2	753	0.51	
3	334	0.76	
4	188	1.02	
5	120	1.27	

Optic Medium 25°

Power Led: 12,5W - LED 1304 lm ≠ OUTPUT 353 lm - 2200K/CRI 80 / 12,5W - LED 1352 lm ≠ OUTPUT 367 lm - 2700K/CRI 80 / 12,5W - LED 1449 lm ≠ OUTPUT 393 lm - 3000K/CRI 80 / 12,5W - LED 1497 lm ≠ OUTPUT 406 lm - 4000K/CRI 80

2200K

Non Dimmable

- F017J1RA006
- F017J1RA033
- 1-10V
- F017J1RB006
- F017J1RB033
- Dali
- F017J1RD006
- F017J1RD033

2700K

Non Dimmable

- F017J2RA006
- F017J2RA033
- 1-10V
- F017J2RB006
- F017J2RB033
- Dali
- F017J2RD006
- F017J2RD033

3000K

Non Dimmable

- F017J3RA006
- F017J3RA033
- 1-10V
- F017J3RB006
- F017J3RB033
- Dali
- F017J3RD006
- F017J3RD033

4000K

Non Dimmable

- F017J4RA006 655,00 €
- F017J4RA033 655,00 €
- 1-10V
- F017J4RB006 680,00 €
- F017J4RB033 680,00 €
- Dali
- F017J4RD006 691,00 €
- F017J4RD033 691,00 €



MEDIUM

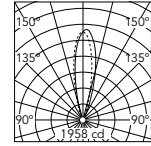

@3000K

Beam Angle: 25°	h(m)	E(lx)	D(m)
1	1955	0.45	
2	489	0.89	
3	217	1.34	
4	122	1.78	
5	78	2.23	

Optic Flood 42°

Power Led: 12,5W - LED 1304 lm ≠ OUTPUT 283 lm - 2200K/CRI 80 / 12,5W - LED 1352 lm ≠ OUTPUT 294 lm - 2700K/CRI 80 / 12,5W - LED 1449 lm ≠ OUTPUT 314 lm - 3000K/CRI 80 / 12,5W - LED 1497 lm ≠ OUTPUT 325 lm - 4000K/CRI 80

2200K

Non Dimmable

- F017J1SA006
- F017J1SA033
- 1-10V
- F017J1SB006
- F017J1SB033
- Dali
- F017J1SD006
- F017J1SD033

2700K

Non Dimmable

- F017J2SA006
- F017J2SA033
- 1-10V
- F017J2SB006
- F017J2SB033
- Dali
- F017J2SD006
- F017J2SD033

3000K

Non Dimmable

- F017J3SA006
- F017J3SA033
- 1-10V
- F017J3SB006
- F017J3SB033
- Dali
- F017J3SD006
- F017J3SD033

4000K

Non Dimmable

- F017J4SA006 655,00 €
- F017J4SA033 655,00 €
- 1-10V
- F017J4SB006 680,00 €
- F017J4SB033 680,00 €
- Dali
- F017J4SD006 691,00 €
- F017J4SD033 691,00 €



FLOOD

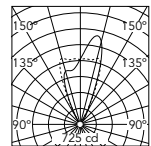

@3000K

Beam Angle: 42°	h(m)	E(lx)	D(m)
1	688	0.76	
2	172	1.51	
3	76	2.27	
4	43	3.03	
5	28	3.78	

Optic Elliptical 12° x 40°

Power Led: 12,5W - LED 1304 lm ≠ OUTPUT 271 lm - 2200K/CRI 80 / 12,5W - LED 1352 lm ≠ OUTPUT 281 lm - 2700K/CRI 80 / 12,5W - LED 1449 lm ≠ OUTPUT 301 lm - 3000K/CRI 80 / 12,5W - LED 1497 lm ≠ OUTPUT 311 lm - 4000K/CRI 80

2200K

Non Dimmable

- F017J1TA006
- F017J1TA033
- 1-10V
- F017J1TB006
- F017J1TB033
- Dali
- F017J1TD006
- F017J1TD033

2700K

Non Dimmable

- F017J2TA006
- F017J2TA033
- 1-10V
- F017J2TB006
- F017J2TB033
- Dali
- F017J2TD006
- F017J2TD033

3000K

Non Dimmable

- F017J3TA006
- F017J3TA033
- 1-10V
- F017J3TB006
- F017J3TB033
- Dali
- F017J3TD006
- F017J3TD033

4000K

Non Dimmable

- F017J4TA006 655,00 €
- F017J4TA033 655,00 €
- 1-10V
- F017J4TB006 680,00 €
- F017J4TB033 680,00 €
- Dali
- F017J4TD006 691,00 €
- F017J4TD033 691,00 €



ELLIPTICAL

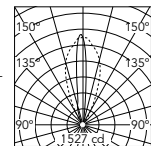

@3000K

Beam Angle: 12°	h(m)	E(lx)	D(m)
1	1526	0.21	
2	382	0.42	
3	170	0.62	
4	95	0.83	
5	61	1.04	

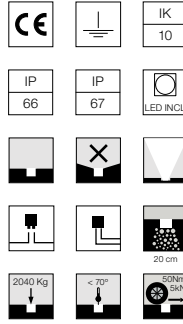
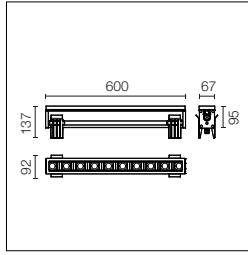

Source LED haute puissance incluse et optique en retrait.
Alimentation 220-240 V ON-OFF et variable 1-10 V et DALI.
Le coffrage d'installation obligatoire doit être commandé séparément.
Précâblé avec les connecteurs rapides H₂O Stop prise/fiche inclus.
ACT (Anti Corrosion Treatment) sur demande.

High-power LED source included and rear lenses. 1-10V or DALI on-off and dimmable 220-240V power supply.
Compulsory installation box to be ordered separately.
Pre-wired with H₂O Stop quick connectors, plug/socket included.
ACT (Anti-Corrosion Treatment) upon request.

Optic Spot 16°

Power Led: 17W - LED 1863 lm ≠ OUTPUT 1368 lm - 2200K/CRI 80 / 17W - LED 1932 lm ≠ OUTPUT 1419 lm - 2700K/CRI 80 / 17W - LED 2070 lm ≠ OUTPUT 1520 lm - 3000K/CRI 80 / 17W - LED 2139 lm ≠ OUTPUT 1571 lm - 4000K/CRI 80

2200K	2700K	3000K	4000K	
Non Dimmable	Non Dimmable	Non Dimmable	Non Dimmable	
● F017K1AA006	● F017K2AA006	● F017K3AA006	● F017K4AA006	828,00 €
● F017K1AA033	● F017K2AA033	● F017K3AA033	● F017K4AA033	828,00 €
1-10V	1-10V	1-10V	1-10V	
● F017K1AB006	● F017K2AB006	● F017K3AB006	● F017K4AB006	831,00 €
● F017K1AB033	● F017K2AB033	● F017K3AB033	● F017K4AB033	831,00 €
Dali	Dali	Dali	Dali	
● F017K1AD006	● F017K2AD006	● F017K3AD006	● F017K4AD006	874,00 €
● F017K1AD033	● F017K2AD033	● F017K3AD033	● F017K4AD033	874,00 €

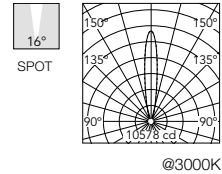

Beam Angle: 16°

h(m)	E(lx)	D(m)
1	10578	0.27
2	2644	0.55
3	1175	0.82
4	661	1.09
5	423	1.37

Optic Medium 25°

Power Led: 17W - LED 1863 lm ≠ OUTPUT 1473 lm - 2200K/CRI 80 / 17W - LED 1932 lm ≠ OUTPUT 1527 lm - 2700K/CRI 80 / 17W - LED 2070 lm ≠ OUTPUT 1636 lm - 3000K/CRI 80 / 17W - LED 2139 lm ≠ OUTPUT 1691 lm - 4000K/CRI 80

2200K	2700K	3000K	4000K	
Non Dimmable	Non Dimmable	Non Dimmable	Non Dimmable	
● F017K1BA006	● F017K2BA006	● F017K3BA006	● F017K4BA006	828,00 €
● F017K1BA033	● F017K2BA033	● F017K3BA033	● F017K4BA033	828,00 €
1-10V	1-10V	1-10V	1-10V	
● F017K1BB006	● F017K2BB006	● F017K3BB006	● F017K4BB006	831,00 €
● F017K1BB033	● F017K2BB033	● F017K3BB033	● F017K4BB033	831,00 €
Dali	Dali	Dali	Dali	
● F017K1BD006	● F017K2BD006	● F017K3BD006	● F017K4BD006	874,00 €
● F017K1BD033	● F017K2BD033	● F017K3BD033	● F017K4BD033	874,00 €

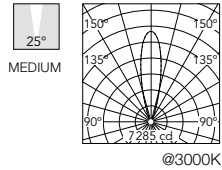

Beam Angle: 25°

h(m)	E(lx)	D(m)
1	7285	0.44
2	1821	0.88
3	809	1.32
4	455	1.76
5	291	2.20

Optic Flood 46°

Power Led: 17W - LED 1863 lm ≠ OUTPUT 1283 lm - 2200K/CRI 80 / 17W - LED 1932 lm ≠ OUTPUT 1330 lm - 2700K/CRI 80 / 17W - LED 2070 lm ≠ OUTPUT 1425 lm - 3000K/CRI 80 / 17W - LED 2139 lm ≠ OUTPUT 1473 lm - 4000K/CRI 80

2200K	2700K	3000K	4000K	
Non Dimmable	Non Dimmable	Non Dimmable	Non Dimmable	
● F017K1CA006	● F017K2CA006	● F017K3CA006	● F017K4CA006	828,00 €
● F017K1CA033	● F017K2CA033	● F017K3CA033	● F017K4CA033	828,00 €
1-10V	1-10V	1-10V	1-10V	
● F017K1CB006	● F017K2CB006	● F017K3CB006	● F017K4CB006	831,00 €
● F017K1CB033	● F017K2CB033	● F017K3CB033	● F017K4CB033	831,00 €
Dali	Dali	Dali	Dali	
● F017K1CD006	● F017K2CD006	● F017K3CD006	● F017K4CD006	874,00 €
● F017K1CD033	● F017K2CD033	● F017K3CD033	● F017K4CD033	874,00 €

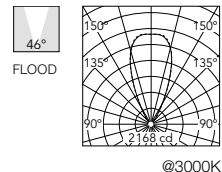

Beam Angle: 46°

h(m)	E(lx)	D(m)
1	2158	0.85
2	539	1.71
3	240	2.56
4	135	3.42
5	86	4.27

Optic Elliptical 12° x 50°

Power Led: 17W - LED 1863 lm ≠ OUTPUT 1286 lm - 2200K/CRI 80 / 17W - LED 1932 lm ≠ OUTPUT 1334 lm - 2700K/CRI 80 / 17W - LED 2070 lm ≠ OUTPUT 1429 lm - 3000K/CRI 80 / 17W - LED 2139 lm ≠ OUTPUT 1477 lm - 4000K/CRI 80

2200K	2700K	3000K	4000K	
Non Dimmable	Non Dimmable	Non Dimmable	Non Dimmable	
● F017K1DA006	● F017K2DA006	● F017K3DA006	● F017K4DA006	828,00 €
● F017K1DA033	● F017K2DA033	● F017K3DA033	● F017K4DA033	828,00 €
1-10V	1-10V	1-10V	1-10V	
● F017K1DB006	● F017K2DB006	● F017K3DB006	● F017K4DB006	831,00 €
● F017K1DB033	● F017K2DB033	● F017K3DB033	● F017K4DB033	831,00 €
Dali	Dali	Dali	Dali	
● F017K1DD006	● F017K2DD006	● F017K3DD006	● F017K4DD006	874,00 €
● F017K1DD033	● F017K2DD033	● F017K3DD033	● F017K4DD033	874,00 €

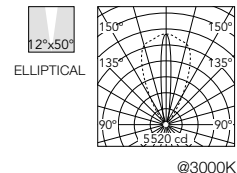

Beam Angle: 12°

h(m)	E(lx)	D(m)
1	5519	0.22
2	1380	0.44
3	613	0.66
4	345	0.87
5	221	1.09

Ingraze Fixed Frameless + Linear Louvre L 600

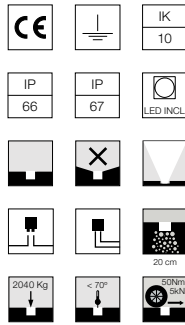
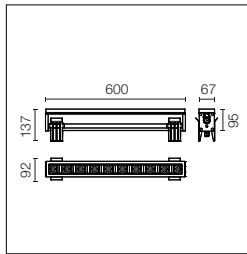

Source LED haute puissance incluse et optique en retrait équipée d'une grille à lamelles anti-éblouissement. Alimentation 220-240 V ON-OFF et variable 1-10 V et DALI. Le coffrage d'installation obligatoire doit être commandé séparément. Précâblé avec les connecteurs rapides H₂O Stop prise/fiche inclus. ACT (Anti Corrosion Treatment) sur demande.

High-power LED source included and rear lenses equipped with anti-glare diffuser grille. 1-10V or DALI on-off and dimmable 220-240V power supply. Compulsory installation box to be ordered separately. Pre-wired with H₂O Stop quick connectors, plug/socket included. ACT (Anti-Corrosion Treatment) upon request.

Optic Spot 16°

Power Led: 17W - LED 1863 lm ≠ OUTPUT 1003 lm - 2200K/CRI 80 / 17W - LED 1932 lm ≠ OUTPUT 1040 lm - 2700K/CRI 80 / 17W - LED 2070 lm ≠ OUTPUT 1115 lm - 3000K/CRI 80 / 17W - LED 2139 lm ≠ OUTPUT 1152 lm - 4000K/CRI 80

2200K

Non Dimmable

- F017K1HA006
- F017K1HA033
- 1-10V
- F017K1HB006
- F017K1HB033
- Dali
- F017K1HD006
- F017K1HD033

2700K

Non Dimmable

- F017K2HA006
- F017K2HA033
- 1-10V
- F017K2HB006
- F017K2HB033
- Dali
- F017K2HD006
- F017K2HD033

3000K

Non Dimmable

- F017K3HA006
- F017K3HA033
- 1-10V
- F017K3HB006
- F017K3HB033
- Dali
- F017K3HD006
- F017K3HD033

4000K

Non Dimmable

- F017K4HA006 838,00 €
- F017K4HA033 838,00 €
- 1-10V
- F017K4HB006 841,00 €
- F017K4HB033 841,00 €
- Dali
- F017K4HD006 884,00 €
- F017K4HD033 884,00 €

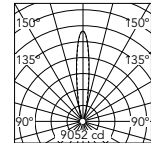

Beam Angle: 16°	h(m)	E(lx)	Dxm
1	9052	0.28	
2	2263	0.56	
3	1006	0.83	
4	566	1.11	
5	362	1.39	

@3000K

Optic Medium 25°

Power Led: 17W - LED 1863 lm ≠ OUTPUT 1063 lm - 2200K/CRI 80 / 17W - LED 1932 lm ≠ OUTPUT 1102 lm - 2700K/CRI 80 / 17W - LED 2070 lm ≠ OUTPUT 1181 lm - 3000K/CRI 80 / 17W - LED 2139 lm ≠ OUTPUT 1220 lm - 4000K/CRI 80

2200K

Non Dimmable

- F017K1JA006
- F017K1JA033
- 1-10V
- F017K1JB006
- F017K1JB033
- Dali
- F017K1JD006
- F017K1JD033

2700K

Non Dimmable

- F017K2JA006
- F017K2JA033
- 1-10V
- F017K2JB006
- F017K2JB033
- Dali
- F017K2JD006
- F017K2JD033

3000K

Non Dimmable

- F017K3JA006
- F017K3JA033
- 1-10V
- F017K3JB006
- F017K3JB033
- Dali
- F017K3JD006
- F017K3JD033

4000K

Non Dimmable

- F017K4JA006 838,00 €
- F017K4JA033 838,00 €
- 1-10V
- F017K4JB006 841,00 €
- F017K4JB033 841,00 €
- Dali
- F017K4JD006 884,00 €
- F017K4JD033 884,00 €

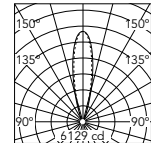

Beam Angle: 25°	h(m)	E(lx)	Dxm
1	6129	0.44	
2	1532	0.87	
3	681	1.31	
4	383	1.74	
5	245	2.18	

@3000K

Optic Flood 39°

Power Led: 17W - LED 1863 lm ≠ OUTPUT 820 lm - 2200K/CRI 80 / 17W - LED 1932 lm ≠ OUTPUT 850 lm - 2700K/CRI 80 / 17W - LED 2070 lm ≠ OUTPUT 911 lm - 3000K/CRI 80 / 17W - LED 2139 lm ≠ OUTPUT 944 lm - 4000K/CRI 80

2200K

Non Dimmable

- F017K1KA006
- F017K1KA033
- 1-10V
- F017K1KB006
- F017K1KB033
- Dali
- F017K1KD006
- F017K1KD033

2700K

Non Dimmable

- F017K2KA006
- F017K2KA033
- 1-10V
- F017K2KB006
- F017K2KB033
- Dali
- F017K2KD006
- F017K2KD033

3000K

Non Dimmable

- F017K3KA006
- F017K3KA033
- 1-10V
- F017K3KB006
- F017K3KB033
- Dali
- F017K3KD006
- F017K3KD033

4000K

Non Dimmable

- F017K4KA006 838,00 €
- F017K4KA033 838,00 €
- 1-10V
- F017K4KB006 841,00 €
- F017K4KB033 841,00 €
- Dali
- F017K4KD006 884,00 €
- F017K4KD033 884,00 €

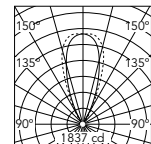

Beam Angle: 39°	h(m)	E(lx)	Dxm
1	1832	0.71	
2	458	1.43	
3	204	2.14	
4	115	2.86	
5	73	3.57	

@3000K

Optic Elliptical 13° x 40°

Power Led: 17W - LED 1863 lm ≠ OUTPUT 820 lm - 2200K/CRI 80 / 17W - LED 1932 lm ≠ OUTPUT 850 lm - 2700K/CRI 80 / 17W - LED 2070 lm ≠ OUTPUT 911 lm - 3000K/CRI 80 / 17W - LED 2139 lm ≠ OUTPUT 941 lm - 4000K/CRI 80

2200K

Non Dimmable

- F017K1LA006
- F017K1LA033
- 1-10V
- F017K1LB006
- F017K1LB033
- Dali
- F017K1LD006
- F017K1LD033

2700K

Non Dimmable

- F017K2LA006
- F017K2LA033
- 1-10V
- F017K2LB006
- F017K2LB033
- Dali
- F017K2LD006
- F017K2LD033

3000K

Non Dimmable

- F017K3LA006
- F017K3LA033
- 1-10V
- F017K3LB006
- F017K3LB033
- Dali
- F017K3LD006
- F017K3LD033

4000K

Non Dimmable

- F017K4LA006 838,00 €
- F017K4LA033 838,00 €
- 1-10V
- F017K4LB006 841,00 €
- F017K4LB033 841,00 €
- Dali
- F017K4LD006 884,00 €
- F017K4LD033 884,00 €

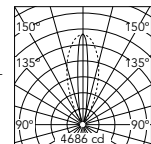

Beam Angle: 13°	h(m)	E(lx)	Dxm
1	4686	0.22	
2	1172	0.44	
3	521	0.67	
4	293	0.89	
5	187	1.11	

@3000K

Ingraze Fixed Frameless + Asymmetric Louvre L 600

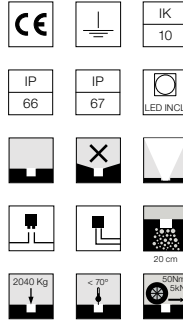
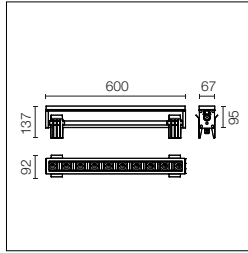

Source LED haute puissance incluse et optique en retrait équipée d'une grille à lamelles asymétrique anti-éblouissement. Alimentation 220-240 V ON-OFF et variable 1-10 V et DALI.
Le coffrage d'installation obligatoire doit être commandé séparément. Précâblé avec les connecteurs rapides H₂O Stop prise/fiche inclus. ACT (Anti Corrosion Treatment) sur demande.

High-power LED source included and rear lenses equipped with anti-glare asymmetrical diffuser grille. 1-10V or DALI on-off and dimmable 220-240V power supply. Compulsory installation box to be ordered separately. Pre-wired with H₂O Stop quick connectors, plug/socket included. ACT (Anti-Corrosion Treatment) upon request.

Optic Spot 15°

Power Led: 17W - LED 1863 lm ≠ OUTPUT 477 lm - 2200K/CRI 80 / 17W - LED 1932 lm ≠ OUTPUT 495 lm - 2700K/CRI 80 / 17W - LED 2070 lm ≠ OUTPUT 530 lm - 3000K/CRI 80 / 17W - LED 2139 lm ≠ OUTPUT 548 lm - 4000K/CRI 80

2200K	2700K	3000K	4000K	
Non Dimmable	Non Dimmable	Non Dimmable	Non Dimmable	
● F017K1QA006	● F017K2QA006	● F017K3QA006	● F017K4QA006	838,00 €
● F017K1QA033	● F017K2QA033	● F017K3QA033	● F017K4QA033	838,00 €
1-10V	1-10V	1-10V	1-10V	
● F017K1QB006	● F017K2QB006	● F017K3QB006	● F017K4QB006	841,00 €
● F017K1QB033	● F017K2QB033	● F017K3QB033	● F017K4QB033	841,00 €
Dali	Dali	Dali	Dali	
● F017K1QD006	● F017K2QD006	● F017K3QD006	● F017K4QD006	884,00 €
● F017K1QD033	● F017K2QD033	● F017K3QD033	● F017K4QD033	884,00 €

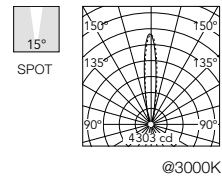

Beam Angle: 15°

h(m)	E(lx)	D(m)
1	4300	0.25
2	1075	0.51
3	478	0.76
4	269	1.02
5	172	1.27

Optic Medium 25°

Power Led: 17W - LED 1863 lm ≠ OUTPUT 505 lm - 2200K/CRI 80 / 17W - LED 1932 lm ≠ OUTPUT 523 lm - 2700K/CRI 80 / 17W - LED 2070 lm ≠ OUTPUT 561 lm - 3000K/CRI 80 / 17W - LED 2139 lm ≠ OUTPUT 579 lm - 4000K/CRI 80

2200K	2700K	3000K	4000K	
Non Dimmable	Non Dimmable	Non Dimmable	Non Dimmable	
● F017K1RA006	● F017K2RA006	● F017K3RA006	● F017K4RA006	838,00 €
● F017K1RA033	● F017K2RA033	● F017K3RA033	● F017K4RA033	838,00 €
1-10V	1-10V	1-10V	1-10V	
● F017K1RB006	● F017K2RB006	● F017K3RB006	● F017K4RB006	841,00 €
● F017K1RB033	● F017K2RB033	● F017K3RB033	● F017K4RB033	841,00 €
Dali	Dali	Dali	Dali	
● F017K1RD006	● F017K2RD006	● F017K3RD006	● F017K4RD006	884,00 €
● F017K1RD033	● F017K2RD033	● F017K3RD033	● F017K4RD033	884,00 €

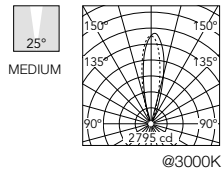

Beam Angle: 25°

h(m)	E(lx)	D(m)
1	2790	0.45
2	698	0.89
3	310	1.34
4	174	1.78
5	112	2.23

Optic Flood 42°

Power Led: 17W - LED 1863 lm ≠ OUTPUT 404 lm - 2200K/CRI 80 / 17W - LED 1932 lm ≠ OUTPUT 419 lm - 2700K/CRI 80 / 17W - LED 2070 lm ≠ OUTPUT 449 lm - 3000K/CRI 80 / 17W - LED 2139 lm ≠ OUTPUT 464 lm - 4000K/CRI 80

2200K	2700K	3000K	4000K	
Non Dimmable	Non Dimmable	Non Dimmable	Non Dimmable	
● F017K1SA006	● F017K2SA006	● F017K3SA006	● F017K4SA006	838,00 €
● F017K1SA033	● F017K2SA033	● F017K3SA033	● F017K4SA033	838,00 €
1-10V	1-10V	1-10V	1-10V	
● F017K1SB006	● F017K2SB006	● F017K3SB006	● F017K4SB006	841,00 €
● F017K1SB033	● F017K2SB033	● F017K3SB033	● F017K4SB033	841,00 €
Dali	Dali	Dali	Dali	
● F017K1SD006	● F017K2SD006	● F017K3SD006	● F017K4SD006	884,00 €
● F017K1SD033	● F017K2SD033	● F017K3SD033	● F017K4SD033	884,00 €

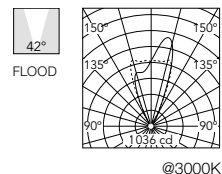

Beam Angle: 42°

h(m)	E(lx)	D(m)
1	983	0.76
2	246	1.51
3	109	2.27
4	61	3.03
5	39	3.78

Optic Elliptical 12° x 40°

Power Led: 17W - LED 1863 lm ≠ OUTPUT 387 lm - 2200K/CRI 80 / 17W - LED 1932 lm ≠ OUTPUT 401 lm - 2700K/CRI 80 / 17W - LED 2070 lm ≠ OUTPUT 430 lm - 3000K/CRI 80 / 17W - LED 2139 lm ≠ OUTPUT 444 lm - 4000K/CRI 80

2200K	2700K	3000K	4000K	
Non Dimmable	Non Dimmable	Non Dimmable	Non Dimmable	
● F017K1TA006	● F017K2TA006	● F017K3TA006	● F017K4TA006	838,00 €
● F017K1TA033	● F017K2TA033	● F017K3TA033	● F017K4TA033	838,00 €
1-10V	1-10V	1-10V	1-10V	
● F017K1TB006	● F017K2TB006	● F017K3TB006	● F017K4TB006	841,00 €
● F017K1TB033	● F017K2TB033	● F017K3TB033	● F017K4TB033	841,00 €
Dali	Dali	Dali	Dali	
● F017K1TD006	● F017K2TD006	● F017K3TD006	● F017K4TD006	884,00 €
● F017K1TD033	● F017K2TD033	● F017K3TD033	● F017K4TD033	884,00 €

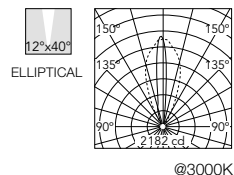

Beam Angle: 12°

h(m)	E(lx)	D(m)
1	2181	0.21
2	545	0.42
3	242	0.62
4	136	0.83
5	87	1.04

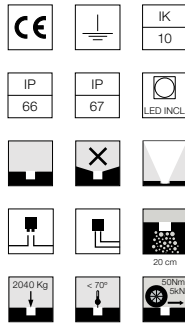
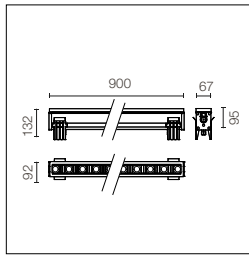

Source LED haute puissance incluse et optique en retrait.
Alimentation 220-240 V ON-OFF et variable 1-10 V et DALI.
Le coffrage d'installation obligatoire doit être commandé séparément.
Précâblé avec les connecteurs rapides H₂O Stop prise/fiche inclus.
ACT (Anti Corrosion Treatment) sur demande.

High-power LED source included and rear lenses. 1-10V or DALI on-off and dimmable 220-240V power supply.
Compulsory installation box to be ordered separately.
Pre-wired with H₂O Stop quick connectors, plug/socket included.
ACT (Anti-Corrosion Treatment) upon request.

Optic Spot 16°

Power Led: 26W - LED 2795 lm ≠ OUTPUT 2052 lm - 2200K/CRI 80 / 26W - LED 2898 lm ≠ OUTPUT 2128 lm - 2700K/CRI 80 / 26W - LED 3105 lm ≠ OUTPUT 2280 lm - 3000K/CRI 80 / 26W - LED 3209 lm ≠ OUTPUT 2536 lm - 4000K/CRI 80

2200K

Non Dimmable

- F017L1AA006
- F017L1AA033
- 1-10V
- F017L1AB006
- F017L1AB033
- Dali
- F017L1AD006
- F017L1AD033

2700K

Non Dimmable

- F017L2AA006
- F017L2AA033
- 1-10V
- F017L2AB006
- F017L2AB033
- Dali
- F017L2AD006
- F017L2AD033

3000K

Non Dimmable

- F017L3AA006
- F017L3AA033
- 1-10V
- F017L3AB006
- F017L3AB033
- Dali
- F017L3AD006
- F017L3AD033

4000K

Non Dimmable

- F017L4AA006 942,00 €
- F017L4AA033 942,00 €
- 1-10V
- F017L4AB006 979,00 €
- F017L4AB033 979,00 €
- Dali
- F017L4AD006 997,00 €
- F017L4AD033 997,00 €

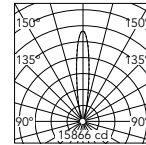

Beam Angle: 16°

h(m)	E(lx)	D(m)
1	15866	0.27
2	3967	0.55
3	1763	0.82
4	992	1.09
5	635	1.37

@3000K

Optic Medium 25°

Power Led: 26W - LED 2795 lm ≠ OUTPUT 2209 lm - 2200K/CRI 80 / 26W - LED 2898 lm ≠ OUTPUT 2291 lm - 2700K/CRI 80 / 26W - LED 3105 lm ≠ OUTPUT 2454 lm - 3000K/CRI 80 / 26W - LED 3209 lm ≠ OUTPUT 2536 lm - 4000K/CRI 80

2200K

Non Dimmable

- F017L1BA006
- F017L1BA033
- 1-10V
- F017L1BB006
- F017L1BB033
- Dali
- F017L1BD006
- F017L1BD033

2700K

Non Dimmable

- F017L2BA006
- F017L2BA033
- 1-10V
- F017L2BB006
- F017L2BB033
- Dali
- F017L2BD006
- F017L2BD033

3000K

Non Dimmable

- F017L3BA006
- F017L3BA033
- 1-10V
- F017L3BB006
- F017L3BB033
- Dali
- F017L3BD006
- F017L3BD033

4000K

Non Dimmable

- F017L4BA006 942,00 €
- F017L4BA033 942,00 €
- 1-10V
- F017L4BB006 979,00 €
- F017L4BB033 979,00 €
- Dali
- F017L4BD006 997,00 €
- F017L4BD033 997,00 €

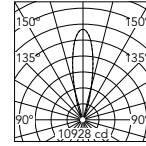

Beam Angle: 25°

h(m)	E(lx)	D(m)
1	10928	0.44
2	2732	0.88
3	1214	1.32
4	683	1.76
5	437	2.20

@3000K

Optic Flood 46°

Power Led: 26W - LED 2795 lm ≠ OUTPUT 1924 lm - 2200K/CRI 80 / 26W - LED 2898 lm ≠ OUTPUT 1995 lm - 2700K/CRI 80 / 26W - LED 3105 lm ≠ OUTPUT 2138 lm - 3000K/CRI 80 / 26W - LED 3209 lm ≠ OUTPUT 2209 lm - 4000K/CRI 80

2200K

Non Dimmable

- F017L1CA006
- F017L1CA033
- 1-10V
- F017L1CB006
- F017L1CB033
- Dali
- F017L1CD006
- F017L1CD033

2700K

Non Dimmable

- F017L2CA006
- F017L2CA033
- 1-10V
- F017L2CB006
- F017L2CB033
- Dali
- F017L2CD006
- F017L2CD033

3000K

Non Dimmable

- F017L3CA006
- F017L3CA033
- 1-10V
- F017L3CB006
- F017L3CB033
- Dali
- F017L3CD006
- F017L3CD033

4000K

Non Dimmable

- F017L4CA006 942,00 €
- F017L4CA033 942,00 €
- 1-10V
- F017L4CB006 979,00 €
- F017L4CB033 979,00 €
- Dali
- F017L4CD006 997,00 €
- F017L4CD033 997,00 €

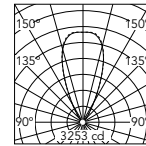

Beam Angle: 46°

h(m)	E(lx)	D(m)
1	3238	0.85
2	809	1.71
3	360	2.56
4	202	3.42
5	130	4.27

@3000K

Optic Elliptical 12° x 50°

Power Led: 26W - LED 2795 lm ≠ OUTPUT 1929 lm - 2200K/CRI 80 / 26W - LED 2898 lm ≠ OUTPUT 2001 lm - 2700K/CRI 80 / 26W - LED 3105 lm ≠ OUTPUT 2144 lm - 3000K/CRI 80 / 26W - LED 3209 lm ≠ OUTPUT 2215 lm - 4000K/CRI 80

2200K

Non Dimmable

- F017L1DA006
- F017L1DA033
- 1-10V
- F017L1DB006
- F017L1DB033
- Dali
- F017L1DD006
- F017L1DD033

2700K

Non Dimmable

- F017L2DA006
- F017L2DA033
- 1-10V
- F017L2DB006
- F017L2DB033
- Dali
- F017L2DD006
- F017L2DD033

3000K

Non Dimmable

- F017L3DA006
- F017L3DA033
- 1-10V
- F017L3DB006
- F017L3DB033
- Dali
- F017L3DD006
- F017L3DD033

4000K

Non Dimmable

- F017L4DA006 942,00 €
- F017L4DA033 942,00 €
- 1-10V
- F017L4DB006 979,00 €
- F017L4DB033 979,00 €
- Dali
- F017L4DD006 997,00 €
- F017L4DD033 997,00 €

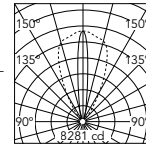

Beam Angle: 12°

h(m)	E(lx)	D(m)
1	8280	0.22
2	2070	0.44
3	920	0.66
4	517	0.87
5	331	1.09

@3000K

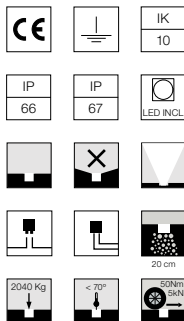
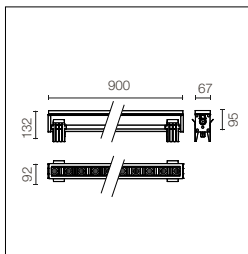

Source LED haute puissance incluse et optique en retrait équipée d'une grille à lamelles anti-éblouissement. Alimentation 220-240 V ON-OFF et variable 1-10 V et DALI. Le coffrage d'installation obligatoire doit être commandé séparément. Précâblé avec les connecteurs rapides H₂O Stop prise/fiche inclus. ACT (Anti Corrosion Treatment) sur demande.

High-power LED source included and rear lenses equipped with anti-glare diffuser grille. 1-10V or DALI on-off and dimmable 220-240V power supply. Compulsory installation box to be ordered separately. Pre-wired with H₂O Stop quick connectors, plug/socket included. ACT (Anti-Corrosion Treatment) upon request.

Optic Spot 16°

Power Led: 26W - LED 2795 lm ≠ OUTPUT 1505 lm - 2200K/CRI 80 / 26W - LED 2898 lm ≠ OUTPUT 1560 lm - 2700K/CRI 80 / 26W - LED 3105 lm ≠ OUTPUT 1672 lm - 3000K/CRI 80 / 26W - LED 3209 lm ≠ OUTPUT 1728 lm - 4000K/CRI 80

2200K	2700K	3000K	4000K	
Non Dimmable	Non Dimmable	Non Dimmable	Non Dimmable	
● F017L1HA006	● F017L2HA006	● F017L3HA006	● F017L4HA006	957,00 €
● F017L1JA033	● F017L2JA033	● F017L3JA033	● F017L4JA033	957,00 €
1-10V	1-10V	1-10V	1-10V	
● F017L1HB006	● F017L2HB006	● F017L3HB006	● F017L4HB006	994,00 €
● F017L1HB033	● F017L2HB033	● F017L3HB033	● F017L4HB033	994,00 €
Dali	Dali	Dali	Dali	
● F017L1HD006	● F017L2HD006	● F017L3HD006	● F017L4HD006	1.013,00 €
● F017L1HD033	● F017L2HD033	● F017L3HD033	● F017L4HD033	1.013,00 €

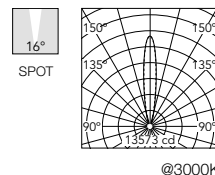

Optic Medium 25°

Power Led: 26W - LED 2795 lm ≠ OUTPUT 1594 lm - 2200K/CRI 80 / 26W - LED 2898 lm ≠ OUTPUT 1653 lm - 2700K/CRI 80 / 26W - LED 3105 lm ≠ OUTPUT 1771 lm - 3000K/CRI 80 / 26W - LED 3209 lm ≠ OUTPUT 1830 lm - 4000K/CRI 80

2200K	2700K	3000K	4000K	
Non Dimmable	Non Dimmable	Non Dimmable	Non Dimmable	
● F017L1JA006	● F017L2JA006	● F017L3JA006	● F017L4JA006	957,00 €
● F017L1JA033	● F017L2JA033	● F017L3JA033	● F017L4JA033	957,00 €
1-10V	1-10V	1-10V	1-10V	
● F017L1JB006	● F017L2JB006	● F017L3JB006	● F017L4JB006	994,00 €
● F017L1JB033	● F017L2JB033	● F017L3JB033	● F017L4JB033	994,00 €
Dali	Dali	Dali	Dali	
● F017L1JD006	● F017L2JD006	● F017L3JD006	● F017L4JD006	1.013,00 €
● F017L1JD033	● F017L2JD033	● F017L3JD033	● F017L4JD033	1.013,00 €

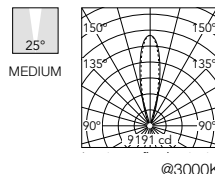

Optic Flood 39°

Power Led: 26W - LED 2795 lm ≠ OUTPUT 1233 lm - 2200K/CRI 80 / 26W - LED 2898 lm ≠ OUTPUT 1278 lm - 2700K/CRI 80 / 26W - LED 3105 lm ≠ OUTPUT 1370 lm - 3000K/CRI 80 / 26W - LED 3209 lm ≠ OUTPUT 1415 lm - 4000K/CRI 80

2200K	2700K	3000K	4000K	
Non Dimmable	Non Dimmable	Non Dimmable	Non Dimmable	
● F017L1KA006	● F017L2KA006	● F017L3KA006	● F017L4KA006	957,00 €
● F017L1KA033	● F017L2KA033	● F017L3KA033	● F017L4KA033	957,00 €
1-10V	1-10V	1-10V	1-10V	
● F017L1KB006	● F017L2KB006	● F017L3KB006	● F017L4KB006	994,00 €
● F017L1KB033	● F017L2KB033	● F017L3KB033	● F017L4KB033	994,00 €
Dali	Dali	Dali	Dali	
● F017L1KD006	● F017L2KD006	● F017L3KD006	● F017L4KD006	1.013,00 €
● F017L1KD033	● F017L2KD033	● F017L3KD033	● F017L4KD033	1.013,00 €

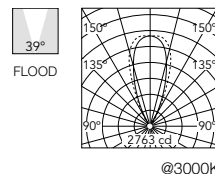

Optic Elliptical 13° x 40°

Power Led: 26W - LED 2795 lm ≠ OUTPUT 1229 lm - 2200K/CRI 80 / 26W - LED 2898 lm ≠ OUTPUT 1275 lm - 2700K/CRI 80 / 26W - LED 3105 lm ≠ OUTPUT 1366 lm - 3000K/CRI 80 / 26W - LED 3209 lm ≠ OUTPUT 1411 lm - 4000K/CRI 80

2200K	2700K	3000K	4000K	
Non Dimmable	Non Dimmable	Non Dimmable	Non Dimmable	
● F017L1LA006	● F017L2LA006	● F017L3LA006	● F017L4LA006	957,00 €
● F017L1LA033	● F017L2LA033	● F017L3LA033	● F017L4LA033	957,00 €
1-10V	1-10V	1-10V	1-10V	
● F017L1LB006	● F017L2LB006	● F017L3LB006	● F017L4LB006	994,00 €
● F017L1LB033	● F017L2LB033	● F017L3LB033	● F017L4LB033	994,00 €
Dali	Dali	Dali	Dali	
● F017L1LD006	● F017L2LD006	● F017L3LD006	● F017L4LD006	1.013,00 €
● F017L1LD033	● F017L2LD033	● F017L3LD033	● F017L4LD033	1.013,00 €

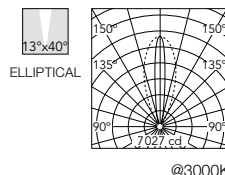

Ingraze Fixed Frameless + Asymmetric Louvre L 900

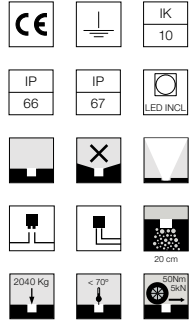
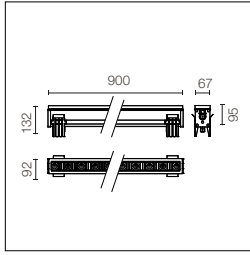

Source LED haute puissance incluse et optique en retrait équipée d'une grille à lamelles asymétrique anti-éblouissement. Alimentation 220-240 V ON-OFF et variable 1-10 V et DALI.
Le coffrage d'installation obligatoire doit être commandé séparément. Précâblé avec les connecteurs rapides H₂O Stop prise/fiche inclus. ACT (Anti Corrosion Treatment) sur demande.

High-power LED source included and rear lenses equipped with anti-glare asymmetrical diffuser grille. 1-10V or DALI on-off and dimmable 220-240V power supply. Compulsory installation box to be ordered separately. Pre-wired with H₂O Stop quick connectors, plug/socket included. ACT (Anti-Corrosion Treatment) upon request.

Optic Spot 15°

Power Led: 26W - LED 2795 lm ≠ OUTPUT 715 lm - 2200K/CRI 80 / 26W - LED 2898 lm ≠ OUTPUT 742 lm - 2700K/CRI 80 / 26W - LED 3105 lm ≠ OUTPUT 795 lm - 3000K/CRI 80 / 26W - LED 3209 lm ≠ OUTPUT 821 lm - 4000K/CRI 80

2200K	2700K	3000K	4000K		
Non Dimmable	Non Dimmable	Non Dimmable	Non Dimmable		
● F017L1QA006	● F017L2QA006	● F017L3QA006	● F017L4QA006	957,00 €	
● F017L1QA033	● F017L2QA033	● F017L3QA033	● F017L4QA033	957,00 €	
1-10V	1-10V	1-10V	1-10V		
● F017L1QB006	● F017L2QB006	● F017L3QB006	● F017L4QB006	994,00 €	
● F017L1QB033	● F017L2QB033	● F017L3QB033	● F017L4QB033	994,00 €	
Dali	Dali	Dali	Dali		
● F017L1QD006	● F017L2QD006	● F017L3QD006	● F017L4QD006	1.013,00 €	
● F017L1QD033	● F017L2QD033	● F017L3QD033	● F017L4QD033	1.013,00 €	

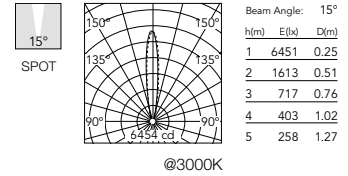

Optic Medium 25°

Power Led: 26W - LED 2795 lm ≠ OUTPUT 757 lm - 2200K/CRI 80 / 26W - LED 2898 lm ≠ OUTPUT 785 lm - 2700K/CRI 80 / 26W - LED 3105 lm ≠ OUTPUT 841 lm - 3000K/CRI 80 / 26W - LED 3209 lm ≠ OUTPUT 869 lm - 4000K/CRI 80

2200K	2700K	3000K	4000K		
Non Dimmable	Non Dimmable	Non Dimmable	Non Dimmable		
● F017L1RA006	● F017L2RA006	● F017L3RA006	● F017L4RA006	957,00 €	
● F017L1RA033	● F017L2RA033	● F017L3RA033	● F017L4RA033	957,00 €	
1-10V	1-10V	1-10V	1-10V		
● F017L1RB006	● F017L2RB006	● F017L3RB006	● F017L4RB006	994,00 €	
● F017L1RB033	● F017L2RB033	● F017L3RB033	● F017L4RB033	994,00 €	
Dali	Dali	Dali	Dali		
● F017L1RD006	● F017L2RD006	● F017L3RD006	● F017L4RD006	1.013,00 €	
● F017L1RD033	● F017L2RD033	● F017L3RD033	● F017L4RD033	1.013,00 €	

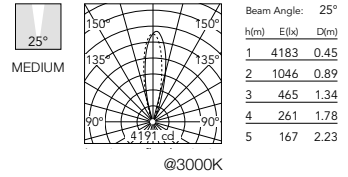

Optic Flood 42°

Power Led: 26W - LED 2795 lm ≠ OUTPUT 606 lm - 2200K/CRI 80 / 26W - LED 2898 lm ≠ OUTPUT 628 lm - 2700K/CRI 80 / 26W - LED 3105 lm ≠ OUTPUT 673 lm - 3000K/CRI 80 / 26W - LED 3209 lm ≠ OUTPUT 696 lm - 4000K/CRI 80

2200K	2700K	3000K	4000K		
Non Dimmable	Non Dimmable	Non Dimmable	Non Dimmable		
● F017L1SA006	● F017L2SA006	● F017L3SA006	● F017L4SA006	957,00 €	
● F017L1SA033	● F017L2SA033	● F017L3SA033	● F017L4SA033	957,00 €	
1-10V	1-10V	1-10V	1-10V		
● F017L1SB006	● F017L2SB006	● F017L3SB006	● F017L4SB006	994,00 €	
● F017L1SB033	● F017L2SB033	● F017L3SB033	● F017L4SB033	994,00 €	
Dali	Dali	Dali	Dali		
● F017L1SD006	● F017L2SD006	● F017L3SD006	● F017L4SD006	1.013,00 €	
● F017L1SD033	● F017L2SD033	● F017L3SD033	● F017L4SD033	1.013,00 €	

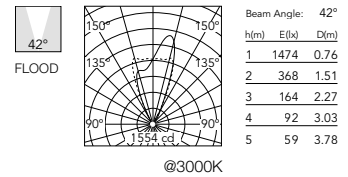

Optic Elliptical 12° x 40°

Power Led: 26W - LED 2795 lm ≠ OUTPUT 580 lm - 2200K/CRI 80 / 26W - LED 2898 lm ≠ OUTPUT 602 lm - 2700K/CRI 80 / 26W - LED 3105 lm ≠ OUTPUT 645 lm - 3000K/CRI 80 / 26W - LED 3209 lm ≠ OUTPUT 666 lm - 4000K/CRI 80

2200K	2700K	3000K	4000K		
Non Dimmable	Non Dimmable	Non Dimmable	Non Dimmable		
● F017L1TA006	● F017L2TA006	● F017L3TA006	● F017L4TA006	957,00 €	
● F017L1TA033	● F017L2TA033	● F017L3TA033	● F017L4TA033	957,00 €	
1-10V	1-10V	1-10V	1-10V		
● F017L1TB006	● F017L2TB006	● F017L3TB006	● F017L4TB006	994,00 €	
● F017L1TB033	● F017L2TB033	● F017L3TB033	● F017L4TB033	994,00 €	
Dali	Dali	Dali	Dali		
● F017L1TD006	● F017L2TD006	● F017L3TD006	● F017L4TD006	1.013,00 €	
● F017L1TD033	● F017L2TD033	● F017L3TD033	● F017L4TD033	1.013,00 €	

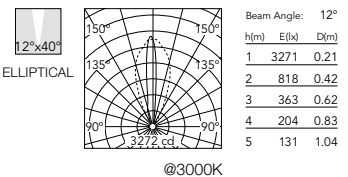

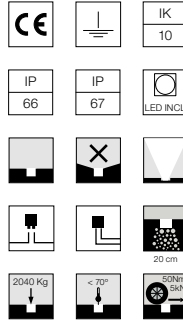
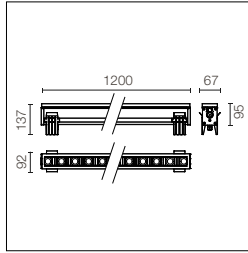

Source LED haute puissance incluse et optique en retrait.
Alimentation 220-240 V ON-OFF et variable 1-10 V et DALI.
Le coffrage d'installation obligatoire doit être commandé séparément.
Précâblé avec les connecteurs rapides H₂O Stop prise/fiche inclus.
ACT (Anti Corrosion Treatment) sur demande.

High-power LED source included and rear lenses. 1-10V or DALI on-off and dimmable 220-240V power supply.
Compulsory installation box to be ordered separately.
Pre-wired with H₂O Stop quick connectors, plug/socket included.
ACT (Anti-Corrosion Treatment) upon request.

Optic Spot 16°

Power Led: 33,5W - LED 3726 lm ≠ OUTPUT 2736 lm - 2200K/CRI 80 / 33,5W - LED 3864 lm ≠ OUTPUT 2837 lm - 2700K/CRI 80 / 33,5W - LED 4140 lm ≠ OUTPUT 3040 lm - 3000K/CRI 80 / 33,5W - LED 4278 lm ≠ OUTPUT 3141 lm - 4000K/CRI 80

2200K	2700K	3000K	4000K	
Non Dimmable	Non Dimmable	Non Dimmable	Non Dimmable	
● F017M1AA006	● F017M2AA006	● F017M3AA006	● F017M4AA006	1.066,00 €
● F017M1AA033	● F017M2AA033	● F017M3AA033	● F017M4AA033	1.066,00 €
1-10V	1-10V	1-10V	1-10V	
● F017M1AB006	● F017M2AB006	● F017M3AB006	● F017M4AB006	1.109,00 €
● F017M1AB033	● F017M2AB033	● F017M3AB033	● F017M4AB033	1.109,00 €
Dali	Dali	Dali	Dali	
● F017M1AD006	● F017M2AD006	● F017M3AD006	● F017M4AD006	1.124,00 €
● F017M1AD033	● F017M2AD033	● F017M3AD033	● F017M4AD033	1.124,00 €

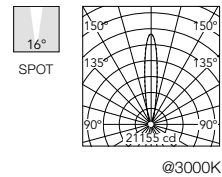

Beam Angle: 16°

h(m)	E(lx)	D(m)
1	21155	0.27
2	5289	0.55
3	2351	0.82
4	1322	1.09
5	846	1.37

Optic Medium 25°

Power Led: 33,5W - LED 3726 lm ≠ OUTPUT 2945 lm - 2200K/CRI 80 / 33,5W - LED 3864 lm ≠ OUTPUT 3054 lm - 2700K/CRI 80 / 33,5W - LED 4140 lm ≠ OUTPUT 3272 lm - 3000K/CRI 80 / 33,5W - LED 4278 lm ≠ OUTPUT 3381 lm - 4000K/CRI 80

2200K	2700K	3000K	4000K	
Non Dimmable	Non Dimmable	Non Dimmable	Non Dimmable	
● F017M1BA006	● F017M2BA006	● F017M3BA006	● F017M4BA006	1.066,00 €
● F017M1BA033	● F017M2BA033	● F017M3BA033	● F017M4BA033	1.066,00 €
1-10V	1-10V	1-10V	1-10V	
● F017M1BB006	● F017M2BB006	● F017M3BB006	● F017M4BB006	1.109,00 €
● F017M1BB033	● F017M2BB033	● F017M3BB033	● F017M4BB033	1.109,00 €
Dali	Dali	Dali	Dali	
● F017M1BD006	● F017M2BD006	● F017M3BD006	● F017M4BD006	1.124,00 €
● F017M1BD033	● F017M2BD033	● F017M3BD033	● F017M4BD033	1.124,00 €

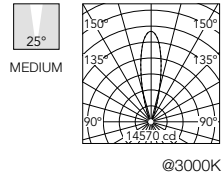

Beam Angle: 25°

h(m)	E(lx)	D(m)
1	14570	0.44
2	3643	0.88
3	1619	1.32
4	911	1.76
5	583	2.20

Optic Flood 46°

Power Led: 33,5W - LED 3726 lm ≠ OUTPUT 2565 lm - 2200K/CRI 80 / 33,5W - LED 3864 lm ≠ OUTPUT 2660 lm - 2700K/CRI 80 / 33,5W - LED 4140 lm ≠ OUTPUT 2850 lm - 3000K/CRI 80 / 33,5W - LED 4278 lm ≠ OUTPUT 2945 lm - 4000K/CRI 80

2200K	2700K	3000K	4000K	
Non Dimmable	Non Dimmable	Non Dimmable	Non Dimmable	
● F017M1CA006	● F017M2CA006	● F017M3CA006	● F017M4CA006	1.066,00 €
● F017M1CA033	● F017M2CA033	● F017M3CA033	● F017M4CA033	1.066,00 €
1-10V	1-10V	1-10V	1-10V	
● F017M1CB006	● F017M2CB006	● F017M3CB006	● F017M4CB006	1.109,00 €
● F017M1CB033	● F017M2CB033	● F017M3CB033	● F017M4CB033	1.109,00 €
Dali	Dali	Dali	Dali	
● F017M1CD006	● F017M2CD006	● F017M3CD006	● F017M4CD006	1.124,00 €
● F017M1CD033	● F017M2CD033	● F017M3CD033	● F017M4CD033	1.124,00 €

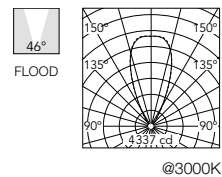

Beam Angle: 46°

h(m)	E(lx)	D(m)
1	4316	0.85
2	1079	1.71
3	480	2.56
4	270	3.42
5	173	4.27

Optic Elliptical 12° x 50°

Power Led: 33,5W - LED 3726 lm ≠ OUTPUT 2572 lm - 2200K/CRI 80 / 33,5W - LED 3864 lm ≠ OUTPUT 2668 lm - 2700K/CRI 80 / 33,5W - LED 4140 lm ≠ OUTPUT 2858 lm - 3000K/CRI 80 / 33,5W - LED 4278 lm ≠ OUTPUT 2953 lm - 4000K/CRI 80

2200K	2700K	3000K	4000K	
Non Dimmable	Non Dimmable	Non Dimmable	Non Dimmable	
● F017M1DA006	● F017M2DA006	● F017M3DA006	● F017M4DA006	1.066,00 €
● F017M1DA033	● F017M2DA033	● F017M3DA033	● F017M4DA033	1.066,00 €
1-10V	1-10V	1-10V	1-10V	
● F017M1DB006	● F017M2DB006	● F017M3DB006	● F017M4DB006	1.109,00 €
● F017M1DB033	● F017M2DB033	● F017M3DB033	● F017M4DB033	1.109,00 €
Dali	Dali	Dali	Dali	
● F017M1DD006	● F017M2DD006	● F017M3DD006	● F017M4DD006	1.124,00 €
● F017M1DD033	● F017M2DD033	● F017M3DD033	● F017M4DD033	1.124,00 €

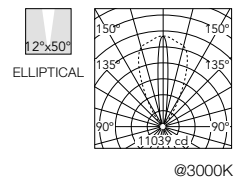

Beam Angle: 12°

h(m)	E(lx)	D(m)
1	11037	0.22
2	2759	0.44
3	1226	0.66
4	690	0.87
5	441	1.09

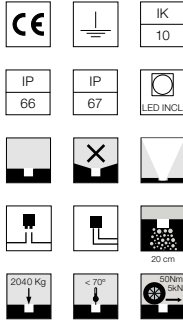
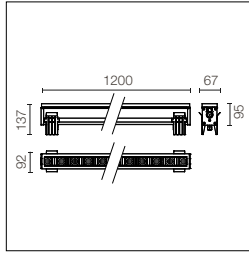

Source LED haute puissance incluse et optique en retrait équipée d'une grille à lamelles anti-éblouissement. Alimentation 220-240 V ON-OFF et variable 1-10 V et DALI. Le coffrage d'installation obligatoire doit être commandé séparément. Précâblé avec les connecteurs rapides H₂O Stop prise/fiche inclus. ACT (Anti Corrosion Treatment) sur demande.

High-power LED source included and rear lenses equipped with anti-glare diffuser grille. 1-10V or DALI on-off and dimmable 220-240V power supply. Compulsory installation box to be ordered separately. Pre-wired with H₂O Stop quick connectors, plug/socket included. ACT (Anti-Corrosion Treatment) upon request.

Optic Spot 16°

Power Led: 33,5W - LED 3726 lm ≠ OUTPUT 2006 lm - 2200K/CRI 80 / 33,5W - LED 3864 lm ≠ OUTPUT 2080 lm - 2700K/CRI 80 / 33,5W - LED 4140 lm ≠ OUTPUT 2229 lm - 3000K/CRI 80 / 33,5W - LED 4278 lm ≠ OUTPUT 2303 lm - 4000K/CRI 80

2200K	2700K	3000K	4000K	
Non Dimmable	Non Dimmable	Non Dimmable	Non Dimmable	
● F017M1HA006	● F017M2HA006	● F017M3HA006	● F017M4HA006	1.086,00 €
● F017M1HA033	● F017M2HA033	● F017M3HA033	● F017M4HA033	1.086,00 €
1-10V	1-10V	1-10V	1-10V	
● F017M1HB006	● F017M2HB006	● F017M3HB006	● F017M4HB006	1.129,00 €
● F017M1HB033	● F017M2HB033	● F017M3HB033	● F017M4HB033	1.129,00 €
Dali	Dali	Dali	Dali	
● F017M1HD006	● F017M2HD006	● F017M3HD006	● F017M4HD006	1.144,00 €
● F017M1HD033	● F017M2HD033	● F017M3HD033	● F017M4HD033	1.144,00 €

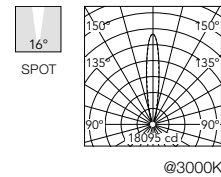

Optic Medium 25°

Power Led: 33,5W - LED 3726 lm ≠ OUTPUT 2125 lm - 2200K/CRI 80 / 33,5W - LED 3864 lm ≠ OUTPUT 2203 lm - 2700K/CRI 80 / 33,5W - LED 4140 lm ≠ OUTPUT 2361 lm - 3000K/CRI 80 / 33,5W - LED 4278 lm ≠ OUTPUT 2439 lm - 4000K/CRI 80

2200K	2700K	3000K	4000K	
Non Dimmable	Non Dimmable	Non Dimmable	Non Dimmable	
● F017M1JA006	● F017M2JA006	● F017M3JA006	● F017M4JA006	1.086,00 €
● F017M1JA033	● F017M2JA033	● F017M3JA033	● F017M4JA033	1.086,00 €
1-10V	1-10V	1-10V	1-10V	
● F017M1JB006	● F017M2JB006	● F017M3JB006	● F017M4JB006	1.129,00 €
● F017M1JB033	● F017M2JB033	● F017M3JB033	● F017M4JB033	1.129,00 €
Dali	Dali	Dali	Dali	
● F017M1JD006	● F017M2JD006	● F017M3JD006	● F017M4JD006	1.144,00 €
● F017M1JD033	● F017M2JD033	● F017M3JD033	● F017M4JD033	1.144,00 €

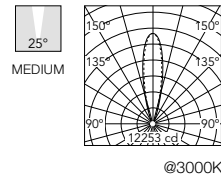

Optic Flood 39°

Power Led: 33,5W - LED 3726 lm ≠ OUTPUT 1643 lm - 2200K/CRI 80 / 33,5W - LED 3864 lm ≠ OUTPUT 1704 lm - 2700K/CRI 80 / 33,5W - LED 4140 lm ≠ OUTPUT 1826 lm - 3000K/CRI 80 / 33,5W - LED 4278 lm ≠ OUTPUT 1887 lm - 4000K/CRI 80

2200K	2700K	3000K	4000K	
Non Dimmable	Non Dimmable	Non Dimmable	Non Dimmable	
● F017M1KA006	● F017M2KA006	● F017M3KA006	● F017M4KA006	1.086,00 €
● F017M1KA033	● F017M2KA033	● F017M3KA033	● F017M4KA033	1.086,00 €
1-10V	1-10V	1-10V	1-10V	
● F017M1KB006	● F017M2KB006	● F017M3KB006	● F017M4KB006	1.129,00 €
● F017M1KB033	● F017M2KB033	● F017M3KB033	● F017M4KB033	1.129,00 €
Dali	Dali	Dali	Dali	
● F017M1KD006	● F017M2KD006	● F017M3KD006	● F017M4KD006	1.144,00 €
● F017M1KD033	● F017M2KD033	● F017M3KD033	● F017M4KD033	1.144,00 €

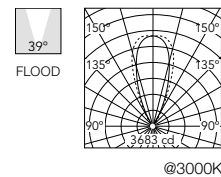

Optic Elliptical 13° x 40°

Power Led: 33,5W - LED 3726 lm ≠ OUTPUT 1639 lm - 2200K/CRI 80 / 33,5W - LED 3864 lm ≠ OUTPUT 1700 lm - 2700K/CRI 80 / 33,5W - LED 4140 lm ≠ OUTPUT 1821 lm - 3000K/CRI 80 / 33,5W - LED 4278 lm ≠ OUTPUT 1882 lm - 4000K/CRI 80

2200K	2700K	3000K	4000K	
Non Dimmable	Non Dimmable	Non Dimmable	Non Dimmable	
● F017M1LA006	● F017M2LA006	● F017M3LA006	● F017M4LA006	1.086,00 €
● F017M1LA033	● F017M2LA033	● F017M3LA033	● F017M4LA033	1.086,00 €
1-10V	1-10V	1-10V	1-10V	
● F017M1LB006	● F017M2LB006	● F017M3LB006	● F017M4LB006	1.129,00 €
● F017M1LB033	● F017M2LB033	● F017M3LB033	● F017M4LB033	1.129,00 €
Dali	Dali	Dali	Dali	
● F017M1LD006	● F017M2LD006	● F017M3LD006	● F017M4LD006	1.144,00 €
● F017M1LD033	● F017M2LD033	● F017M3LD033	● F017M4LD033	1.144,00 €

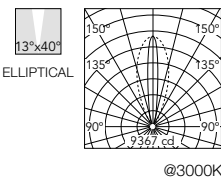

Ingraze Fixed Frameless + Asymmetric Louvre L 1200

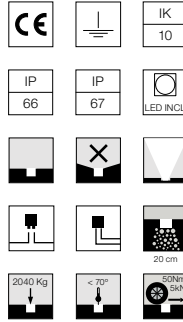
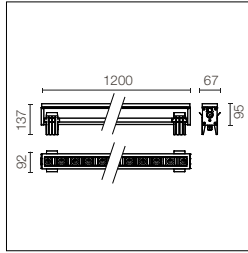

Source LED haute puissance incluse et optique en retrait équipée d'une grille à lamelles asymétrique anti-éblouissement. Alimentation 220-240 V ON-OFF et variable 1-10 V et DALI.
Le coffrage d'installation obligatoire doit être commandé séparément. Précâblé avec les connecteurs rapides H₂O Stop prise/fiche inclus. ACT (Anti Corrosion Treatment) sur demande.

High-power LED source included and rear lenses equipped with anti-glare asymmetrical diffuser grille. 1-10V or DALI on-off and dimmable 220-240V power supply. Compulsory installation box to be ordered separately. Pre-wired with H₂O Stop quick connectors, plug/socket included. ACT (Anti-Corrosion Treatment) upon request.

Optic Spot 15°

Power Led: 33,5W - LED 3726 lm ≠ OUTPUT 954 lm - 2200K/CRI 80 / 33,5W - LED 3864 lm ≠ OUTPUT 989 lm - 2700K/CRI 80 / 33,5W - LED 4140 lm ≠ OUTPUT 1059 lm - 3000K/CRI 80 / 33,5W - LED 4278 lm ≠ OUTPUT 1095 lm - 4000K/CRI 80

2200K	2700K	3000K	4000K		
Non Dimmable	Non Dimmable	Non Dimmable	Non Dimmable		
● F017M1QA006	● F017M2QA006	● F017M3QA006	● F017M4QA006	1.086,00 €	
● F017M1QA033	● F017M2QA033	● F017M3QA033	● F017M4QA033	1.086,00 €	
1-10V	1-10V	1-10V	1-10V		
● F017M1QB006	● F017M2QB006	● F017M3QB006	● F017M4QB006	1.129,00 €	
● F017M1QB033	● F017M2QB033	● F017M3QB033	● F017M4QB033	1.129,00 €	
Dali	Dali	Dali	Dali		
● F017M1QD006	● F017M2QD006	● F017M3QD006	● F017M4QD006	1.144,00 €	
● F017M1QD033	● F017M2QD033	● F017M3QD033	● F017M4QD033	1.144,00 €	

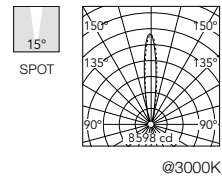

Beam Angle: 15°

h(m)	E(lx)	D(m)
1	8593	0.25
2	2148	0.51
3	955	0.76
4	537	1.02
5	344	1.27

@3000K

Optic Medium 25°

Power Led: 33,5W - LED 3726 lm ≠ OUTPUT 1009 lm - 2200K/CRI 80 / 33,5W - LED 3864 lm ≠ OUTPUT 1046 lm - 2700K/CRI 80 / 33,5W - LED 4140 lm ≠ OUTPUT 1121 lm - 3000K/CRI 80 / 33,5W - LED 4278 lm ≠ OUTPUT 1158 lm - 4000K/CRI 80

2200K	2700K	3000K	4000K		
Non Dimmable	Non Dimmable	Non Dimmable	Non Dimmable		
● F017M1RA006	● F017M2RA006	● F017M3RA006	● F017M4RA006	1.086,00 €	
● F017M1RA033	● F017M2RA033	● F017M3RA033	● F017M4RA033	1.086,00 €	
1-10V	1-10V	1-10V	1-10V		
● F017M1RB006	● F017M2RB006	● F017M3RB006	● F017M4RB006	1.129,00 €	
● F017M1RB033	● F017M2RB033	● F017M3RB033	● F017M4RB033	1.129,00 €	
Dali	Dali	Dali	Dali		
● F017M1RD006	● F017M2RD006	● F017M3RD006	● F017M4RD006	1.144,00 €	
● F017M1RD033	● F017M2RD033	● F017M3RD033	● F017M4RD033	1.144,00 €	

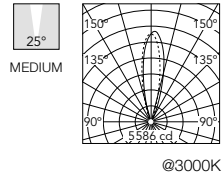

Beam Angle: 25°

h(m)	E(lx)	D(m)
1	5576	0.45
2	1394	0.89
3	620	1.34
4	349	1.78
5	223	2.23

@3000K

Optic Flood 42°

Power Led: 33,5W - LED 3726 lm ≠ OUTPUT 808 lm - 2200K/CRI 80 / 33,5W - LED 3864 lm ≠ OUTPUT 838 lm - 2700K/CRI 80 / 33,5W - LED 4140 lm ≠ OUTPUT 898 lm - 3000K/CRI 80 / 33,5W - LED 4278 lm ≠ OUTPUT 928 lm - 4000K/CRI 80

2200K	2700K	3000K	4000K		
Non Dimmable	Non Dimmable	Non Dimmable	Non Dimmable		
● F017M1SA006	● F017M2SA006	● F017M3SA006	● F017M4SA006	1.086,00 €	
● F017M1SA033	● F017M2SA033	● F017M3SA033	● F017M4SA033	1.086,00 €	
1-10V	1-10V	1-10V	1-10V		
● F017M1SB006	● F017M2SB006	● F017M3SB006	● F017M4SB006	1.129,00 €	
● F017M1SB033	● F017M2SB033	● F017M3SB033	● F017M4SB033	1.129,00 €	
Dali	Dali	Dali	Dali		
● F017M1SD006	● F017M2SD006	● F017M3SD006	● F017M4SD006	1.144,00 €	
● F017M1SD033	● F017M2SD033	● F017M3SD033	● F017M4SD033	1.144,00 €	

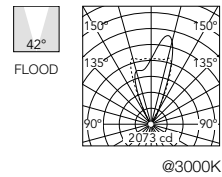

Beam Angle: 42°

h(m)	E(lx)	D(m)
1	1967	0.76
2	492	1.51
3	219	2.27
4	123	3.03
5	79	3.78

@3000K

Optic Elliptical 12° x 40°

Power Led: 33,5W - LED 3726 lm ≠ OUTPUT 773 lm - 2200K/CRI 80 / 33,5W - LED 3864 lm ≠ OUTPUT 802 lm - 2700K/CRI 80 / 33,5W - LED 4140 lm ≠ OUTPUT 859 lm - 3000K/CRI 80 / 33,5W - LED 4278 lm ≠ OUTPUT 888 lm - 4000K/CRI 80

2200K	2700K	3000K	4000K		
Non Dimmable	Non Dimmable	Non Dimmable	Non Dimmable		
● F017M1TA006	● F017M2TA006	● F017M3TA006	● F017M4TA006	1.086,00 €	
● F017M1TA033	● F017M2TA033	● F017M3TA033	● F017M4TA033	1.086,00 €	
1-10V	1-10V	1-10V	1-10V		
● F017M1TB006	● F017M2TB006	● F017M3TB006	● F017M4TB006	1.129,00 €	
● F017M1TB033	● F017M2TB033	● F017M3TB033	● F017M4TB033	1.129,00 €	
Dali	Dali	Dali	Dali		
● F017M1TD006	● F017M2TD006	● F017M3TD006	● F017M4TD006	1.144,00 €	
● F017M1TD033	● F017M2TD033	● F017M3TD033	● F017M4TD033	1.144,00 €	

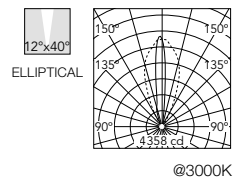

Beam Angle: 12°

h(m)	E(lx)	D(m)
1	4356	0.21
2	1089	0.42
3	484	0.62
4	272	0.83
5	174	1.04

@3000K

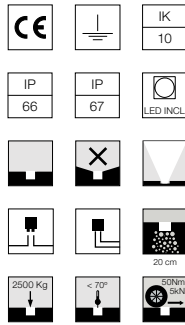
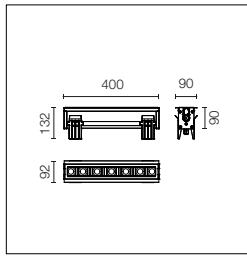

Source LED haute puissance incluse et optique en retrait.
Alimentation 220-240 V ON-OFF et variable 1-10 V et DALI.
Le coffrage d'installation obligatoire doit être commandé séparément.
Précâblé avec les connecteurs rapides H₂O Stop prise/fiche inclus.
ACT (Anti Corrosion Treatment) sur demande.

High-power LED source included and rear lenses. 1-10V or DALI on-off and dimmable 220-240V power supply.
Compulsory installation box to be ordered separately.
Pre-wired with H₂O Stop quick connectors, plug/socket included.
ACT (Anti-Corrosion Treatment) upon request.

Optic Spot 16°

Power Led: 12,5W - LED 1304 lm ≠ OUTPUT 958 lm - 2200K/CRI 80 / 12,5W - LED 1352 lm ≠ OUTPUT 993 lm - 2700K/CRI 80 / 12,5W - LED 1449 lm ≠ OUTPUT 1064 lm - 3000K/CRI 80 / 12,5W - LED 1497 lm ≠ OUTPUT 1100 lm - 4000K/CRI 80

2200K	2700K	3000K	4000K	
Non Dimmable	Non Dimmable	Non Dimmable	Non Dimmable	
● F017E1AA006	● F017E2AA006	● F017E3AA006	● F017E4AA006	657,00 €
● F017E1AA033	● F017E2AA033	● F017E3AA033	● F017E4AA033	657,00 €
1-10V	1-10V	1-10V	1-10V	
● F017E1AB006	● F017E2AB006	● F017E3AB006	● F017E4AB006	683,00 €
● F017E1AB033	● F017E2AB033	● F017E3AB033	● F017E4AB033	683,00 €
Dali	Dali	Dali	Dali	
● F017E1AD006	● F017E2AD006	● F017E3AD006	● F017E4AD006	701,00 €
● F017E1AD033	● F017E2AD033	● F017E3AD033	● F017E4AD033	701,00 €

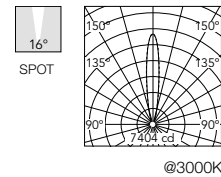

Optic Medium 25°

Power Led: 12,5W - LED 1304 lm ≠ OUTPUT 1031 lm - 2200K/CRI 80 / 12,5W - LED 1352 lm ≠ OUTPUT 1069 lm - 2700K/CRI 80 / 12,5W - LED 1449 lm ≠ OUTPUT 1146 lm - 3000K/CRI 80 / 12,5W - LED 1497 lm ≠ OUTPUT 1184 lm - 4000K/CRI 80

2200K	2700K	3000K	4000K	
Non Dimmable	Non Dimmable	Non Dimmable	Non Dimmable	
● F017E1BA006	● F017E2BA006	● F017E3BA006	● F017E4BA006	657,00 €
● F017E1BA033	● F017E2BA033	● F017E3BA033	● F017E4BA033	657,00 €
1-10V	1-10V	1-10V	1-10V	
● F017E1BB006	● F017E2BB006	● F017E3BB006	● F017E4BB006	683,00 €
● F017E1BB033	● F017E2BB033	● F017E3BB033	● F017E4BB033	683,00 €
Dali	Dali	Dali	Dali	
● F017E1BD006	● F017E2BD006	● F017E3BD006	● F017E4BD006	701,00 €
● F017E1BD033	● F017E2BD033	● F017E3BD033	● F017E4BD033	701,00 €

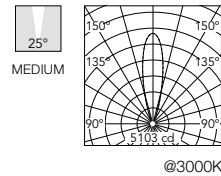

Optic Flood 46°

Power Led: 12,5W - LED 1304 lm ≠ OUTPUT 898 lm - 2200K/CRI 80 / 12,5W - LED 1352 lm ≠ OUTPUT 931 lm - 2700K/CRI 80 / 12,5W - LED 1449 lm ≠ OUTPUT 998 lm - 3000K/CRI 80 / 12,5W - LED 1497 lm ≠ OUTPUT 1031 lm - 4000K/CRI 80

2200K	2700K	3000K	4000K	
Non Dimmable	Non Dimmable	Non Dimmable	Non Dimmable	
● F017E1CA006	● F017E2CA006	● F017E3CA006	● F017E4CA006	657,00 €
● F017E1CA033	● F017E2CA033	● F017E3CA033	● F017E4CA033	657,00 €
1-10V	1-10V	1-10V	1-10V	
● F017E1CB006	● F017E2CB006	● F017E3CB006	● F017E4CB006	683,00 €
● F017E1CB033	● F017E2CB033	● F017E3CB033	● F017E4CB033	683,00 €
Dali	Dali	Dali	Dali	
● F017E1CD006	● F017E2CD006	● F017E3CD006	● F017E4CD006	701,00 €
● F017E1CD033	● F017E2CD033	● F017E3CD033	● F017E4CD033	701,00 €

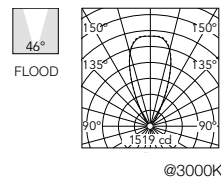

Optic Elliptical 12° x 50°

Power Led: 12,5W - LED 1304 lm ≠ OUTPUT 901 lm - 2200K/CRI 80 / 12,5W - LED 1352 lm ≠ OUTPUT 934 lm - 2700K/CRI 80 / 12,5W - LED 1449 lm ≠ OUTPUT 1001 lm - 3000K/CRI 80 / 12,5W - LED 1497 lm ≠ OUTPUT 1034 lm - 4000K/CRI 80

2200K	2700K	3000K	4000K	
Non Dimmable	Non Dimmable	Non Dimmable	Non Dimmable	
● F017E1DA006	● F017E2DA006	● F017E3DA006	● F017E4DA006	657,00 €
● F017E1DA033	● F017E2DA033	● F017E3DA033	● F017E4DA033	657,00 €
1-10V	1-10V	1-10V	1-10V	
● F017E1DB006	● F017E2DB006	● F017E3DB006	● F017E4DB006	683,00 €
● F017E1DB033	● F017E2DB033	● F017E3DB033	● F017E4DB033	683,00 €
Dali	Dali	Dali	Dali	
● F017E1DD006	● F017E2DD006	● F017E3DD006	● F017E4DD006	701,00 €
● F017E1DD033	● F017E2DD033	● F017E3DD033	● F017E4DD033	701,00 €

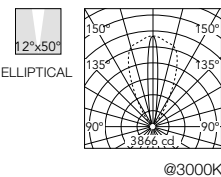

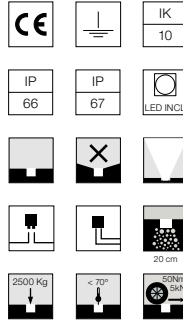
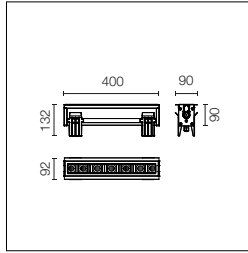

Source LED haute puissance incluse et optique en retrait équipée d'une grille à lamelles anti-éblouissement. Alimentation 220-240 V ON-OFF et variable 1-10 V et DALI. Le coffrage d'installation obligatoire doit être commandé séparément. Précâblé avec les connecteurs rapides H₂O Stop prise/fiche inclus. ACT (Anti Corrosion Treatment) sur demande.

High-power LED source included and rear lenses equipped with anti-glare diffuser grille. 1-10V or DALI on-off and dimmable 220-240V power supply. Compulsory installation box to be ordered separately. Pre-wired with H₂O Stop quick connectors, plug/socket included. ACT (Anti-Corrosion Treatment) upon request.

Optic Spot 16°

Power Led: 12,5W - LED 1304 lm ≠ OUTPUT 702 lm - 2200K/CRI 80 / 12,5W - LED 1352 lm ≠ OUTPUT 728 lm - 2700K/CRI 80 / 12,5W - LED 1449 lm ≠ OUTPUT 780 lm - 3000K/CRI 80 / 12,5W - LED 1497 lm ≠ OUTPUT 806 lm - 4000K/CRI 80

2200K	2700K	3000K	4000K	
Non Dimmable	Non Dimmable	Non Dimmable	Non Dimmable	
● F017E1HA006	● F017E2HA006	● F017E3HA006	● F017E4HA006	664,00 €
● F017E1HA033	● F017E2HA033	● F017E3HA033	● F017E4HA033	664,00 €
1-10V	1-10V	1-10V	1-10V	
● F017E1HB006	● F017E2HB006	● F017E3HB006	● F017E4HB006	690,00 €
● F017E1HB033	● F017E2HB033	● F017E3HB033	● F017E4HB033	690,00 €
Dali	Dali	Dali	Dali	
● F017E1HD006	● F017E2HD006	● F017E3HD006	● F017E4HD006	708,00 €
● F017E1HD033	● F017E2HD033	● F017E3HD033	● F017E4HD033	708,00 €

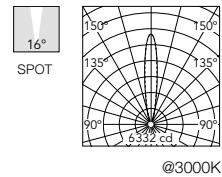

Beam Angle: 16°

h(m)	E(lx)	D(m)
1	6332	0.28
2	1583	0.56
3	704	0.83
4	396	1.11
5	253	1.39

@3000K

Optic Medium 25°

Power Led: 12,5W - LED 1304 lm ≠ OUTPUT 744 lm - 2200K/CRI 80 / 12,5W - LED 1352 lm ≠ OUTPUT 772 lm - 2700K/CRI 80 / 12,5W - LED 1449 lm ≠ OUTPUT 827 lm - 3000K/CRI 80 / 12,5W - LED 1497 lm ≠ OUTPUT 854 lm - 4000K/CRI 80

2200K	2700K	3000K	4000K	
Non Dimmable	Non Dimmable	Non Dimmable	Non Dimmable	
● F017E1JA006	● F017E2JA006	● F017E3JA006	● F017E4JA006	664,00 €
● F017E1JA033	● F017E2JA033	● F017E3JA033	● F017E4JA033	664,00 €
1-10V	1-10V	1-10V	1-10V	
● F017E1JB006	● F017E2JB006	● F017E3JB006	● F017E4JB006	690,00 €
● F017E1JB033	● F017E2JB033	● F017E3JB033	● F017E4JB033	690,00 €
Dali	Dali	Dali	Dali	
● F017E1JD006	● F017E2JD006	● F017E3JD006	● F017E4JD006	708,00 €
● F017E1JD033	● F017E2JD033	● F017E3JD033	● F017E4JD033	708,00 €

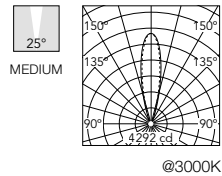

Beam Angle: 25°

h(m)	E(lx)	D(m)
1	4292	0.44
2	1073	0.87
3	477	1.31
4	268	1.74
5	172	2.18

@3000K

Optic Flood 39°

Power Led: 12,5W - LED 1304 lm ≠ OUTPUT 576 lm - 2200K/CRI 80 / 12,5W - LED 1352 lm ≠ OUTPUT 597 lm - 2700K/CRI 80 / 12,5W - LED 1449 lm ≠ OUTPUT 639 lm - 3000K/CRI 80 / 12,5W - LED 1497 lm ≠ OUTPUT 661 lm - 4000K/CRI 80

2200K	2700K	3000K	4000K	
Non Dimmable	Non Dimmable	Non Dimmable	Non Dimmable	
● F017E1KA006	● F017E2KA006	● F017E3KA006	● F017E4KA006	664,00 €
● F017E1KA033	● F017E2KA033	● F017E3KA033	● F017E4KA033	664,00 €
1-10V	1-10V	1-10V	1-10V	
● F017E1KB006	● F017E2KB006	● F017E3KB006	● F017E4KB006	690,00 €
● F017E1KB033	● F017E2KB033	● F017E3KB033	● F017E4KB033	690,00 €
Dali	Dali	Dali	Dali	
● F017E1KD006	● F017E2KD006	● F017E3KD006	● F017E4KD006	708,00 €
● F017E1KD033	● F017E2KD033	● F017E3KD033	● F017E4KD033	708,00 €

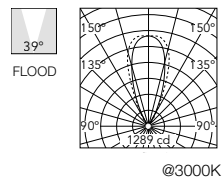

Beam Angle: 39°

h(m)	E(lx)	D(m)
1	1285	0.71
2	321	1.43
3	143	2.14
4	80	2.86
5	51	3.57

@3000K

Optic Elliptical 13° x 40°

Power Led: 12,5W - LED 1304 lm ≠ OUTPUT 574 lm - 2200K/CRI 80 / 12,5W - LED 1352 lm ≠ OUTPUT 595 lm - 2700K/CRI 80 / 12,5W - LED 1449 lm ≠ OUTPUT 638 lm - 3000K/CRI 80 / 12,5W - LED 1497 lm ≠ OUTPUT 659 lm - 4000K/CRI 80

2200K	2700K	3000K	4000K	
Non Dimmable	Non Dimmable	Non Dimmable	Non Dimmable	
● F017E1LA006	● F017E2LA006	● F017E3LA006	● F017E4LA006	664,00 €
● F017E1LA033	● F017E2LA033	● F017E3LA033	● F017E4LA033	664,00 €
1-10V	1-10V	1-10V	1-10V	
● F017E1LB006	● F017E2LB006	● F017E3LB006	● F017E4LB006	690,00 €
● F017E1LB033	● F017E2LB033	● F017E3LB033	● F017E4LB033	690,00 €
Dali	Dali	Dali	Dali	
● F017E1LD006	● F017E2LD006	● F017E3LD006	● F017E4LD006	708,00 €
● F017E1LD033	● F017E2LD033	● F017E3LD033	● F017E4LD033	708,00 €

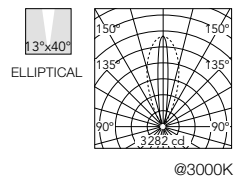

Beam Angle: 13°

h(m)	E(lx)	D(m)
1	3282	0.22
2	820	0.44
3	365	0.67
4	205	0.89
5	131	1.11

@3000K

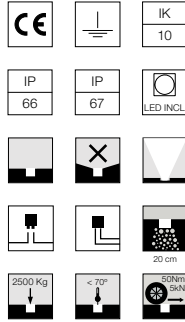
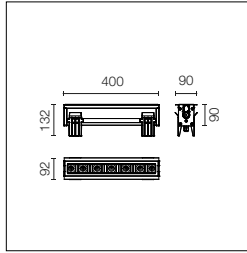

Source LED haute puissance incluse et optique en retrait équipée d'une grille à lamelles asymétrique anti-éblouissement. Alimentation 220-240 V ON-OFF et variable 1-10 V et DALI.
Le coffrage d'installation obligatoire doit être commandé séparément. Précâblé avec les connecteurs rapides H₂O Stop prise/fiche inclus. ACT (Anti Corrosion Treatment) sur demande.

High-power LED source included and rear lenses equipped with anti-glare asymmetrical diffuser grille. 1-10V or DALI on-off and dimmable 220-240V power supply. Compulsory installation box to be ordered separately. Pre-wired with H₂O Stop quick connectors, plug/socket included. ACT (Anti-Corrosion Treatment) upon request.

Optic Spot 15°

Power Led: 12,5W - LED 1304 lm ≠ OUTPUT 334 lm - 2200K/CRI 80 / 12,5W - LED 1352 lm ≠ OUTPUT 346 lm - 2700K/CRI 80 / 12,5W - LED 1449 lm ≠ OUTPUT 371 lm - 3000K/CRI 80 / 12,5W - LED 1497 lm ≠ OUTPUT 383 lm - 4000K/CRI 80

2200K

Non Dimmable

- F017E1QA006
- F017E1QA033
- 1-10V
- F017E1QB006
- F017E1QB033
- Dali
- F017E1QD006
- F017E1QD033

2700K

Non Dimmable

- F017E2QA006
- F017E2QA033
- 1-10V
- F017E2QB006
- F017E2QB033
- Dali
- F017E2QD006
- F017E2QD033

3000K

Non Dimmable

- F017E3QA006
- F017E3QA033
- 1-10V
- F017E3QB006
- F017E3QB033
- Dali
- F017E3QD006
- F017E3QD033

4000K

Non Dimmable

- F017E4QA006 664,00 €
- F017E4QA033 664,00 €
- 1-10V
- F017E4QB006 690,00 €
- F017E4QB033 690,00 €
- Dali
- F017E4QD006 708,00 €
- F017E4QD033 708,00 €

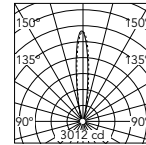

Beam Angle: 15°

h(m)	E(lx)	D(m)
1	3010	0.25
2	753	0.51
3	334	0.76
4	188	1.02
5	120	1.27

@3000K

Optic Medium 25°

Power Led: 12,5W - LED 1304 lm ≠ OUTPUT 353 lm - 2200K/CRI 80 / 12,5W - LED 1352 lm ≠ OUTPUT 367 lm - 2700K/CRI 80 / 12,5W - LED 1449 lm ≠ OUTPUT 393 lm - 3000K/CRI 80 / 12,5W - LED 1497 lm ≠ OUTPUT 406 lm - 4000K/CRI 80

2200K

Non Dimmable

- F017E1RA006
- F017E1RA033
- 1-10V
- F017E1RB006
- F017E1RB033
- Dali
- F017E1RD006
- F017E1RD033

2700K

Non Dimmable

- F017E2RA006
- F017E2RA033
- 1-10V
- F017E2RB006
- F017E2RB033
- Dali
- F017E2RD006
- F017E2RD033

3000K

Non Dimmable

- F017E3RA006
- F017E3RA033
- 1-10V
- F017E3RB006
- F017E3RB033
- Dali
- F017E3RD006
- F017E3RD033

4000K

Non Dimmable

- F017E4RA006 664,00 €
- F017E4RA033 664,00 €
- 1-10V
- F017E4RB006 690,00 €
- F017E4RB033 690,00 €
- Dali
- F017E4RD006 708,00 €
- F017E4RD033 708,00 €

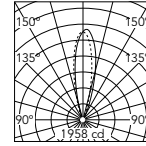

Beam Angle: 25°

h(m)	E(lx)	D(m)
1	1955	0.45
2	489	0.89
3	217	1.34
4	122	1.78
5	78	2.23

@3000K

Optic Flood 42°

Power Led: 12,5W - LED 1304 lm ≠ OUTPUT 620 lm - 2200K/CRI 80 / 12,5W - LED 1352 lm ≠ OUTPUT 294 lm - 2700K/CRI 80 / 12,5W - LED 1449 lm ≠ OUTPUT 314 lm - 3000K/CRI 80 / 12,5W - LED 1497 lm ≠ OUTPUT 325 lm - 4000K/CRI 80

2200K

Non Dimmable

- F017E1SA006
- F017E1SA033
- 1-10V
- F017E1SB006
- F017E1SB033
- Dali
- F017E1SD006
- F017E1SD033

2700K

Non Dimmable

- F017E2SA006
- F017E2SA033
- 1-10V
- F017E2SB006
- F017E2SB033
- Dali
- F017E2SD006
- F017E2SD033

3000K

Non Dimmable

- F017E3SA006
- F017E3SA033
- 1-10V
- F017E3SB006
- F017E3SB033
- Dali
- F017E3SD006
- F017E3SD033

4000K

Non Dimmable

- F017E4SA006 664,00 €
- F017E4SA033 664,00 €
- 1-10V
- F017E4SB006 690,00 €
- F017E4SB033 690,00 €
- Dali
- F017E4SD006 708,00 €
- F017E4SD033 708,00 €

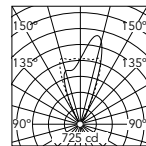

Beam Angle: 42°

h(m)	E(lx)	D(m)
1	688	0.76
2	172	1.51
3	76	2.27
4	43	3.03
5	28	3.78

@3000K

Optic Elliptical 12° x 40°

Power Led: 12,5W - LED 1304 lm ≠ OUTPUT 271 lm - 2200K/CRI 80 / 12,5W - LED 1352 lm ≠ OUTPUT 281 lm - 2700K/CRI 80 / 12,5W - LED 1449 lm ≠ OUTPUT 301 lm - 3000K/CRI 80 / 12,5W - LED 1497 lm ≠ OUTPUT 311 lm - 4000K/CRI 80

2200K

Non Dimmable

- F017E1TA006
- F017E1TA033
- 1-10V
- F017E1TB006
- F017E1TB033
- Dali
- F017E1TD006
- F017E1TD033

2700K

Non Dimmable

- F017E2TA006
- F017E2TA033
- 1-10V
- F017E2TB006
- F017E2TB033
- Dali
- F017E2TD006
- F017E2TD033

3000K

Non Dimmable

- F017E3TA006
- F017E3TA033
- 1-10V
- F017E3TB006
- F017E3TB033
- Dali
- F017E3TD006
- F017E3TD033

4000K

Non Dimmable

- F017E4TA006 664,00 €
- F017E4TA033 664,00 €
- 1-10V
- F017E4TB006 690,00 €
- F017E4TB033 690,00 €
- Dali
- F017E4TD006 708,00 €
- F017E4TD033 708,00 €

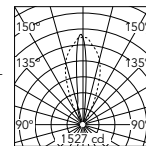

Beam Angle: 12°

h(m)	E(lx)	Dx(m)
1	1526	0.21
2	382	0.42
3	170	0.62
4	95	0.83
5	61	1.04

@3000K

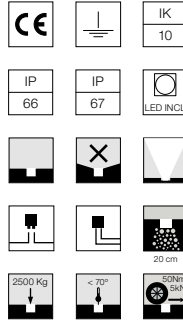
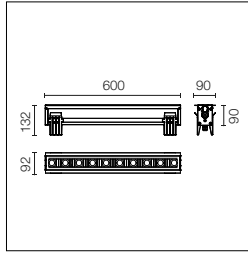

Source LED haute puissance incluse et optique en retrait.
Alimentation 220-240 V ON-OFF et variable 1-10 V et DALI.
Le coffrage d'installation obligatoire doit être commandé séparément.
Précâblé avec les connecteurs rapides H₂O Stop prise/fiche inclus.
ACT (Anti Corrosion Treatment) sur demande.

High-power LED source included and rear lenses. 1-10V or DALI on-off and dimmable 220-240V power supply.
Compulsory installation box to be ordered separately.
Pre-wired with H₂O Stop quick connectors, plug/socket included.
ACT (Anti-Corrosion Treatment) upon request.

Optic Spot 16°

Power Led: 17W - LED 1863 lm ≠ OUTPUT 1368 lm - 2200K/CRI 80 / 17W - LED 1932 lm ≠ OUTPUT 1419 lm - 2700K/CRI 80 / 17W - LED 2070 lm ≠ OUTPUT 1520 lm - 3000K/CRI 80 / 17W - LED 2139 lm ≠ OUTPUT 1571 lm - 4000K/CRI 80

2200K	2700K	3000K	4000K	
Non Dimmable	Non Dimmable	Non Dimmable	Non Dimmable	
● F017F1AA006	● F017F2AA006	● F017F3AA006	● F017F4AA006	847,00 €
● F017F1AA033	● F017F2AA033	● F017F3AA033	● F017F4AA033	847,00 €
1-10V	1-10V	1-10V	1-10V	
● F017F1AB006	● F017F2AB006	● F017F3AB006	● F017F4AB006	881,00 €
● F017F1AB033	● F017F2AB033	● F017F3AB033	● F017F4AB033	881,00 €
Dali	Dali	Dali	Dali	
● F017F1AD006	● F017F2AD006	● F017F3AD006	● F017F4AD006	903,00 €
● F017F1AD033	● F017F2AD033	● F017F3AD033	● F017F4AD033	903,00 €

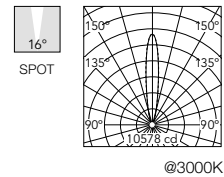

Optic Medium 25°

Power Led: 17W - LED 1863 lm ≠ OUTPUT 1473 lm - 2200K/CRI 80 / 17W - LED 1932 lm ≠ OUTPUT 1527 lm - 2700K/CRI 80 / 17W - LED 2070 lm ≠ OUTPUT 1636 lm - 3000K/CRI 80 / 17W - LED 2139 lm ≠ OUTPUT 1691 lm - 4000K/CRI 80

2200K	2700K	3000K	4000K	
Non Dimmable	Non Dimmable	Non Dimmable	Non Dimmable	
● F017F1BA006	● F017F2BA006	● F017F3BA006	● F017F4BA006	847,00 €
● F017F1BA033	● F017F2BA033	● F017F3BA033	● F017F4BA033	847,00 €
1-10V	1-10V	1-10V	1-10V	
● F017F1BB006	● F017F2BB006	● F017F3BB006	● F017F4BB006	881,00 €
● F017F1BB033	● F017F2BB033	● F017F3BB033	● F017F4BB033	881,00 €
Dali	Dali	Dali	Dali	
● F017F1BD006	● F017F2BD006	● F017F3BD006	● F017F4BD006	903,00 €
● F017F1BD033	● F017F2BD033	● F017F3BD033	● F017F4BD033	903,00 €

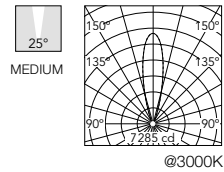

Optic Flood 46°

Power Led: 17W - LED 1863 lm ≠ OUTPUT 1283 lm - 2200K/CRI 80 / 17W - LED 1932 lm ≠ OUTPUT 1330 lm - 2700K/CRI 80 / 17W - LED 2070 lm ≠ OUTPUT 1425 lm - 3000K/CRI 80 / 17W - LED 2139 lm ≠ OUTPUT 1473 lm - 4000K/CRI 80

2200K	2700K	3000K	4000K	
Non Dimmable	Non Dimmable	Non Dimmable	Non Dimmable	
● F017F1CA006	● F017F2CA006	● F017F3CA006	● F017F4CA006	847,00 €
● F017F1CA033	● F017F2CA033	● F017F3CA033	● F017F4CA033	847,00 €
1-10V	1-10V	1-10V	1-10V	
● F017F1CB006	● F017F2CB006	● F017F3CB006	● F017F4CB006	881,00 €
● F017F1CB033	● F017F2CB033	● F017F3CB033	● F017F4CB033	881,00 €
Dali	Dali	Dali	Dali	
● F017F1CD006	● F017F2CD006	● F017F3CD006	● F017F4CD006	903,00 €
● F017F1CD033	● F017F2CD033	● F017F3CD033	● F017F4CD033	903,00 €

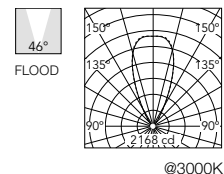

Optic Elliptical 12° x 50°

Power Led: 17W - LED 1863 lm ≠ OUTPUT 1286 lm - 2200K/CRI 80 / 17W - LED 1932 lm ≠ OUTPUT 1334 lm - 2700K/CRI 80 / 17W - LED 2070 lm ≠ OUTPUT 1429 lm - 3000K/CRI 80 / 17W - LED 2139 lm ≠ OUTPUT 1477 lm - 4000K/CRI 80

2200K	2700K	3000K	4000K	
Non Dimmable	Non Dimmable	Non Dimmable	Non Dimmable	
● F017F1DA006	● F017F2DA006	● F017F3DA006	● F017F4DA006	847,00 €
● F017F1DA033	● F017F2DA033	● F017F3DA033	● F017F4DA033	847,00 €
1-10V	1-10V	1-10V	1-10V	
● F017F1DB006	● F017F2DB006	● F017F3DB006	● F017F4DB006	881,00 €
● F017F1DB033	● F017F2DB033	● F017F3DB033	● F017F4DB033	881,00 €
Dali	Dali	Dali	Dali	
● F017F1DD006	● F017F2DD006	● F017F3DD006	● F017F4DD006	903,00 €
● F017F1DD033	● F017F2DD033	● F017F3DD033	● F017F4DD033	903,00 €

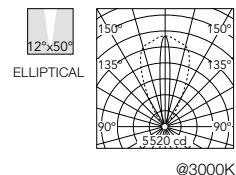

Ingraze Adjustable Frame + Linear Louvre L 600

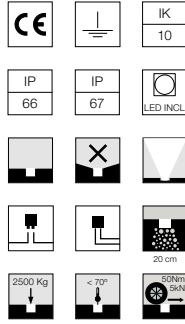
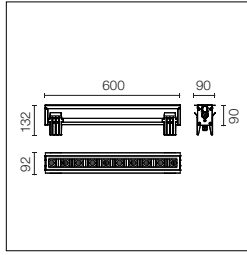

Source LED haute puissance incluse et optique en retrait équipée d'une grille à lamelles anti-éblouissement. Alimentation 220-240 V ON-OFF et variable 1-10 V et DALI.
Le coffrage d'installation obligatoire doit être commandé séparément. Précâblé avec les connecteurs rapides H₂O Stop prise/fiche inclus. ACT (Anti Corrosion Treatment) sur demande.

High-power LED source included and rear lenses equipped with anti-glare diffuser grille. 1-10V or DALI on-off and dimmable 220-240V power supply. Compulsory installation box to be ordered separately. Pre-wired with H₂O Stop quick connectors, plug/socket included. ACT (Anti-Corrosion Treatment) upon request.

Optic Spot 16°

Power Led: 17W - LED 1863 lm ≠ OUTPUT 1003 lm - 2200K/CRI 80 / 17W - LED 1932 lm ≠ OUTPUT 1040 lm - 2700K/CRI 80 / 17W - LED 2070 lm ≠ OUTPUT 1115 lm - 3000K/CRI 80 / 17W - LED 2139 lm ≠ OUTPUT 1152 lm - 4000K/CRI 80

2200K

Non Dimmable

- F017F1HA006
- F017F1HA033
- 1-10V
- F017F1HB006
- F017F1HB033
- Dali
- F017F1HD006
- F017F1HD033

2700K

Non Dimmable

- F017F2HA006
- F017F2HA033
- 1-10V
- F017F2HB006
- F017F2HB033
- Dali
- F017F2HD006
- F017F2HD033

3000K

Non Dimmable

- F017F3HA006
- F017F3HA033
- 1-10V
- F017F3HB006
- F017F3HB033
- Dali
- F017F3HD006
- F017F3HD033

4000K

Non Dimmable

- F017F4HA006 857,00 €
- F017F4HA033 857,00 €
- 1-10V
- F017F4HB006 891,00 €
- F017F4HB033 891,00 €
- Dali
- F017F4HD006 913,00 €
- F017F4HD033 913,00 €

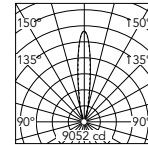

Beam Angle: 16°

h(m)	E(lx)	D(m)
1	9052	0.28
2	2263	0.56
3	1006	0.83
4	566	1.11
5	362	1.39

@3000K

Optic Medium 25°

Power Led: 17W - LED 1863 lm ≠ OUTPUT 1063 lm - 2200K/CRI 80 / 17W - LED 1932 lm ≠ OUTPUT 1102 lm - 2700K/CRI 80 / 17W - LED 2070 lm ≠ OUTPUT 1181 lm - 3000K/CRI 80 / 17W - LED 2139 lm ≠ OUTPUT 1220 lm - 4000K/CRI 80

2200K

Non Dimmable

- F017F1JA006
- F017F1JA033
- 1-10V
- F017F1JB006
- F017F1JB033
- Dali
- F017F1JD006
- F017F1JD033

2700K

Non Dimmable

- F017F2JA006
- F017F2JA033
- 1-10V
- F017F2JB006
- F017F2JB033
- Dali
- F017F2JD006
- F017F2JD033

3000K

Non Dimmable

- F017F3JA006
- F017F3JA033
- 1-10V
- F017F3JB006
- F017F3JB033
- Dali
- F017F3JD006
- F017F3JD033

4000K

Non Dimmable

- F017F4JA006 857,00 €
- F017F4JA033 857,00 €
- 1-10V
- F017F4JB006 891,00 €
- F017F4JB033 891,00 €
- Dali
- F017F4JD006 913,00 €
- F017F4JD033 913,00 €

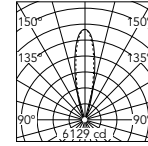

Beam Angle: 25°

h(m)	E(lx)	D(m)
1	6129	0.44
2	1532	0.87
3	681	1.31
4	383	1.74
5	245	2.18

@3000K

Optic Flood 39°

Power Led: 17W - LED 1863 lm ≠ OUTPUT 820 lm - 2200K/CRI 80 / 17W - LED 1932 lm ≠ OUTPUT 850 lm - 2700K/CRI 80 / 17W - LED 2070 lm ≠ OUTPUT 911 lm - 3000K/CRI 80 / 17W - LED 2139 lm ≠ OUTPUT 944 lm - 4000K/CRI 80

2200K

Non Dimmable

- F017F1KA006
- F017F1KA033
- 1-10V
- F017F1KB006
- F017F1KB033
- Dali
- F017F1KD006
- F017F1KD033

2700K

Non Dimmable

- F017F2KA006
- F017F2KA033
- 1-10V
- F017F2KB006
- F017F2KB033
- Dali
- F017F2KD006
- F017F2KD033

3000K

Non Dimmable

- F017F3KA006
- F017F3KA033
- 1-10V
- F017F3KB006
- F017F3KB033
- Dali
- F017F3KD006
- F017F3KD033

4000K

Non Dimmable

- F017F4KA006 857,00 €
- F017F4KA033 857,00 €
- 1-10V
- F017F4KB006 891,00 €
- F017F4KB033 891,00 €
- Dali
- F017F4KD006 913,00 €
- F017F4KD033 913,00 €

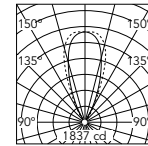

Beam Angle: 39°

h(m)	E(lx)	D(m)
1	1832	0.71
2	458	1.43
3	204	2.14
4	115	2.86
5	73	3.57

@3000K

Optic Elliptical 13° x 40°

Power Led: 17W - LED 1863 lm ≠ OUTPUT 820 lm - 2200K/CRI 80 / 17W - LED 1932 lm ≠ OUTPUT 850 lm - 2700K/CRI 80 / 17W - LED 2070 lm ≠ OUTPUT 911 lm - 3000K/CRI 80 / 17W - LED 2139 lm ≠ OUTPUT 941 lm - 4000K/CRI 80

2200K

Non Dimmable

- F017F1LA006
- F017F1LA033
- 1-10V
- F017F1LB006
- F017F1LB033
- Dali
- F017F1LD006
- F017F1LD033

2700K

Non Dimmable

- F017F2LA006
- F017F2LA033
- 1-10V
- F017F2LB006
- F017F2LB033
- Dali
- F017F2LD006
- F017F2LD033

3000K

Non Dimmable

- F017F3LA006
- F017F3LA033
- 1-10V
- F017F3LB006
- F017F3LB033
- Dali
- F017F3LD006
- F017F3LD033

4000K

Non Dimmable

- F017F4LA006 857,00 €
- F017F4LA033 857,00 €
- 1-10V
- F017F4LB006 891,00 €
- F017F4LB033 891,00 €
- Dali
- F017F4LD006 913,00 €
- F017F4LD033 913,00 €

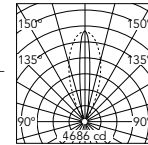

Beam Angle: 13°

h(m)	E(lx)	D(m)
1	4686	0.22
2	1172	0.44
3	521	0.67
4	293	0.89
5	187	1.11

@3000K

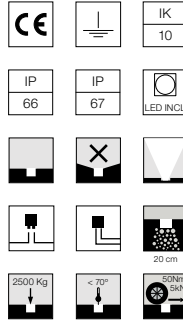
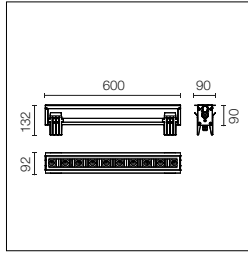

Source LED haute puissance incluse et optique en retrait équipée d'une grille à lamelles asymétrique anti-éblouissement. Alimentation 220-240 V ON-OFF et variable 1-10 V et DALI.
Le coffrage d'installation obligatoire doit être commandé séparément. Précâblé avec les connecteurs rapides H₂O Stop prise/fiche inclus. ACT (Anti Corrosion Treatment) sur demande.

High-power LED source included and rear lenses equipped with anti-glare asymmetrical diffuser grille. 1-10V or DALI on-off and dimmable 220-240V power supply. Compulsory installation box to be ordered separately. Pre-wired with H₂O Stop quick connectors, plug/socket included. ACT (Anti-Corrosion Treatment) upon request.

Optic Spot 15°

Power Led: 17W - LED 1863 lm ≠ OUTPUT 477 lm - 2200K/CRI 80 / 17W - LED 1932 lm ≠ OUTPUT 495 lm - 2700K/CRI 80 / 17W - LED 2070 lm ≠ OUTPUT 530 lm - 3000K/CRI 80 / 17W - LED 2139 lm ≠ OUTPUT 548 lm - 4000K/CRI 80

2200K	2700K	3000K	4000K	
Non Dimmable	Non Dimmable	Non Dimmable	Non Dimmable	
● F017F1QA006	● F017F2QA006	● F017F3QA006	● F017F4QA006	857,00 €
● F017F1QA033	● F017F2QA033	● F017F3QA033	● F017F4QA033	857,00 €
1-10V	1-10V	1-10V	1-10V	
● F017F1QB006	● F017F2QB006	● F017F3QB006	● F017F4QB006	891,00 €
● F017F1QB033	● F017F2QB033	● F017F3QB033	● F017F4QB033	891,00 €
Dali	Dali	Dali	Dali	
● F017F1QD006	● F017F2QD006	● F017F3QD006	● F017F4QD006	913,00 €
● F017F1QD033	● F017F2QD033	● F017F3QD033	● F017F4QD033	913,00 €

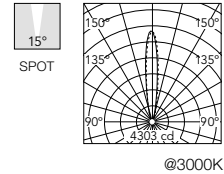

Beam Angle: 15°

h(m)	E(lx)	D(m)
1	4300	0.25
2	1075	0.51
3	478	0.76
4	269	1.02
5	172	1.27

Optic Medium 25°

Power Led: 17W - LED 1863 lm ≠ OUTPUT 505 lm - 2200K/CRI 80 / 17W - LED 1932 lm ≠ OUTPUT 523 lm - 2700K/CRI 80 / 17W - LED 2070 lm ≠ OUTPUT 561 lm - 3000K/CRI 80 / 17W - LED 2139 lm ≠ OUTPUT 579 lm - 4000K/CRI 80

2200K	2700K	3000K	4000K	
Non Dimmable	Non Dimmable	Non Dimmable	Non Dimmable	
● F017F1RA006	● F017F2RA006	● F017F3RA006	● F017F4RA006	857,00 €
● F017F1RA033	● F017F2RA033	● F017F3RA033	● F017F4RA033	857,00 €
1-10V	1-10V	1-10V	1-10V	
● F017F1RB006	● F017F2RB006	● F017F3RB006	● F017F4RB006	891,00 €
● F017F1RB033	● F017F2RB033	● F017F3RB033	● F017F4RB033	891,00 €
Dali	Dali	Dali	Dali	
● F017F1RD006	● F017F2RD006	● F017F3RD006	● F017F4RD006	913,00 €
● F017F1RD033	● F017F2RD033	● F017F3RD033	● F017F4RD033	913,00 €

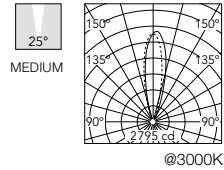

Beam Angle: 25°

h(m)	E(lx)	D(m)
1	2790	0.45
2	698	0.89
3	310	1.34
4	174	1.78
5	112	2.23

Optic Flood 42°

Power Led: 17W - LED 1863 lm ≠ OUTPUT 404 lm - 2200K/CRI 80 / 17W - LED 1932 lm ≠ OUTPUT 419 lm - 2700K/CRI 80 / 17W - LED 2070 lm ≠ OUTPUT 449 lm - 3000K/CRI 80 / 17W - LED 2139 lm ≠ OUTPUT 464 lm - 4000K/CRI 80

2200K	2700K	3000K	4000K	
Non Dimmable	Non Dimmable	Non Dimmable	Non Dimmable	
● F017F1SA006	● F017F2SA006	● F017F3SA006	● F017F4SA006	857,00 €
● F017F1SA033	● F017F2SA033	● F017F3SA033	● F017F4SA033	857,00 €
1-10V	1-10V	1-10V	1-10V	
● F017F1SB006	● F017F2SB006	● F017F3SB006	● F017F4SB006	891,00 €
● F017F1SB033	● F017F2SB033	● F017F3SB033	● F017F4SB033	891,00 €
Dali	Dali	Dali	Dali	
● F017F1SD006	● F017F2SD006	● F017F3SD006	● F017F4SD006	913,00 €
● F017F1SD033	● F017F2SD033	● F017F3SD033	● F017F4SD033	913,00 €

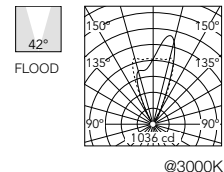

Beam Angle: 42°

h(m)	E(lx)	D(m)
1	983	0.76
2	246	1.51
3	109	2.27
4	61	3.03
5	39	3.78

Optic Elliptical 12° x 40°

Power Led: 17W - LED 1863 lm ≠ OUTPUT 387 lm - 2200K/CRI 80 / 17W - LED 1932 lm ≠ OUTPUT 401 lm - 2700K/CRI 80 / 17W - LED 2070 lm ≠ OUTPUT 430 lm - 3000K/CRI 80 / 17W - LED 2139 lm ≠ OUTPUT 444 lm - 4000K/CRI 80

2200K	2700K	3000K	4000K	
Non Dimmable	Non Dimmable	Non Dimmable	Non Dimmable	
● F017F1TA006	● F017F2TA006	● F017F3TA006	● F017F4TA006	857,00 €
● F017F1TA033	● F017F2TA033	● F017F3TA033	● F017F4TA033	857,00 €
1-10V	1-10V	1-10V	1-10V	
● F017F1TB006	● F017F2TB006	● F017F3TB006	● F017F4TB006	891,00 €
● F017F1TB033	● F017F2TB033	● F017F3TB033	● F017F4TB033	891,00 €
Dali	Dali	Dali	Dali	
● F017F1TD006	● F017F2TD006	● F017F3TD006	● F017F4TD006	913,00 €
● F017F1TD033	● F017F2TD033	● F017F3TD033	● F017F4TD033	913,00 €

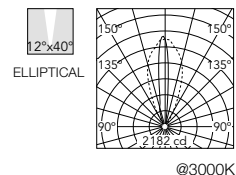

Beam Angle: 12°

h(m)	E(lx)	D(m)
1	2181	0.21
2	545	0.42
3	242	0.62
4	136	0.83
5	87	1.04

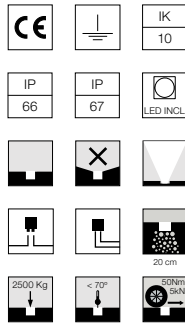
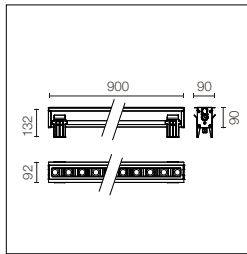

Source LED haute puissance incluse et optique en retrait. Alimentation 220-240 V ON-OFF et variable 1-10 V et DALI. Le coffrage d'installation obligatoire doit être commandé séparément. Précâblé avec les connecteurs rapides H₂O Stop prise/fiche inclus. ACT (Anti Corrosion Treatment) sur demande.

High-power LED source included and rear lenses. 1-10V or DALI on-off and dimmable 220-240V power supply. Compulsory installation box to be ordered separately. Pre-wired with H₂O Stop quick connectors, plug/socket included. ACT (Anti-Corrosion Treatment) upon request.

Optic Spot 16°

Power Led: 26W - LED 2795 lm ≠ OUTPUT 2052 lm - 2200K/CRI 80 / 26W - LED 2898 lm ≠ OUTPUT 2128 lm - 2700K/CRI 80 / 26W - LED 3105 lm ≠ OUTPUT 2454 lm - 3000K/CRI 80 / 26W - LED 3209 lm ≠ OUTPUT 2536 lm - 4000K/CRI 80

2200K	2700K	3000K	4000K	
Non Dimmable	Non Dimmable	Non Dimmable	Non Dimmable	
● F017G1AA006	● F017G2AA006	● F017G3AA006	● F017G4AA006	969,00 €
● F017G1AA033	● F017G2AA033	● F017G3AA033	● F017G4AA033	969,00 €
1-10V	1-10V	1-10V	1-10V	
● F017G1AB006	● F017G2AB006	● F017G3AB006	● F017G4AB006	1.009,00 €
● F017G1AB033	● F017G2AB033	● F017G3AB033	● F017G4AB033	1.009,00 €
Dali	Dali	Dali	Dali	
● F017G1AD006	● F017G2AD006	● F017G3AD006	● F017G4AD006	1.034,00 €
● F017G1AD033	● F017G2AD033	● F017G3AD033	● F017G4AD033	1.034,00 €

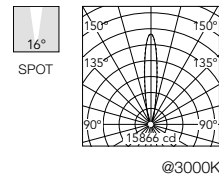

Optic Medium 25°

Power Led: 26W - LED 2795 lm ≠ OUTPUT 2209 lm - 2200K/CRI 80 / 26W - LED 2898 lm ≠ OUTPUT 2291 lm - 2700K/CRI 80 / 26W - LED 3105 lm ≠ OUTPUT 2280 lm - 3000K/CRI 80 / 26W - LED 3209 lm ≠ OUTPUT 2536 lm - 4000K/CRI 80

2200K	2700K	3000K	4000K	
Non Dimmable	Non Dimmable	Non Dimmable	Non Dimmable	
● F017G1BA006	● F017G2BA006	● F017G3BA006	● F017G4BA006	969,00 €
● F017G1BA033	● F017G2BA033	● F017G3BA033	● F017G4BA033	969,00 €
1-10V	1-10V	1-10V	1-10V	
● F017G1BB006	● F017G2BB006	● F017G3BB006	● F017G4BB006	1.009,00 €
● F017G1BB033	● F017G2BB033	● F017G3BB033	● F017G4BB033	1.009,00 €
Dali	Dali	Dali	Dali	
● F017G1BD006	● F017G2BD006	● F017G3BD006	● F017G4BD006	1.034,00 €
● F017G1BD033	● F017G2BD033	● F017G3BD033	● F017G4BD033	1.034,00 €

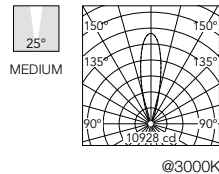

Optic Flood 46°

Power Led: 26W - LED 2795 lm ≠ OUTPUT 1924 lm - 2200K/CRI 80 / 26W - LED 2898 lm ≠ OUTPUT 1995 lm - 2700K/CRI 80 / 26W - LED 3105 lm ≠ OUTPUT 2138 lm - 3000K/CRI 80 / 26W - LED 3209 lm ≠ OUTPUT 2209 lm - 4000K/CRI 80

2200K	2700K	3000K	4000K	
Non Dimmable	Non Dimmable	Non Dimmable	Non Dimmable	
● F017G1CA006	● F017G2CA006	● F017G3CA006	● F017G4CA006	969,00 €
● F017G1CA033	● F017G2CA033	● F017G3CA033	● F017G4CA033	969,00 €
1-10V	1-10V	1-10V	1-10V	
● F017G1CB006	● F017G2CB006	● F017G3CB006	● F017G4CB006	1.009,00 €
● F017G1CB033	● F017G2CB033	● F017G3CB033	● F017G4CB033	1.009,00 €
Dali	Dali	Dali	Dali	
● F017G1CD006	● F017G2CD006	● F017G3CD006	● F017G4CD006	1.034,00 €
● F017G1CD033	● F017G2CD033	● F017G3CD033	● F017G4CD033	1.034,00 €

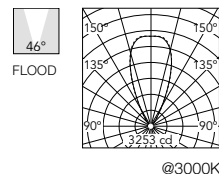

Optic Elliptical 12° x 50°

Power Led: 26W - LED 2795 lm ≠ OUTPUT 1929 lm - 2200K/CRI 80 / 26W - LED 2898 lm ≠ OUTPUT 2001 lm - 2700K/CRI 80 / 26W - LED 3105 lm ≠ OUTPUT 2144 lm - 3000K/CRI 80 / 26W - LED 3209 lm ≠ OUTPUT 2215 lm - 4000K/CRI 80

2200K	2700K	3000K	4000K	
Non Dimmable	Non Dimmable	Non Dimmable	Non Dimmable	
● F017G1DA006	● F017G2DA006	● F017G3DA006	● F017G4DA006	969,00 €
● F017G1DA033	● F017G2DA033	● F017G3DA033	● F017G4DA033	969,00 €
1-10V	1-10V	1-10V	1-10V	
● F017G1DB006	● F017G2DB006	● F017G3DB006	● F017G4DB006	1.009,00 €
● F017G1DB033	● F017G2DB033	● F017G3DB033	● F017G4DB033	1.009,00 €
Dali	Dali	Dali	Dali	
● F017G1DD006	● F017G2DD006	● F017G3DD006	● F017G4DD006	1.034,00 €
● F017G1DD033	● F017G2DD033	● F017G3DD033	● F017G4DD033	1.034,00 €

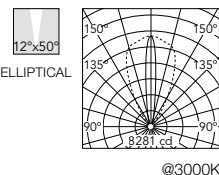

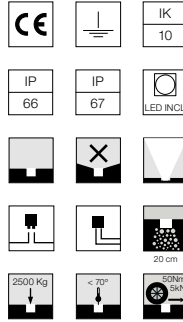
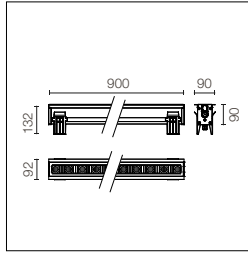

Source LED haute puissance incluse et optique en retrait équipée d'une grille à lamelles anti-éblouissement. Alimentation 220-240 V ON-OFF et variable 1-10 V et DALI.
Le coffrage d'installation obligatoire doit être commandé séparément. Précâblé avec les connecteurs rapides H₂O Stop prise/fiche inclus. ACT (Anti Corrosion Treatment) sur demande.

High-power LED source included and rear lenses equipped with anti-glare diffuser grille. 1-10V or DALI on-off and dimmable 220-240V power supply.
Compulsory installation box to be ordered separately.
Pre-wired with H₂O Stop quick connectors, plug/socket included. ACT (Anti-Corrosion Treatment) upon request.

Optic Spot 16°

Power Led: 26W - LED 2795 lm ≠ OUTPUT 1505 lm - 2200K/CRI 80 / 26W - LED 2898 lm ≠ OUTPUT 1560 lm - 2700K/CRI 80 / 26W - LED 3105 lm ≠ OUTPUT 1672 lm - 3000K/CRI 80 / 26W - LED 3209 lm ≠ OUTPUT 1728 lm - 4000K/CRI 80

2200K	2700K	3000K	4000K	
Non Dimmable	Non Dimmable	Non Dimmable	Non Dimmable	
● F017G1HA006	● F017G2HA006	● F017G3HA006	● F017G4HA006	984,00 €
● F017G1HA033	● F017G2HA033	● F017G3HA033	● F017G4HA033	984,00 €
1-10V	1-10V	1-10V	1-10V	
● F017G1HB006	● F017G2HB006	● F017G3HB006	● F017G4HB006	1.024,00 €
● F017G1HB033	● F017G2HB033	● F017G3HB033	● F017G4HB033	1.024,00 €
Dali	Dali	Dali	Dali	
● F017G1HD006	● F017G2HD006	● F017G3HD006	● F017G4HD006	1.049,00 €
● F017G1HD033	● F017G2HD033	● F017G3HD033	● F017G4HD033	1.049,00 €

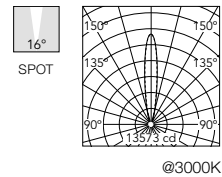

Optic Medium 25°

Power Led: 26W - LED 2795 lm ≠ OUTPUT 1594 lm - 2200K/CRI 80 / 26W - LED 2898 lm ≠ OUTPUT 1653 lm - 2700K/CRI 80 / 26W - LED 3105 lm ≠ OUTPUT 1771 lm - 3000K/CRI 80 / 26W - LED 3209 lm ≠ OUTPUT 1830 lm - 4000K/CRI 80

2200K	2700K	3000K	4000K	
Non Dimmable	Non Dimmable	Non Dimmable	Non Dimmable	
● F017G1JA006	● F017G2JA006	● F017G3JA006	● F017G4JA006	984,00 €
● F017G1JA033	● F017G2JA033	● F017G3JA033	● F017G4JA033	984,00 €
1-10V	1-10V	1-10V	1-10V	
● F017G1JB006	● F017G2JB006	● F017G3JB006	● F017G4JB006	1.024,00 €
● F017G1JB033	● F017G2JB033	● F017G3JB033	● F017G4JB033	1.024,00 €
Dali	Dali	Dali	Dali	
● F017G1JD006	● F017G2JD006	● F017G3JD006	● F017G4JD006	1.049,00 €
● F017G1JD033	● F017G2JD033	● F017G3JD033	● F017G4JD033	1.049,00 €

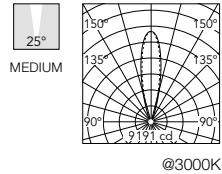

Optic Flood 39°

Power Led: 26W - LED 2795 lm ≠ OUTPUT 1233 lm - 2200K/CRI 80 / 26W - LED 2898 lm ≠ OUTPUT 1278 lm - 2700K/CRI 80 / 26W - LED 3105 lm ≠ OUTPUT 1370 lm - 3000K/CRI 80 / 26W - LED 3209 lm ≠ OUTPUT 1415 lm - 4000K/CRI 80

2200K	2700K	3000K	4000K	
Non Dimmable	Non Dimmable	Non Dimmable	Non Dimmable	
● F017G1KA006	● F017G2KA006	● F017G3KA006	● F017G4KA006	984,00 €
● F017G1KA033	● F017G2KA033	● F017G3KA033	● F017G4KA033	984,00 €
1-10V	1-10V	1-10V	1-10V	
● F017G1KB006	● F017G2KB006	● F017G3KB006	● F017G4KB006	1.024,00 €
● F017G1KB033	● F017G2KB033	● F017G3KB033	● F017G4KB033	1.024,00 €
Dali	Dali	Dali	Dali	
● F017G1KD006	● F017G2KD006	● F017G3KD006	● F017G4KD006	1.049,00 €
● F017G1KD033	● F017G2KD033	● F017G3KD033	● F017G4KD033	1.049,00 €

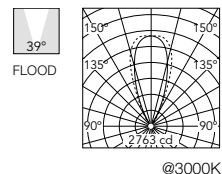

Optic Elliptical 13° x 40°

Power Led: 26W - LED 2795 lm ≠ OUTPUT 1229 lm - 2200K/CRI 80 / 26W - LED 2898 lm ≠ OUTPUT 1275 lm - 2700K/CRI 80 / 26W - LED 3105 lm ≠ OUTPUT 1366 lm - 3000K/CRI 80 / 26W - LED 3209 lm ≠ OUTPUT 1411 lm - 4000K/CRI 80

2200K	2700K	3000K	4000K	
Non Dimmable	Non Dimmable	Non Dimmable	Non Dimmable	
● F017G1LA006	● F017G2LA006	● F017G3LA006	● F017G4LA006	984,00 €
● F017G1LA033	● F017G2LA033	● F017G3LA033	● F017G4LA033	984,00 €
1-10V	1-10V	1-10V	1-10V	
● F017G1LB006	● F017G2LB006	● F017G3LB006	● F017G4LB006	1.024,00 €
● F017G1LB033	● F017G2LB033	● F017G3LB033	● F017G4LB033	1.024,00 €
Dali	Dali	Dali	Dali	
● F017G1LD006	● F017G2LD006	● F017G3LD006	● F017G4LD006	1.049,00 €
● F017G1LD033	● F017G2LD033	● F017G3LD033	● F017G4LD033	1.049,00 €

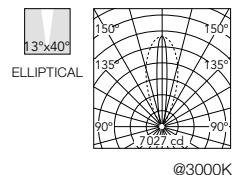

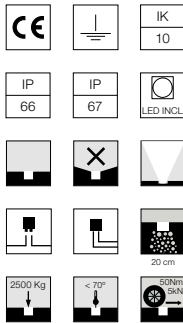
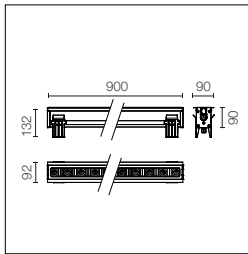

Source LED haute puissance incluse et optique en retrait équipée d'une grille à lamelles asymétrique anti-éblouissement. Alimentation 220-240 V ON-OFF et variable 1-10 V et DALI.
Le coffrage d'installation obligatoire doit être commandé séparément. Précâblé avec les connecteurs rapides H₂O Stop prise/fiche inclus. ACT (Anti Corrosion Treatment) sur demande.

High-power LED source included and rear lenses equipped with anti-glare asymmetrical diffuser grille. 1-10V or DALI on-off and dimmable 220-240V power supply. Compulsory installation box to be ordered separately. Pre-wired with H₂O Stop quick connectors, plug/socket included. ACT (Anti-Corrosion Treatment) upon request.

Optic Spot 15°

Power Led: 26W - LED 2795 lm ≠ OUTPUT 715 lm - 2200K/CRI 80 / 26W - LED 2898 lm ≠ OUTPUT 742 lm - 2700K/CRI 80 / 26W - LED 3105 lm ≠ OUTPUT 795 lm - 3000K/CRI 80 / 26W - LED 3209 lm ≠ OUTPUT 821 lm - 4000K/CRI 80

2200K	2700K	3000K	4000K	
Non Dimmable	Non Dimmable	Non Dimmable	Non Dimmable	
● F017G1QA006	● F017G2QA006	● F017G3QA006	● F017G4QA006	984,00 €
● F017G1QA033	● F017G2QA033	● F017G3QA033	● F017G4QA033	984,00 €
1-10V	1-10V	1-10V	1-10V	
● F017G1QB006	● F017G2QB006	● F017G3QB006	● F017G4QB006	1.024,00 €
● F017G1QB033	● F017G2QB033	● F017G3QB033	● F017G4QB033	1.024,00 €
Dali	Dali	Dali	Dali	
● F017G1QD006	● F017G2QD006	● F017G3QD006	● F017G4QD006	1.049,00 €
● F017G1QD033	● F017G2QD033	● F017G3QD033	● F017G4QD033	1.049,00 €

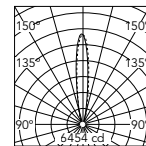

Beam Angle: 15°

h(m)	E(lx)	D(m)
1	6451	0.25
2	1613	0.51
3	717	0.76
4	403	1.02
5	258	1.27

@3000K

Optic Medium 25°

Power Led: 26W - LED 2795 lm ≠ OUTPUT 757 lm - 2200K/CRI 80 / 26W - LED 2898 lm ≠ OUTPUT 785 lm - 2700K/CRI 80 / 26W - LED 3105 lm ≠ OUTPUT 841 lm - 3000K/CRI 80 / 26W - LED 3209 lm ≠ OUTPUT 869 lm - 4000K/CRI 80

2200K	2700K	3000K	4000K	
Non Dimmable	Non Dimmable	Non Dimmable	Non Dimmable	
● F017G1RA006	● F017G2RA006	● F017G3RA006	● F017G4RA006	984,00 €
● F017G1RA033	● F017G2RA033	● F017G3RA033	● F017G4RA033	984,00 €
1-10V	1-10V	1-10V	1-10V	
● F017G1RB006	● F017G2RB006	● F017G3RB006	● F017G4RB006	1.024,00 €
● F017G1RB033	● F017G2RB033	● F017G3RB033	● F017G4RB033	1.024,00 €
Dali	Dali	Dali	Dali	
● F017G1RD006	● F017G2RD006	● F017G3RD006	● F017G4RD006	1.049,00 €
● F017G1RD033	● F017G2RD033	● F017G3RD033	● F017G4RD033	1.049,00 €

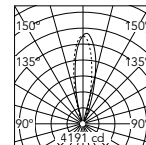

Beam Angle: 25°

h(m)	E(lx)	D(m)
1	4183	0.45
2	1046	0.89
3	465	1.34
4	261	1.78
5	167	2.23

@3000K

Optic Flood 42°

Power Led: 26W - LED 2795 lm ≠ OUTPUT 606 lm - 2200K/CRI 80 / 26W - LED 2898 lm ≠ OUTPUT 628 lm - 2700K/CRI 80 / 26W - LED 3105 lm ≠ OUTPUT 673 lm - 3000K/CRI 80 / 26W - LED 3209 lm ≠ OUTPUT 696 lm - 4000K/CRI 80

2200K	2700K	3000K	4000K	
Non Dimmable	Non Dimmable	Non Dimmable	Non Dimmable	
● F017G1SA006	● F017G2SA006	● F017G3SA006	● F017G4SA006	984,00 €
● F017G1SA033	● F017G2SA033	● F017G3SA033	● F017G4SA033	984,00 €
1-10V	1-10V	1-10V	1-10V	
● F017G1SB006	● F017G2SB006	● F017G3SB006	● F017G4SB006	1.024,00 €
● F017G1SB033	● F017G2SB033	● F017G3SB033	● F017G4SB033	1.024,00 €
Dali	Dali	Dali	Dali	
● F017G1SD006	● F017G2SD006	● F017G3SD006	● F017G4SD006	1.049,00 €
● F017G1SD033	● F017G2SD033	● F017G3SD033	● F017G4SD033	1.049,00 €

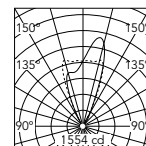

Beam Angle: 42°

h(m)	E(lx)	D(m)
1	1474	0.76
2	368	1.51
3	164	2.27
4	92	3.03
5	59	3.78

@3000K

Optic Elliptical 12° x 40°

Power Led: 26W - LED 2795 lm ≠ OUTPUT 580 lm - 2200K/CRI 80 / 26W - LED 2898 lm ≠ OUTPUT 602 lm - 2700K/CRI 80 / 26W - LED 3105 lm ≠ OUTPUT 645 lm - 3000K/CRI 80 / 26W - LED 3209 lm ≠ OUTPUT 666 lm - 4000K/CRI 80

2200K	2700K	3000K	4000K	
Non Dimmable	Non Dimmable	Non Dimmable	Non Dimmable	
● F017G1TA006	● F017G2TA006	● F017G3TA006	● F017G4TA006	984,00 €
● F017G1TA033	● F017G2TA033	● F017G3TA033	● F017G4TA033	984,00 €
1-10V	1-10V	1-10V	1-10V	
● F017G1TB006	● F017G2TB006	● F017G3TB006	● F017G4TB006	1.024,00 €
● F017G1TB033	● F017G2TB033	● F017G3TB033	● F017G4TB033	1.024,00 €
Dali	Dali	Dali	Dali	
● F017G1TD006	● F017G2TD006	● F017G3TD006	● F017G4TD006	1.049,00 €
● F017G1TD033	● F017G2TD033	● F017G3TD033	● F017G4TD033	1.049,00 €

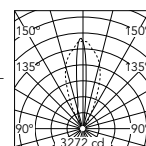

Beam Angle: 12°

h(m)	E(lx)	D(m)
1	3271	0.21
2	818	0.42
3	363	0.62
4	204	0.83
5	131	1.04

@3000K

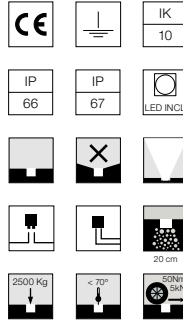
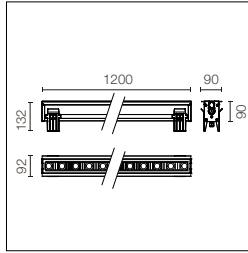

Source LED haute puissance incluse et optique en retrait.
Alimentation 220-240 V ON-OFF et variable 1-10 V et DALI.
Le coffrage d'installation obligatoire doit être commandé séparément.
Précâblé avec les connecteurs rapides H₂O Stop prise/fiche inclus.
ACT (Anti Corrosion Treatment) sur demande.

High-power LED source included and rear lenses. 1-10V or DALI on-off and dimmable 220-240V power supply.
Compulsory installation box to be ordered separately.
Pre-wired with H₂O Stop quick connectors, plug/socket included.
ACT (Anti-Corrosion Treatment) upon request.

Optic Spot 16°

Power Led: 33,5W - LED 3726 lm ≠ OUTPUT 2736 lm - 2200K/CRI 80 / 33,5W - LED 3864 lm ≠ OUTPUT 2837 lm - 2700K/CRI 80 / 33,5W - LED 4140 lm ≠ OUTPUT 3040 lm - 3000K/CRI 80 / 33,5W - LED 4278 lm ≠ OUTPUT 3141 lm - 4000K/CRI 80

2200K	2700K	3000K	4000K	
Non Dimmable	Non Dimmable	Non Dimmable	Non Dimmable	
● F017H1AA006	● F017H2AA006	● F017H3AA006	● F017H4AA006	1.101,00 €
● F017H1AA033	● F017H2AA033	● F017H3AA033	● F017H4AA033	1.101,00 €
1-10V	1-10V	1-10V	1-10V	
● F017H1AB006	● F017H2AB006	● F017H3AB006	● F017H4AB006	1.144,00 €
● F017H1AB033	● F017H2AB033	● F017H3AB033	● F017H4AB033	1.144,00 €
Dali	Dali	Dali	Dali	
● F017H1AD006	● F017H2AD006	● F017H3AD006	● F017H4AD006	1.177,00 €
● F017H1AD033	● F017H2AD033	● F017H3AD033	● F017H4AD033	1.177,00 €

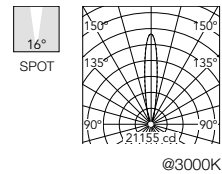

Beam Angle: 16°

h(m)	E(lx)	D(m)
1	21155	0.27
2	5289	0.55
3	2351	0.82
4	1322	1.09
5	846	1.37

@3000K

Optic Medium 25°

Power Led: 33,5W - LED 3726 lm ≠ OUTPUT 2945 lm - 2200K/CRI 80 / 33,5W - LED 3864 lm ≠ OUTPUT 3054 lm - 2700K/CRI 80 / 33,5W - LED 4140 lm ≠ OUTPUT 3272 lm - 3000K/CRI 80 / 33,5W - LED 4278 lm ≠ OUTPUT 3381 lm - 4000K/CRI 80

2200K	2700K	3000K	4000K	
Non Dimmable	Non Dimmable	Non Dimmable	Non Dimmable	
● F017H1BA006	● F017H2BA006	● F017H3BA006	● F017H4BA006	1.101,00 €
● F017H1BA033	● F017H2BA033	● F017H3BA033	● F017H4BA033	1.101,00 €
1-10V	1-10V	1-10V	1-10V	
● F017H1BB006	● F017H2BB006	● F017H3BB006	● F017H4BB006	1.144,00 €
● F017H1BB033	● F017H2BB033	● F017H3BB033	● F017H4BB033	1.144,00 €
Dali	Dali	Dali	Dali	
● F017H1BD006	● F017H2BD006	● F017H3BD006	● F017H4BD006	1.177,00 €
● F017H1BD033	● F017H2BD033	● F017H3BD033	● F017H4BD033	1.177,00 €

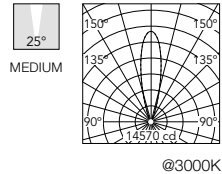

Beam Angle: 25°

h(m)	E(lx)	D(m)
1	14570	0.44
2	3643	0.88
3	1619	1.32
4	911	1.76
5	583	2.20

@3000K

Optic Flood 46°

Power Led: 33,5W - LED 3726 lm ≠ OUTPUT 2565 lm - 2200K/CRI 80 / 33,5W - LED 3864 lm ≠ OUTPUT 2660 lm - 2700K/CRI 80 / 33,5W - LED 4140 lm ≠ OUTPUT 2850 lm - 3000K/CRI 80 / 33,5W - LED 4278 lm ≠ OUTPUT 2945 lm - 4000K/CRI 80

2200K	2700K	3000K	4000K	
Non Dimmable	Non Dimmable	Non Dimmable	Non Dimmable	
● F017H1CA006	● F017H2CA006	● F017H3CA006	● F017H4CA006	1.101,00 €
● F017H1CA033	● F017H2CA033	● F017H3CA033	● F017H4CA033	1.101,00 €
1-10V	1-10V	1-10V	1-10V	
● F017H1CB006	● F017H2CB006	● F017H3CB006	● F017H4CB006	1.144,00 €
● F017H1CB033	● F017H2CB033	● F017H3CB033	● F017H4CB033	1.144,00 €
Dali	Dali	Dali	Dali	
● F017H1CD006	● F017H2CD006	● F017H3CD006	● F017H4CD006	1.177,00 €
● F017H1CD033	● F017H2CD033	● F017H3CD033	● F017H4CD033	1.177,00 €

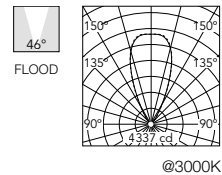

Beam Angle: 46°

h(m)	E(lx)	D(m)
1	4316	0.85
2	1079	1.71
3	480	2.56
4	270	3.42
5	173	4.27

@3000K

Optic Elliptical 12° x 50°

Power Led: 33,5W - LED 3726 lm ≠ OUTPUT 2572 lm - 2200K/CRI 80 / 33,5W - LED 3864 lm ≠ OUTPUT 2668 lm - 2700K/CRI 80 / 33,5W - LED 4140 lm ≠ OUTPUT 2858 lm - 3000K/CRI 80 / 33,5W - LED 4278 lm ≠ OUTPUT 2953 lm - 4000K/CRI 80

2200K	2700K	3000K	4000K	
Non Dimmable	Non Dimmable	Non Dimmable	Non Dimmable	
● F017H1DA006	● F017H2DA006	● F017H3DA006	● F017H4DA006	1.101,00 €
● F017H1DA033	● F017H2DA033	● F017H3DA033	● F017H4DA033	1.101,00 €
1-10V	1-10V	1-10V	1-10V	
● F017H1DB006	● F017H2DB006	● F017H3DB006	● F017H4DB006	1.144,00 €
● F017H1DB033	● F017H2DB033	● F017H3DB033	● F017H4DB033	1.144,00 €
Dali	Dali	Dali	Dali	
● F017H1DD006	● F017H2DD006	● F017H3DD006	● F017H4DD006	1.177,00 €
● F017H1DD033	● F017H2DD033	● F017H3DD033	● F017H4DD033	1.177,00 €

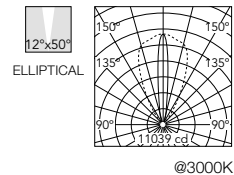

Beam Angle: 12°

h(m)	E(lx)	D(m)
1	11037	0.22
2	2759	0.44
3	1226	0.66
4	690	0.87
5	441	1.09

@3000K

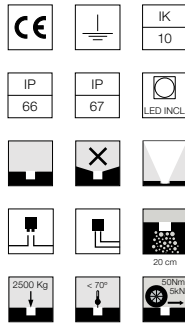
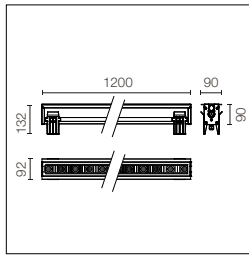

Source LED haute puissance incluse et optique en retrait équipée d'une grille à lamelles anti-éblouissement. Alimentation 220-240 V ON-OFF et variable 1-10 V et DALI. Le coffrage d'installation obligatoire doit être commandé séparément. Précâblé avec les connecteurs rapides H₂O Stop prise/fiche inclus. ACT (Anti Corrosion Treatment) sur demande.

High-power LED source included and rear lenses equipped with anti-glare diffuser grille. 1-10V or DALI on-off and dimmable 220-240V power supply. Compulsory installation box to be ordered separately. Pre-wired with H₂O Stop quick connectors, plug/socket included. ACT (Anti-Corrosion Treatment) upon request.

Optic Spot 16°

Power Led: 33,5W - LED 3726 lm ≠ OUTPUT 2006 lm - 2200K/CRI 80 / 33,5W - LED 3864 lm ≠ OUTPUT 2080 lm - 2700K/CRI 80 / 33,5W - LED 4140 lm ≠ OUTPUT 2229 lm - 3000K/CRI 80 / 33,5W - LED 4278 lm ≠ OUTPUT 2303 lm - 4000K/CRI 80

2200K	2700K	3000K	4000K	
Non Dimmable	Non Dimmable	Non Dimmable	Non Dimmable	
● F017H1HA006	● F017H2HA006	● F017H3HA006	● F017H4HA006	1.121,00 €
● F017H1HA033	● F017H2HA033	● F017H3HA033	● F017H4HA033	1.121,00 €
1-10V	1-10V	1-10V	1-10V	
● F017H1HB006	● F017H2HB006	● F017H3HB006	● F017H4HB006	1.164,00 €
● F017H1HB033	● F017H2HB033	● F017H3HB033	● F017H4HB033	1.164,00 €
Dali	Dali	Dali	Dali	
● F017H1HD006	● F017H2HD006	● F017H3HD006	● F017H4HD006	1.197,00 €
● F017H1HD033	● F017H2HD033	● F017H3HD033	● F017H4HD033	1.197,00 €

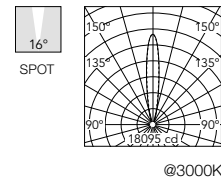

Optic Medium 25°

Power Led: 33,5W - LED 3726 lm ≠ OUTPUT 2125 lm - 2200K/CRI 80 / 33,5W - LED 3864 lm ≠ OUTPUT 2203 lm - 2700K/CRI 80 / 33,5W - LED 4140 lm ≠ OUTPUT 2361 lm - 3000K/CRI 80 / 33,5W - LED 4278 lm ≠ OUTPUT 2439 lm - 4000K/CRI 80

2200K	2700K	3000K	4000K	
Non Dimmable	Non Dimmable	Non Dimmable	Non Dimmable	
● F017H1JA006	● F017H2JA006	● F017H3JA006	● F017H4JA006	1.121,00 €
● F017H1JA033	● F017H2JA033	● F017H3JA033	● F017H4JA033	1.121,00 €
1-10V	1-10V	1-10V	1-10V	
● F017H1JB006	● F017H2JB006	● F017H3JB006	● F017H4JB006	1.164,00 €
● F017H1JB033	● F017H2JB033	● F017H3JB033	● F017H4JB033	1.164,00 €
Dali	Dali	Dali	Dali	
● F017H1JD006	● F017H2JD006	● F017H3JD006	● F017H4JD006	1.197,00 €
● F017H1JD033	● F017H2JD033	● F017H3JD033	● F017H4JD033	1.197,00 €

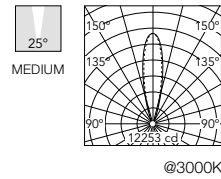

Optic Flood 39°

Power Led: 33,5W - LED 3726 lm ≠ OUTPUT 1643 lm - 2200K/CRI 80 / 33,5W - LED 3864 lm ≠ OUTPUT 1704 lm - 2700K/CRI 80 / 33,5W - LED 4140 lm ≠ OUTPUT 1826 lm - 3000K/CRI 80 / 33,5W - LED 4278 lm ≠ OUTPUT 1887 lm - 4000K/CRI 80

2200K	2700K	3000K	4000K	
Non Dimmable	Non Dimmable	Non Dimmable	Non Dimmable	
● F017H1KA006	● F017H2KA006	● F017H3KA006	● F017H4KA006	1.121,00 €
● F017H1KA033	● F017H2KA033	● F017H3KA033	● F017H4KA033	1.121,00 €
1-10V	1-10V	1-10V	1-10V	
● F017H1KB006	● F017H2KB006	● F017H3KB006	● F017H4KB006	1.164,00 €
● F017H1KB033	● F017H2KB033	● F017H3KB033	● F017H4KB033	1.164,00 €
Dali	Dali	Dali	Dali	
● F017H1KD006	● F017H2KD006	● F017H3KD006	● F017H4KD006	1.197,00 €
● F017H1KD033	● F017H2KD033	● F017H3KD033	● F017H4KD033	1.197,00 €

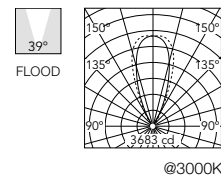

Optic Elliptical 13° x 40°

Power Led: 33,5W - LED 3726 lm ≠ OUTPUT 1639 lm - 2200K/CRI 80 / 33,5W - LED 3864 lm ≠ OUTPUT 1700 lm - 2700K/CRI 80 / 33,5W - LED 4140 lm ≠ OUTPUT 1821 lm - 3000K/CRI 80 / 33,5W - LED 4278 lm ≠ OUTPUT 1882 lm - 4000K/CRI 80

2200K	2700K	3000K	4000K	
Non Dimmable	Non Dimmable	Non Dimmable	Non Dimmable	
● F017H1LA006	● F017H2LA006	● F017H3LA006	● F017H4LA006	1.121,00 €
● F017H1LA033	● F017H2LA033	● F017H3LA033	● F017H4LA033	1.121,00 €
1-10V	1-10V	1-10V	1-10V	
● F017H1LB006	● F017H2LB006	● F017H3LB006	● F017H4LB006	1.164,00 €
● F017H1LB033	● F017H2LB033	● F017H3LB033	● F017H4LB033	1.164,00 €
Dali	Dali	Dali	Dali	
● F017H1LD006	● F017H2LD006	● F017H3LD006	● F017H4LD006	1.197,00 €
● F017H1LD033	● F017H2LD033	● F017H3LD033	● F017H4LD033	1.197,00 €

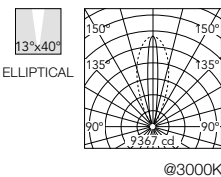

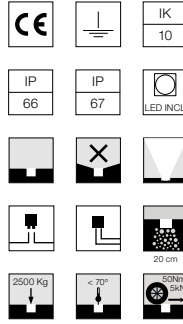
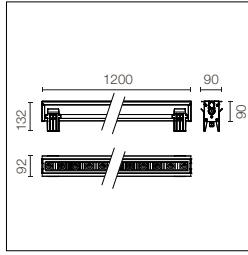

Source LED haute puissance incluse et optique en retrait équipée d'une grille à lamelles asymétrique anti-éblouissement. Alimentation 220-240 V ON-OFF et variable 1-10 V et DALI.
Le coffrage d'installation obligatoire doit être commandé séparément. Précâblé avec les connecteurs rapides H₂O Stop prise/fiche inclus. ACT (Anti Corrosion Treatment) sur demande.

High-power LED source included and rear lenses equipped with anti-glare asymmetrical diffuser grille. 1-10V or DALI on-off and dimmable 220-240V power supply. Compulsory installation box to be ordered separately. Pre-wired with H₂O Stop quick connectors, plug/socket included. ACT (Anti-Corrosion Treatment) upon request.

Optic Spot 15°

Power Led: 33,5W - LED 3726 lm ≠ OUTPUT 954 lm - 2200K/CRI 80 / 33,5W - LED 3864 lm ≠ OUTPUT 989 lm - 2700K/CRI 80 / 33,5W - LED 4140 lm ≠ OUTPUT 1059 lm - 3000K/CRI 80 / 33,5W - LED 4278 lm ≠ OUTPUT 1095 lm - 4000K/CRI 80

2200K	2700K	3000K	4000K	
Non Dimmable	Non Dimmable	Non Dimmable	Non Dimmable	
● F017H1QA006	● F017H2QA006	● F017H3QA006	● F017H4QA006	1.121,00 €
● F017H1QA033	● F017H2QA033	● F017H3QA033	● F017H4QA033	1.121,00 €
1-10V	1-10V	1-10V	1-10V	
● F017H1QB006	● F017H2QB006	● F017H3QB006	● F017H4QB006	1.164,00 €
● F017H1QB033	● F017H2QB033	● F017H3QB033	● F017H4QB033	1.164,00 €
Dali	Dali	Dali	Dali	
● F017H1QD006	● F017H2QD006	● F017H3QD006	● F017H4QD006	1.197,00 €
● F017H1QD033	● F017H2QD033	● F017H3QD033	● F017H4QD033	1.197,00 €

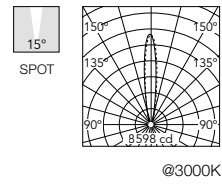

Optic Medium 25°

Power Led: 33,5W - LED 3726 lm ≠ OUTPUT 1009 lm - 2200K/CRI 80 / 33,5W - LED 3864 lm ≠ OUTPUT 1046 lm - 2700K/CRI 80 / 33,5W - LED 4140 lm ≠ OUTPUT 1121 lm - 3000K/CRI 80 / 33,5W - LED 4278 lm ≠ OUTPUT 1158 lm - 4000K/CRI 80

2200K	2700K	3000K	4000K	
Non Dimmable	Non Dimmable	Non Dimmable	Non Dimmable	
● F017H1RA006	● F017H2RA006	● F017H3RA006	● F017H4RA006	1.121,00 €
● F017H1RA033	● F017H2RA033	● F017H3RA033	● F017H4RA033	1.121,00 €
1-10V	1-10V	1-10V	1-10V	
● F017H1RB006	● F017H2RB006	● F017H3RB006	● F017H4RB006	1.164,00 €
● F017H1RB033	● F017H2RB033	● F017H3RB033	● F017H4RB033	1.164,00 €
Dali	Dali	Dali	Dali	
● F017H1RD006	● F017H2RD006	● F017H3RD006	● F017H4RD006	1.197,00 €
● F017H1RD033	● F017H2RD033	● F017H3RD033	● F017H4RD033	1.197,00 €

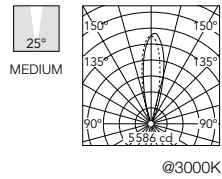

Optic Flood 42°

Power Led: 33,5W - LED 3726 lm ≠ OUTPUT 808 lm - 2200K/CRI 80 / 33,5W - LED 3864 lm ≠ OUTPUT 838 lm - 2700K/CRI 80 / 33,5W - LED 4140 lm ≠ OUTPUT 898 lm - 3000K/CRI 80 / 33,5W - LED 4278 lm ≠ OUTPUT 928 lm - 4000K/CRI 80

2200K	2700K	3000K	4000K	
Non Dimmable	Non Dimmable	Non Dimmable	Non Dimmable	
● F017H1SA006	● F017H2SA006	● F017H3SA006	● F017H4SA006	1.121,00 €
● F017H1SA033	● F017H2SA033	● F017H3SA033	● F017H4SA033	1.121,00 €
1-10V	1-10V	1-10V	1-10V	
● F017H1SB006	● F017H2SB006	● F017H3SB006	● F017H4SB006	1.164,00 €
● F017H1SB033	● F017H2SB033	● F017H3SB033	● F017H4SB033	1.164,00 €
Dali	Dali	Dali	Dali	
● F017H1SD006	● F017H2SD006	● F017H3SD006	● F017H4SD006	1.197,00 €
● F017H1SD033	● F017H2SD033	● F017H3SD033	● F017H4SD033	1.197,00 €

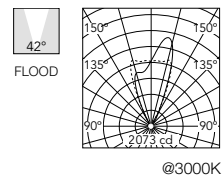

Optic Elliptical 12° x 40°

Power Led: 33,5W - LED 3726 lm ≠ OUTPUT 773 lm - 2200K/CRI 80 / 33,5W - LED 3864 lm ≠ OUTPUT 802 lm - 2700K/CRI 80 / 33,5W - LED 4140 lm ≠ OUTPUT 859 lm - 3000K/CRI 80 / 33,5W - LED 4278 lm ≠ OUTPUT 888 lm - 4000K/CRI 80

2200K	2700K	3000K	4000K	
Non Dimmable	Non Dimmable	Non Dimmable	Non Dimmable	
● F017H1TA006	● F017H2TA006	● F017H3TA006	● F017H4TA006	1.121,00 €
● F017H1TA033	● F017H2TA033	● F017H3TA033	● F017H4TA033	1.121,00 €
1-10V	1-10V	1-10V	1-10V	
● F017H1TB006	● F017H2TB006	● F017H3TB006	● F017H4TB006	1.164,00 €
● F017H1TB033	● F017H2TB033	● F017H3TB033	● F017H4TB033	1.164,00 €
Dali	Dali	Dali	Dali	
● F017H1TD006	● F017H2TD006	● F017H3TD006	● F017H4TD006	1.197,00 €
● F017H1TD033	● F017H2TD033	● F017H3TD033	● F017H4TD033	1.197,00 €

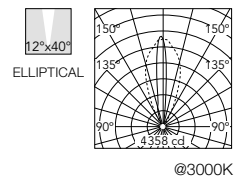

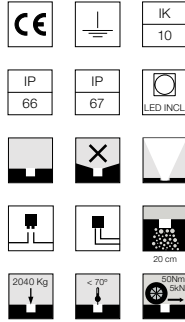
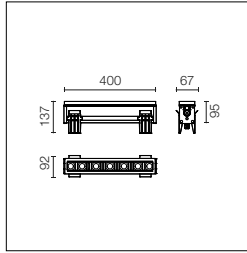

Source LED haute puissance incluse et optique en retrait. Alimentation 220-240 V ON-OFF et variable 1-10 V et DALI. Le coffrage d'installation obligatoire doit être commandé séparément. Précâblé avec les connecteurs rapides H₂O Stop prise/fiche inclus. ACT (Anti Corrosion Treatment) sur demande.

High-power LED source included and rear lenses. 1-10V or DALI on-off and dimmable 220-240V power supply. Compulsory installation box to be ordered separately. Pre-wired with H₂O Stop quick connectors, plug/socket included. ACT (Anti-Corrosion Treatment) upon request.

Optic Spot 16°

Power Led: 12,5W - LED 1304 lm ≠ OUTPUT 958 lm - 2200K/CRI 80 / 12,5W - LED 1352 lm ≠ OUTPUT 993 lm - 2700K/CRI 80 / 12,5W - LED 1449 lm ≠ OUTPUT 1064 lm - 3000K/CRI 80 / 12,5W - LED 1497 lm ≠ OUTPUT 1100 lm - 4000K/CRI 80

2200K

Non Dimmable

- F017N1AA006
- F017N1AA033
- 1-10V
- F017N1AB006
- F017N1AB033
- Dali
- F017N1AD006
- F017N1AD033

2700K

Non Dimmable

- F017N2AA006
- F017N2AA033
- 1-10V
- F017N2AB006
- F017N2AB033
- Dali
- F017N2AD006
- F017N2AD033

3000K

Non Dimmable

- F017N3AA006
- F017N3AA033
- 1-10V
- F017N3AB006
- F017N3AB033
- Dali
- F017N3AD006
- F017N3AD033

4000K

Non Dimmable

- F017N4AA006
- F017N4AA033
- 1-10V
- F017N4AB006
- F017N4AB033
- Dali
- F017N4AD006
- F017N4AD033

685,00 €
685,00 €
712,00 €
712,00 €
729,00 €
729,00 €

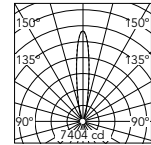

Beam Angle: 16°

h(m)	E(lx)	D(m)
1	7404	0.27
2	1851	0.55
3	823	0.82
4	463	1.09
5	296	1.37

@3000K

Optic Medium 25°

Power Led: 12,5W - LED 1304 lm ≠ OUTPUT 1031 lm - 2200K/CRI 80 / 12,5W - LED 1352 lm ≠ OUTPUT 1069 lm - 2700K/CRI 80 / 12,5W - LED 1449 lm ≠ OUTPUT 1146 lm - 3000K/CRI 80 / 12,5W - LED 1497 lm ≠ OUTPUT 1184 lm - 4000K/CRI 80

2200K

Non Dimmable

- F017N1BA006
- F017N1BA033
- 1-10V
- F017N1BB006
- F017N1BB033
- Dali
- F017N1BD006
- F017N1BD033

2700K

Non Dimmable

- F017N2BA006
- F017N2BA033
- 1-10V
- F017N2BB006
- F017N2BB033
- Dali
- F017N2BD006
- F017N2BD033

3000K

Non Dimmable

- F017N3BA006
- F017N3BA033
- 1-10V
- F017N3BB006
- F017N3BB033
- Dali
- F017N3BD006
- F017N3BD033

4000K

Non Dimmable

- F017N4BA006
- F017N4BA033
- 1-10V
- F017N4BB006
- F017N4BB033
- Dali
- F017N4BD006
- F017N4BD033

685,00 €
685,00 €
712,00 €
712,00 €
729,00 €
729,00 €

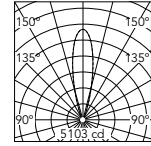

Beam Angle: 25°

h(m)	E(lx)	D(m)
1	5103	0.44
2	1276	0.88
3	567	1.32
4	319	1.76
5	204	2.20

@3000K

Optic Flood 46°

Power Led: 12,5W - LED 1304 lm ≠ OUTPUT 898 lm - 2200K/CRI 80 / 12,5W - LED 1352 lm ≠ OUTPUT 931 lm - 2700K/CRI 80 / 12,5W - LED 1449 lm ≠ OUTPUT 998 lm - 3000K/CRI 80 / 12,5W - LED 1497 lm ≠ OUTPUT 1031 lm - 4000K/CRI 80

2200K

Non Dimmable

- F017N1CA006
- F017N1CA033
- 1-10V
- F017N1CB006
- F017N1CB033
- Dali
- F017N1CD006
- F017N1CD033

2700K

Non Dimmable

- F017N2CA006
- F017N2CA033
- 1-10V
- F017N2CB006
- F017N2CB033
- Dali
- F017N2CD006
- F017N2CD033

3000K

Non Dimmable

- F017N3CA006
- F017N3CA033
- 1-10V
- F017N3CB006
- F017N3CB033
- Dali
- F017N3CD006
- F017N3CD033

4000K

Non Dimmable

- F017N4CA006
- F017N4CA033
- 1-10V
- F017N4CB006
- F017N4CB033
- Dali
- F017N4CD006
- F017N4CD033

685,00 €
685,00 €
712,00 €
712,00 €
729,00 €
729,00 €

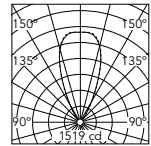

Beam Angle: 46°

h(m)	E(lx)	D(m)
1	1511	0.85
2	378	1.71
3	168	2.56
4	94	3.42
5	60	4.27

@3000K

Optic Elliptical 12° x 50°

Power Led: 12,5W - LED 1304 lm ≠ OUTPUT 901 lm - 2200K/CRI 80 / 12,5W - LED 1352 lm ≠ OUTPUT 934 lm - 2700K/CRI 80 / 12,5W - LED 1449 lm ≠ OUTPUT 1001 lm - 3000K/CRI 80 / 12,5W - LED 1497 lm ≠ OUTPUT 1034 lm - 4000K/CRI 80

2200K

Non Dimmable

- F017N1DA006
- F017N1DA033
- 1-10V
- F017N1DB006
- F017N1DB033
- Dali
- F017N1DD006
- F017N1DD033

2700K

Non Dimmable

- F017N2DA006
- F017N2DA033
- 1-10V
- F017N2DB006
- F017N2DB033
- Dali
- F017N2DD006
- F017N2DD033

3000K

Non Dimmable

- F017N3DA006
- F017N3DA033
- 1-10V
- F017N3DB006
- F017N3DB033
- Dali
- F017N3DD006
- F017N3DD033

4000K

Non Dimmable

- F017N4DA006
- F017N4DA033
- 1-10V
- F017N4DB006
- F017N4DB033
- Dali
- F017N4DD006
- F017N4DD033

685,00 €
685,00 €
712,00 €
712,00 €
729,00 €
729,00 €

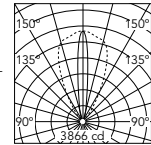

Beam Angle: 12°

h(m)	E(lx)	D(m)
1	3866	0.22
2	966	0.44
3	430	0.66
4	242	0.87
5	155	1.09

@3000K

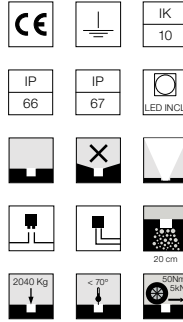
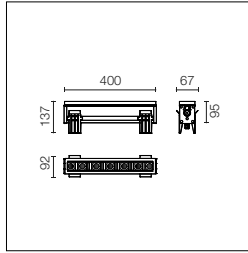

Source LED haute puissance incluse et optique en retrait équipée d'une grille à lamelles anti-éblouissement. Alimentation 220-240 V ON-OFF et variable 1-10 V et DALI. Le coffrage d'installation obligatoire doit être commandé séparément. Précâblé avec les connecteurs rapides H₂O Stop prise/fiche inclus. ACT (Anti Corrosion Treatment) sur demande.

High-power LED source included and rear lenses equipped with anti-glare diffuser grille. 1-10V or DALI on-off and dimmable 220-240V power supply. Compulsory installation box to be ordered separately. Pre-wired with H₂O Stop quick connectors, plug/socket included. ACT (Anti-Corrosion Treatment) upon request.

Optic Spot 16°

Power Led: 12,5W - LED 1304 lm ≠ OUTPUT 702 lm - 2200K/CRI 80 / 12,5W - LED 1352 lm ≠ OUTPUT 728 lm - 2700K/CRI 80 / 12,5W - LED 1449 lm ≠ OUTPUT 780 lm - 3000K/CRI 80 / 12,5W - LED 1497 lm ≠ OUTPUT 806 lm - 4000K/CRI 80

2200K	2700K	3000K	4000K	
Non Dimmable	Non Dimmable	Non Dimmable	Non Dimmable	
● F017N1HA006	● F017N2HA006	● F017N3HA006	● F017N4HA006	692,00 €
● F017N1HA033	● F017N2HA033	● F017N3HA033	● F017N4HA033	692,00 €
1-10V	1-10V	1-10V	1-10V	
● F017N1HB006	● F017N2HB006	● F017N3HB006	● F017N4HB006	719,00 €
● F017N1HB033	● F017N2HB033	● F017N3HB033	● F017N4HB033	719,00 €
Dali	Dali	Dali	Dali	
● F017N1HD006	● F017N2HD006	● F017N3HD006	● F017N4HD006	736,00 €
● F017N1HD033	● F017N2HD033	● F017N3HD033	● F017N4HD033	736,00 €

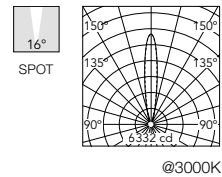

Beam Angle: 16°

h(m)	E(ft)	D(m)
1	6332	0.28
2	1583	0.56
3	704	0.83
4	396	1.11
5	253	1.39

Optic Medium 25°

Power Led: 12,5W - LED 1304 lm ≠ OUTPUT 744 lm - 2200K/CRI 80 / 12,5W - LED 1352 lm ≠ OUTPUT 772 lm - 2700K/CRI 80 / 12,5W - LED 1449 lm ≠ OUTPUT 827 lm - 3000K/CRI 80 / 12,5W - LED 1497 lm ≠ OUTPUT 854 lm - 4000K/CRI 80

2200K	2700K	3000K	4000K	
Non Dimmable	Non Dimmable	Non Dimmable	Non Dimmable	
● F017N1JA006	● F017N2JA006	● F017N3JA006	● F017N4JA006	692,00 €
● F017N1JA033	● F017N2JA033	● F017N3JA033	● F017N4JA033	692,00 €
1-10V	1-10V	1-10V	1-10V	
● F017N1JB006	● F017N2JB006	● F017N3JB006	● F017N4JB006	719,00 €
● F017N1JB033	● F017N2JB033	● F017N3JB033	● F017N4JB033	719,00 €
Dali	Dali	Dali	Dali	
● F017N1JD006	● F017N2JD006	● F017N3JD006	● F017N4JD006	736,00 €
● F017N1JD033	● F017N2JD033	● F017N3JD033	● F017N4JD033	736,00 €

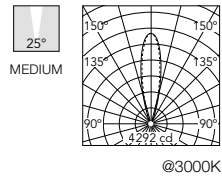

Beam Angle: 25°

h(m)	E(ft)	D(m)
1	4292	0.44
2	1073	0.87
3	477	1.31
4	268	1.74
5	172	2.18

Optic Flood 39°

Power Led: 12,5W - LED 1304 lm ≠ OUTPUT 576 lm - 2200K/CRI 80 / 12,5W - LED 1352 lm ≠ OUTPUT 597 lm - 2700K/CRI 80 / 12,5W - LED 1449 lm ≠ OUTPUT 639 lm - 3000K/CRI 80 / 12,5W - LED 1497 lm ≠ OUTPUT 661 lm - 4000K/CRI 80

2200K	2700K	3000K	4000K	
Non Dimmable	Non Dimmable	Non Dimmable	Non Dimmable	
● F017N1KA006	● F017N2KA006	● F017N3KA006	● F017N4KA006	692,00 €
● F017N1KA033	● F017N2KA033	● F017N3KA033	● F017N4KA033	692,00 €
1-10V	1-10V	1-10V	1-10V	
● F017N1KB006	● F017N2KB006	● F017N3KB006	● F017N4KB006	719,00 €
● F017N1KB033	● F017N2KB033	● F017N3KB033	● F017N4KB033	719,00 €
Dali	Dali	Dali	Dali	
● F017N1KD006	● F017N2KD006	● F017N3KD006	● F017N4KD006	736,00 €
● F017N1KD033	● F017N2KD033	● F017N3KD033	● F017N4KD033	736,00 €

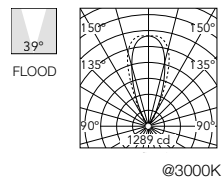

Beam Angle: 39°

h(m)	E(ft)	D(m)
1	1285	0.71
2	321	1.43
3	143	2.14
4	80	2.86
5	51	3.57

Optic Elliptical 13° x 40°

Power Led: 12,5W - LED 1304 lm ≠ OUTPUT 574 lm - 2200K/CRI 80 / 12,5W - LED 1352 lm ≠ OUTPUT 595 lm - 2700K/CRI 80 / 12,5W - LED 1449 lm ≠ OUTPUT 638 lm - 3000K/CRI 80 / 12,5W - LED 1497 lm ≠ OUTPUT 659 lm - 4000K/CRI 80

2200K	2700K	3000K	4000K	
Non Dimmable	Non Dimmable	Non Dimmable	Non Dimmable	
● F017N1LA006	● F017N2LA006	● F017N3LA006	● F017N4LA006	692,00 €
● F017N1LA033	● F017N2LA033	● F017N3LA033	● F017N4LA033	692,00 €
1-10V	1-10V	1-10V	1-10V	
● F017N1LB006	● F017N2LB006	● F017N3LB006	● F017N4LB006	719,00 €
● F017N1LB033	● F017N2LB033	● F017N3LB033	● F017N4LB033	719,00 €
Dali	Dali	Dali	Dali	
● F017N1LD006	● F017N2LD006	● F017N3LD006	● F017N4LD006	736,00 €
● F017N1LD033	● F017N2LD033	● F017N3LD033	● F017N4LD033	736,00 €

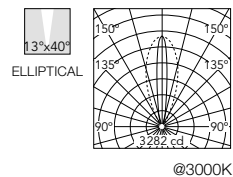

Beam Angle: 13°

h(m)	E(ft)	D(m)
1	3282	0.22
2	820	0.44
3	365	0.67
4	205	0.89
5	131	1.11

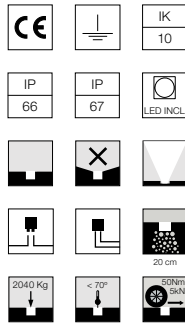
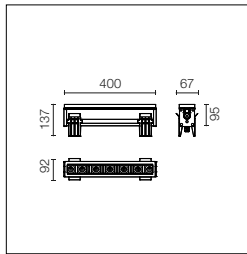

Source LED haute puissance incluse et optique en retrait équipée d'une grille à lamelles asymétrique anti-éblouissement. Alimentation 220-240 V ON-OFF et variable 1-10 V et DALI.
Le coffrage d'installation obligatoire doit être commandé séparément. Précâblé avec les connecteurs rapides H₂O Stop prise/fiche inclus. ACT (Anti Corrosion Treatment) sur demande.

High-power LED source included and rear lenses equipped with anti-glare asymmetrical diffuser grille. 1-10V or DALI on-off and dimmable 220-240V power supply. Compulsory installation box to be ordered separately. Pre-wired with H₂O Stop quick connectors, plug/socket included. ACT (Anti-Corrosion Treatment) upon request.

Optic Spot 15°

Power Led: 12,5W - LED 1304 lm ≠ OUTPUT 334 lm - 2200K/CRI 80 / 12,5W - LED 1352 lm ≠ OUTPUT 346 lm - 2700K/CRI 80 / 12,5W - LED 1449 lm ≠ OUTPUT 371 lm - 3000K/CRI 80 / 12,5W - LED 1497 lm ≠ OUTPUT 383 lm - 4000K/CRI 80

2200K

- Non Dimmable
- F017N1QA006
- F017N1QA033
- 1-10V
- F017N1QB006
- F017N1QB033
- Dali
- F017N1QD006
- F017N1QD033

2700K

- Non Dimmable
- F017N2QA006
- F017N2QA033
- 1-10V
- F017N2QB006
- F017N2QB033
- Dali
- F017N2QD006
- F017N2QD033

3000K

- Non Dimmable
- F017N3QA006
- F017N3QA033
- 1-10V
- F017N3QB006
- F017N3QB033
- Dali
- F017N3QD006
- F017N3QD033

4000K

- Non Dimmable
- F017N4QA006 692,00 €
- F017N4QA033 692,00 €
- 1-10V
- F017N4QB006 719,00 €
- F017N4QB033 719,00 €
- Dali
- F017N4QD006 736,00 €
- F017N4QD033 736,00 €

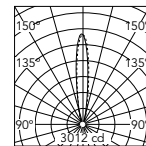

Beam Angle: 15°			
h(m)	E(lx)	D(m)	
1	3010	0.25	
2	753	0.51	
3	334	0.76	
4	188	1.02	
5	120	1.27	

@3000K

Optic Medium 25°

Power Led: 12,5W - LED 1304 lm ≠ OUTPUT 353 lm - 2200K/CRI 80 / 12,5W - LED 1352 lm ≠ OUTPUT 367 lm - 2700K/CRI 80 / 12,5W - LED 1449 lm ≠ OUTPUT 393 lm - 3000K/CRI 80 / 12,5W - LED 1497 lm ≠ OUTPUT 406 lm - 4000K/CRI 80

2200K

- Non Dimmable
- F017N1RA006
- F017N1RA033
- 1-10V
- F017N1RB006
- F017N1RB033
- Dali
- F017N1RD006
- F017N1RD033

2700K

- Non Dimmable
- F017N2RA006
- F017N2RA033
- 1-10V
- F017N2RB006
- F017N2RB033
- Dali
- F017N2RD006
- F017N2RD033

3000K

- Non Dimmable
- F017N3RA006
- F017N3RA033
- 1-10V
- F017N3RB006
- F017N3RB033
- Dali
- F017N3RD006
- F017N3RD033

4000K

- Non Dimmable
- F017N4RA006 692,00 €
- F017N4RA033 692,00 €
- 1-10V
- F017N4RB006 719,00 €
- F017N4RB033 719,00 €
- Dali
- F017N4RD006 736,00 €
- F017N4RD033 736,00 €

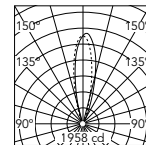

Beam Angle: 25°			
h(m)	E(lx)	D(m)	
1	1955	0.45	
2	489	0.89	
3	217	1.34	
4	122	1.78	
5	78	2.23	

@3000K

Optic Flood 42°

Power Led: 12,5W - LED 1304 lm ≠ OUTPUT 283 lm - 2200K/CRI 80 / 12,5W - LED 1352 lm ≠ OUTPUT 294 lm - 2700K/CRI 80 / 12,5W - LED 1449 lm ≠ OUTPUT 314 lm - 3000K/CRI 80 / 12,5W - LED 1497 lm ≠ OUTPUT 325 lm - 4000K/CRI 80

2200K

- Non Dimmable
- F017N1SA006
- F017N1SA033
- 1-10V
- F017N1SB006
- F017N1SB033
- Dali
- F017N1SD006
- F017N1SD033

2700K

- Non Dimmable
- F017N2SA006
- F017N2SA033
- 1-10V
- F017N2SB006
- F017N2SB033
- Dali
- F017N2SD006
- F017N2SD033

3000K

- Non Dimmable
- F017N3SA006
- F017N3SA033
- 1-10V
- F017N3SB006
- F017N3SB033
- Dali
- F017N3SD006
- F017N3SD033

4000K

- Non Dimmable
- F017N4SA006 692,00 €
- F017N4SA033 692,00 €
- 1-10V
- F017N4SB006 719,00 €
- F017N4SB033 719,00 €
- Dali
- F017N4SD006 736,00 €
- F017N4SD033 736,00 €

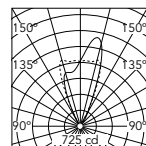

Beam Angle: 42°			
h(m)	E(lx)	D(m)	
1	688	0.76	
2	172	1.51	
3	76	2.27	
4	43	3.03	
5	28	3.78	

@3000K

Optic Elliptical 12° x 40°

Power Led: 12,5W - LED 1304 lm ≠ OUTPUT 271 lm - 2200K/CRI 80 / 12,5W - LED 1352 lm ≠ OUTPUT 281 lm - 2700K/CRI 80 / 12,5W - LED 1449 lm ≠ OUTPUT 301 lm - 3000K/CRI 80 / 12,5W - LED 1497 lm ≠ OUTPUT 311 lm - 4000K/CRI 80

2200K

- Non Dimmable
- F017N1TA006
- F017N1TA033
- 1-10V
- F017N1TB006
- F017N1TB033
- Dali
- F017N1TD006
- F017N1TD033

2700K

- Non Dimmable
- F017N2TA006
- F017N2TA033
- 1-10V
- F017N2TB006
- F017N2TB033
- Dali
- F017N2TD006
- F017N2TD033

3000K

- Non Dimmable
- F017N3TA006
- F017N3TA033
- 1-10V
- F017N3TB006
- F017N3TB033
- Dali
- F017N3TD006
- F017N3TD033

4000K

- Non Dimmable
- F017N4TA006 692,00 €
- F017N4TA033 692,00 €
- 1-10V
- F017N4TB006 719,00 €
- F017N4TB033 719,00 €
- Dali
- F017N4TD006 736,00 €
- F017N4TD033 736,00 €

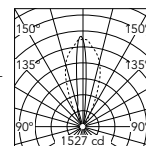

Beam Angle: 12°			
h(m)	E(lx)	D(m)	
1	1526	0.21	
2	382	0.42	
3	170	0.62	
4	95	0.83	
5	61	1.04	

@3000K

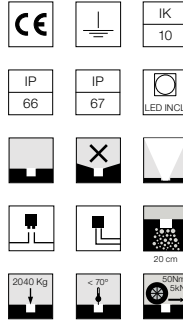
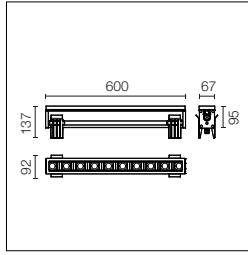

Source LED haute puissance incluse et optique en retrait.
 Alimentation 220-240 V ON-OFF et variable 1-10 V et DALI.
 Le coffrage d'installation obligatoire doit être commandé séparément.
 Précâblé avec les connecteurs rapides H₂O Stop prise/fiche inclus.
 ACT (Anti Corrosion Treatment) sur demande.

High-power LED source included and rear lenses. 1-10V or DALI on-off and dimmable 220-240V power supply.
 Compulsory installation box to be ordered separately.
 Pre-wired with H₂O Stop quick connectors, plug/socket included.
 ACT (Anti-Corrosion Treatment) upon request.

Optic Spot 16°

Power Led: 17W - LED 1863 lm ≠ OUTPUT 1368 lm - 2200K/CRI 80 / 17W - LED 1932 lm ≠ OUTPUT 1419 lm - 2700K/CRI 80 / 17W - LED 2070 lm ≠ OUTPUT 1520 lm - 3000K/CRI 80 / 17W - LED 2139 lm ≠ OUTPUT 1571 lm - 4000K/CRI 80

2200K	2700K	3000K	4000K	
Non Dimmable	Non Dimmable	Non Dimmable	Non Dimmable	
● F017P1AA006	● F017P2AA006	● F017P3AA006	● F017P4AA006	875,00 €
● F017P1AA033	● F017P2AA033	● F017P3AA033	● F017P4AA033	875,00 €
1-10V	1-10V	1-10V	1-10V	
● F017P1AB006	● F017P2AB006	● F017P3AB006	● F017P4AB006	909,00 €
● F017P1AB033	● F017P2AB033	● F017P3AB033	● F017P4AB033	909,00 €
Dali	Dali	Dali	Dali	
● F017P1AD006	● F017P2AD006	● F017P3AD006	● F017P4AD006	931,00 €
● F017P1AD033	● F017P2AD033	● F017P3AD033	● F017P4AD033	931,00 €

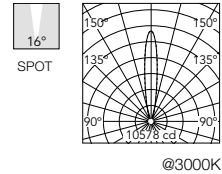

Beam Angle: 16°

h(m)	E(lx)	D(m)
1	10578	0.27
2	2644	0.55
3	1175	0.82
4	661	1.09
5	423	1.37

Optic Medium 25°

Power Led: 17W - LED 1863 lm ≠ OUTPUT 1473 lm - 2200K/CRI 80 / 17W - LED 1932 lm ≠ OUTPUT 1527 lm - 2700K/CRI 80 / 17W - LED 2070 lm ≠ OUTPUT 1636 lm - 3000K/CRI 80 / 17W - LED 2139 lm ≠ OUTPUT 1691 lm - 4000K/CRI 80

2200K	2700K	3000K	4000K	
Non Dimmable	Non Dimmable	Non Dimmable	Non Dimmable	
● F017P1BA006	● F017P2BA006	● F017P3BA006	● F017P4BA006	875,00 €
● F017P1BA033	● F017P2BA033	● F017P3BA033	● F017P4BA033	875,00 €
1-10V	1-10V	1-10V	1-10V	
● F017P1BB006	● F017P2BB006	● F017P3BB006	● F017P4BB006	909,00 €
● F017P1BB033	● F017P2BB033	● F017P3BB033	● F017P4BB033	909,00 €
Dali	Dali	Dali	Dali	
● F017P1BD006	● F017P2BD006	● F017P3BD006	● F017P4BD006	931,00 €
● F017P1BD033	● F017P2BD033	● F017P3BD033	● F017P4BD033	931,00 €

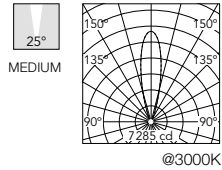

Beam Angle: 25°

h(m)	E(lx)	D(m)
1	7285	0.44
2	1821	0.88
3	809	1.32
4	455	1.76
5	291	2.20

Optic Flood 46°

Power Led: 17W - LED 1863 lm ≠ OUTPUT 1283 lm - 2200K/CRI 80 / 17W - LED 1932 lm ≠ OUTPUT 1330 lm - 2700K/CRI 80 / 17W - LED 2070 lm ≠ OUTPUT 1425 lm - 3000K/CRI 80 / 17W - LED 2139 lm ≠ OUTPUT 1473 lm - 4000K/CRI 80

2200K	2700K	3000K	4000K	
Non Dimmable	Non Dimmable	Non Dimmable	Non Dimmable	
● F017P1CA006	● F017P2CA006	● F017P3CA006	● F017P4CA006	875,00 €
● F017P1CA033	● F017P2CA033	● F017P3CA033	● F017P4CA033	875,00 €
1-10V	1-10V	1-10V	1-10V	
● F017P1CB006	● F017P2CB006	● F017P3CB006	● F017P4CB006	909,00 €
● F017P1CB033	● F017P2CB033	● F017P3CB033	● F017P4CB033	909,00 €
Dali	Dali	Dali	Dali	
● F017P1CD006	● F017P2CD006	● F017P3CD006	● F017P4CD006	931,00 €
● F017P1CD033	● F017P2CD033	● F017P3CD033	● F017P4CD033	931,00 €

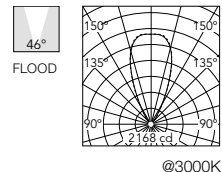

Beam Angle: 46°

h(m)	E(lx)	D(m)
1	2158	0.85
2	539	1.71
3	240	2.56
4	135	3.42
5	86	4.27

Optic Elliptical 12° x 50°

Power Led: 17W - LED 1863 lm ≠ OUTPUT 1286 lm - 2200K/CRI 80 / 17W - LED 1932 lm ≠ OUTPUT 1334 lm - 2700K/CRI 80 / 17W - LED 2070 lm ≠ OUTPUT 1429 lm - 3000K/CRI 80 / 17W - LED 2139 lm ≠ OUTPUT 1477 lm - 4000K/CRI 80

2200K	2700K	3000K	4000K	
Non Dimmable	Non Dimmable	Non Dimmable	Non Dimmable	
● F017P1DA006	● F017P2DA006	● F017P3DA006	● F017P4DA006	875,00 €
● F017P1DA033	● F017P2DA033	● F017P3DA033	● F017P4DA033	875,00 €
1-10V	1-10V	1-10V	1-10V	
● F017P1DB006	● F017P2DB006	● F017P3DB006	● F017P4DB006	909,00 €
● F017P1DB033	● F017P2DB033	● F017P3DB033	● F017P4DB033	909,00 €
Dali	Dali	Dali	Dali	
● F017P1DD006	● F017P2DD006	● F017P3DD006	● F017P4DD006	931,00 €
● F017P1DD033	● F017P2DD033	● F017P3DD033	● F017P4DD033	931,00 €

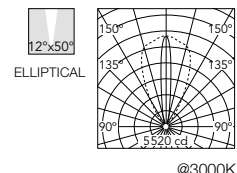

Beam Angle: 12°

h(m)	E(lx)	D(m)
1	5519	0.22
2	1380	0.44
3	613	0.66
4	345	0.87
5	221	1.09

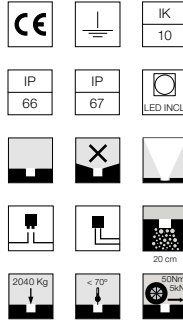
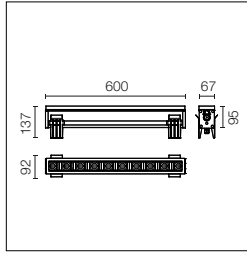

Source LED haute puissance incluse et optique en retrait équipée d'une grille à lamelles anti-éblouissement. Alimentation 220-240 V ON-OFF et variable 1-10 V et DALI. Le coffrage d'installation obligatoire doit être commandé séparément. Précâblé avec les connecteurs rapides H₂O Stop prise/fiche inclus. ACT (Anti Corrosion Treatment) sur demande.

High-power LED source included and rear lenses equipped with anti-glare diffuser grille. 1-10V or DALI on-off and dimmable 220-240V power supply. Compulsory installation box to be ordered separately. Pre-wired with H₂O Stop quick connectors, plug/socket included. ACT (Anti-Corrosion Treatment) upon request.

Optic Spot 16°

Power Led: 17W - LED 1863 lm ≠ OUTPUT 1003 lm - 2200K/CRI 80 / 17W - LED 1932 lm ≠ OUTPUT 1040 lm - 2700K/CRI 80 / 17W - LED 2070 lm ≠ OUTPUT 1115 lm - 3000K/CRI 80 / 17W - LED 2139 lm ≠ OUTPUT 1152 lm - 4000K/CRI 80

2200K

- Non Dimmable
- F017P1HA006
 - F017P1HA033
 - 1-10V
 - F017P1HB006
 - F017P1HB033
 - Dali
 - F017P1HD006
 - F017P1HD033

2700K

- Non Dimmable
- F017P2HA006
 - F017P2HA033
 - 1-10V
 - F017P2HB006
 - F017P2HB033
 - Dali
 - F017P2HD006
 - F017P2HD033

3000K

- Non Dimmable
- F017P3HA006
 - F017P3HA033
 - 1-10V
 - F017P3HB006
 - F017P3HB033
 - Dali
 - F017P3HD006
 - F017P3HD033

4000K

- Non Dimmable
- F017P4HA006 885,00 €
 - F017P4HA033 885,00 €
 - 1-10V
 - F017P4HB006 919,00 €
 - F017P4HB033 919,00 €
 - Dali
 - F017P4HD006 941,00 €
 - F017P4HD033 941,00 €

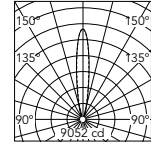

Beam Angle: 16°

h(m)	E(lx)	D(m)
1	9052	0.28
2	2263	0.56
3	1006	0.83
4	566	1.11
5	362	1.39

@3000K

Optic Medium 25°

Power Led: 17W - LED 1863 lm ≠ OUTPUT 1063 lm - 2200K/CRI 80 / 17W - LED 1932 lm ≠ OUTPUT 1102 lm - 2700K/CRI 80 / 17W - LED 2070 lm ≠ OUTPUT 1181 lm - 3000K/CRI 80 / 17W - LED 2139 lm ≠ OUTPUT 1220 lm - 4000K/CRI 80

2200K

- Non Dimmable
- F017P1JA006
 - F017P1JA033
 - 1-10V
 - F017P1JB006
 - F017P1JB033
 - Dali
 - F017P1JD006
 - F017P1JD033

2700K

- Non Dimmable
- F017P2JA006
 - F017P2JA033
 - 1-10V
 - F017P2JB006
 - F017P2JB033
 - Dali
 - F017P2JD006
 - F017P2JD033

3000K

- Non Dimmable
- F017P3JA006
 - F017P3JA033
 - 1-10V
 - F017P3JB006
 - F017P3JB033
 - Dali
 - F017P3JD006
 - F017P3JD033

4000K

- Non Dimmable
- F017P4JA006 885,00 €
 - F017P4JA033 885,00 €
 - 1-10V
 - F017P4JB006 919,00 €
 - F017P4JB033 919,00 €
 - Dali
 - F017P4JD006 941,00 €
 - F017P4JD033 941,00 €

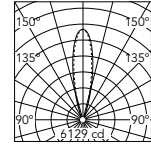

Beam Angle: 25°

h(m)	E(lx)	D(m)
1	6129	0.44
2	1532	0.87
3	681	1.31
4	383	1.74
5	245	2.18

@3000K

Optic Flood 39°

Power Led: 17W - LED 1863 lm ≠ OUTPUT 820 lm - 2200K/CRI 80 / 17W - LED 1932 lm ≠ OUTPUT 850 lm - 2700K/CRI 80 / 17W - LED 2070 lm ≠ OUTPUT 911 lm - 3000K/CRI 80 / 17W - LED 2139 lm ≠ OUTPUT 944 lm - 4000K/CRI 80

2200K

- Non Dimmable
- F017P1KA006
 - F017P1KA033
 - 1-10V
 - F017P1KB006
 - F017P1KB033
 - Dali
 - F017P1KD006
 - F017P1KD033

2700K

- Non Dimmable
- F017P2KA006
 - F017P2KA033
 - 1-10V
 - F017P2KB006
 - F017P2KB033
 - Dali
 - F017P2KD006
 - F017P2KD033

3000K

- Non Dimmable
- F017P3KA006
 - F017P3KA033
 - 1-10V
 - F017P3KB006
 - F017P3KB033
 - Dali
 - F017P3KD006
 - F017P3KD033

4000K

- Non Dimmable
- F017P4KA006 885,00 €
 - F017P4KA033 885,00 €
 - 1-10V
 - F017P4KB006 919,00 €
 - F017P4KB033 919,00 €
 - Dali
 - F017P4KD006 941,00 €
 - F017P4KD033 941,00 €

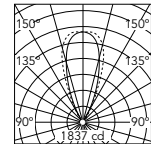

Beam Angle: 39°

h(m)	E(lx)	D(m)
1	1832	0.71
2	458	1.43
3	204	2.14
4	115	2.86
5	73	3.57

@3000K

Optic Elliptical 13° x 40°

Power Led: 17W - LED 1863 lm ≠ OUTPUT 820 lm - 2200K/CRI 80 / 17W - LED 1932 lm ≠ OUTPUT 850 lm - 2700K/CRI 80 / 17W - LED 2070 lm ≠ OUTPUT 911 lm - 3000K/CRI 80 / 17W - LED 2139 lm ≠ OUTPUT 941 lm - 4000K/CRI 80

2200K

- Non Dimmable
- F017P1LA006
 - F017P1LA033
 - 1-10V
 - F017P1LB006
 - F017P1LB033
 - Dali
 - F017P1LD006
 - F017P1LD033

2700K

- Non Dimmable
- F017P2LA006
 - F017P2LA033
 - 1-10V
 - F017P2LB006
 - F017P2LB033
 - Dali
 - F017P2LD006
 - F017P2LD033

3000K

- Non Dimmable
- F017P3LA006
 - F017P3LA033
 - 1-10V
 - F017P3LB006
 - F017P3LB033
 - Dali
 - F017P3LD006
 - F017P3LD033

4000K

- Non Dimmable
- F017P4LA006 885,00 €
 - F017P4LA033 885,00 €
 - 1-10V
 - F017P4LB006 919,00 €
 - F017P4LB033 919,00 €
 - Dali
 - F017P4LD006 941,00 €
 - F017P4LD033 941,00 €

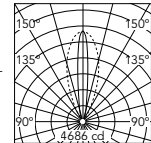

Beam Angle: 13°

h(m)	E(lx)	D(m)
1	4686	0.22
2	1172	0.44
3	521	0.67
4	293	0.89
5	187	1.11

@3000K

Ingraze Adjustable Frameless + Asymmetric Louvre L 600

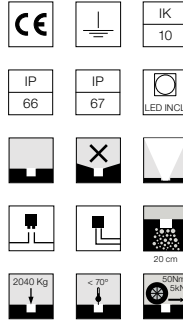
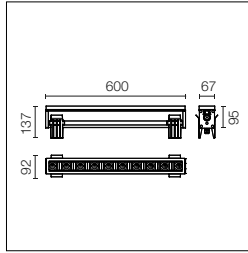

Source LED haute puissance incluse et optique en retrait équipée d'une grille à lamelles asymétrique anti-éblouissement. Alimentation 220-240 V ON-OFF et variable 1-10 V et DALI.
Le coffrage d'installation obligatoire doit être commandé séparément. Précâblé avec les connecteurs rapides H₂O Stop prise/fiche inclus. ACT (Anti Corrosion Treatment) sur demande.

High-power LED source included and rear lenses equipped with anti-glare asymmetrical diffuser grille. 1-10V or DALI on-off and dimmable 220-240V power supply. Compulsory installation box to be ordered separately. Pre-wired with H₂O Stop quick connectors, plug/socket included. ACT (Anti-Corrosion Treatment) upon request.

Optic Spot 15°

Power Led: 17W - LED 1863 lm ≠ OUTPUT 477 lm - 2200K/CRI 80 / 17W - LED 1932 lm ≠ OUTPUT 495 lm - 2700K/CRI 80 / 17W - LED 2070 lm ≠ OUTPUT 530 lm - 3000K/CRI 80 / 17W - LED 2139 lm ≠ OUTPUT 548 lm - 4000K/CRI 80

2200K	2700K	3000K	4000K	
Non Dimmable	Non Dimmable	Non Dimmable	Non Dimmable	
● F017P1QA006	● F017P2QA006	● F017P3QA006	● F017P4QA006	885,00 €
● F017P1QA033	● F017P2QA033	● F017P3QA033	● F017P4QA033	885,00 €
1-10V	1-10V	1-10V	1-10V	
● F017P1QB006	● F017P2QB006	● F017P3QB006	● F017P4QB006	919,00 €
● F017P1QB033	● F017P2QB033	● F017P3QB033	● F017P4QB033	919,00 €
Dali	Dali	Dali	Dali	
● F017P1QD006	● F017P2QD006	● F017P3QD006	● F017P4QD006	941,00 €
● F017P1QD033	● F017P2QD033	● F017P3QD033	● F017P4QD033	941,00 €

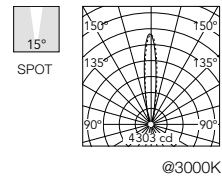

Beam Angle: 15°

h(m)	E(lx)	D(m)
1	4300	0.25
2	1075	0.51
3	478	0.76
4	269	1.02
5	172	1.27

Optic Medium 25°

Power Led: 17W - LED 1863 lm ≠ OUTPUT 505 lm - 2200K/CRI 80 / 17W - LED 1932 lm ≠ OUTPUT 523 lm - 2700K/CRI 80 / 17W - LED 2070 lm ≠ OUTPUT 561 lm - 3000K/CRI 80 / 17W - LED 2139 lm ≠ OUTPUT 579 lm - 4000K/CRI 80

2200K	2700K	3000K	4000K	
Non Dimmable	Non Dimmable	Non Dimmable	Non Dimmable	
● F017P1RA006	● F017P2RA006	● F017P3RA006	● F017P4RA006	885,00 €
● F017P1RA033	● F017P2RA033	● F017P3RA033	● F017P4RA033	885,00 €
1-10V	1-10V	1-10V	1-10V	
● F017P1RB006	● F017P2RB006	● F017P3RB006	● F017P4RB006	919,00 €
● F017P1RB033	● F017P2RB033	● F017P3RB033	● F017P4RB033	919,00 €
Dali	Dali	Dali	Dali	
● F017P1RD006	● F017P2RD006	● F017P3RD006	● F017P4RD006	941,00 €
● F017P1RD033	● F017P2RD033	● F017P3RD033	● F017P4RD033	941,00 €

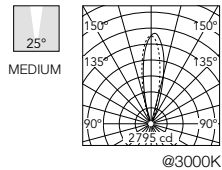

Beam Angle: 25°

h(m)	E(lx)	D(m)
1	2790	0.45
2	698	0.89
3	310	1.34
4	174	1.78
5	112	2.23

Optic Flood 42°

Power Led: 17W - LED 1863 lm ≠ OUTPUT 404 lm - 2200K/CRI 80 / 17W - LED 1932 lm ≠ OUTPUT 419 lm - 2700K/CRI 80 / 17W - LED 2070 lm ≠ OUTPUT 449 lm - 3000K/CRI 80 / 17W - LED 2139 lm ≠ OUTPUT 464 lm - 4000K/CRI 80

2200K	2700K	3000K	4000K	
Non Dimmable	Non Dimmable	Non Dimmable	Non Dimmable	
● F017P1SA006	● F017P2SA006	● F017P3SA006	● F017P4SA006	885,00 €
● F017P1SA033	● F017P2SA033	● F017P3SA033	● F017P4SA033	885,00 €
1-10V	1-10V	1-10V	1-10V	
● F017P1SB006	● F017P2SB006	● F017P3SB006	● F017P4SB006	919,00 €
● F017P1SB033	● F017P2SB033	● F017P3SB033	● F017P4SB033	919,00 €
Dali	Dali	Dali	Dali	
● F017P1SD006	● F017P2SD006	● F017P3SD006	● F017P4SD006	941,00 €
● F017P1SD033	● F017P2SD033	● F017P3SD033	● F017P4SD033	941,00 €

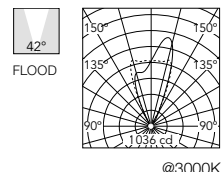

Beam Angle: 42°

h(m)	E(lx)	D(m)
1	983	0.76
2	246	1.51
3	109	2.27
4	61	3.03
5	39	3.78

Optic Elliptical 12° x 40°

Power Led: 17W - LED 1863 lm ≠ OUTPUT 387 lm - 2200K/CRI 80 / 17W - LED 1932 lm ≠ OUTPUT 401 lm - 2700K/CRI 80 / 17W - LED 2070 lm ≠ OUTPUT 430 lm - 3000K/CRI 80 / 17W - LED 2139 lm ≠ OUTPUT 444 lm - 4000K/CRI 80

2200K	2700K	3000K	4000K	
Non Dimmable	Non Dimmable	Non Dimmable	Non Dimmable	
● F017P1TA006	● F017P2TA006	● F017P3TA006	● F017P4TA006	885,00 €
● F017P1TA033	● F017P2TA033	● F017P3TA033	● F017P4TA033	885,00 €
1-10V	1-10V	1-10V	1-10V	
● F017P1TB006	● F017P2TB006	● F017P3TB006	● F017P4TB006	919,00 €
● F017P1TB033	● F017P2TB033	● F017P3TB033	● F017P4TB033	919,00 €
Dali	Dali	Dali	Dali	
● F017P1TD006	● F017P2TD006	● F017P3TD006	● F017P4TD006	941,00 €
● F017P1TD033	● F017P2TD033	● F017P3TD033	● F017P4TD033	941,00 €

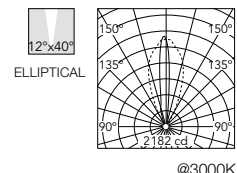

Beam Angle: 12°

h(m)	E(lx)	D(m)
1	2181	0.21
2	545	0.42
3	242	0.62
4	136	0.83
5	87	1.04

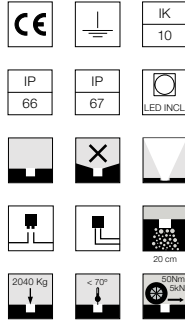
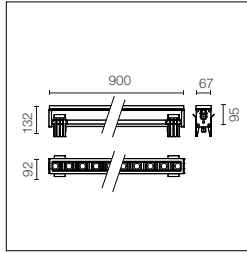

Source LED haute puissance incluse et optique en retrait.
Alimentation 220-240 V ON-OFF et variable 1-10 V et DALI.
Le coffrage d'installation obligatoire doit être commandé séparément.
Précâblé avec les connecteurs rapides H₂O Stop prise/fiche inclus.
ACT (Anti Corrosion Treatment) sur demande.

High-power LED source included and rear lenses. 1-10V or DALI on-off and dimmable 220-240V power supply.
Compulsory installation box to be ordered separately.
Pre-wired with H₂O Stop quick connectors, plug/socket included.
ACT (Anti-Corrosion Treatment) upon request.

Optic Spot 16°

Power Led: 26W - LED 2795 lm ≠ OUTPUT 2052 lm - 2200K/CRI 80 / 26W - LED 2898 lm ≠ OUTPUT 2128 lm - 2700K/CRI 80 / 26W - LED 3105 lm ≠ OUTPUT 2280 lm - 3000K/CRI 80 / 26W - LED 3209 lm ≠ OUTPUT 2536 lm - 4000K/CRI 80

2200K	2700K	3000K	4000K	
Non Dimmable	Non Dimmable	Non Dimmable	Non Dimmable	
● F017Q1AA006	● F017Q2AA006	● F017Q3AA006	● F017Q4AA006	997,00 €
● F017Q1AA033	● F017Q2AA033	● F017Q3AA033	● F017Q4AA033	997,00 €
1-10V	1-10V	1-10V	1-10V	
● F017Q1AB006	● F017Q2AB006	● F017Q3AB006	● F017Q4AB006	1.037,00 €
● F017Q1AB033	● F017Q2AB033	● F017Q3AB033	● F017Q4AB033	1.037,00 €
Dali	Dali	Dali	Dali	
● F017Q1AD006	● F017Q2AD006	● F017Q3AD006	● F017Q4AD006	1.062,00 €
● F017Q1AD033	● F017Q2AD033	● F017Q3AD033	● F017Q4AD033	1.062,00 €

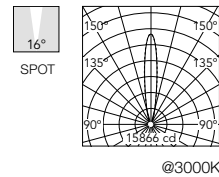

Optic Medium 25°

Power Led: 26W - LED 2795 lm ≠ OUTPUT 2209 lm - 2200K/CRI 80 / 26W - LED 2898 lm ≠ OUTPUT 2291 lm - 2700K/CRI 80 / 26W - LED 3105 lm ≠ OUTPUT 2454 lm - 3000K/CRI 80 / 26W - LED 3209 lm ≠ OUTPUT 2536 lm - 4000K/CRI 80

2200K	2700K	3000K	4000K	
Non Dimmable	Non Dimmable	Non Dimmable	Non Dimmable	
● F017Q1BA006	● F017Q2BA006	● F017Q3BA006	● F017Q4BA006	997,00 €
● F017Q1BA033	● F017Q2BA033	● F017Q3BA033	● F017Q4BA033	997,00 €
1-10V	1-10V	1-10V	1-10V	
● F017Q1BB006	● F017Q2BB006	● F017Q3BB006	● F017Q4BB006	1.037,00 €
● F017Q1BB033	● F017Q2BB033	● F017Q3BB033	● F017Q4BB033	1.037,00 €
Dali	Dali	Dali	Dali	
● F017Q1BD006	● F017Q2BD006	● F017Q3BD006	● F017Q4BD006	1.062,00 €
● F017Q1BD033	● F017Q2BD033	● F017Q3BD033	● F017Q4BD033	1.062,00 €

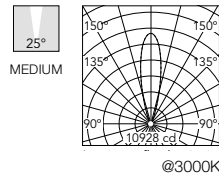

Optic Flood 46°

Power Led: 26W - LED 2795 lm ≠ OUTPUT 1924 lm - 2200K/CRI 80 / 26W - LED 2898 lm ≠ OUTPUT 1995 lm - 2700K/CRI 80 / 26W - LED 3105 lm ≠ OUTPUT 2138 lm - 3000K/CRI 80 / 26W - LED 3209 lm ≠ OUTPUT 2209 lm - 4000K/CRI 80

2200K	2700K	3000K	4000K	
Non Dimmable	Non Dimmable	Non Dimmable	Non Dimmable	
● F017Q1CA006	● F017Q2CA006	● F017Q3CA006	● F017Q4CA006	997,00 €
● F017Q1CA033	● F017Q2CA033	● F017Q3CA033	● F017Q4CA033	997,00 €
1-10V	1-10V	1-10V	1-10V	
● F017Q1CB006	● F017Q2CB006	● F017Q3CB006	● F017Q4CB006	1.037,00 €
● F017Q1CB033	● F017Q2CB033	● F017Q3CB033	● F017Q4CB033	1.037,00 €
Dali	Dali	Dali	Dali	
● F017Q1CD006	● F017Q2CD006	● F017Q3CD006	● F017Q4CD006	1.062,00 €
● F017Q1CD033	● F017Q2CD033	● F017Q3CD033	● F017Q4CD033	1.062,00 €

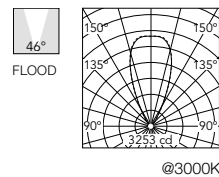

Optic Elliptical 12° x 50°

Power Led: 26W - LED 2795 lm ≠ OUTPUT 1929 lm - 2200K/CRI 80 / 26W - LED 2898 lm ≠ OUTPUT 2001 lm - 2700K/CRI 80 / 26W - LED 3105 lm ≠ OUTPUT 2144 lm - 3000K/CRI 80 / 26W - LED 3209 lm ≠ OUTPUT 2215 lm - 4000K/CRI 80

2200K	2700K	3000K	4000K	
Non Dimmable	Non Dimmable	Non Dimmable	Non Dimmable	
● F017Q1DA006	● F017Q2DA006	● F017Q3DA006	● F017Q4DA006	997,00 €
● F017Q1DA033	● F017Q2DA033	● F017Q3DA033	● F017Q4DA033	997,00 €
1-10V	1-10V	1-10V	1-10V	
● F017Q1DB006	● F017Q2DB006	● F017Q3DB006	● F017Q4DB006	1.037,00 €
● F017Q1DB033	● F017Q2DB033	● F017Q3DB033	● F017Q4DB033	1.037,00 €
Dali	Dali	Dali	Dali	
● F017Q1DD006	● F017Q2DD006	● F017Q3DD006	● F017Q4DD006	1.062,00 €
● F017Q1DD033	● F017Q2DD033	● F017Q3DD033	● F017Q4DD033	1.062,00 €

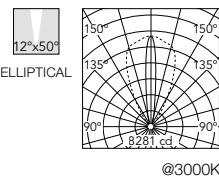

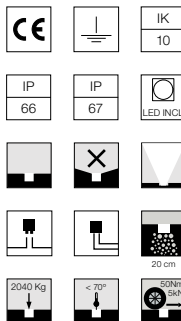
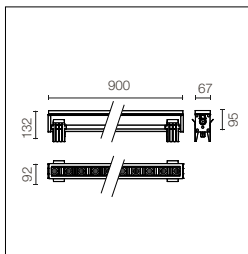

Source LED haute puissance incluse et optique en retrait équipée d'une grille à lamelles anti-éblouissement. Alimentation 220-240 V ON-OFF et variable 1-10 V et DALI. Le coffrage d'installation obligatoire doit être commandé séparément. Précâblé avec les connecteurs rapides H₂O Stop prise/fiche inclus. ACT (Anti Corrosion Treatment) sur demande.

High-power LED source included and rear lenses equipped with anti-glare diffuser grille. 1-10V or DALI on-off and dimmable 220-240V power supply. Compulsory installation box to be ordered separately. Pre-wired with H₂O Stop quick connectors, plug/socket included. ACT (Anti-Corrosion Treatment) upon request.

Optic Spot 16°

Power Led: 26W - LED 2795 lm ≠ OUTPUT 1505 lm - 2200K/CRI 80 / 26W - LED 2898 lm ≠ OUTPUT 1560 lm - 2700K/CRI 80 / 26W - LED 3105 lm ≠ OUTPUT 1672 lm - 3000K/CRI 80 / 26W - LED 3209 lm ≠ OUTPUT 1728 lm - 4000K/CRI 80

2200K	2700K	3000K	4000K	
Non Dimmable	Non Dimmable	Non Dimmable	Non Dimmable	
● F017Q1HA006	● F017Q2HA006	● F017Q3HA006	● F017Q4HA006	1.013,00 €
● F017Q1HA033	● F017Q2HA033	● F017Q3HA033	● F017Q4HA033	1.013,00 €
1-10V	1-10V	1-10V	1-10V	
● F017Q1HB006	● F017Q2HB006	● F017Q3HB006	● F017Q4HB006	1.052,00 €
● F017Q1HB033	● F017Q2HB033	● F017Q3HB033	● F017Q4HB033	1.052,00 €
Dali	Dali	Dali	Dali	
● F017Q1HD006	● F017Q2HD006	● F017Q3HD006	● F017Q4HD006	1.077,00 €
● F017Q1HD033	● F017Q2HD033	● F017Q3HD033	● F017Q4HD033	1.077,00 €

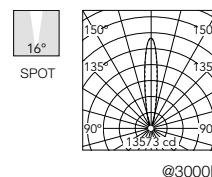

Beam Angle: 16°

h(m)	E(lx)	D(m)
1	13573	0.28
2	3393	0.56
3	1508	0.83
4	848	1.11
5	543	1.39

@3000K

Optic Medium 25°

Power Led: 26W - LED 2795 lm ≠ OUTPUT 1594 lm - 2200K/CRI 80 / 26W - LED 2898 lm ≠ OUTPUT 1653 lm - 2700K/CRI 80 / 26W - LED 3105 lm ≠ OUTPUT 1771 lm - 3000K/CRI 80 / 26W - LED 3209 lm ≠ OUTPUT 1830 lm - 4000K/CRI 80

2200K	2700K	3000K	4000K	
Non Dimmable	Non Dimmable	Non Dimmable	Non Dimmable	
● F017Q1JA006	● F017Q2JA006	● F017Q3JA006	● F017Q4JA006	1.013,00 €
● F017Q1JA033	● F017Q2JA033	● F017Q3JA033	● F017Q4JA033	1.013,00 €
1-10V	1-10V	1-10V	1-10V	
● F017Q1JB006	● F017Q2JB006	● F017Q3JB006	● F017Q4JB006	1.052,00 €
● F017Q1JB033	● F017Q2JB033	● F017Q3JB033	● F017Q4JB033	1.052,00 €
Dali	Dali	Dali	Dali	
● F017Q1JD006	● F017Q2JD006	● F017Q3JD006	● F017Q4JD006	1.077,00 €
● F017Q1JD033	● F017Q2JD033	● F017Q3JD033	● F017Q4JD033	1.077,00 €

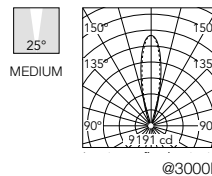

Beam Angle: 25°

h(m)	E(lx)	D(m)
1	9191	0.44
2	2298	0.87
3	1021	1.31
4	574	1.74
5	368	2.18

@3000K

Optic Flood 39°

Power Led: 26W - LED 2795 lm ≠ OUTPUT 1233 lm - 2200K/CRI 80 / 26W - LED 2898 lm ≠ OUTPUT 1278 lm - 2700K/CRI 80 / 26W - LED 3105 lm ≠ OUTPUT 1370 lm - 3000K/CRI 80 / 26W - LED 3209 lm ≠ OUTPUT 1415 lm - 4000K/CRI 80

2200K	2700K	3000K	4000K	
Non Dimmable	Non Dimmable	Non Dimmable	Non Dimmable	
● F017Q1KA006	● F017Q2KA006	● F017Q3KA006	● F017Q4KA006	1.013,00 €
● F017Q1KA033	● F017Q2KA033	● F017Q3KA033	● F017Q4KA033	1.013,00 €
1-10V	1-10V	1-10V	1-10V	
● F017Q1KB006	● F017Q2KB006	● F017Q3KB006	● F017Q4KB006	1.052,00 €
● F017Q1KB033	● F017Q2KB033	● F017Q3KB033	● F017Q4KB033	1.052,00 €
Dali	Dali	Dali	Dali	
● F017Q1KD006	● F017Q2KD006	● F017Q3KD006	● F017Q4KD006	1.077,00 €
● F017Q1KD033	● F017Q2KD033	● F017Q3KD033	● F017Q4KD033	1.077,00 €

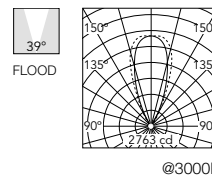

Beam Angle: 39°

h(m)	E(lx)	D(m)
1	2755	0.71
2	689	1.43
3	306	2.14
4	172	2.86
5	110	3.57

@3000K

Optic Elliptical 13° x 40°

Power Led: 26W - LED 2795 lm ≠ OUTPUT 1229 lm - 2200K/CRI 80 / 26W - LED 2898 lm ≠ OUTPUT 1275 lm - 2700K/CRI 80 / 26W - LED 3105 lm ≠ OUTPUT 1366 lm - 3000K/CRI 80 / 26W - LED 3209 lm ≠ OUTPUT 1411 lm - 4000K/CRI 80

2200K	2700K	3000K	4000K	
Non Dimmable	Non Dimmable	Non Dimmable	Non Dimmable	
● F017Q1LA006	● F017Q2LA006	● F017Q3LA006	● F017Q4LA006	1.013,00 €
● F017Q1LA033	● F017Q2LA033	● F017Q3LA033	● F017Q4LA033	1.013,00 €
1-10V	1-10V	1-10V	1-10V	
● F017Q1LB006	● F017Q2LB006	● F017Q3LB006	● F017Q4LB006	1.052,00 €
● F017Q1LB033	● F017Q2LB033	● F017Q3LB033	● F017Q4LB033	1.052,00 €
Dali	Dali	Dali	Dali	
● F017Q1LD006	● F017Q2LD006	● F017Q3LD006	● F017Q4LD006	1.077,00 €
● F017Q1LD033	● F017Q2LD033	● F017Q3LD033	● F017Q4LD033	1.077,00 €

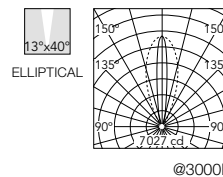

Beam Angle: 13°

h(m)	E(lx)	D(m)
1	7027	0.22
2	1757	0.44
3	781	0.67
4	439	0.89
5	281	1.11

@3000K

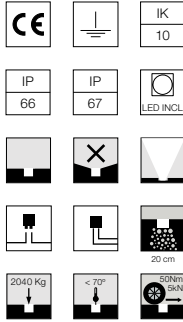
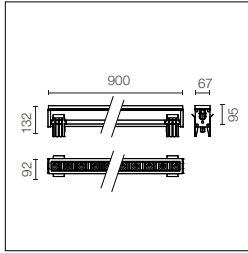

Source LED haute puissance incluse et optique en retrait équipée d'une grille à lamelles asymétrique anti-éblouissement. Alimentation 220-240 V ON-OFF et variable 1-10 V et DALI.
Le coffrage d'installation obligatoire doit être commandé séparément. Précâblé avec les connecteurs rapides H₂O Stop prise/fiche inclus. ACT (Anti Corrosion Treatment) sur demande.

High-power LED source included and rear lenses equipped with anti-glare asymmetrical diffuser grille. 1-10V or DALI on-off and dimmable 220-240V power supply. Compulsory installation box to be ordered separately. Pre-wired with H₂O Stop quick connectors, plug/socket included. ACT (Anti-Corrosion Treatment) upon request.

Optic Spot 15°

Power Led: 26W - LED 2795 lm ≠ OUTPUT 715 lm - 2200K/CRI 80 / 26W - LED 2898 lm ≠ OUTPUT 742 lm - 2700K/CRI 80 / 26W - LED 3105 lm ≠ OUTPUT 795 lm - 3000K/CRI 80 / 26W - LED 3209 lm ≠ OUTPUT 821 lm - 4000K/CRI 80

2200K	2700K	3000K	4000K	
Non Dimmable	Non Dimmable	Non Dimmable	Non Dimmable	
● F017Q1QA006	● F017Q2QA006	● F017Q3QA006	● F017Q4QA006	1.013,00 €
● F017Q1QA033	● F017Q2QA033	● F017Q3QA033	● F017Q4QA033	1.013,00 €
1-10V	1-10V	1-10V	1-10V	
● F017Q1QB006	● F017Q2QB006	● F017Q3QB006	● F017Q4QB006	1.052,00 €
● F017Q1QB033	● F017Q2QB033	● F017Q3QB033	● F017Q4QB033	1.052,00 €
Dali	Dali	Dali	Dali	
● F017Q1QD006	● F017Q2QD006	● F017Q3QD006	● F017Q4QD006	1.077,00 €
● F017Q1QD033	● F017Q2QD033	● F017Q3QD033	● F017Q4QD033	1.077,00 €

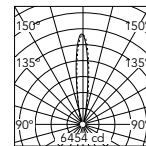

Beam Angle: 15°

h(m)	E(lx)	D(m)
1	6451	0.25
2	1613	0.51
3	717	0.76
4	403	1.02
5	258	1.27

@3000K

Optic Medium 25°

Power Led: 26W - LED 2795 lm ≠ OUTPUT 757 lm - 2200K/CRI 80 / 26W - LED 2898 lm ≠ OUTPUT 785 lm - 2700K/CRI 80 / 26W - LED 3105 lm ≠ OUTPUT 841 lm - 3000K/CRI 80 / 26W - LED 3209 lm ≠ OUTPUT 869 lm - 4000K/CRI 80

2200K	2700K	3000K	4000K	
Non Dimmable	Non Dimmable	Non Dimmable	Non Dimmable	
● F017Q1RA006	● F017Q2RA006	● F017Q3RA006	● F017Q4RA006	1.013,00 €
● F017Q1RA033	● F017Q2RA033	● F017Q3RA033	● F017Q4RA033	1.013,00 €
1-10V	1-10V	1-10V	1-10V	
● F017Q1RB006	● F017Q2RB006	● F017Q3RB006	● F017Q4RB006	1.052,00 €
● F017Q1RB033	● F017Q2RB033	● F017Q3RB033	● F017Q4RB033	1.052,00 €
Dali	Dali	Dali	Dali	
● F017Q1RD006	● F017Q2RD006	● F017Q3RD006	● F017Q4RD006	1.077,00 €
● F017Q1RD033	● F017Q2RD033	● F017Q3RD033	● F017Q4RD033	1.077,00 €

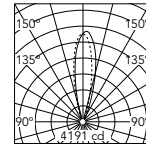

Beam Angle: 25°

h(m)	E(lx)	D(m)
1	4183	0.45
2	1046	0.89
3	465	1.34
4	261	1.78
5	167	2.23

@3000K

Optic Flood 42°

Power Led: 26W - LED 2795 lm ≠ OUTPUT 606 lm - 2200K/CRI 80 / 26W - LED 2898 lm ≠ OUTPUT 628 lm - 2700K/CRI 80 / 26W - LED 3105 lm ≠ OUTPUT 673 lm - 3000K/CRI 80 / 26W - LED 3209 lm ≠ OUTPUT 696 lm - 4000K/CRI 80

2200K	2700K	3000K	4000K	
Non Dimmable	Non Dimmable	Non Dimmable	Non Dimmable	
● F017Q1SA006	● F017Q2SA006	● F017Q3SA006	● F017Q4SA006	1.013,00 €
● F017Q1SA033	● F017Q2SA033	● F017Q3SA033	● F017Q4SA033	1.013,00 €
1-10V	1-10V	1-10V	1-10V	
● F017Q1SB006	● F017Q2SB006	● F017Q3SB006	● F017Q4SB006	1.052,00 €
● F017Q1SB033	● F017Q2SB033	● F017Q3SB033	● F017Q4SB033	1.052,00 €
Dali	Dali	Dali	Dali	
● F017Q1SD006	● F017Q2SD006	● F017Q3SD006	● F017Q4SD006	1.077,00 €
● F017Q1SD033	● F017Q2SD033	● F017Q3SD033	● F017Q4SD033	1.077,00 €

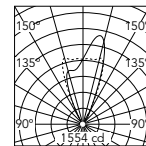

Beam Angle: 42°

h(m)	E(lx)	D(m)
1	1474	0.76
2	368	1.51
3	164	2.27
4	92	3.03
5	59	3.78

@3000K

Optic Elliptical 12° x 40°

Power Led: 26W - LED 2795 lm ≠ OUTPUT 580 lm - 2200K/CRI 80 / 26W - LED 2898 lm ≠ OUTPUT 602 lm - 2700K/CRI 80 / 26W - LED 3105 lm ≠ OUTPUT 645 lm - 3000K/CRI 80 / 26W - LED 3209 lm ≠ OUTPUT 666 lm - 4000K/CRI 80

2200K	2700K	3000K	4000K	
Non Dimmable	Non Dimmable	Non Dimmable	Non Dimmable	
● F017Q1TA006	● F017Q2TA006	● F017Q3TA006	● F017Q4TA006	1.013,00 €
● F017Q1TA033	● F017Q2TA033	● F017Q3TA033	● F017Q4TA033	1.013,00 €
1-10V	1-10V	1-10V	1-10V	
● F017Q1TB006	● F017Q2TB006	● F017Q3TB006	● F017Q4TB006	1.052,00 €
● F017Q1TB033	● F017Q2TB033	● F017Q3TB033	● F017Q4TB033	1.052,00 €
Dali	Dali	Dali	Dali	
● F017Q1TD006	● F017Q2TD006	● F017Q3TD006	● F017Q4TD006	1.077,00 €
● F017Q1TD033	● F017Q2TD033	● F017Q3TD033	● F017Q4TD033	1.077,00 €

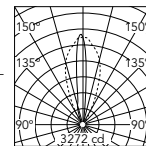

Beam Angle: 12°

h(m)	E(lx)	D(m)
1	3271	0.21
2	818	0.42
3	363	0.62
4	204	0.83
5	131	1.04

@3000K

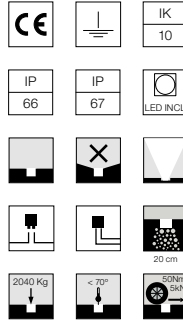
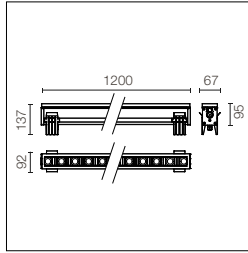

Source LED haute puissance incluse et optique en retrait.
 Alimentation 220-240 V ON-OFF et variable 1-10 V et DALI.
 Le coffrage d'installation obligatoire doit être commandé séparément.
 Précâblé avec les connecteurs rapides H₂O Stop prise/fiche inclus.
 ACT (Anti Corrosion Treatment) sur demande.

High-power LED source included and rear lenses. 1-10V or DALI on-off and dimmable 220-240V power supply.
 Compulsory installation box to be ordered separately.
 Pre-wired with H₂O Stop quick connectors, plug/socket included.
 ACT (Anti-Corrosion Treatment) upon request.

Optic Spot 16°

Power Led: 33,5W - LED 3726 lm ≠ OUTPUT 2736 lm - 2200K/CRI 80 / 33,5W - LED 3864 lm ≠ OUTPUT 2837 lm - 2700K/CRI 80 / 33,5W - LED 4140 lm ≠ OUTPUT 3040 lm - 3000K/CRI 80 / 33,5W - LED 4278 lm ≠ OUTPUT 3141 lm - 4000K/CRI 80

2200K	2700K	3000K	4000K	
Non Dimmable	Non Dimmable	Non Dimmable	Non Dimmable	
● F017R1AA006	● F017R2AA006	● F017R3AA006	● F017R4AA006	1.129,00 €
● F017R1AA033	● F017R2AA033	● F017R3AA033	● F017R4AA033	1.129,00 €
1-10V	1-10V	1-10V	1-10V	
● F017R1AB006	● F017R2AB006	● F017R3AB006	● F017R4AB006	1.172,00 €
● F017R1AB033	● F017R2AB033	● F017R3AB033	● F017R4AB033	1.172,00 €
Dali	Dali	Dali	Dali	
● F017R1AD006	● F017R2AD006	● F017R3AD006	● F017R4AD006	1.205,00 €
● F017R1AD033	● F017R2AD033	● F017R3AD033	● F017R4AD033	1.205,00 €

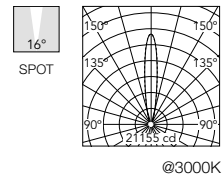

Beam Angle: 16°

h(m)	E(lx)	D(m)
1	21155	0.27
2	5289	0.55
3	2351	0.82
4	1322	1.09
5	846	1.37

Optic Medium 25°

Power Led: 33,5W - LED 3726 lm ≠ OUTPUT 2945 lm - 2200K/CRI 80 / 33,5W - LED 3864 lm ≠ OUTPUT 3054 lm - 2700K/CRI 80 / 33,5W - LED 4140 lm ≠ OUTPUT 3272 lm - 3000K/CRI 80 / 33,5W - LED 4278 lm ≠ OUTPUT 3381 lm - 4000K/CRI 80

2200K	2700K	3000K	4000K	
Non Dimmable	Non Dimmable	Non Dimmable	Non Dimmable	
● F017R1BA006	● F017R2BA006	● F017R3BA006	● F017R4BA006	1.129,00 €
● F017R1BA033	● F017R2BA033	● F017R3BA033	● F017R4BA033	1.129,00 €
1-10V	1-10V	1-10V	1-10V	
● F017R1BB006	● F017R2BB006	● F017R3BB006	● F017R4BB006	1.172,00 €
● F017R1BB033	● F017R2BB033	● F017R3BB033	● F017R4BB033	1.172,00 €
Dali	Dali	Dali	Dali	
● F017R1BD006	● F017R2BD006	● F017R3BD006	● F017R4BD006	1.205,00 €
● F017R1BD033	● F017R2BD033	● F017R3BD033	● F017R4BD033	1.205,00 €

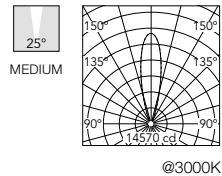

Beam Angle: 25°

h(m)	E(lx)	D(m)
1	14570	0.44
2	3643	0.88
3	1619	1.32
4	911	1.76
5	583	2.20

Optic Flood 46°

Power Led: 33,5W - LED 3726 lm ≠ OUTPUT 2565 lm - 2200K/CRI 80 / 33,5W - LED 3864 lm ≠ OUTPUT 2660 lm - 2700K/CRI 80 / 33,5W - LED 4140 lm ≠ OUTPUT 2850 lm - 3000K/CRI 80 / 33,5W - LED 4278 lm ≠ OUTPUT 2945 lm - 4000K/CRI 80

2200K	2700K	3000K	4000K	
Non Dimmable	Non Dimmable	Non Dimmable	Non Dimmable	
● F017R1CA006	● F017R2CA006	● F017R3CA006	● F017R4CA006	1.129,00 €
● F017R1CA033	● F017R2CA033	● F017R3CA033	● F017R4CA033	1.129,00 €
1-10V	1-10V	1-10V	1-10V	
● F017R1CB006	● F017R2CB006	● F017R3CB006	● F017R4CB006	1.172,00 €
● F017R1CB033	● F017R2CB033	● F017R3CB033	● F017R4CB033	1.172,00 €
Dali	Dali	Dali	Dali	
● F017R1CD006	● F017R2CD006	● F017R3CD006	● F017R4CD006	1.205,00 €
● F017R1CD033	● F017R2CD033	● F017R3CD033	● F017R4CD033	1.205,00 €

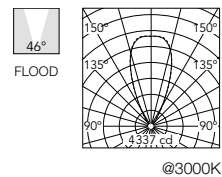

Beam Angle: 46°

h(m)	E(lx)	D(m)
1	4316	0.85
2	1079	1.71
3	480	2.56
4	270	3.42
5	173	4.27

Optic Elliptical 12° x 50°

Power Led: 33,5W - LED 3726 lm ≠ OUTPUT 2572 lm - 2200K/CRI 80 / 33,5W - LED 3864 lm ≠ OUTPUT 2668 lm - 2700K/CRI 80 / 33,5W - LED 4140 lm ≠ OUTPUT 2858 lm - 3000K/CRI 80 / 33,5W - LED 4278 lm ≠ OUTPUT 2953 lm - 4000K/CRI 80

2200K	2700K	3000K	4000K	
Non Dimmable	Non Dimmable	Non Dimmable	Non Dimmable	
● F017R1DA006	● F017R2DA006	● F017R3DA006	● F017R4DA006	1.129,00 €
● F017R1DA033	● F017R2DA033	● F017R3DA033	● F017R4DA033	1.129,00 €
1-10V	1-10V	1-10V	1-10V	
● F017R1DB006	● F017R2DB006	● F017R3DB006	● F017R4DB006	1.172,00 €
● F017R1DB033	● F017R2DB033	● F017R3DB033	● F017R4DB033	1.172,00 €
Dali	Dali	Dali	Dali	
● F017R1DD006	● F017R2DD006	● F017R3DD006	● F017R4DD006	1.205,00 €
● F017R1DD033	● F017R2DD033	● F017R3DD033	● F017R4DD033	1.205,00 €

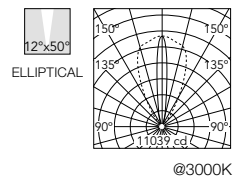

Beam Angle: 12°

h(m)	E(lx)	D(m)
1	11037	0.22
2	2759	0.44
3	1226	0.66
4	690	0.87
5	441	1.09

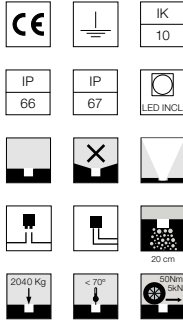
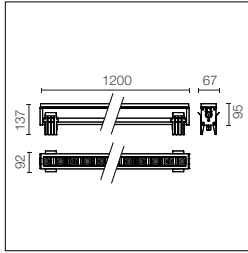

Source LED haute puissance incluse et optique en retrait équipée d'une grille à lamelles anti-éblouissement. Alimentation 220-240 V ON-OFF et variable 1-10 V et DALI.
Le coffrage d'installation obligatoire doit être commandé séparément. Précâblé avec les connecteurs rapides H₂O Stop prise/fiche inclus. ACT (Anti Corrosion Treatment) sur demande.

High-power LED source included and rear lenses equipped with anti-glare diffuser grille. 1-10V or DALI on-off and dimmable 220-240V power supply. Compulsory installation box to be ordered separately. Pre-wired with H₂O Stop quick connectors, plug/socket included. ACT (Anti-Corrosion Treatment) upon request.

Optic Spot 16°

Power Led: 33,5W - LED 3726 lm ≠ OUTPUT 2006 lm - 2200K/CRI 80 / 33,5W - LED 3864 lm ≠ OUTPUT 2080 lm - 2700K/CRI 80 / 33,5W - LED 4140 lm ≠ OUTPUT 2229 lm - 3000K/CRI 80 / 33,5W - LED 4278 lm ≠ OUTPUT 2303 lm - 4000K/CRI 80

2200K	2700K	3000K	4000K	
Non Dimmable	Non Dimmable	Non Dimmable	Non Dimmable	
● F017R1HA006	● F017R2HA006	● F017R3HA006	● F017R4HA006	1.149,00 €
● F017R1HA033	● F017R2HA033	● F017R3HA033	● F017R4HA033	1.149,00 €
1-10V	1-10V	1-10V	1-10V	
● F017R1HB006	● F017R2HB006	● F017R3HB006	● F017R4HB006	1.192,00 €
● F017R1HB033	● F017R2HB033	● F017R3HB033	● F017R4HB033	1.192,00 €
Dali	Dali	Dali	Dali	
● F017R1HD006	● F017R2HD006	● F017R3HD006	● F017R4HD006	1.225,00 €
● F017R1HD033	● F017R2HD033	● F017R3HD033	● F017R4HD033	1.225,00 €

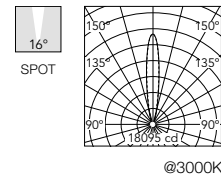

Optic Medium 25°

Power Led: 33,5W - LED 3726 lm ≠ OUTPUT 2125 lm - 2200K/CRI 80 / 33,5W - LED 3864 lm ≠ OUTPUT 2203 lm - 2700K/CRI 80 / 33,5W - LED 4140 lm ≠ OUTPUT 2361 lm - 3000K/CRI 80 / 33,5W - LED 4278 lm ≠ OUTPUT 2439 lm - 4000K/CRI 80

2200K	2700K	3000K	4000K	
Non Dimmable	Non Dimmable	Non Dimmable	Non Dimmable	
● F017R1JA006	● F017R2JA006	● F017R3JA006	● F017R4JA006	1.149,00 €
● F017R1JA033	● F017R2JA033	● F017R3JA033	● F017R4JA033	1.149,00 €
1-10V	1-10V	1-10V	1-10V	
● F017R1JB006	● F017R2JB006	● F017R3JB006	● F017R4JB006	1.192,00 €
● F017R1JB033	● F017R2JB033	● F017R3JB033	● F017R4JB033	1.192,00 €
Dali	Dali	Dali	Dali	
● F017R1JD006	● F017R2JD006	● F017R3JD006	● F017R4JD006	1.225,00 €
● F017R1JD033	● F017R2JD033	● F017R3JD033	● F017R4JD033	1.225,00 €

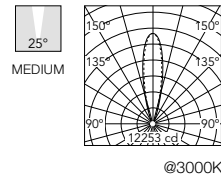

Optic Flood 39°

Power Led: 33,5W - LED 3726 lm ≠ OUTPUT 1643 lm - 2200K/CRI 80 / 33,5W - LED 3864 lm ≠ OUTPUT 1704 lm - 2700K/CRI 80 / 33,5W - LED 4140 lm ≠ OUTPUT 1826 lm - 3000K/CRI 80 / 33,5W - LED 4278 lm ≠ OUTPUT 1887 lm - 4000K/CRI 80

2200K	2700K	3000K	4000K	
Non Dimmable	Non Dimmable	Non Dimmable	Non Dimmable	
● F017R1KA006	● F017R2KA006	● F017R3KA006	● F017R4KA006	1.149,00 €
● F017R1KA033	● F017R2KA033	● F017R3KA033	● F017R4KA033	1.149,00 €
1-10V	1-10V	1-10V	1-10V	
● F017R1KB006	● F017R2KB006	● F017R3KB006	● F017R4KB006	1.192,00 €
● F017R1KB033	● F017R2KB033	● F017R3KB033	● F017R4KB033	1.192,00 €
Dali	Dali	Dali	Dali	
● F017R1KD006	● F017R2KD006	● F017R3KD006	● F017R4KD006	1.225,00 €
● F017R1KD033	● F017R2KD033	● F017R3KD033	● F017R4KD033	1.225,00 €

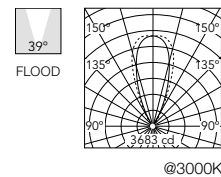

Optic Elliptical 13° x 40°

Power Led: 33,5W - LED 3726 lm ≠ OUTPUT 1639 lm - 2200K/CRI 80 / 33,5W - LED 3864 lm ≠ OUTPUT 1700 lm - 2700K/CRI 80 / 33,5W - LED 4140 lm ≠ OUTPUT 1821 lm - 3000K/CRI 80 / 33,5W - LED 4278 lm ≠ OUTPUT 1882 lm - 4000K/CRI 80

2200K	2700K	3000K	4000K	
Non Dimmable	Non Dimmable	Non Dimmable	Non Dimmable	
● F017R1LA006	● F017R2LA006	● F017R3LA006	● F017R4LA006	1.149,00 €
● F017R1LA033	● F017R2LA033	● F017R3LA033	● F017R4LA033	1.149,00 €
1-10V	1-10V	1-10V	1-10V	
● F017R1LB006	● F017R2LB006	● F017R3LB006	● F017R4LB006	1.192,00 €
● F017R1LB033	● F017R2LB033	● F017R3LB033	● F017R4LB033	1.192,00 €
Dali	Dali	Dali	Dali	
● F017R1LD006	● F017R2LD006	● F017R3LD006	● F017R4LD006	1.225,00 €
● F017R1LD033	● F017R2LD033	● F017R3LD033	● F017R4LD033	1.225,00 €

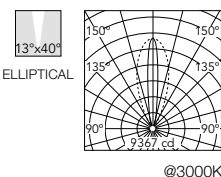

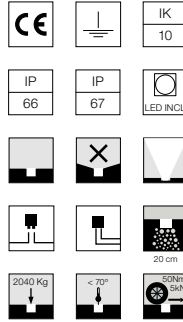
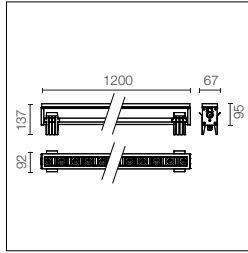

Source LED haute puissance incluse et optique en retrait équipée d'une grille à lamelles asymétrique anti-éblouissement. Alimentation 220-240 V ON-OFF et variable 1-10 V et DALI.
Le coffrage d'installation obligatoire doit être commandé séparément. Précâblé avec les connecteurs rapides H₂O Stop prise/fiche inclus. ACT (Anti Corrosion Treatment) sur demande.

High-power LED source included and rear lenses equipped with anti-glare asymmetrical diffuser grille. 1-10V or DALI on-off and dimmable 220-240V power supply. Compulsory installation box to be ordered separately. Pre-wired with H₂O Stop quick connectors, plug/socket included. ACT (Anti-Corrosion Treatment) upon request.

Optic Spot 15°

Power Led: 33,5W - LED 3726 lm ≠ OUTPUT 954 lm - 2200K/CRI 80 / 33,5W - LED 3864 lm ≠ OUTPUT 989 lm - 2700K/CRI 80 / 33,5W - LED 4140 lm ≠ OUTPUT 1059 lm - 3000K/CRI 80 / 33,5W - LED 4278 lm ≠ OUTPUT 1095 lm - 4000K/CRI 80

2200K	2700K	3000K	4000K	
Non Dimmable	Non Dimmable	Non Dimmable	Non Dimmable	
● F017R1QA006	● F017R2QA006	● F017R3QA006	● F017R4QA006	1.149,00 €
● F017R1QA033	● F017R2QA033	● F017R3QA033	● F017R4QA033	1.149,00 €
1-10V	1-10V	1-10V	1-10V	
● F017R1QB006	● F017R2QB006	● F017R3QB006	● F017R4QB006	1.192,00 €
● F017R1QB033	● F017R2QB033	● F017R3QB033	● F017R4QB033	1.192,00 €
Dali	Dali	Dali	Dali	
● F017R1QD006	● F017R2QD006	● F017R3QD006	● F017R4QD006	1.225,00 €
● F017R1QD033	● F017R2QD033	● F017R3QD033	● F017R4QD033	1.225,00 €

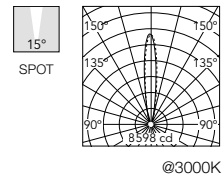

Beam Angle: 15°

h(m)	E(ft)	D(m)
1	8593	0.25
2	2148	0.51
3	955	0.76
4	537	1.02
5	344	1.27

Optic Medium 25°

Power Led: 33,5W - LED 3726 lm ≠ OUTPUT 1009 lm - 2200K/CRI 80 / 33,5W - LED 3864 lm ≠ OUTPUT 1046 lm - 2700K/CRI 80 / 33,5W - LED 4140 lm ≠ OUTPUT 1121 lm - 3000K/CRI 80 / 33,5W - LED 4278 lm ≠ OUTPUT 1158 lm - 4000K/CRI 80

2200K	2700K	3000K	4000K	
Non Dimmable	Non Dimmable	Non Dimmable	Non Dimmable	
● F017R1RA006	● F017R2RA006	● F017R3RA006	● F017R4RA006	1.149,00 €
● F017R1RA033	● F017R2RA033	● F017R3RA033	● F017R4RA033	1.149,00 €
1-10V	1-10V	1-10V	1-10V	
● F017R1RB006	● F017R2RB006	● F017R3RB006	● F017R4RB006	1.192,00 €
● F017R1RB033	● F017R2RB033	● F017R3RB033	● F017R4RB033	1.192,00 €
Dali	Dali	Dali	Dali	
● F017R1RD006	● F017R2RD006	● F017R3RD006	● F017R4RD006	1.225,00 €
● F017R1RD033	● F017R2RD033	● F017R3RD033	● F017R4RD033	1.225,00 €

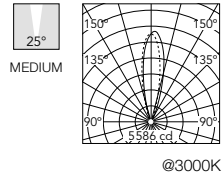

Beam Angle: 25°

h(m)	E(ft)	D(m)
1	5576	0.45
2	1394	0.89
3	620	1.34
4	349	1.78
5	223	2.23

Optic Flood 42°

Power Led: 33,5W - LED 3726 lm ≠ OUTPUT 808 lm - 2200K/CRI 80 / 33,5W - LED 3864 lm ≠ OUTPUT 838 lm - 2700K/CRI 80 / 33,5W - LED 4140 lm ≠ OUTPUT 898 lm - 3000K/CRI 80 / 33,5W - LED 4278 lm ≠ OUTPUT 928 lm - 4000K/CRI 80

2200K	2700K	3000K	4000K	
Non Dimmable	Non Dimmable	Non Dimmable	Non Dimmable	
● F017R1SA006	● F017R2SA006	● F017R3SA006	● F017R4SA006	1.149,00 €
● F017R1SA033	● F017R2SA033	● F017R3SA033	● F017R4SA033	1.149,00 €
1-10V	1-10V	1-10V	1-10V	
● F017R1SB006	● F017R2SB006	● F017R3SB006	● F017R4SB006	1.192,00 €
● F017R1SB033	● F017R2SB033	● F017R3SB033	● F017R4SB033	1.192,00 €
Dali	Dali	Dali	Dali	
● F017R1SD006	● F017R2SD006	● F017R3SD006	● F017R4SD006	1.225,00 €
● F017R1SD033	● F017R2SD033	● F017R3SD033	● F017R4SD033	1.225,00 €

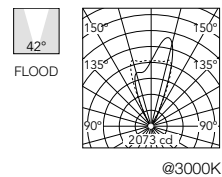

Beam Angle: 42°

h(m)	E(ft)	D(m)
1	1967	0.76
2	492	1.51
3	219	2.27
4	123	3.03
5	79	3.78

Optic Elliptical 12° x 40°

Power Led: 33,5W - LED 3726 lm ≠ OUTPUT 773 lm - 2200K/CRI 80 / 33,5W - LED 3864 lm ≠ OUTPUT 802 lm - 2700K/CRI 80 / 33,5W - LED 4140 lm ≠ OUTPUT 859 lm - 3000K/CRI 80 / 33,5W - LED 4278 lm ≠ OUTPUT 888 lm - 4000K/CRI 80



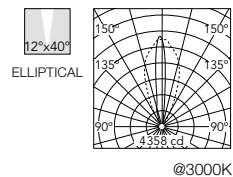









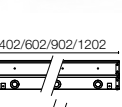
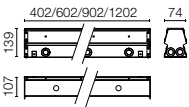

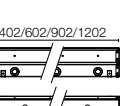
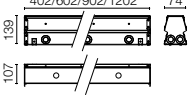

2200K	2700K	3000K	4000K	
Non Dimmable	Non Dimmable	Non Dimmable	Non Dimmable	
● F017R1TA006	● F017R2TA006	● F017R3TA006	● F017R4TA006	1.149,00 €
● F017R1TA033	● F017R2TA033	● F017R3TA033	● F017R4TA033	1.149,00 €
1-10V	1-10V	1-10V	1-10V	
● F017R1TB006	● F017R2TB006	● F017R3TB006	● F017R4TB006	1.192,00 €
● F017R1TB033	● F017R2TB033	● F017R3TB033	● F017R4TB033	1.192,00 €
Dali	Dali	Dali	Dali	
● F017R1TD006	● F017R2TD006	● F017R3TD006	● F017R4TD006	1.225,00 €
● F017R1TD033	● F017R2TD033	● F017R3TD033	● F017R4TD033	1.225,00 €

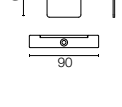

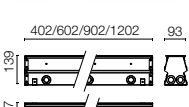
Beam Angle: 12°

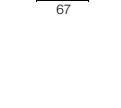
h(m)	E(ft)	D(m)
1	4356	0.21
2	1089	0.42
3	484	0.62
4	272	0.83
5	174	1.04

Ingraze: Accessori / Accessories

Coffrage avec ou sans cadre pour installation simple.	Framed/frameless installation box for single installations.	L 400	149,00 €			
		F017Z110000				
		L 600				
		F017Z120000				
		L 900				
F017Z130000	218,00 €					
L 1200						
F017Z140000	253,00 €					
Coffrage avec cadre pour l'installation simple à fleur.	Framed installation box for single flush installations.	L 400	149,00 €			
		F017Z010000				
		L 600				
		F017Z020000				175,00 €
		L 900				
F017Z030000	218,00 €					
L 1200						
F017Z040000	253,00 €					
Coffrage antivol avec ou sans cadre pour installation simple.	Framed/frameless anti-theft installation box for single installations.	L 400	155,00 €			
		F017Z710000				
		L 600				
		F017Z720000				200,00 €
		L 900				
F017Z730000	244,00 €					
L 1200						
F017Z740000	268,00 €					
Kit fixations antivol avec cadre.	Framed anti-theft bracket kit.	● F017Z550006	55,00 €			
		● F017Z550033	55,00 €			
Coffrage antivol avec cadre complet pour installation simple à fleur.	Complete framed anti-theft installation box for single flush installations.	L 400	155,00 €			
		F017Z610000				
		L 600				
		F017Z620000				200,00 €
		L 900				
F017Z630000	244,00 €					
L 1200						
F017Z640000	268,00 €					
Kit fixations antivol sans cadre.	Frameless anti-theft bracket kit.	● F017Z560006	54,00 €			
		● F017Z560033	54,00 €			



Ingraze: Accessoires / Accessories

Module en rangée continue avec ou sans cadre.	Framed/frameless continuous line module.	L 400			 	
		F017Z211000	111,00 €			
		L 600				
		F017Z221000	158,00 €			
		L 900				
Module en rangée continue avec cadre à fleur.	Framed flush continuous line module.	L 400			 	
		F017Z210000	111,00 €			
		L 600				
		F017Z220000	158,00 €			
		L 900				
Kit embouts standard.	Standard end-plate cover kit.	F017Z490000	48,00 €		 	
Kit plaques de raccordement standard.	Standard connecting plate kit.	F017Z530000	28,00 €		 	
Kit plaques de raccordement antivol.	Anti-theft connecting plate kit.	F017Z531000	30,00 €		 	

Ingraze: Accessoires / Accessories

Système de jonction IP68 H ₂ O Stop anti-condensation à 2 voies 4 pôles.	2 way terminal block 4 poles IP68 H ₂ O Stop.	F990C00A000	33,00 €	 
Système de jonction IP68 H ₂ O Stop anti-condensation à 3/4 voies 4 pôles. (Ø5,5÷12mm câble).	3/4 way terminal block 4 poles IP68 H ₂ O Stop. (Ø5,5÷12mm câble).	F990C010000	60,00 €	 
Boitier de dérivation 5 pôles 4 voies (câbles 6-14 mm).	4 way junction box 5 poles IP68 (6-14 mm cables).	F990C030000	62,00 €	 
Kit de connecteurs à 5 pôles: fiche volante + fiche EU IP68.	Connector kit 5-pole flying socket + EU plug IP68.	F990C080000	48,00 €	 
Kit connecteur 4 pôles prise volante + fiche EU IP68.	4-pin connector kit with detachable socket + IP68 EU plug.	F990C081000	48,00 €	 
Kit connecteur 5 pôles prise volante avec réducteur et capuchon EU.	5-pin connector kit with detachable socket and reducer + EU cap	F990C082000	35,00 €	
Kit connecteur 4 pôles prise volante avec réducteur et capuchon EU.	4-pin connector kit with detachable socket and reducer + EU cap	F990C083000	35,00 €	

Outgraze

Designed by Flos Outdoor



Outgraze





Famille / Family

Outgraze 35 L 300



Power Led

7W
517 lm - 2700K/CRI 80
536 lm - 3000K/CRI 80
554 lm - 4000K/CRI 80

Easy Mid - Power Led

4,5W
190 lm - 2700K/CRI 80
207 lm - 3000K/CRI 80
223 lm - 4000K/CRI 80

Easy Tunable White Mid - Power Led

4,5W
95÷120 lm - 2700K÷5700K/CRI 80

Outgraze 35 L 600



Power Led

12W
1034 lm - 2700K/CRI 80
1071 lm - 3000K/CRI 80
1108 lm - 4000K/CRI 80

Easy Mid - Power Led

9W
381 lm - 2700K/CRI 80
414 lm - 3000K/CRI 80
447 lm - 4000K/CRI 80

Easy Tunable White Mid - Power Led

9W
190÷240 lm - 2700K÷5700K/CRI 80

Outgraze 35 L 900



Power Led

18W
1551 lm - 2700K/CRI 80
1807 lm - 3000K/CRI 80
1662 lm - 4000K/CRI 80

Easy Mid - Power Led

13W
571 lm - 2700K/CRI 80
621 lm - 3000K/CRI 80
670 lm - 4000K/CRI 80

Easy Tunable White Mid - Power Led

13W
285÷360 lm - 2700K÷5700K/CRI 80

Outgraze 35 L 1200



Power Led

23W
2089 lm - 2700K/CRI 80
2142 lm - 3000K/CRI 80
2216 lm - 4000K/CRI 80

Easy Mid - Power Led

17,5W
761 lm - 2700K/CRI 80
827 lm - 3000K/CRI 80
894 lm - 4000K/CRI 80

Easy Tunable White Mid - Power Led

17,5W
381÷480 lm - 2700K÷5700K/CRI 80

Outgraze 50 L 300



Power Led

8W
685 lm - 2700K/CRI 80
709 lm - 3000K/CRI 80
734 lm - 4000K/CRI 80

Easy Mid - Power Led

8W
310 lm - 2700K/CRI 80
337 lm - 3000K/CRI 80
364 lm - 4000K/CRI 80

Easy Tunable White Dali

Mid - Power Led
6,5W
220 lm - 2700K/CRI 80

Outgraze 50 L 600



Power Led

14,5W
1369 lm - 2700K/CRI 80
1418 lm - 3000K/CRI 80
1467 lm - 4000K/CRI 80

Easy Mid - Power Led

14,5W
620 lm - 2700K/CRI 80
674 lm - 3000K/CRI 80
728 lm - 4000K/CRI 80

Easy Tunable White Dali

Mid - Power Led
11W
440 lm - 2700K/CRI 80

RGB - Power Led

26W

RGBW - Power Led

24W

Tunable White - Dali

Mid - Power Led
13W
722 lm - 2700÷5700K/CRI 80

Easy - Dali

Mid - Power Led
14,5W
1106 lm - 2700K/CRI 80
1198 lm - 3000K/CRI 80
1290 lm - 4000K/CRI 80

Outgraze 50 L 900



Power Led

20W
2054 lm - 2700K/CRI 80
2127 lm - 3000K/CRI 80
2201 lm - 4000K/CRI 80

Easy / Easy Dali

Mid - Power Led
20W
930 lm - 2700K/CRI 80
1011 lm - 3000K/CRI 80
1092 lm - 4000K/CRI 80

Easy Tunable White Dali

Mid - Power Led
16W
660 lm - 2700K/CRI 80

RGB - Power Led

37W

RGBW - Power Led

33W

Tunable White - Dali

Mid - Power Led
18,5W
1082 lm - 2700K/CRI 80

Outgraze 50 L 1200



Power Led

27W
2739 lm - 2700K/CRI 80
2836 lm - 3000K/CRI 80
2934 lm - 4000K/CRI 80

Easy / Easy Dali

Mid - Power Led
27W
1240 lm - 2700K/CRI 80
1348 lm - 3000K/CRI 80
1456 lm - 4000K/CRI 80

Easy Tunable White Dali

Mid - Power Led
21W
879 lm - 2700K/CRI 80

RGB - Power Led

48W

RGBW - Power Led

43W

Tunable White - Dali

Mid - Power Led
23W
1443 lm - 2700K/CRI 80

Description / Description

Appareil d'extérieur à LED pour installation au mur ou au plafond.

Corps central en aluminium extrudé, pièces de fermeture en aluminium moulé sous pression.

Optiques réalisées à pas constant entre les lentilles pour offrir un flux lumineux homogène même en cas d'installation de plusieurs lampes en ligne continue.

Revêtement externe à haute résistance appliqué en double couche avec poudres epoxy selon le label QUALICOAT. La première couche de poudres epoxydiques assure la résistance chimique et mécanique. La seconde couche de finition de poudres polyester garantit la résistance aux rayons UV et aux agents atmosphériques.

Les surfaces peintes sont traitées par lavages alcalins et acides, rincées à l'eau déminéralisée puis soumises à un traitement de conversion chimique pour les protéger de l'oxydation.

Diffuseur en verre transparent extra clair ou verre sablé sérigraphié et collé pour garantir l'étanchéité

L'installation du produit nécessite l'utilisation obligatoire de supports en acier, à commander séparément.

Appareils fournis avec un câble en néoprène d'environ 1000 mm sortant sur un côté.

Sur demande, il est possible de fournir les appareils avec raccordement pour installation multiple en ligne continue.

Luminaire for outdoor use for installation on the wall or ceiling with LED light source.

Central body in extruded aluminum, end cap in die-cast aluminum.

Optics made with constant pitch between the lenses to offer a homogeneous luminous flux even in case of multiple lamps installed in a continuous line.

High resistance external coating applied with a double layer of epoxy powders in accordance with the QUALICOAT standard. The first layer of epoxy powder gives chemical and mechanical resistance, the second finishing layer of polyester powder ensures resistance to UV rays and atmospheric agents.

The painted surfaces are treated with alkaline and acidic washes, then rinsed with demineralized water, subjected to a chemical conversion treatment to protect against oxidation. Diffuser in extra clear transparent glass or sandblasted glass, screen-printed and glued to ensure a watertight seal.

The installation of the product requires use of steel brackets, to be ordered separately.

Luminaire provided with a length of approximately 1000 mm of outgoing neoprene cable on one side.

Available versions of luminaires with loop-through connection for multiple installation with continuity of line.

Finitions / Colours

Outgraze



01 White

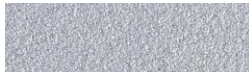

06 Grey

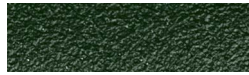

12 Forest Green



18 Deep Brown



30 Black



33 Anthracite

Outgraze



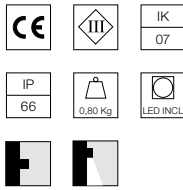
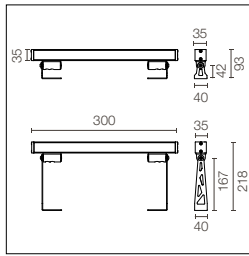

Alimentation électrique à distance 48V et supports d'installation à commander séparément. Verre transparent extra clair, sauf en version DIFFUSE avec verre sablé. Appareils dimmables PWM. Version SMART sur demande (puissance 4W - flux - 50% lm).

48V remote power supply and installation brackets to be ordered separately. Extra clear transparent glass, excluding the DIFFUSE version with sandblasted glass. Dimmable PWM luminaires. SMART version available upon request (power 4W - flux - 50% lm).

Power Led: 7W - 696 lm ≠ *FIXT 517 lm - 2700K/CRI 80 - 48V / 7W - 720 lm ≠ *FIXT 536 lm - 3000K/CRI 80 - 48V / 7W - 745 lm ≠ *FIXT 554 lm - 4000K/CRI 80 - 48V
 *FIXT lm = Medium Optic

1Standard - Schéma électrique n.1 page 644 / Wiring diagram n.1 page 644

2200K	2700K	3000K	4000K	
○ F020A11H001	○ F020A21H001	○ F020A31H001	○ F020A41H001	416,00 €
● F020A11H006	● F020A21H006	● F020A31H006	● F020A41H006	416,00 €
● F020A11H012	● F020A21H012	● F020A31H012	● F020A41H012	416,00 €
● F020A11H018	● F020A21H018	● F020A31H018	● F020A41H018	416,00 €
● F020A11H030	● F020A21H030	● F020A31H030	● F020A41H030	416,00 €
● F020A11H033	● F020A21H033	● F020A31H033	● F020A41H033	416,00 €

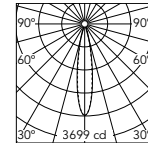

Beam Angle: 18°

h(m)	E(lx)	D(m)
1	3699	0.34
2	925	0.68
3	411	1.02
4	231	1.36
5	148	1.70

@4000K

2Quick Install I H₂O Stop Fast Connect - Schéma électrique n.2 page 644 / Wiring diagram n.2 page 644

2200K	2700K	3000K	4000K	
○ F020B11H001	○ F020B21H001	○ F020B31H001	○ F020B41H001	458,00 €
● F020B11H006	● F020B21H006	● F020B31H006	● F020B41H006	458,00 €
● F020B11H012	● F020B21H012	● F020B31H012	● F020B41H012	458,00 €
● F020B11H018	● F020B21H018	● F020B31H018	● F020B41H018	458,00 €
● F020B11H030	● F020B21H030	● F020B31H030	● F020B41H030	458,00 €
● F020B11H033	● F020B21H033	● F020B31H033	● F020B41H033	458,00 €

1Standard - Schéma électrique n.1 page 644 / Wiring diagram n.1 page 644

2200K	2700K	3000K	4000K	
○ F020A15H001	○ F020A25H001	○ F020A35H001	○ F020A45H001	416,00 €
● F020A15H006	● F020A25H006	● F020A35H006	● F020A45H006	416,00 €
● F020A15H012	● F020A25H012	● F020A35H012	● F020A45H012	416,00 €
● F020A15H018	● F020A25H018	● F020A35H018	● F020A45H018	416,00 €
● F020A15H030	● F020A25H030	● F020A35H030	● F020A45H030	416,00 €
● F020A15H033	● F020A25H033	● F020A35H033	● F020A45H033	416,00 €

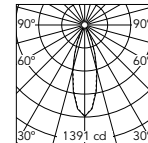

Beam Angle: 30°

h(m)	E(lx)	D(m)
1	1391	0.55
2	348	1.11
3	155	1.66
4	87	2.22
5	56	2.77

@4000K

2Quick Install I H₂O Stop Fast Connect - Schéma électrique n.2 page 644 / Wiring diagram n.2 page 644

2200K	2700K	3000K	4000K	
○ F020B15H001	○ F020B25H001	○ F020B35H001	○ F020B45H001	458,00 €
● F020B15H006	● F020B25H006	● F020B35H006	● F020B45H006	458,00 €
● F020B15H012	● F020B25H012	● F020B35H012	● F020B45H012	458,00 €
● F020B15H018	● F020B25H018	● F020B35H018	● F020B45H018	458,00 €
● F020B15H030	● F020B25H030	● F020B35H030	● F020B45H030	458,00 €
● F020B15H033	● F020B25H033	● F020B35H033	● F020B45H033	458,00 €

1Standard - Schéma électrique n.1 page 644 / Wiring diagram n.1 page 644

2200K	2700K	3000K	4000K	
○ F020A1AH001	○ F020A2AH001	○ F020A3AH001	○ F020A4AH001	416,00 €
● F020A1AH006	● F020A2AH006	● F020A3AH006	● F020A4AH006	416,00 €
● F020A1AH012	● F020A2AH012	● F020A3AH012	● F020A4AH012	416,00 €
● F020A1AH018	● F020A2AH018	● F020A3AH018	● F020A4AH018	416,00 €
● F020A1AH030	● F020A2AH030	● F020A3AH030	● F020A4AH030	416,00 €
● F020A1AH033	● F020A2AH033	● F020A3AH033	● F020A4AH033	416,00 €

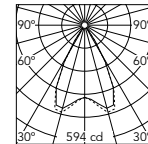

Beam Angle: 59°

h(m)	E(lx)	D(m)
1	594	1.14
2	148	2.28
3	66	3.41
4	37	4.55
5	24	5.69

@4000K

2Quick Install I H₂O Stop Fast Connect - Schéma électrique n.2 page 644 / Wiring diagram n.2 page 644

2200K	2700K	3000K	4000K	
○ F020B1AH001	○ F020B2AH001	○ F020B3AH001	○ F020B4AH001	458,00 €
● F020B1AH006	● F020B2AH006	● F020B3AH006	● F020B4AH006	458,00 €
● F020B1AH012	● F020B2AH012	● F020B3AH012	● F020B4AH012	458,00 €
● F020B1AH018	● F020B2AH018	● F020B3AH018	● F020B4AH018	458,00 €
● F020B1AH030	● F020B2AH030	● F020B3AH030	● F020B4AH030	458,00 €
● F020B1AH033	● F020B2AH033	● F020B3AH033	● F020B4AH033	458,00 €

*Standard Version: câble en sortie long. 1000 mm (accessoires de connexion à commander séparément) / 1000 mm length prewired cable (connecting accessory to be separately ordered).

*Quick Install In H₂O Stop Version: Connecteur H₂O Stop Plug&Play préinstallé pour connexion rapide (accessoires de connexion à commander séparément) / Prewired H₂O Stop Plug&Play connector for an easy/rapid connection (connecting accessory to be ordered separately).

1Standard - Schéma électrique n.1 page 644 / Wiring diagram n.1 page 644

2200K		2700K		3000K		4000K	
○ F020A1EH001	○ F020A2EH001	○ F020A3EH001	○ F020A4EH001	○ F020A1EH006	○ F020A2EH006	○ F020A3EH006	○ F020A4EH006
● F020A1EH012	● F020A2EH012	● F020A3EH012	● F020A4EH012	● F020A1EH018	● F020A2EH018	● F020A3EH018	● F020A4EH018
● F020A1EH030	● F020A2EH030	● F020A3EH030	● F020A4EH030	● F020A1EH033	● F020A2EH033	● F020A3EH033	● F020A4EH033
							416,00 €
							416,00 €
							416,00 €
							416,00 €
							416,00 €

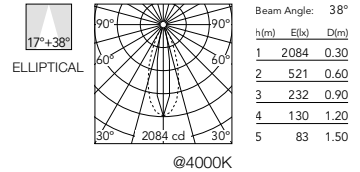

2Quick Install I H₂O Stop Fast Connect - Schéma électrique n.2 page 644 / Wiring diagram n.2 page 644

2200K		2700K		3000K		4000K	
○ F020B1EH001	○ F020B2EH001	○ F020B3EH001	○ F020B4EH001	○ F020B1EH006	○ F020B2EH006	○ F020B3EH006	○ F020B4EH006
● F020B1EH012	● F020B2EH012	● F020B3EH012	● F020B4EH012	● F020B1EH018	● F020B2EH018	● F020B3EH018	● F020B4EH018
● F020B1EH030	● F020B2EH030	● F020B3EH030	● F020B4EH030	● F020B1EH033	● F020B2EH033	● F020B3EH033	● F020B4EH033
							458,00 €
							458,00 €
							458,00 €
							458,00 €
							458,00 €

1Standard - Schéma électrique n.1 page 644 / Wiring diagram n.1 page 644

2200K		2700K		3000K		4000K	
○ F020A1JH001	○ F020A2JH001	○ F020A3JH001	○ F020A4JH001	○ F020A1JH006	○ F020A2JH006	○ F020A3JH006	○ F020A4JH006
● F020A1JH012	● F020A2JH012	● F020A3JH012	● F020A4JH012	● F020A1JH018	● F020A2JH018	● F020A3JH018	● F020A4JH018
● F020A1JH030	● F020A2JH030	● F020A3JH030	● F020A4JH030	● F020A1JH033	● F020A2JH033	● F020A3JH033	● F020A4JH033
							416,00 €
							416,00 €
							416,00 €
							416,00 €
							416,00 €

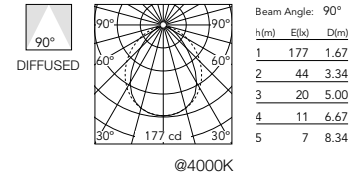

2Quick Install I H₂O Stop Fast Connect - Schéma électrique n.2 page 644 / Wiring diagram n.2 page 644

2200K		2700K		3000K		4000K	
○ F020B1JH001	○ F020B2JH001	○ F020B3JH001	○ F020B4JH001	○ F020B1JH006	○ F020B2JH006	○ F020B3JH006	○ F020B4JH006
● F020B1JH012	● F020B2JH012	● F020B3JH012	● F020B4JH012	● F020B1JH018	● F020B2JH018	● F020B3JH018	● F020B4JH018
● F020B1JH030	● F020B2JH030	● F020B3JH030	● F020B4JH030	● F020B1JH033	● F020B2JH033	● F020B3JH033	● F020B4JH033
							458,00 €
							458,00 €
							458,00 €
							458,00 €
							458,00 €

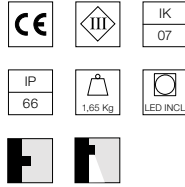
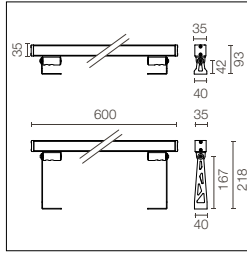

Alimentation électrique à distance 48V et supports d'installation à commander séparément. Verre transparent extra clair, sauf en version DIFFUSE avec verre sablé. Appareils dimmables PWM.
Version SMART sur demande (puissance 7W - flux - 50% lm).

48V remote power supply and installation brackets to be ordered separately. Extra clear transparent glass, excluding the DIFFUSE version with sandblasted glass. Dimmable PWM luminaires. SMART version available upon request (power 7W - flux - 50% lm).

Power Led: 12W - 1391 lm ≠ *FIXT 1034 lm - 2700K/CRI 80 - 48V / 12W - 1441 lm ≠ *FIXT 1071 lm - 3000K/CRI 80 - 48V / 12W - 1490 lm ≠ *FIXT 1108 lm - 4000K/CRI 80 - 48V
*FIXT lm = Medium Optic

1Standard - Schéma électrique n.1 page 644 / Wiring diagram n.1 page 644

2200K	2700K	3000K	4000K	
○ F020A12H001	○ F020A22H001	○ F020A32H001	○ F020A42H001	519,00 €
● F020A12H006	● F020A22H006	● F020A32H006	● F020A42H006	519,00 €
● F020A12H012	● F020A22H012	● F020A32H012	● F020A42H012	519,00 €
● F020A12H018	● F020A22H018	● F020A32H018	● F020A42H018	519,00 €
● F020A12H030	● F020A22H030	● F020A32H030	● F020A42H030	519,00 €
● F020A12H033	● F020A22H033	● F020A32H033	● F020A42H033	519,00 €

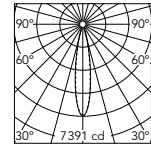

Beam Angle: 18°

H(m)	E(lx)	D(m)
1	7391	0.34
2	1848	0.68
3	821	1.02
4	462	1.36
5	296	1.70

@4000K

2Quick Install I H₂O Stop Fast Connect - Schéma électrique n.2 page 644 / Wiring diagram n.2 page 644

2200K	2700K	3000K	4000K	
○ F020B12H001	○ F020B22H001	○ F020B32H001	○ F020B42H001	560,00 €
● F020B12H006	● F020B22H006	● F020B32H006	● F020B42H006	560,00 €
● F020B12H012	● F020B22H012	● F020B32H012	● F020B42H012	560,00 €
● F020B12H018	● F020B22H018	● F020B32H018	● F020B42H018	560,00 €
● F020B12H030	● F020B22H030	● F020B32H030	● F020B42H030	560,00 €
● F020B12H033	● F020B22H033	● F020B32H033	● F020B42H033	560,00 €

3Continuous Line I/O H₂O Stop Fast Connect - Schéma électrique n.3 page 644 / Wiring diagram n.3 page 644

2200K	2700K	3000K	4000K	
○ F020C12H001	○ F020C22H001	○ F020C32H001	○ F020C42H001	601,00 €
● F020C12H006	● F020C22H006	● F020C32H006	● F020C42H006	601,00 €
● F020C12H012	● F020C22H012	● F020C32H012	● F020C42H012	601,00 €
● F020C12H018	● F020C22H018	● F020C32H018	● F020C42H018	601,00 €
● F020C12H030	● F020C22H030	● F020C32H030	● F020C42H030	601,00 €
● F020C12H033	● F020C22H033	● F020C32H033	● F020C42H033	601,00 €

1Standard - Schéma électrique n.1 page 644 / Wiring diagram n.1 page 644

2200K	2700K	3000K	4000K	
○ F020A16H001	○ F020A26H001	○ F020A36H001	○ F020A46H001	519,00 €
● F020A16H006	● F020A26H006	● F020A36H006	● F020A46H006	519,00 €
● F020A16H012	● F020A26H012	● F020A36H012	● F020A46H012	519,00 €
● F020A16H018	● F020A26H018	● F020A36H018	● F020A46H018	519,00 €
● F020A16H030	● F020A26H030	● F020A36H030	● F020A46H030	519,00 €
● F020A16H033	● F020A26H033	● F020A36H033	● F020A46H033	519,00 €

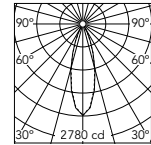

Beam Angle: 30°

H(m)	E(lx)	D(m)
1	2780	0.55
2	695	1.11
3	309	1.66
4	174	2.22
5	111	2.77

@4000K

2Quick Install I H₂O Stop Fast Connect - Schéma électrique n.2 page 644 / Wiring diagram n.2 page 644

2200K	2700K	3000K	4000K	
○ F020B16H001	○ F020B26H001	○ F020B36H001	○ F020B46H001	560,00 €
● F020B16H006	● F020B26H006	● F020B36H006	● F020B46H006	560,00 €
● F020B16H012	● F020B26H012	● F020B36H012	● F020B46H012	560,00 €
● F020B16H018	● F020B26H018	● F020B36H018	● F020B46H018	560,00 €
● F020B16H030	● F020B26H030	● F020B36H030	● F020B46H030	560,00 €
● F020B16H033	● F020B26H033	● F020B36H033	● F020B46H033	560,00 €

3Continuous Line I/O H₂O Stop Fast Connect - Schéma électrique n.3 page 644 / Wiring diagram n.3 page 644

2200K	2700K	3000K	4000K	
○ F020C16H001	○ F020C26H001	○ F020C36H001	○ F020C46H001	601,00 €
● F020C16H006	● F020C26H006	● F020C36H006	● F020C46H006	601,00 €
● F020C16H012	● F020C26H012	● F020C36H012	● F020C46H012	601,00 €
● F020C16H018	● F020C26H018	● F020C36H018	● F020C46H018	601,00 €
● F020C16H030	● F020C26H030	● F020C36H030	● F020C46H030	601,00 €
● F020C16H033	● F020C26H033	● F020C36H033	● F020C46H033	601,00 €

*Standard Version: câble en sortie long. 1000 mm (accessoires de connexion à commander séparément) / 1000 mm length prewired cable (connecting accessory to be separately ordered).

2Quick Install In H₂O Stop Version: Connecteur H₂O Stop Plug&Play préinstallé pour connexion rapide (accessoires de connexion à commander séparément) / Prewired H₂O Stop Plug&Play connector for an easy/rapid connection (connecting accessory to be ordered separately).

3Continuous Line In/Out H₂O Stop Version: Connecteurs H₂O Stop Plug&Play préinstallés pour connexion en ligne (accessoires de connexion à commander séparément) / Prewired H₂O Stop Plug&Play connectors for an easy in line connection (connecting accessory to be ordered separately).

1Standard - Schéma électrique n.1 page 644 / Wiring diagram n.1 page 644

2200K		2700K		3000K		4000K		
○ F020A1BH001	○ F020A2BH001	○ F020A3BH001	○ F020A4BH001					519,00 €
● F020A1BH006	● F020A2BH006	● F020A3BH006	● F020A4BH006					519,00 €
● F020A1BH012	● F020A2BH012	● F020A3BH012	● F020A4BH012					519,00 €
● F020A1BH018	● F020A2BH018	● F020A3BH018	● F020A4BH018					519,00 €
● F020A1BH030	● F020A2BH030	● F020A3BH030	● F020A4BH030					519,00 €
● F020A1BH033	● F020A2BH033	● F020A3BH033	● F020A4BH033					519,00 €

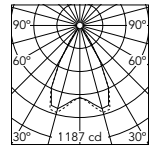

Beam Angle: 59°

h(m)	E(lx)	D(m)
1	1187	1.14
2	297	2.28
3	132	3.41
4	74	4.55
5	47	5.69

@4000K

2Quick Install I H₂O Stop Fast Connect - Schéma électrique n.2 page 644 / Wiring diagram n.2 page 644

2200K		2700K		3000K		4000K		
○ F020B1BH001	○ F020B2BH001	○ F020B3BH001	○ F020B4BH001					560,00 €
● F020B1BH006	● F020B2BH006	● F020B3BH006	● F020B4BH006					560,00 €
● F020B1BH012	● F020B2BH012	● F020B3BH012	● F020B4BH012					560,00 €
● F020B1BH018	● F020B2BH018	● F020B3BH018	● F020B4BH018					560,00 €
● F020B1BH030	● F020B2BH030	● F020B3BH030	● F020B4BH030					560,00 €
● F020B1BH033	● F020B2BH033	● F020B3BH033	● F020B4BH033					560,00 €

3Continuous Line I/O H₂O Stop Fast Connect - Schéma électrique n.3 page 644 / Wiring diagram n.3 page 644

2200K		2700K		3000K		4000K		
○ F020C1BH001	○ F020C2BH001	○ F020C3BH001	○ F020C4BH001					601,00 €
● F020C1BH006	● F020C2BH006	● F020C3BH006	● F020C4BH006					601,00 €
● F020C1BH012	● F020C2BH012	● F020C3BH012	● F020C4BH012					601,00 €
● F020C1BH018	● F020C2BH018	● F020C3BH018	● F020C4BH018					601,00 €
● F020C1BH030	● F020C2BH030	● F020C3BH030	● F020C4BH030					601,00 €
● F020C1BH033	● F020C2BH033	● F020C3BH033	● F020C4BH033					601,00 €

1Standard - Schéma électrique n.1 page 644 / Wiring diagram n.1 page 644

2200K		2700K		3000K		4000K		
○ F020A1FH001	○ F020A2FH001	○ F020A3FH001	○ F020A4FH001					519,00 €
● F020A1FH006	● F020A2FH006	● F020A3FH006	● F020A4FH006					519,00 €
● F020A1FH012	● F020A2FH012	● F020A3FH012	● F020A4FH012					519,00 €
● F020A1FH018	● F020A2FH018	● F020A3FH018	● F020A4FH018					519,00 €
● F020A1FH030	● F020A2FH030	● F020A3FH030	● F020A4FH030					519,00 €
● F020A1FH033	● F020A2FH033	● F020A3FH033	● F020A4FH033					519,00 €

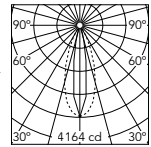

Beam Angle: 38°

h(m)	E(lx)	D(m)
1	4164	0.30
2	1041	0.60
3	463	0.90
4	260	1.20
5	167	1.50

@4000K

2Quick Install I H₂O Stop Fast Connect - Schéma électrique n.2 page 644 / Wiring diagram n.2 page 644

2200K		2700K		3000K		4000K		
○ F020B1FH001	○ F020B2FH001	○ F020B3FH001	○ F020B4FH001					560,00 €
● F020B1FH006	● F020B2FH006	● F020B3FH006	● F020B4FH006					560,00 €
● F020B1FH012	● F020B2FH012	● F020B3FH012	● F020B4FH012					560,00 €
● F020B1FH018	● F020B2FH018	● F020B3FH018	● F020B4FH018					560,00 €
● F020B1FH030	● F020B2FH030	● F020B3FH030	● F020B4FH030					560,00 €
● F020B1FH033	● F020B2FH033	● F020B3FH033	● F020B4FH033					560,00 €

3Continuous Line I/O H₂O Stop Fast Connect - Schéma électrique n.3 page 644 / Wiring diagram n.3 page 644

2200K		2700K		3000K		4000K		
○ F020C1FH001	○ F020C2FH001	○ F020C3FH001	○ F020C4FH001					601,00 €
● F020C1FH006	● F020C2FH006	● F020C3FH006	● F020C4FH006					601,00 €
● F020C1FH012	● F020C2FH012	● F020C3FH012	● F020C4FH012					601,00 €
● F020C1FH018	● F020C2FH018	● F020C3FH018	● F020C4FH018					601,00 €
● F020C1FH030	● F020C2FH030	● F020C3FH030	● F020C4FH030					601,00 €
● F020C1FH033	● F020C2FH033	● F020C3FH033	● F020C4FH033					601,00 €

1Standard - Schéma électrique n.1 page 644 / Wiring diagram n.1 page 644

2200K		2700K		3000K		4000K		
○ F020A1KH001	○ F020A2KH001	○ F020A3KH001	○ F020A4KH001					519,00 €
● F020A1KH006	● F020A2KH006	● F020A3KH006	● F020A4KH006					519,00 €
● F020A1KH012	● F020A2KH012	● F020A3KH012	● F020A4KH012					519,00 €
● F020A1KH018	● F020A2KH018	● F020A3KH018	● F020A4KH018					519,00 €
● F020A1KH030	● F020A2KH030	● F020A3KH030	● F020A4KH030					519,00 €
● F020A1KH033	● F020A2KH033	● F020A3KH033	● F020A4KH033					519,00 €

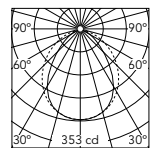

Beam Angle: 90°

h(m)	E(lx)	D(m)
1	353	1.67
2	88	3.34
3	39	5.00
4	22	6.67
5	14	8.34

@4000K

2Quick Install I H₂O Stop Fast Connect - Schéma électrique n.2 page 644 / Wiring diagram n.2 page 644

2200K		2700K		3000K		4000K		
○ F020B1KH001	○ F020B2KH001	○ F020B3KH001	○ F020B4KH001					560,00 €
● F020B1KH006	● F020B2KH006	● F020B3KH006	● F020B4KH006					560,00 €
● F020B1KH012	● F020B2KH012	● F020B3KH012	● F020B4KH012					560,00 €
● F020B1KH018	● F020B2KH018	● F020B3KH018	● F020B4KH018					560,00 €
● F020B1KH030	● F020B2KH030	● F020B3KH030	● F020B4KH030					560,00 €
● F020B1KH033	● F020B2KH033	● F020B3KH033	● F020B4KH033					560,00 €

3Continuous Line I/O H₂O Stop Fast Connect - Schéma électrique n.3 page 644 / Wiring diagram n.3 page 644

2200K		2700K		3000K		4000K		
○ F020C1KH001	○ F020C2KH001	○ F020C3KH001	○ F020C4KH001					601,00 €
● F020C1KH006	● F020C2KH006	● F020C3KH006	● F020C4KH006					601,00 €
● F020C1KH012	● F020C2KH012	● F020C3KH012	● F020C4KH012					601,00 €
● F020C1KH018	● F020C2KH018	● F020C3KH018	● F020C4KH018					601,00 €
● F020C1KH030	● F020C2KH030	● F020C3KH030	● F020C4KH030					601,00 €
● F020C1KH033	● F020C2KH033	● F020C3KH033	● F020C4KH033					601,00 €

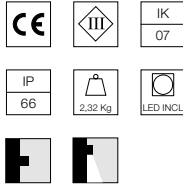
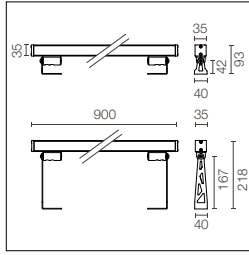

Alimentation électrique à distance 48V et supports d'installation à commander séparément. Verre transparent extra clair, sauf en version DIFFUSE avec verre sablé. Appareils dimmables PWM. Version SMART sur demande (puissance 11W - flux - 50% lm).

48V remote power supply and installation brackets to be ordered separately. Extra clear transparent glass, excluding the DIFFUSE version with sandblasted glass. Dimmable PWM luminaires. SMART version available upon request (power 11W - flux -50% lm).

Power Led: 18W - 2087 lm ≠ *FIXT 1551 lm - 2700K/CRI 80 - 48V / 18W - 2161 lm ≠ *FIXT 1607 lm - 3000K/CRI 80 - 48V / 18W - 2236 lm ≠ *FIXT 1662 lm - 4000K/CRI 80 - 48V
 *FIXT lm = Medium Optic

1Standard - Schéma électrique n.1 page 644 / Wiring diagram n.1 pag. 644

2200K	2700K	3000K	4000K	
○ F020A13H001	○ F020A23H001	○ F020A33H001	○ F020A43H001	674,00 €
● F020A13H006	● F020A23H006	● F020A33H006	● F020A43H006	674,00 €
● F020A13H012	● F020A23H012	● F020A33H012	● F020A43H012	674,00 €
● F020A13H018	● F020A23H018	● F020A33H018	● F020A43H018	674,00 €
● F020A13H030	● F020A23H030	● F020A33H030	● F020A43H030	674,00 €
● F020A13H033	● F020A23H033	● F020A33H033	● F020A43H033	674,00 €

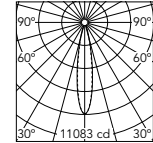

Beam Angle: 18°

h(m)	E(lx)	D(m)
1	11083	0.34
2	2771	0.68
3	1231	1.02
4	693	1.36
5	443	1.70

@4000K

2Quick Install I H₂O Stop Fast Connect - Schéma électrique n.2 page 644 / Wiring diagram n.2 page 644

2200K	2700K	3000K	4000K	
○ F020B13H001	○ F020B23H001	○ F020B33H001	○ F020B43H001	716,00 €
● F020B13H006	● F020B23H006	● F020B33H006	● F020B43H006	716,00 €
● F020B13H012	● F020B23H012	● F020B33H012	● F020B43H012	716,00 €
● F020B13H018	● F020B23H018	● F020B33H018	● F020B43H018	716,00 €
● F020B13H030	● F020B23H030	● F020B33H030	● F020B43H030	716,00 €
● F020B13H033	● F020B23H033	● F020B33H033	● F020B43H033	716,00 €

3Continuous Line I/O H₂O Stop Fast Connect - Schéma électrique n.3 page 644 / Wiring diagram n.3 page 644

2200K	2700K	3000K	4000K	
○ F020C13H001	○ F020C23H001	○ F020C33H001	○ F020C43H001	758,00 €
● F020C13H006	● F020C23H006	● F020C33H006	● F020C43H006	758,00 €
● F020C13H012	● F020C23H012	● F020C33H012	● F020C43H012	758,00 €
● F020C13H018	● F020C23H018	● F020C33H018	● F020C43H018	758,00 €
● F020C13H030	● F020C23H030	● F020C33H030	● F020C43H030	758,00 €
● F020C13H033	● F020C23H033	● F020C33H033	● F020C43H033	758,00 €

1Standard - Schéma électrique n.1 page 644 / Wiring diagram n.1 page 644

2200K	2700K	3000K	4000K	
○ F020A17H001	○ F020A27H001	○ F020A37H001	○ F020A47H001	674,00 €
● F020A17H006	● F020A27H006	● F020A37H006	● F020A47H006	674,00 €
● F020A17H012	● F020A27H012	● F020A37H012	● F020A47H012	674,00 €
● F020A17H018	● F020A27H018	● F020A37H018	● F020A47H018	674,00 €
● F020A17H030	● F020A27H030	● F020A37H030	● F020A47H030	674,00 €
● F020A17H033	● F020A27H033	● F020A37H033	● F020A47H033	674,00 €

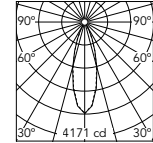

Beam Angle: 30°

h(m)	E(lx)	D(m)
1	4171	0.55
2	1043	1.11
3	463	1.66
4	261	2.22
5	167	2.77

@4000K

2Quick Install I H₂O Stop Fast Connect - Schéma électrique n.2 page 644 / Wiring diagram n.2 page 644

2200K	2700K	3000K	4000K	
○ F020B17H001	○ F020B27H001	○ F020B37H001	○ F020B47H001	716,00 €
● F020B17H006	● F020B27H006	● F020B37H006	● F020B47H006	716,00 €
● F020B17H012	● F020B27H012	● F020B37H012	● F020B47H012	716,00 €
● F020B17H018	● F020B27H018	● F020B37H018	● F020B47H018	716,00 €
● F020B17H030	● F020B27H030	● F020B37H030	● F020B47H030	716,00 €
● F020B17H033	● F020B27H033	● F020B37H033	● F020B47H033	716,00 €

3Continuous Line I/O H₂O Stop Fast Connect - Schéma électrique n.3 page 644 / Wiring diagram n.3 page 644

2200K	2700K	3000K	4000K	
○ F020C17H001	○ F020C27H001	○ F020C37H001	○ F020C47H001	758,00 €
● F020C17H006	● F020C27H006	● F020C37H006	● F020C47H006	758,00 €
● F020C17H012	● F020C27H012	● F020C37H012	● F020C47H012	758,00 €
● F020C17H018	● F020C27H018	● F020C37H018	● F020C47H018	758,00 €
● F020C17H030	● F020C27H030	● F020C37H030	● F020C47H030	758,00 €
● F020C17H033	● F020C27H033	● F020C37H033	● F020C47H033	758,00 €

*Standard Version: câble en sortie long. 1000 mm (accessoires de connexion à commander séparément) / 1000 mm length prewired cable (connecting accessory to be separately ordered).

2Quick Install In H₂O Stop Version: Connecteur H₂O Stop Plug&Play préinstallé pour connexion rapide (accessoires de connexion à commander séparément) / Prewired H₂O Stop Plug&Play connector for an easy/rapid connection (connecting accessory to be ordered separately).

3Continuous Line In/Out H₂O Stop Version: Connecteurs H₂O Stop Plug&Play préinstallés pour connexion en ligne (accessoires de connexion à commander séparément) / Prewired H₂O Stop Plug&Play connectors for an easy in line connection (connecting accessory to be ordered separately).

¹Standard - Schéma électrique n.1 page 644 / Wiring diagram n.1 page 644

2200K		2700K		3000K		4000K	
○ F020A1CH001	○ F020A2CH001	○ F020A3CH001	○ F020A4CH001	○ F020A4CH001	674,00 €		
● F020A1CH006	● F020A2CH006	● F020A3CH006	● F020A4CH006	● F020A4CH006	674,00 €		
● F020A1CH012	● F020A2CH012	● F020A3CH012	● F020A4CH012	● F020A4CH012	674,00 €		
● F020A1CH018	● F020A2CH018	● F020A3CH018	● F020A4CH018	● F020A4CH018	674,00 €		
● F020A1CH030	● F020A2CH030	● F020A3CH030	● F020A4CH030	● F020A4CH030	674,00 €		
● F020A1CH033	● F020A2CH033	● F020A3CH033	● F020A4CH033	● F020A4CH033	674,00 €		



FLOOD

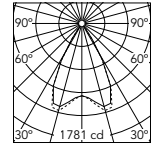

@4000K

Beam Angle: 59°

h(m)	E(lx)	D(m)
1	1781	1.14
2	445	2.28
3	198	3.41
4	111	4.55
5	71	5.69

²Quick Install I H₂O Stop Fast Connect - Schéma électrique n.2 page 644 / Wiring diagram n.2 page 644

2200K		2700K		3000K		4000K	
○ F020B1CH001	○ F020B2CH001	○ F020B3CH001	○ F020B4CH001	○ F020B4CH001	716,00 €		
● F020B1CH006	● F020B2CH006	● F020B3CH006	● F020B4CH006	● F020B4CH006	716,00 €		
● F020B1CH012	● F020B2CH012	● F020B3CH012	● F020B4CH012	● F020B4CH012	716,00 €		
● F020B1CH018	● F020B2CH018	● F020B3CH018	● F020B4CH018	● F020B4CH018	716,00 €		
● F020B1CH030	● F020B2CH030	● F020B3CH030	● F020B4CH030	● F020B4CH030	716,00 €		
● F020B1CH033	● F020B2CH033	● F020B3CH033	● F020B4CH033	● F020B4CH033	716,00 €		

³Continuous Line I/O H₂O Stop Fast Connect - Schéma électrique n.3 page 644 / Wiring diagram n.3 page 644

2200K		2700K		3000K		4000K	
○ F020C1CH001	○ F020C2CH001	○ F020C3CH001	○ F020C4CH001	○ F020C4CH001	758,00 €		
● F020C1CH006	● F020C2CH006	● F020C3CH006	● F020C4CH006	● F020C4CH006	758,00 €		
● F020C1CH012	● F020C2CH012	● F020C3CH012	● F020C4CH012	● F020C4CH012	758,00 €		
● F020C1CH018	● F020C2CH018	● F020C3CH018	● F020C4CH018	● F020C4CH018	758,00 €		
● F020C1CH030	● F020C2CH030	● F020C3CH030	● F020C4CH030	● F020C4CH030	758,00 €		
● F020C1CH033	● F020C2CH033	● F020C3CH033	● F020C4CH033	● F020C4CH033	758,00 €		

¹Standard - Schéma électrique n.1 page 644 / Wiring diagram n.1 page 644

2200K		2700K		3000K		4000K	
○ F020A1GH001	○ F020A2GH001	○ F020A3GH001	○ F020A4GH001	○ F020A4GH001	674,00 €		
● F020A1GH006	● F020A2GH006	● F020A3GH006	● F020A4GH006	● F020A4GH006	674,00 €		
● F020A1GH012	● F020A2GH012	● F020A3GH012	● F020A4GH012	● F020A4GH012	674,00 €		
● F020A1GH018	● F020A2GH018	● F020A3GH018	● F020A4GH018	● F020A4GH018	674,00 €		
● F020A1GH030	● F020A2GH030	● F020A3GH030	● F020A4GH030	● F020A4GH030	674,00 €		
● F020A1GH033	● F020A2GH033	● F020A3GH033	● F020A4GH033	● F020A4GH033	674,00 €		



ELLIPTICAL

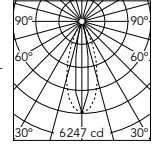

@4000K

Beam Angle: 38°

h(m)	E(lx)	D(m)
1	6247	0.30
2	1562	0.60
3	694	0.90
4	390	1.20
5	250	1.50

²Quick Install I H₂O Stop Fast Connect - Schéma électrique n.2 page 644 / Wiring diagram n.2 page 644

2200K		2700K		3000K		4000K	
○ F020B1GH001	○ F020B2GH001	○ F020B3GH001	○ F020B4GH001	○ F020B4GH001	716,00 €		
● F020B1GH006	● F020B2GH006	● F020B3GH006	● F020B4GH006	● F020B4GH006	716,00 €		
● F020B1GH012	● F020B2GH012	● F020B3GH012	● F020B4GH012	● F020B4GH012	716,00 €		
● F020B1GH018	● F020B2GH018	● F020B3GH018	● F020B4GH018	● F020B4GH018	716,00 €		
● F020B1GH030	● F020B2GH030	● F020B3GH030	● F020B4GH030	● F020B4GH030	716,00 €		
● F020B1GH033	● F020B2GH033	● F020B3GH033	● F020B4GH033	● F020B4GH033	716,00 €		

³Continuous Line I/O H₂O Stop Fast Connect - Schéma électrique n.3 page 644 / Wiring diagram n.3 page 644

2200K		2700K		3000K		4000K	
○ F020C1GH001	○ F020C2GH001	○ F020C3GH001	○ F020C4GH001	○ F020C4GH001	758,00 €		
● F020C1GH006	● F020C2GH006	● F020C3GH006	● F020C4GH006	● F020C4GH006	758,00 €		
● F020C1GH012	● F020C2GH012	● F020C3GH012	● F020C4GH012	● F020C4GH012	758,00 €		
● F020C1GH018	● F020C2GH018	● F020C3GH018	● F020C4GH018	● F020C4GH018	758,00 €		
● F020C1GH030	● F020C2GH030	● F020C3GH030	● F020C4GH030	● F020C4GH030	758,00 €		
● F020C1GH033	● F020C2GH033	● F020C3GH033	● F020C4GH033	● F020C4GH033	758,00 €		

¹Standard - Schéma électrique n.1 page 644 / Wiring diagram n.1 page 644

2200K		2700K		3000K		4000K	
○ F020A1LH001	○ F020A2LH001	○ F020A3LH001	○ F020A4LH001	○ F020A4LH001	674,00 €		
● F020A1LH006	● F020A2LH006	● F020A3LH006	● F020A4LH006	● F020A4LH006	674,00 €		
● F020A1LH012	● F020A2LH012	● F020A3LH012	● F020A4LH012	● F020A4LH012	674,00 €		
● F020A1LH018	● F020A2LH018	● F020A3LH018	● F020A4LH018	● F020A4LH018	674,00 €		
● F020A1LH030	● F020A2LH030	● F020A3LH030	● F020A4LH030	● F020A4LH030	674,00 €		
● F020A1LH033	● F020A2LH033	● F020A3LH033	● F020A4LH033	● F020A4LH033	674,00 €		



DIFFUSED

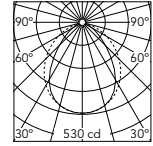

@4000K

Beam Angle: 90°

h(m)	E(lx)	D(m)
1	530	1.67
2	132	3.34
3	59	5.00
4	33	6.67
5	21	8.34

²Quick Install I H₂O Stop Fast Connect - Schéma électrique n.2 page 644 / Wiring diagram n.2 page 626

2200K		2700K		3000K		4000K	
○ F020B1LH001	○ F020B2LH001	○ F020B3LH001	○ F020B4LH001	○ F020B4LH001	716,00 €		
● F020B1LH006	● F020B2LH006	● F020B3LH006	● F020B4LH006	● F020B4LH006	716,00 €		
● F020B1LH012	● F020B2LH012	● F020B3LH012	● F020B4LH012	● F020B4LH012	716,00 €		
● F020B1LH018	● F020B2LH018	● F020B3LH018	● F020B4LH018	● F020B4LH018	716,00 €		
● F020B1LH030	● F020B2LH030	● F020B3LH030	● F020B4LH030	● F020B4LH030	716,00 €		
● F020B1LH033	● F020B2LH033	● F020B3LH033	● F020B4LH033	● F020B4LH033	716,00 €		

³Continuous Line I/O H₂O Stop Fast Connect - Schéma électrique n.3 page 644 / Wiring diagram n.3 page 644

2200K		2700K		3000K		4000K	
○ F020C1LH001	○ F020C2LH001	○ F020C3LH001	○ F020C4LH001	○ F020C4LH001	758,00 €		
● F020C1LH006	● F020C2LH006	● F020C3LH006	● F020C4LH006	● F020C4LH006	758,00 €		
● F020C1LH012	● F020C2LH012	● F020C3LH012	● F020C4LH012	● F020C4LH012	758,00 €		
● F020C1LH018	● F020C2LH018	● F020C3LH018	● F020C4LH018	● F020C4LH018	758,00 €		
● F020C1LH030	● F020C2LH030	● F020C3LH030	● F020C4LH030	● F020C4LH030	758,00 €		
● F020C1LH033	● F020C2LH033	● F020C3LH033	● F020C4LH033	● F020C4LH033	758,00 €		

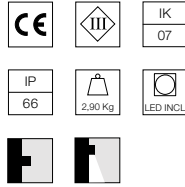
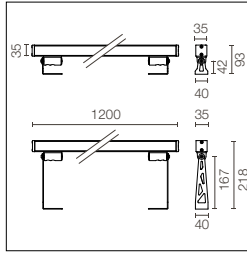

Alimentation électrique à distance 48V et supports d'installation à commander séparément. Verre transparent extra clair, sauf en version DIFFUSE avec verre sablé. Appareils dimmables PWM. Version SMART sur demande (puissance 14W - flux - 50% lm).

48V remote power supply and installation brackets to be ordered separately. Extra clear transparent glass, excluding the DIFFUSE version with sandblasted glass. Dimmable PWM luminaires. SMART version available upon request (power 14W - flux -50% lm).

Power Led: 23W - 2782 lm ≠ *FIXT 2069 lm - 2700K/CRI 80 - 48V /23W - 2881 lm ≠ *FIXT 2142 lm - 3000K/CRI 80 - 48V / 23W - 2981 lm ≠ *FIXT 2216 lm - 4000K/CRI 80 - 48V
 *FIXT lm = Medium Optic

1Standard - Schéma électrique n.1 page 644 / Wiring diagram n.1 page 644

2200K	2700K	3000K	4000K	
○ F020A14H001	○ F020A24H001	○ F020A34H001	○ F020A44H001	793,00 €
● F020A14H006	● F020A24H006	● F020A34H006	● F020A44H006	793,00 €
● F020A14H012	● F020A24H012	● F020A34H012	● F020A44H012	793,00 €
● F020A14H018	● F020A24H018	● F020A34H018	● F020A44H018	793,00 €
● F020A14H030	● F020A24H030	● F020A34H030	● F020A44H030	793,00 €
● F020A14H033	● F020A24H033	● F020A34H033	● F020A44H033	793,00 €

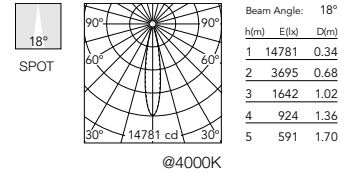

2Quick Install I H₂O Stop Fast Connect - Schéma électrique n.2 page 644 / Wiring diagram n.2 page 644

2200K	2700K	3000K	4000K	
○ F020B14H001	○ F020B24H001	○ F020B34H001	○ F020B44H001	835,00 €
● F020B14H006	● F020B24H006	● F020B34H006	● F020B44H006	835,00 €
● F020B14H012	● F020B24H012	● F020B34H012	● F020B44H012	835,00 €
● F020B14H018	● F020B24H018	● F020B34H018	● F020B44H018	835,00 €
● F020B14H030	● F020B24H030	● F020B34H030	● F020B44H030	835,00 €
● F020B14H033	● F020B24H033	● F020B34H033	● F020B44H033	835,00 €

3Continuous Line I/O H₂O Stop Fast Connect - Schéma électrique n.3 page 644 / Wiring diagram n.3 page 644

2200K	2700K	3000K	4000K	
○ F020C14H001	○ F020C24H001	○ F020C34H001	○ F020C44H001	877,00 €
● F020C14H006	● F020C24H006	● F020C34H006	● F020C44H006	877,00 €
● F020C14H012	● F020C24H012	● F020C34H012	● F020C44H012	877,00 €
● F020C14H018	● F020C24H018	● F020C34H018	● F020C44H018	877,00 €
● F020C14H030	● F020C24H030	● F020C34H030	● F020C44H030	877,00 €
● F020C14H033	● F020C24H033	● F020C34H033	● F020C44H033	877,00 €

1Standard - Schéma électrique n.1 page 644 / Wiring diagram n.1 page 644

2200K	2700K	3000K	4000K	
○ F020A18H001	○ F020A28H001	○ F020A38H001	○ F020A48H001	793,00 €
● F020A18H006	● F020A28H006	● F020A38H006	● F020A48H006	793,00 €
● F020A18H012	● F020A28H012	● F020A38H012	● F020A48H012	793,00 €
● F020A18H018	● F020A28H018	● F020A38H018	● F020A48H018	793,00 €
● F020A18H030	● F020A28H030	● F020A38H030	● F020A48H030	793,00 €
● F020A18H033	● F020A28H033	● F020A38H033	● F020A48H033	793,00 €

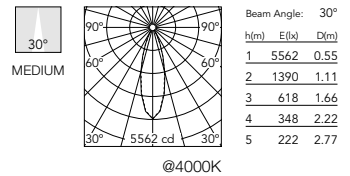

2Quick Install I H₂O Stop Fast Connect - Schéma électrique n.2 page 644 / Wiring diagram n.2 page 644

2200K	2700K	3000K	4000K	
○ F020B18H001	○ F020B28H001	○ F020B38H001	○ F020B48H001	835,00 €
● F020B18H006	● F020B28H006	● F020B38H006	● F020B48H006	835,00 €
● F020B18H012	● F020B28H012	● F020B38H012	● F020B48H012	835,00 €
● F020B18H018	● F020B28H018	● F020B38H018	● F020B48H018	835,00 €
● F020B18H030	● F020B28H030	● F020B38H030	● F020B48H030	835,00 €
● F020B18H033	● F020B28H033	● F020B38H033	● F020B48H033	835,00 €

3Continuous Line I/O H₂O Stop Fast Connect - Schéma électrique n.3 page 644 / Wiring diagram n.3 page 644

2200K	2700K	3000K	4000K	
○ F020C18H001	○ F020C28H001	○ F020C38H001	○ F020C48H001	877,00 €
● F020C18H006	● F020C28H006	● F020C38H006	● F020C48H006	877,00 €
● F020C18H012	● F020C28H012	● F020C38H012	● F020C48H012	877,00 €
● F020C18H018	● F020C28H018	● F020C38H018	● F020C48H018	877,00 €
● F020C18H030	● F020C28H030	● F020C38H030	● F020C48H030	877,00 €
● F020C18H033	● F020C28H033	● F020C38H033	● F020C48H033	877,00 €

*Standard Version: câble en sortie long. 1000 mm (accessoires de connexion à commander séparément) / 1000 mm length prewired cable (connecting accessory to be separately ordered).

2Quick Install In H₂O Stop Version: Connecteur H₂O Stop Plug&Play préinstallé pour connexion rapide (accessoires de connexion à commander séparément) / Prewired H₂O Stop Plug&Play connector for an easy/rapid connection (connecting accessory to be ordered separately).

3Continuous Line In/Out H₂O Stop Version: Connecteurs H₂O Stop Plug&Play préinstallés pour connexion en ligne (accessoires de connexion à commander séparément) / Prewired H₂O Stop Plug&Play connectors for an easy in line connection (connecting accessory to be ordered separately).

1Standard - Schéma électrique n.1 page 644 / Wiring diagram n.1 page 644

2200K		2700K		3000K		4000K	
○ F020A1DH001	○ F020A2DH001	○ F020A3DH001	○ F020A4DH001	○ F020A4DH001	793,00 €		
● F020A1DH006	● F020A2DH006	● F020A3DH006	● F020A4DH006	● F020A4DH006	793,00 €		
● F020A1DH012	● F020A2DH012	● F020A3DH012	● F020A4DH012	● F020A4DH012	793,00 €		
● F020A1DH018	● F020A2DH018	● F020A3DH018	● F020A4DH018	● F020A4DH018	793,00 €		
● F020A1DH030	● F020A2DH030	● F020A3DH030	● F020A4DH030	● F020A4DH030	793,00 €		
● F020A1DH033	● F020A2DH033	● F020A3DH033	● F020A4DH033	● F020A4DH033	793,00 €		



FLOOD

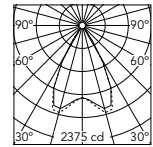

@4000K

Beam Angle: 59°

h(m)	E(ft)	D(m)
1	2375	1.14
2	594	2.28
3	264	3.41
4	148	4.55
5	95	5.69

2Quick Install I H₂O Stop Fast Connect - Schéma électrique n.2 page 644 / Wiring diagram n.2 page 644

2200K		2700K		3000K		4000K	
○ F020B1DH001	○ F020B2DH001	○ F020B3DH001	○ F020B4DH001	○ F020B4DH001	835,00 €		
● F020B1DH006	● F020B2DH006	● F020B3DH006	● F020B4DH006	● F020B4DH006	835,00 €		
● F020B1DH012	● F020B2DH012	● F020B3DH012	● F020B4DH012	● F020B4DH012	835,00 €		
● F020B1DH018	● F020B2DH018	● F020B3DH018	● F020B4DH018	● F020B4DH018	835,00 €		
● F020B1DH030	● F020B2DH030	● F020B3DH030	● F020B4DH030	● F020B4DH030	835,00 €		
● F020B1DH033	● F020B2DH033	● F020B3DH033	● F020B4DH033	● F020B4DH033	835,00 €		

3Continuous Line I/O H₂O Stop Fast Connect - Schéma électrique n.3 page 644 / Wiring diagram n.3 page 644

2200K		2700K		3000K		4000K	
○ F020C1DH001	○ F020C2DH001	○ F020C3DH001	○ F020C4DH001	○ F020C4DH001	877,00 €		
● F020C1DH006	● F020C2DH006	● F020C3DH006	● F020C4DH006	● F020C4DH006	877,00 €		
● F020C1DH012	● F020C2DH012	● F020C3DH012	● F020C4DH012	● F020C4DH012	877,00 €		
● F020C1DH018	● F020C2DH018	● F020C3DH018	● F020C4DH018	● F020C4DH018	877,00 €		
● F020C1DH030	● F020C2DH030	● F020C3DH030	● F020C4DH030	● F020C4DH030	877,00 €		
● F020C1DH033	● F020C2DH033	● F020C3DH033	● F020C4DH033	● F020C4DH033	877,00 €		

1Standard - Schéma électrique n.1 page 644 / Wiring diagram n.1 page 644

2200K		2700K		3000K		4000K	
○ F020A1HH001	○ F020A2HH001	○ F020A3HH001	○ F020A4HH001	○ F020A4HH001	793,00 €		
● F020A1HH006	● F020A2HH006	● F020A3HH006	● F020A4HH006	● F020A4HH006	793,00 €		
● F020A1HH012	● F020A2HH012	● F020A3HH012	● F020A4HH012	● F020A4HH012	793,00 €		
● F020A1HH018	● F020A2HH018	● F020A3HH018	● F020A4HH018	● F020A4HH018	793,00 €		
● F020A1HH030	● F020A2HH030	● F020A3HH030	● F020A4HH030	● F020A4HH030	793,00 €		
● F020A1HH033	● F020A2HH033	● F020A3HH033	● F020A4HH033	● F020A4HH033	793,00 €		



ELLIPTICAL

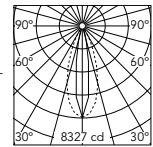

@4000K

Beam Angle: 38°

h(m)	E(ft)	D(m)
1	8327	0.30
2	2082	0.60
3	925	0.90
4	520	1.20
5	333	1.50

2Quick Install I H₂O Stop Fast Connect - Schéma électrique n.2 page 644 / Wiring diagram n.2 page 644

2200K		2700K		3000K		4000K	
○ F020B1HH001	○ F020B2HH001	○ F020B3HH001	○ F020B4HH001	○ F020B4HH001	835,00 €		
● F020B1HH006	● F020B2HH006	● F020B3HH006	● F020B4HH006	● F020B4HH006	835,00 €		
● F020B1HH012	● F020B2HH012	● F020B3HH012	● F020B4HH012	● F020B4HH012	835,00 €		
● F020B1HH018	● F020B2HH018	● F020B3HH018	● F020B4HH018	● F020B4HH018	835,00 €		
● F020B1HH030	● F020B2HH030	● F020B3HH030	● F020B4HH030	● F020B4HH030	835,00 €		
● F020B1HH033	● F020B2HH033	● F020B3HH033	● F020B4HH033	● F020B4HH033	835,00 €		

3Continuous Line I/O H₂O Stop Fast Connect - Schéma électrique n.3 page 644 / Wiring diagram n.3 page 644

2200K		2700K		3000K		4000K	
○ F020C1HH001	○ F020C2HH001	○ F020C3HH001	○ F020C4HH001	○ F020C4HH001	877,00 €		
● F020C1HH006	● F020C2HH006	● F020C3HH006	● F020C4HH006	● F020C4HH006	877,00 €		
● F020C1HH012	● F020C2HH012	● F020C3HH012	● F020C4HH012	● F020C4HH012	877,00 €		
● F020C1HH018	● F020C2HH018	● F020C3HH018	● F020C4HH018	● F020C4HH018	877,00 €		
● F020C1HH030	● F020C2HH030	● F020C3HH030	● F020C4HH030	● F020C4HH030	877,00 €		
● F020C1HH033	● F020C2HH033	● F020C3HH033	● F020C4HH033	● F020C4HH033	877,00 €		

1Standard - Schéma électrique n.1 page 644 / Wiring diagram n.1 page 644

2200K		2700K		3000K		4000K	
○ F020A1MH001	○ F020A2MH001	○ F020A3MH001	○ F020A4MH001	○ F020A4MH001	793,00 €		
● F020A1MH006	● F020A2MH006	● F020A3MH006	● F020A4MH006	● F020A4MH006	793,00 €		
● F020A1MH012	● F020A2MH012	● F020A3MH012	● F020A4MH012	● F020A4MH012	793,00 €		
● F020A1MH018	● F020A2MH018	● F020A3MH018	● F020A4MH018	● F020A4MH018	793,00 €		
● F020A1MH030	● F020A2MH030	● F020A3MH030	● F020A4MH030	● F020A4MH030	793,00 €		
● F020A1MH033	● F020A2MH033	● F020A3MH033	● F020A4MH033	● F020A4MH033	793,00 €		



DIFFUSED

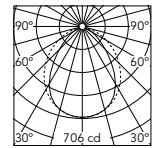

@4000K

Beam Angle: 90°

h(m)	E(ft)	D(m)
1	706	1.67
2	177	3.34
3	78	5.00
4	44	6.67
5	28	8.34

2Quick Install I H₂O Stop Fast Connect - Schéma électrique n.2 page 644 / Wiring diagram n.2 page 644

2200K		2700K		3000K		4000K	
○ F020B1MH001	○ F020B2MH001	○ F020B3MH001	○ F020B4MH001	○ F020B4MH001	835,00 €		
● F020B1MH006	● F020B2MH006	● F020B3MH006	● F020B4MH006	● F020B4MH006	835,00 €		
● F020B1MH012	● F020B2MH012	● F020B3MH012	● F020B4MH012	● F020B4MH012	835,00 €		
● F020B1MH018	● F020B2MH018	● F020B3MH018	● F020B4MH018	● F020B4MH018	835,00 €		
● F020B1MH030	● F020B2MH030	● F020B3MH030	● F020B4MH030	● F020B4MH030	835,00 €		
● F020B1MH033	● F020B2MH033	● F020B3MH033	● F020B4MH033	● F020B4MH033	835,00 €		

3Continuous Line I/O H₂O Stop Fast Connect - Schéma électrique n.3 page 644 / Wiring diagram n.3 page 644

2200K		2700K		3000K		4000K	
○ F020C1MH001	○ F020C2MH001	○ F020C3MH001	○ F020C4MH001	○ F020C4MH001	877,00 €		
● F020C1MH006	● F020C2MH006	● F020C3MH006	● F020C4MH006	● F020C4MH006	877,00 €		
● F020C1MH012	● F020C2MH012	● F020C3MH012	● F020C4MH012	● F020C4MH012	877,00 €		
● F020C1MH018	● F020C2MH018	● F020C3MH018	● F020C4MH018	● F020C4MH018	877,00 €		
● F020C1MH030	● F020C2MH030	● F020C3MH030	● F020C4MH030	● F020C4MH030	877,00 €		
● F020C1MH033	● F020C2MH033	● F020C3MH033	● F020C4MH033	● F020C4MH033	877,00 €		

Outgraze 35 Easy L 300

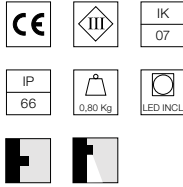
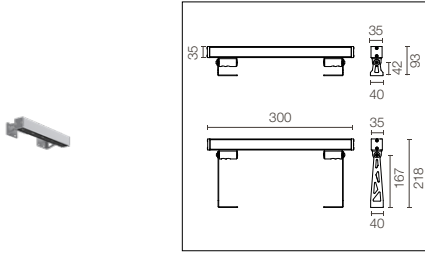

Alimentation électrique à distance 24V et supports d'installation à commander séparément. Appareils dimmables PWM. Verre sablé.

24V remote power supply and installation brackets to be ordered separately. Dimmable PWM luminaires. Sandblasted glass.

Mid-power Led: 4,5W - 454 lm ≠ FIXT 190 lm - 2700K/CRI 80 - 24V / 4,5W - 494 lm ≠ FIXT 207 lm - 3000K/CRI 80 - 24V / 4,5W - 533 lm ≠ FIXT 223 lm - 4000K/CRI 80 - 24V

¹**Standard** - Schéma électrique n.1 page 644 / Wiring diagram n.1 page 644

2700K		3000K		4000K	
○ F020G2JH001	344,00 €	○ F020G3JH001	344,00 €	○ F020G4JH001	344,00 €
● F020G2JH006	344,00 €	● F020G3JH006	344,00 €	● F020G4JH006	344,00 €
● F020G2JH012	344,00 €	● F020G3JH012	344,00 €	● F020G4JH012	344,00 €
● F020G2JH018	344,00 €	● F020G3JH018	344,00 €	● F020G4JH018	344,00 €
● F020G2JH030	344,00 €	● F020G3JH030	344,00 €	● F020G4JH030	344,00 €
● F020G2JH033	344,00 €	● F020G3JH033	344,00 €	● F020G4JH033	344,00 €

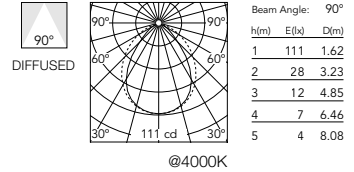

²**Quick Install I H₂O Stop Fast Connect** - Schéma électrique n.2 page 644 / Wiring diagram n.2 page 644

2700K		3000K		4000K	
○ F020H2JH001	386,00 €	○ F020H3JH001	386,00 €	○ F020H4JH001	386,00 €
● F020H2JH006	386,00 €	● F020H3JH006	386,00 €	● F020H4JH006	386,00 €
● F020H2JH012	386,00 €	● F020H3JH012	386,00 €	● F020H4JH012	386,00 €
● F020H2JH018	386,00 €	● F020H3JH018	386,00 €	● F020H4JH018	386,00 €
● F020H2JH030	386,00 €	● F020H3JH030	386,00 €	● F020H4JH030	386,00 €
● F020H2JH033	386,00 €	● F020H3JH033	386,00 €	● F020H4JH033	386,00 €

Outgraze 35 Easy L 300 - Tunable White 2700K÷5700K

Mid-power Led: 4,5W - 227÷286 lm ≠ FIXT 95÷120 lm - 2700K÷5700K/CRI 80 - 2CH x 24V

¹**Tunable White Standard** - Schéma électrique n.4 page 645 / Wiring diagram n.4 page 645

2700K÷5700K	
○ F020GTJH001	374,00 €
● F020GTJH006	374,00 €
● F020GTJH012	374,00 €
● F020GTJH018	374,00 €
● F020GTJH030	374,00 €
● F020GTJH033	374,00 €



²**Tunable White Quick Install I H₂O Stop Fast Connect** - Schéma électrique n.5 page 645 / Wiring diagram n.5 page 645

2700K÷5700K	
○ F020HTJH001	416,00 €
● F020HTJH006	416,00 €
● F020HTJH012	416,00 €
● F020HTJH018	416,00 €
● F020HTJH030	416,00 €
● F020HTJH033	416,00 €

Photometric data on request.

¹Standard Version: câble en sortie long. 1000 mm (accessoires de connexion à commander séparément) / 1000 mm length prewired cable (connecting accessory to be separately ordered).

²Quick Install In H₂O Stop Version: Connecteur H₂O Stop Plug&Play préinstallé pour connexion rapide (accessoires de connexion à commander séparément) / Prewired H₂O Stop Plug&Play connector for an easy/rapid connection (connecting accessory to be ordered separately).

Outgraze 35 Easy L 600

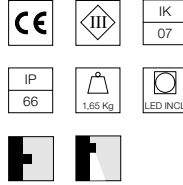
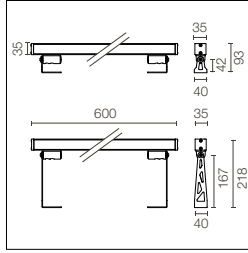

Alimentation électrique à distance 24V et supports d'installation à commander séparément. Appareils dimmables PWM. Verre sablé.

24V remote power supply and installation brackets to be ordered separately. Dimmable PWM luminaires. Sandblasted glass.

Mid-power Led: 9W - 909 lm ≠ FIXT 381 lm - 2700K/CRI 80 - 24V / 9W - 988 lm ≠ FIXT 414 lm - 3000K/CRI 80 - 24V / 9W - 1067 lm ≠ FIXT 447 lm - 4000K/CRI 80 - 24V

¹Standard - Schéma électrique n.1 page 644 / Wiring diagram n.1 page 644

2700K		3000K		4000K	
○ F020G2KH001	446,00 €	○ F020G3KH001	446,00 €	○ F020G4KH001	446,00 €
● F020G2KH006	446,00 €	● F020G3KH006	446,00 €	● F020G4KH006	446,00 €
● F020G2KH012	446,00 €	● F020G3KH012	446,00 €	● F020G4KH012	446,00 €
● F020G2KH018	446,00 €	● F020G3KH018	446,00 €	● F020G4KH018	446,00 €
● F020G2KH030	446,00 €	● F020G3KH030	446,00 €	● F020G4KH030	446,00 €
● F020G2KH033	446,00 €	● F020G3KH033	446,00 €	● F020G4KH033	446,00 €

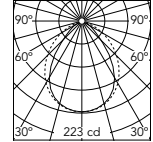

Beam Angle:	90°	
h(m)	E(lx)	D(m)
1	223	1.62
2	56	3.23
3	25	4.85
4	14	6.46
5	9	8.08

@4000K

²Quick Install I H₂O Stop Fast Connect - Schéma électrique n.2 page 644 / Wiring diagram n.2 page 644

2700K		3000K		4000K	
○ F020H2KH001	488,00 €	○ F020H3KH001	488,00 €	○ F020H4KH001	488,00 €
● F020H2KH006	488,00 €	● F020H3KH006	488,00 €	● F020H4KH006	488,00 €
● F020H2KH012	488,00 €	● F020H3KH012	488,00 €	● F020H4KH012	488,00 €
● F020H2KH018	488,00 €	● F020H3KH018	488,00 €	● F020H4KH018	488,00 €
● F020H2KH030	488,00 €	● F020H3KH030	488,00 €	● F020H4KH030	488,00 €
● F020H2KH033	488,00 €	● F020H3KH033	488,00 €	● F020H4KH033	488,00 €

³Continuous Line I/O H₂O Stop Fast Connect - Schéma électrique n.3 page 644 / Wiring diagram n.3 page 644

2700K		3000K		4000K	
○ F020J2KH001	530,00 €	○ F020J3KH001	530,00 €	○ F020J4KH001	530,00 €
● F020J2KH006	530,00 €	● F020J3KH006	530,00 €	● F020J4KH006	530,00 €
● F020J2KH012	530,00 €	● F020J3KH012	530,00 €	● F020J4KH012	530,00 €
● F020J2KH018	530,00 €	● F020J3KH018	530,00 €	● F020J4KH018	530,00 €
● F020J2KH030	530,00 €	● F020J3KH030	530,00 €	● F020J4KH030	530,00 €
● F020J2KH033	530,00 €	● F020J3KH033	530,00 €	● F020J4KH033	530,00 €

Outgraze 35 Easy L 600 - Tunable White 2700K÷5700K

Mid-power Led: 9W - 454÷573 lm ≠ FIXT 190÷240 lm - 2700K÷5700K/CRI 80 - 2CH x 24V

¹Tunable White Standard - Schéma électrique n.4 page 645 / Wiring diagram n.4 page 645

2700K÷5700K	
○ F020GTKH001	481,00 €
● F020GTKH006	481,00 €
● F020GTKH012	481,00 €
● F020GTKH018	481,00 €
● F020GTKH030	481,00 €
● F020GTKH033	481,00 €



²Tunable White Quick Install I H₂O Stop Fast Connect - Schéma électrique n.5 page 645 / Wiring diagram n.5 page 645

2700K÷5700K	
○ F020HTKH001	524,00 €
● F020HTKH006	524,00 €
● F020HTKH012	524,00 €
● F020HTKH018	524,00 €
● F020HTKH030	524,00 €
● F020HTKH033	524,00 €

³Tunable White Continous Line I/O H₂O Stop Fast Connect - Schéma électrique n.6 page 645 / Wiring diagram n.6 page 645

2700K÷5700K	
○ F020JTKH001	566,00 €
● F020JTKH006	566,00 €
● F020JTKH012	566,00 €
● F020JTKH018	566,00 €
● F020JTKH030	566,00 €
● F020JTKH033	566,00 €

Photometric data on request.

¹Standard Version: câble en sortie long. 1000 mm (accessoires de connexion à commander séparément) / 1000 mm length prewired cable (connecting accessory to be separately ordered).

²Quick Install In H₂O Stop Version: Connecteur H₂O Stop Plug&Play préinstallé pour connexion rapide (accessoires de connexion à commander séparément) / Prewired H₂O Stop Plug&Play connector for an easy/rapid connection (connecting accessory to be ordered separately).

³Continuous Line In/Out H₂O Stop Version: Connecteurs H₂O Stop Plug&Play préinstallés pour connexion en ligne (accessoires de connexion à commander séparément) / Prewired H₂O Stop Plug&Play connectors for an easy in line connection (connecting accessory to be ordered separately).

Outgraze 35 Easy L 900

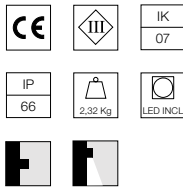
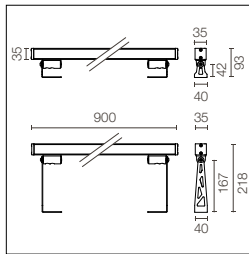

Alimentation électrique à distance 24V et supports d'installation à commander séparément. Appareils dimmables PWM. Verre sablé.

24V remote power supply and installation brackets to be ordered separately. Dimmable PWM luminaires. Sandblasted glass.

Mid-power Led: 13W - 1363 lm ≠ FIXT 571 lm - 2700K/CRI 80 - 24V / 13W - 1481 lm ≠ FIXT 621 lm - 3000K/CRI 80 - 24V / 13W - 1600 lm ≠ FIXT 670 lm - 4000K/CRI 80 - 24V

¹Standard - Schéma électrique n.1 page 644 / Wiring diagram n.1 page 644

2700K		3000K		4000K	
○ F020G2LH001	566,00 €	○ F020G3LH001	566,00 €	○ F020G4LH001	566,00 €
● F020G2LH006	566,00 €	● F020G3LH006	566,00 €	● F020G4LH006	566,00 €
● F020G2LH012	566,00 €	● F020G3LH012	566,00 €	● F020G4LH012	566,00 €
● F020G2LH018	566,00 €	● F020G3LH018	566,00 €	● F020G4LH018	566,00 €
● F020G2LH030	566,00 €	● F020G3LH030	566,00 €	● F020G4LH030	566,00 €
● F020G2LH033	566,00 €	● F020G3LH033	566,00 €	● F020G4LH033	566,00 €

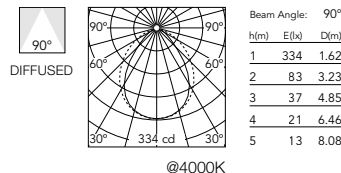

²Quick Install I H₂O Stop Fast Connect - Schéma électrique n.2 page 644 / Wiring diagram n.2 page 644

2700K		3000K		4000K	
○ F020H2LH001	608,00 €	○ F020H3LH001	608,00 €	○ F020H4LH001	608,00 €
● F020H2LH006	608,00 €	● F020H3LH006	608,00 €	● F020H4LH006	608,00 €
● F020H2LH012	608,00 €	● F020H3LH012	608,00 €	● F020H4LH012	608,00 €
● F020H2LH018	608,00 €	● F020H3LH018	608,00 €	● F020H4LH018	608,00 €
● F020H2LH030	608,00 €	● F020H3LH030	608,00 €	● F020H4LH030	608,00 €
● F020H2LH033	608,00 €	● F020H3LH033	608,00 €	● F020H4LH033	608,00 €

³Continuous Line I/O H₂O Stop Fast Connect - Schéma électrique n.3 page 644 / Wiring diagram n.3 page 644

2700K		3000K		4000K	
○ F020J2LH001	650,00 €	○ F020J3LH001	650,00 €	○ F020J4LH001	650,00 €
● F020J2LH006	650,00 €	● F020J3LH006	650,00 €	● F020J4LH006	650,00 €
● F020J2LH012	650,00 €	● F020J3LH012	650,00 €	● F020J4LH012	650,00 €
● F020J2LH018	650,00 €	● F020J3LH018	650,00 €	● F020J4LH018	650,00 €
● F020J2LH030	650,00 €	● F020J3LH030	650,00 €	● F020J4LH030	650,00 €
● F020J2LH033	650,00 €	● F020J3LH033	650,00 €	● F020J4LH033	650,00 €

Outgraze 35 Easy L 900 - Tunable White 2700K÷5700K

Mid-power Led: 13W - 681÷859 lm ≠ FIXT 285÷360 lm - 2700K÷5700K/CRI 80 - 2CH x 24V

¹Tunable White Standard - Schéma électrique n.4 page 645 / Wiring diagram n.4 page 645

2700K÷5700K	
○ F020GTLH001	627,00 €
● F020GTLH006	627,00 €
● F020GTLH012	627,00 €
● F020GTLH018	627,00 €
● F020GTLH030	627,00 €
● F020GTLH033	627,00 €



²Tunable White Quick Install I H₂O Stop Fast Connect - Schéma électrique n.5 page 645 / Wiring diagram n.5 page 645

2700K÷5700K	
○ F020HTLH001	668,00 €
● F020HTLH006	668,00 €
● F020HTLH012	668,00 €
● F020HTLH018	668,00 €
● F020HTLH030	668,00 €
● F020HTLH033	668,00 €

³Tunable White Continuous Line I/O H₂O Stop Fast Connect - Schéma électrique n.6 page 645 / Wiring diagram n.6 page 645

2700K÷5700K	
○ F020JTLH001	709,00 €
● F020JTLH006	709,00 €
● F020JTLH012	709,00 €
● F020JTLH018	709,00 €
● F020JTLH030	709,00 €
● F020JTLH033	709,00 €

Photometric data on request.

¹Standard Version: câble en sortie long. 1000 mm (accessoires de connexion à commander séparément) / 1000 mm length prewired cable (connecting accessory to be separately ordered).

²Quick Install In H₂O Stop Version: Connecteur H₂O Stop Plug&Play préinstallé pour connexion rapide (accessoires de connexion à commander séparément) / Prewired H₂O Stop Plug&Play connector for an easy/rapid connection (connecting accessory to be ordered separately).

³Continuous Line In/Out H₂O Stop Version: Connecteurs H₂O Stop Plug&Play préinstallés pour connexion en ligne (accessoires de connexion à commander séparément) / Prewired H₂O Stop Plug&Play connectors for an easy in line connection (connecting accessory to be ordered separately).

Outgraze 35 Easy L 1200

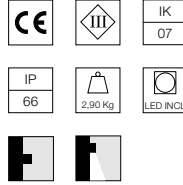
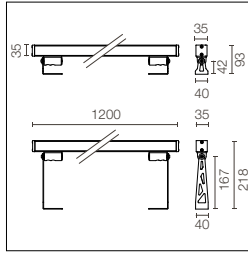
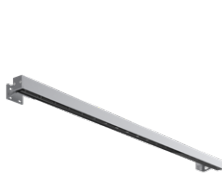

Alimentation électrique à distance 24V et supports d'installation à commander séparément. Appareils dimmables PWM. Verre sablé.

24V remote power supply and installation brackets to be ordered separately. Dimmable PWM luminaires. Sandblasted glass.

Mid-power Led: 17,5W - 1817 lm ≠ FIXT 761 lm - 2700K/CRI 80 - 24V / 17,5W - 1975 lm ≠ FIXT 827 lm - 3000K/CRI 80 - 24V / 17,5W - 2133 lm ≠ FIXT 894 lm - 4000K/CRI 80 - 24V

¹**Standard** - Schéma électrique n.1 page 644 / Wiring diagram n.1 page 644

2700K		3000K		4000K	
○ F020G2MH001	668,00 €	○ F020G3MH001	668,00 €	○ F020G4MH001	668,00 €
● F020G2MH006	668,00 €	● F020G3MH006	668,00 €	● F020G4MH006	668,00 €
● F020G2MH012	668,00 €	● F020G3MH012	668,00 €	● F020G4MH012	668,00 €
● F020G2MH018	668,00 €	● F020G3MH018	668,00 €	● F020G4MH018	668,00 €
● F020G2MH030	668,00 €	● F020G3MH030	668,00 €	● F020G4MH030	668,00 €
● F020G2MH033	668,00 €	● F020G3MH033	668,00 €	● F020G4MH033	668,00 €

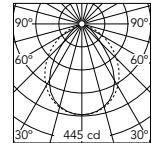

h(m)	E(lx)	D(m)
1	445	1.62
2	111	3.23
3	49	4.85
4	28	6.46
5	18	8.08

@4000K

²**Quick Install I H₂O Stop Fast Connect** - Schéma électrique n.2 page 644 / Wiring diagram n.2 page 644

2700K		3000K		4000K	
○ F020H2MH001	709,00 €	○ F020H3MH001	709,00 €	○ F020H4MH001	709,00 €
● F020H2MH006	709,00 €	● F020H3MH006	709,00 €	● F020H4MH006	709,00 €
● F020H2MH012	709,00 €	● F020H3MH012	709,00 €	● F020H4MH012	709,00 €
● F020H2MH018	709,00 €	● F020H3MH018	709,00 €	● F020H4MH018	709,00 €
● F020H2MH030	709,00 €	● F020H3MH030	709,00 €	● F020H4MH030	709,00 €
● F020H2MH033	709,00 €	● F020H3MH033	709,00 €	● F020H4MH033	709,00 €

³**Continuous Line I/O H₂O Stop Fast Connect** - Schéma électrique n.3 page 644 / Wiring diagram n.3 page 644

2700K		3000K		4000K	
○ F020J2MH001	752,00 €	○ F020J3MH001	752,00 €	○ F020J4MH001	752,00 €
● F020J2MH006	752,00 €	● F020J3MH006	752,00 €	● F020J4MH006	752,00 €
● F020J2MH012	752,00 €	● F020J3MH012	752,00 €	● F020J4MH012	752,00 €
● F020J2MH018	752,00 €	● F020J3MH018	752,00 €	● F020J4MH018	752,00 €
● F020J2MH030	752,00 €	● F020J3MH030	752,00 €	● F020J4MH030	752,00 €
● F020J2MH033	752,00 €	● F020J3MH033	752,00 €	● F020J4MH033	752,00 €

Outgraze 35 Easy L 1200 - Tunable White 2700K÷5700K

Mid-power Led: 17,5W - 909÷1146 lm ≠ FIXT 381÷480 lm - 2700K÷5700K/CRI 80 - 2CH x 24V

¹**Tunable White Standard** - Schéma électrique n.4 page 645 / Wiring diagram n.4 page 645

2700K÷5700K	
○ F020GTMH001	734,00 €
● F020GTMH006	734,00 €
● F020GTMH012	734,00 €
● F020GTMH018	734,00 €
● F020GTMH030	734,00 €
● F020GTMH033	734,00 €



²**Tunable White Quick Install I H₂O Stop Fast Connect** - Schéma électrique n.5 page 645 / Wiring diagram n.5 page 645

2700K÷5700K	
○ F020HTMH001	775,00 €
● F020HTMH006	775,00 €
● F020HTMH012	775,00 €
● F020HTMH018	775,00 €
● F020HTMH030	775,00 €
● F020HTMH033	775,00 €

³**Tunable White Continous Line I/O H₂O Stop Fast Connect** - Schéma électrique n.6 page 645 / Wiring diagram n.6 page 645

2700K÷5700K	
○ F020JTMH001	818,00 €
● F020JTMH006	818,00 €
● F020JTMH012	818,00 €
● F020JTMH018	818,00 €
● F020JTMH030	818,00 €
● F020JTMH033	818,00 €

Photometric data on request.





¹Standard Version: câble en sortie long. 1000 mm (accessoires de connexion à commander séparément) / 1000 mm length prewired cable (connecting accessory to be separately ordered).

²Quick Install In H₂O Stop Version: Connecteur H₂O Stop Plug&Play préinstallé pour connexion rapide (accessoires de connexion à commander séparément) / Prewired H₂O Stop Plug&Play connector for an easy/rapid connection (connecting accessory to be ordered separately).

³Continuous Line In/Out H₂O Stop Version: Connecteurs H₂O Stop Plug&Play préinstallés pour connexion en ligne (accessoires de connexion à commander séparément) / Prewired H₂O Stop Plug&Play connectors for an easy in line connection (connecting accessory to be ordered separately).



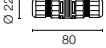

Outgraze 35

Accessoires pour toutes les versions / Accessories for all versions

Jeu de supports courts L 80 mm.	One pair of short brackets L 80 mm.	<ul style="list-style-type: none"> ○ F1203001 41,00 € ● F1203006 41,00 € ● F1203012 41,00 € ● F1203018 41,00 € ● F1203030 41,00 € ● F1203033 41,00 € 			
Jeu de supports longs L 200 mm.	One pair of long brackets L 200 mm.	<ul style="list-style-type: none"> ○ F1204001 59,00 € ● F1204006 59,00 € ● F1204012 59,00 € ● F1204018 59,00 € ● F1204030 59,00 € ● F1204033 59,00 € 			
Système de jonction IP68 H ₂ O Stop anti-condensation à 2 voies 4 pôles. (Ø5,5÷12mm câble).	2 way terminal block 4 poles IP68 H ₂ O Stop. (ø5,5÷12mm cable).	F990C00A000	33,00 €		
Système de jonction IP68 H ₂ O Stop anti-condensation à 3/4 voies 4 pôles. (Ø5,5÷12mm câble).	3/4 way terminal block 4 poles IP68 H ₂ O Stop. (ø5,5÷12mm cable).	F990C010000	60,00 €		

Outgraze 35

Accessoires pour les versions Quick Install I H₂O Stop et Continuous Line I/O H₂O Stop / Accessories for Quick Install I H₂O Stop and Continuous Line I/O H₂O Stop versions

Connecteur 4 pôles Plug&Play.	Plug&play connector 4 poles.	F021Z010000	23,00 €	
Double connecteur 4 pôles Plug&Play + câble L. 600 mm.	Double plug&play connector 4 poles + cable 600 mm length.	F021Z090000	87,00 €	
Connecteur 4 pôles Plug&Play + câble L. 5000 mm.	Plug&play connector 4 poles + cable 5000 mm length.	F021Z100000	116,00 €	
Embout pour connecter panneau (sur l'appareil) 4-5 pôles.	Cap for panel (on the fixtures) plug connector 4-5 poles.	F021Z070000	10,00 €	

Outgraze 35

Interface PWM (Dimmable) pour version 48V / PWM interface (Dimming) for 48V version Alimentation 48V/240V pour interface non comprise, à commander / Power supply 48V/240V for interface not included, to be ordered (cod.RF25753 or cod.RF25746)

Interface de contrôle 48V PWM - DALI IP20 Class III. Vin 48Vdc 120W. (Alimentation non comprise).	Control interface 48V PWM - DALI IP20 Class III. Vin 48Vdc 120W. (Power supply not included).	F990B08A000	92,00 €	
Interface de contrôle 48V PWM - 1-10V IP20 Class III. Vin 48Vdc 120W. (Alimentation non comprise).	Control interface 48V PWM - 1-10V IP20 Class III. Vin 48Vdc 120W. (Power supply not included).	F990B15A000	92,00 €	

Outgraze 35

Alimentation pour version 48V / Power supply for 48V version

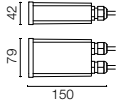
Équipement d'alimentation 48V 60W / 110-240V IP67 Classe II selv eq.	Power supply 48V 60W / 110-240V IP67 Class II selv eq.	RF25753	180,00 €		
Équipement d'alimentation 48V 240W / 110-240V single output DIN RAIL.	Power supply 48V 240W / 110-240V single output DIN RAIL.	RF25746	308,00 €		

* Nombre maximum de luminaires par source d'alimentation / Maximum number of luminaires per power supply.

Nombre maximum de luminaires par source d'alimentation (220-240 V). Ces données doivent être vérifiées en prenant en compte les conditions spécifiques d'installation.	Maximum number of luminaires per power supply. (220-240 V). These data must be checked taking into account the specific installation conditions.		L 300	L 600	L 900	L 1200
		Acc. RF25753	8	4	2	2
		Acc. RF25746	32	16	10	8

Outgraze 35

Interface PWM (Dimmable) pour version 24V/ PWM interface (Dimming) for 24V version Alimentation 24V/240V pour interface non comprise, à commander / Power supply 24V/240V for interface not included, to be ordered (cod.F990B28A000, cod.F990B27A000 or cod.F990B29A000)

Interface de contrôle 24V PWM - Dali IP20 Class III. Vin 24Vdc 120W. (Alimentation non comprise).	Control linterface 24V PWM - Dali IP20 Class III. Vin 24Vdc 120W. (Power supply not included).	F990B07A000	92,00 €		
Interface de contrôle 24V PWM - 1-10V IP20 Class III. Vin 24Vdc 120W. (Alimentation non comprise).	Control linterface 24V PWM - 1-10V IP20 Class III. Vin 24Vdc 120W. (Power supply not included).	F990B14A000	92,00 €		

Outgraze 35

Interface PWM pour version 24V Tunable White / PWM interface for 24V Tunable White version Alimentation 24V/240V pour interface non comprise, à commander / Power supply 24V/240V for interface not included, to be ordered (cod.F990B28A000, cod.F990B27A000 or cod.F990B29A000)

Interface de contrôle 24V PWM 2CH - Dali IP20 Class III. Vin 24Vdc 90W. (Alimentation non comprise).	Control linterface 24V PWM 2CH - Dali IP20 Class III. Vin 24Vdc 90W. (Power supply not included).	F990B09A000	215,00 €		
--	---	-------------	----------	---	--

Outgraze 35

Alimentation pour version 24V / Power supply for 24V version

Équipement d'alimentation pour installation à distance 24V DC 50W / 120-240V IP67 Classe II selv.	Power supply for remote installation 24V DC 50W / 120-240V IP67 Class II selv.	*F990B28A000	251,00 €		
Équipement d'alimentation pour installation à distance 24V DC 70W / 220-240V IP67 Classe II selv.	Power supply for remote installation 24V DC 70W / 220-240V IP67 Class II selv.	*F990B27A000	212,00 €		
Équipement d'alimentation pour installation à distance 24V DC 96W / 120-240V IP67 Classe II selv.	Power supply for remote installation 24V DC 96W / 120-240V IP67 Class II selv.	*F990B29A000	300,00 €		

* Nombre maximum de luminaires par source d'alimentation / Maximum number of luminaires per power supply.

Nombre maximum de luminaires par source d'alimentation (220-240 V). Ces données doivent être vérifiées en prenant en compte les conditions spécifiques d'installation.	Maximum number of luminaires per power supply. (220-240 V). These data must be checked taking into account the specific installation conditions.		L 300	L 600	L 900	L 1200
		Acc. F990B28A000	6	3	2	2
		Acc. F990B27A000	8	5	3	3
		Acc. F990B29A000	12	6	4	3

Outgraze 35

48V versions

Schéma électrique n.1 / Wiring diagram n.1

Standard: câble en sortie long. 1000 mm (accessoires de connexion à commander séparément) / 1000 mm length prewired cable (connecting accessory to be separately ordered)



Schéma électrique n.2 / Wiring diagram n.2

Quick Install I H₂O Stop Fast Connect: connecteur H₂O Stop Plug&Play préinstallé pour connexion rapide (accessoires de connexion à commander séparément) / Prewired H₂O Stop Plug&Play connector for an easy/rapid connection (connecting accessory to be ordered separately)

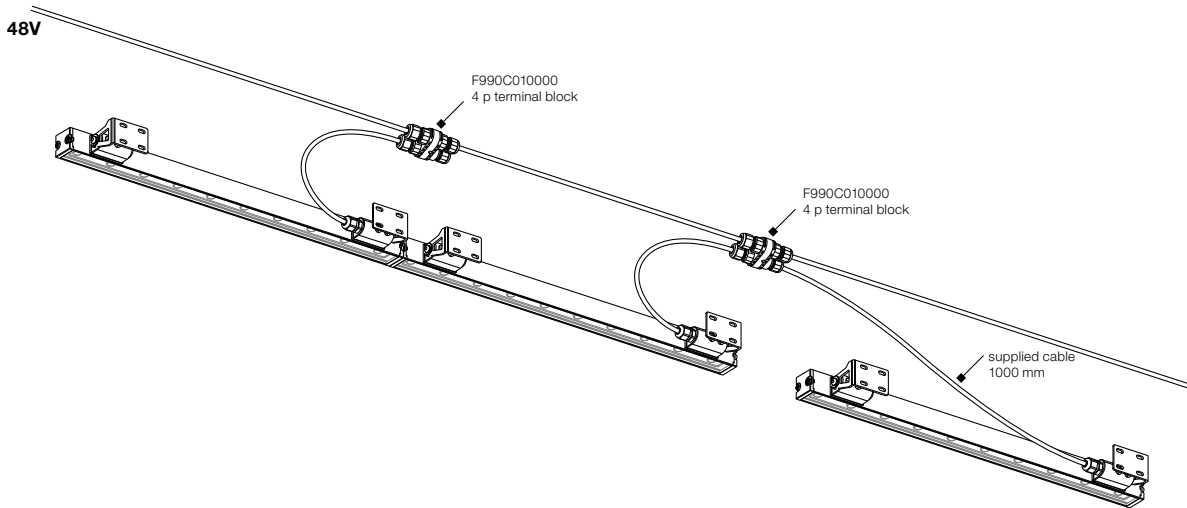

Schéma électrique n.3 / Wiring diagram n.3

Continous Line I/O H₂O Stop Fast Connect: connecteurs H₂O Stop Plug&Play préinstallés pour connexion en ligne (accessoires de connexion à commander séparément) / Prewired H₂O Stop Plug&Play connectors for an easy in line connection (connecting accessory to be ordered separately)

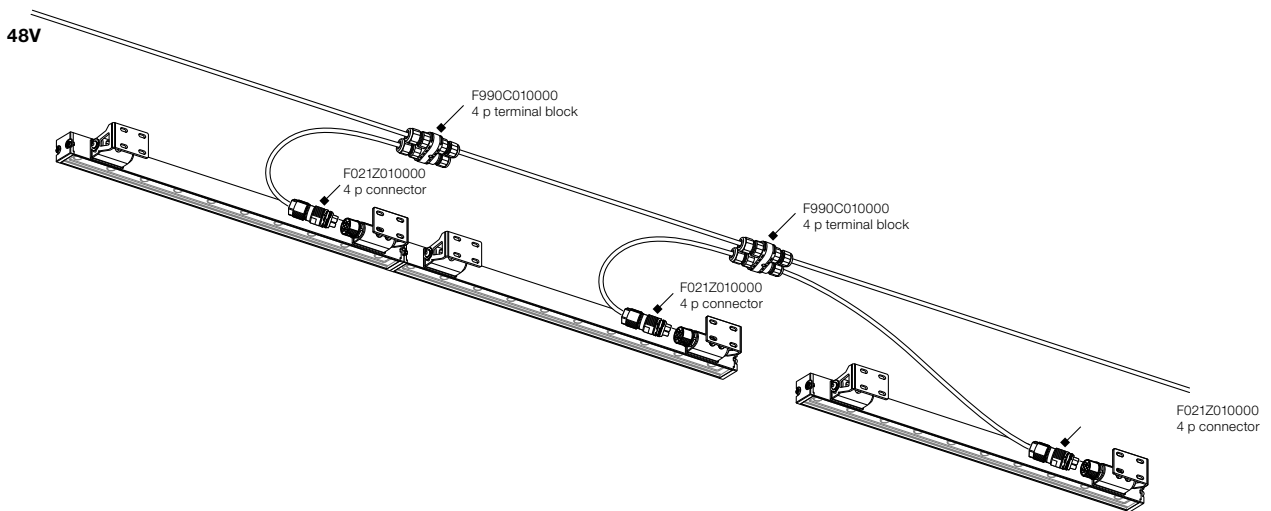
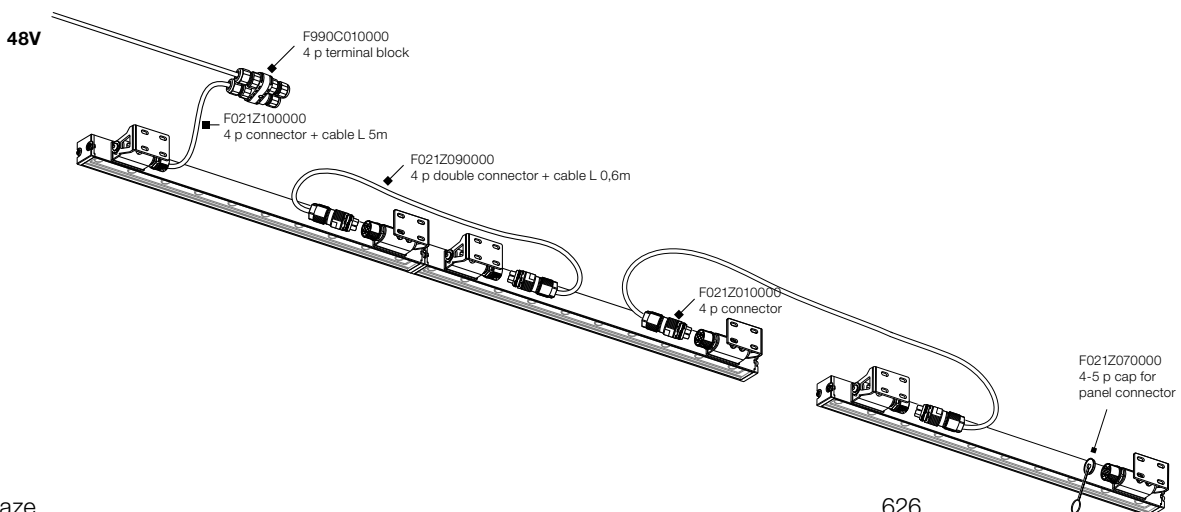

Outgraze 35

24V (Easy) and Tunable White versions

Schéma électrique n.4 / Wiring diagram n.4

Standard: câble en sortie long. 1000 mm (accessoires de connexion à commander séparément) / 1000 mm lenght prewired cable (connecting accessory to be separately ordered)



Schéma électrique n.5 / Wiring diagram n.5

Quick Install I H₂O Stop Fast Connect: connecteur H₂O Stop Plug&Play préinstallé pour connexion rapide (accessoires de connexion à commander séparément) / Prewired H₂O Stop Plug&Play connector for an easy/rapid connection (connecting accessory to be ordered separately)

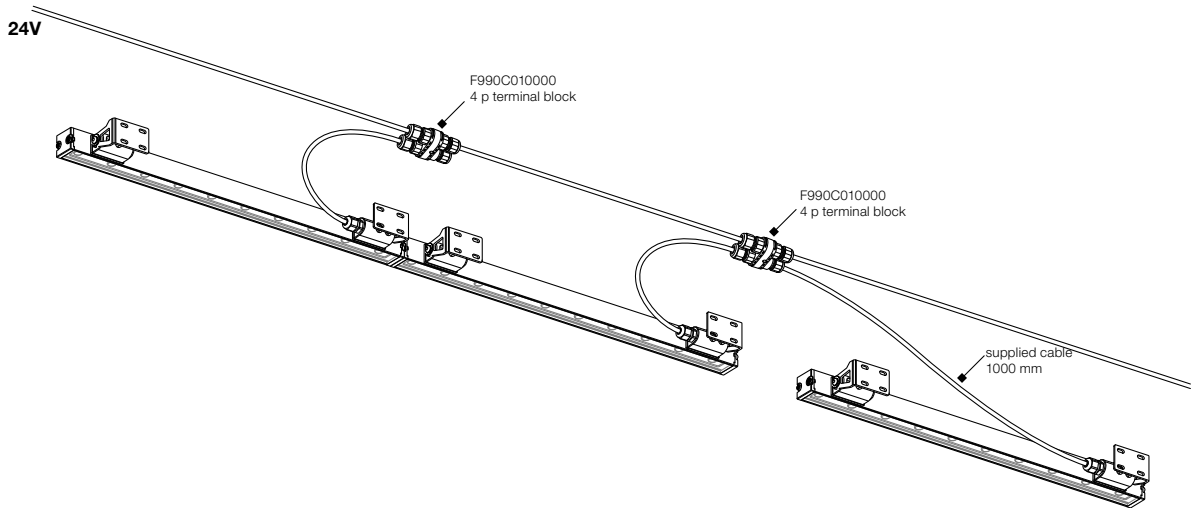

Schéma électrique n.6 / Wiring diagram n.6

Continous Line I/O H₂O Stop Fast Connect: connecteurs H₂O Stop Plug&Play préinstallés pour connexion en ligne (accessoires de connexion à commander séparément) / Prewired H₂O Stop Plug&Play connectors for an easy in line connection (connecting accessory to be ordered separately)



Outgraze 50 L 300 - Non Dimmable

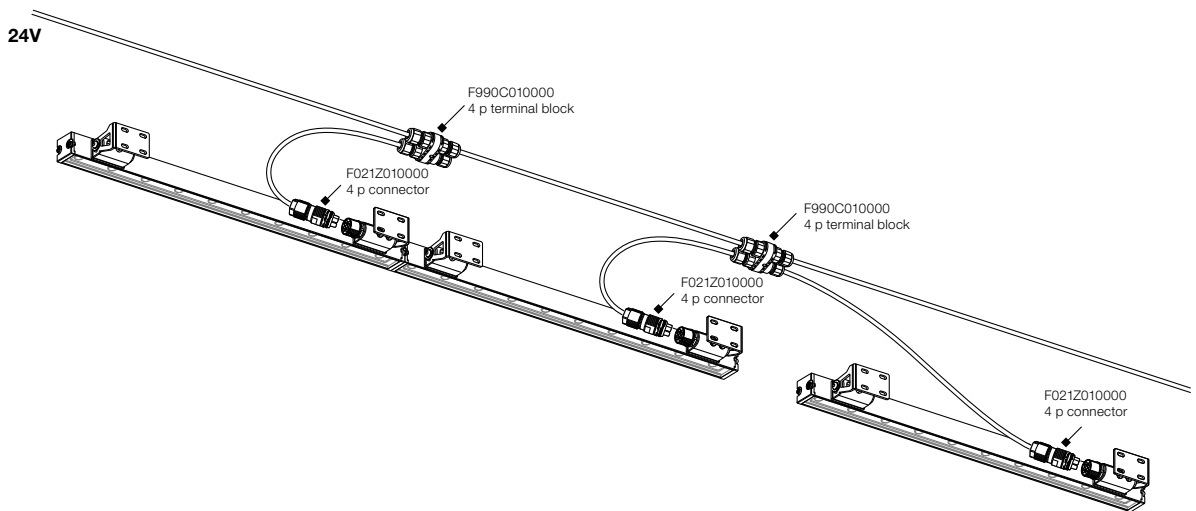
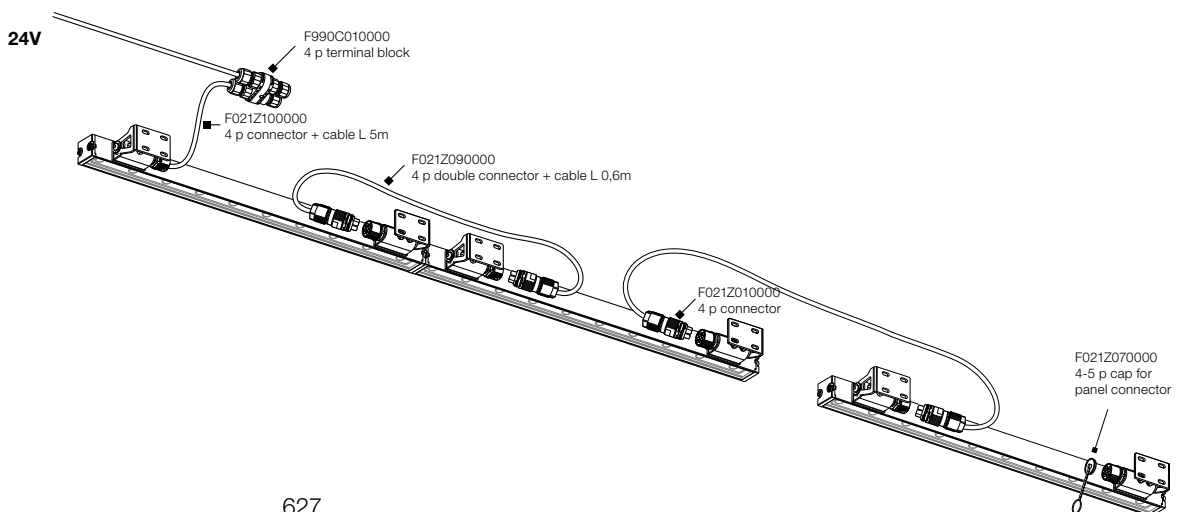
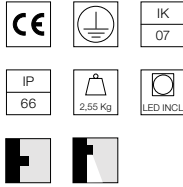
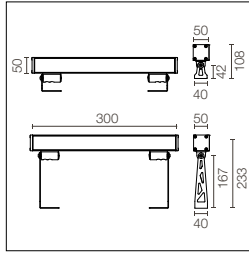

Alimentation 220/240V intégrée.
 Supports d'installation à commander séparément. Verre transparent extra clair, sauf en version DIFFUSE avec verre sablé.
 Version SMART sur demande (puissance 6W - flux - 30% lm).

Integrated 220/240V power supply. Installation brackets, to be ordered separately. Extra clear transparent glass, excluding the DIFFUSE version with sandblasted glass. SMART version available upon request (power 6W-flux-30% lm).

Power Led: 8W - 835 lm ≠ *FIXT 685 lm - 2700K/CRI 80 - 220-240V / 8W - 864 lm ≠ *FIXT 709 lm - 3000K/CRI 80 - 220-240V / 8W - 894 lm ≠ *FIXT 734 lm - 4000K/CRI 80 - 220-240V / *FIXT lm = Medium Optic

1Standard - Schéma électrique n.7 page 669 / Wiring diagram n.7 page 669

2200K	2700K	3000K	4000K	
○ F021A11A001	○ F021A21A001	○ F021A31A001	○ F021A41A001	440,00 €
● F021A11A006	● F021A21A006	● F021A31A006	● F021A41A006	440,00 €
● F021A11A012	● F021A21A012	● F021A31A012	● F021A41A012	440,00 €
● F021A11A018	● F021A21A018	● F021A31A018	● F021A41A018	440,00 €
● F021A11A030	● F021A21A030	● F021A31A030	● F021A41A030	440,00 €
● F021A11A033	● F021A21A033	● F021A31A033	● F021A41A033	440,00 €

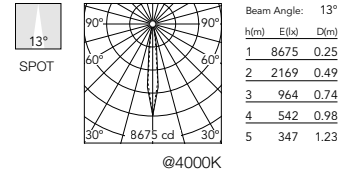

2Quick Install I H₂O Stop Fast Connect - Schéma électrique n.8 page 669 / Wiring diagram n.8 page 669

2200K	2700K	3000K	4000K	
○ F021B11A001	○ F021B21A001	○ F021B31A001	○ F021B41A001	481,00 €
● F021B11A006	● F021B21A006	● F021B31A006	● F021B41A006	481,00 €
● F021B11A012	● F021B21A012	● F021B31A012	● F021B41A012	481,00 €
● F021B11A018	● F021B21A018	● F021B31A018	● F021B41A018	481,00 €
● F021B11A030	● F021B21A030	● F021B31A030	● F021B41A030	481,00 €
● F021B11A033	● F021B21A033	● F021B31A033	● F021B41A033	481,00 €

1Standard - Schéma électrique n.7 page 669 / Wiring diagram n.7 page 669

2200K	2700K	3000K	4000K	
○ F021A15A001	○ F021A25A001	○ F021A35A001	○ F021A45A001	440,00 €
● F021A15A006	● F021A25A006	● F021A35A006	● F021A45A006	440,00 €
● F021A15A012	● F021A25A012	● F021A35A012	● F021A45A012	440,00 €
● F021A15A018	● F021A25A018	● F021A35A018	● F021A45A018	440,00 €
● F021A15A030	● F021A25A030	● F021A35A030	● F021A45A030	440,00 €
● F021A15A033	● F021A25A033	● F021A35A033	● F021A45A033	440,00 €

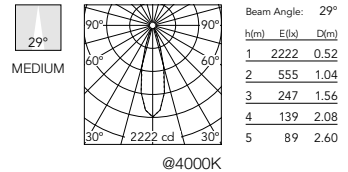

2Quick Install I H₂O Stop Fast Connect - Schéma électrique n.8 page 669 / Wiring diagram n.8 page 669

2200K	2700K	3000K	4000K	
○ F021B15A001	○ F021B25A001	○ F021B35A001	○ F021B45A001	481,00 €
● F021B15A006	● F021B25A006	● F021B35A006	● F021B45A006	481,00 €
● F021B15A012	● F021B25A012	● F021B35A012	● F021B45A012	481,00 €
● F021B15A018	● F021B25A018	● F021B35A018	● F021B45A018	481,00 €
● F021B15A030	● F021B25A030	● F021B35A030	● F021B45A030	481,00 €
● F021B15A033	● F021B25A033	● F021B35A033	● F021B45A033	481,00 €

1Standard - Schéma électrique n.7 page 669 / Wiring diagram n.7 page 669

2200K	2700K	3000K	4000K	
○ F021A1AA001	○ F021A2AA001	○ F021A3AA001	○ F021A4AA001	440,00 €
● F021A1AA006	● F021A2AA006	● F021A3AA006	● F021A4AA006	440,00 €
● F021A1AA012	● F021A2AA012	● F021A3AA012	● F021A4AA012	440,00 €
● F021A1AA018	● F021A2AA018	● F021A3AA018	● F021A4AA018	440,00 €
● F021A1AA030	● F021A2AA030	● F021A3AA030	● F021A4AA030	440,00 €
● F021A1AA033	● F021A2AA033	● F021A3AA033	● F021A4AA033	440,00 €

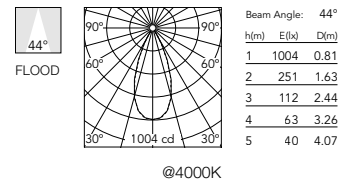

2Quick Install I H₂O Stop Fast Connect - Schéma électrique n.8 page 669 / Wiring diagram n.8 page 669

2200K	2700K	3000K	4000K	
○ F021B1AA001	○ F021B2AA001	○ F021B3AA001	○ F021B4AA001	481,00 €
● F021B1AA006	● F021B2AA006	● F021B3AA006	● F021B4AA006	481,00 €
● F021B1AA012	● F021B2AA012	● F021B3AA012	● F021B4AA012	481,00 €
● F021B1AA018	● F021B2AA018	● F021B3AA018	● F021B4AA018	481,00 €
● F021B1AA030	● F021B2AA030	● F021B3AA030	● F021B4AA030	481,00 €
● F021B1AA033	● F021B2AA033	● F021B3AA033	● F021B4AA033	481,00 €

*Standard Version: câble en sortie long. 1000 mm (accessoires de connexion à commander séparément) / 1000 mm length wired cable (connecting accessory to be separately ordered).

*Quick Install In H₂O Stop Version: Connecteur H₂O Stop Plug&Play préinstallé pour connexion rapide (accessoires de connexion à commander séparément) / Prewired H₂O Stop Plug&Play connector for an easy/rapid connection (connecting accessory to be ordered separately).

1Standard - Schéma électrique n.7 page 669 / Wiring diagram n.7 page 669

2200K		2700K		3000K		4000K	
○ F021A1EA001	○ F021A2EA001	○ F021A3EA001	○ F021A4EA001	○ F021A4EA001	440,00 €		
● F021A1EA006	● F021A2EA006	● F021A3EA006	● F021A4EA006	● F021A4EA006	440,00 €		
● F021A1EA012	● F021A2EA012	● F021A3EA012	● F021A4EA012	● F021A4EA012	440,00 €		
● F021A1EA018	● F021A2EA018	● F021A3EA018	● F021A4EA018	● F021A4EA018	440,00 €		
● F021A1EA030	● F021A2EA030	● F021A3EA030	● F021A4EA030	● F021A4EA030	440,00 €		
● F021A1EA033	● F021A2EA033	● F021A3EA033	● F021A4EA033	● F021A4EA033	440,00 €		

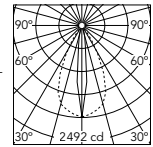

Beam Angle: 53°

h(m)	E(lx)	D(m)
1	2492	0.22
2	623	0.44
3	277	0.66
4	156	0.88
5	100	1.10

@4000K

2Quick Install I H₂O Stop Fast Connect - Schéma électrique n.8 page 669 / Wiring diagram n.8 page 669

2200K		2700K		3000K		4000K	
○ F021B1EA001	○ F021B2EA001	○ F021B3EA001	○ F021B4EA001	○ F021B4EA001	481,00 €		
● F021B1EA006	● F021B2EA006	● F021B3EA006	● F021B4EA006	● F021B4EA006	481,00 €		
● F021B1EA012	● F021B2EA012	● F021B3EA012	● F021B4EA012	● F021B4EA012	481,00 €		
● F021B1EA018	● F021B2EA018	● F021B3EA018	● F021B4EA018	● F021B4EA018	481,00 €		
● F021B1EA030	● F021B2EA030	● F021B3EA030	● F021B4EA030	● F021B4EA030	481,00 €		
● F021B1EA033	● F021B2EA033	● F021B3EA033	● F021B4EA033	● F021B4EA033	481,00 €		

1Standard - Schéma électrique n.7 page 669 / Wiring diagram n.7 page 669

2200K		2700K		3000K		4000K	
○ F021A1JA001	○ F021A2JA001	○ F021A3JA001	○ F021A4JA001	○ F021A4JA001	440,00 €		
● F021A1JA006	● F021A2JA006	● F021A3JA006	● F021A4JA006	● F021A4JA006	440,00 €		
● F021A1JA012	● F021A2JA012	● F021A3JA012	● F021A4JA012	● F021A4JA012	440,00 €		
● F021A1JA018	● F021A2JA018	● F021A3JA018	● F021A4JA018	● F021A4JA018	440,00 €		
● F021A1JA030	● F021A2JA030	● F021A3JA030	● F021A4JA030	● F021A4JA030	440,00 €		
● F021A1JA033	● F021A2JA033	● F021A3JA033	● F021A4JA033	● F021A4JA033	440,00 €		

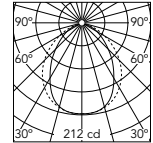

Beam Angle: 90°

h(m)	E(lx)	D(m)
1	212	1.74
2	53	3.49
3	24	5.23
4	13	6.98
5	8	8.72

@4000K

2Quick Install I H₂O Stop Fast Connect - Schéma électrique n.8 page 669 / Wiring diagram n.8 page 669

2200K		2700K		3000K		4000K	
○ F021B1JA001	○ F021B2JA001	○ F021B3JA001	○ F021B4JA001	○ F021B4JA001	481,00 €		
● F021B1JA006	● F021B2JA006	● F021B3JA006	● F021B4JA006	● F021B4JA006	481,00 €		
● F021B1JA012	● F021B2JA012	● F021B3JA012	● F021B4JA012	● F021B4JA012	481,00 €		
● F021B1JA018	● F021B2JA018	● F021B3JA018	● F021B4JA018	● F021B4JA018	481,00 €		
● F021B1JA030	● F021B2JA030	● F021B3JA030	● F021B4JA030	● F021B4JA030	481,00 €		
● F021B1JA033	● F021B2JA033	● F021B3JA033	● F021B4JA033	● F021B4JA033	481,00 €		

Outgraze 50 L 600 - Non Dimmable

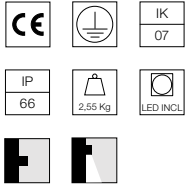
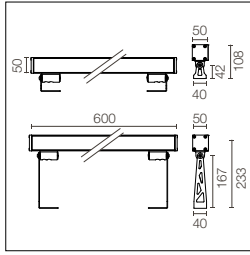

Alimentation 220/240V intégrée.
Supports d'installation à commander séparément. Verre transparent extra clair, sauf en version DIFFUSE avec verre sablé.
Version SMART sur demande (puissance 10,5W - flux -30% lm).

Integrated 220/240V power supply. Installation brackets, to be ordered separately. Extra clear transparent glass, excluding the DIFFUSE version with sandblasted glass. SMART version available upon request (power 10,5W - flux -30% lm).

Power Led: 14,5W - 1669 lm ≠ *FIXT 1369 lm - 2700K/CRI 80 - 220-240V / 14,5W - 1729 lm ≠ *FIXT 1418 lm - 3000K/CRI 80 - 220-240V / 14,5W - 1788 lm ≠ *FIXT 1467 lm - 4000K/CRI 80 - 220-240V
*FIXT lm = Medium Optic

1Standard - Schéma électrique n.7 page 669 / Wiring diagram n.7 page 669

2200K	2700K	3000K	4000K	
○ F021A12A001	○ F021A22A001	○ F021A32A001	○ F021A42A001	530,00 €
● F021A12A006	● F021A22A006	● F021A32A006	● F021A42A006	530,00 €
● F021A12A012	● F021A22A012	● F021A32A012	● F021A42A012	530,00 €
● F021A12A018	● F021A22A018	● F021A32A018	● F021A42A018	530,00 €
● F021A12A030	● F021A22A030	● F021A32A030	● F021A42A030	530,00 €
● F021A12A033	● F021A22A033	● F021A32A033	● F021A42A033	530,00 €

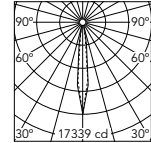

Beam Angle: 13°

h(m)	E(lx)	D(m)
1	17339	0.25
2	4335	0.49
3	1927	0.74
4	1084	0.98
5	694	1.23

@4000K

2Quick Install I H₂O Stop Fast Connect - Schéma électrique n.8 page 669 / Wiring diagram n.8 page 669

2200K	2700K	3000K	4000K	
○ F021B12A001	○ F021B22A001	○ F021B32A001	○ F021B42A001	572,00 €
● F021B12A006	● F021B22A006	● F021B32A006	● F021B42A006	572,00 €
● F021B12A012	● F021B22A012	● F021B32A012	● F021B42A012	572,00 €
● F021B12A018	● F021B22A018	● F021B32A018	● F021B42A018	572,00 €
● F021B12A030	● F021B22A030	● F021B32A030	● F021B42A030	572,00 €
● F021B12A033	● F021B22A033	● F021B32A033	● F021B42A033	572,00 €

3Continuous Line I/O H₂O Stop Fast Connect - Schéma électrique n.9 page 669 / Wiring diagram n.9 page 669

2200K	2700K	3000K	4000K	
○ F021C12A001	○ F021C22A001	○ F021C32A001	○ F021C42A001	615,00 €
● F021C12A006	● F021C22A006	● F021C32A006	● F021C42A006	615,00 €
● F021C12A012	● F021C22A012	● F021C32A012	● F021C42A012	615,00 €
● F021C12A018	● F021C22A018	● F021C32A018	● F021C42A018	615,00 €
● F021C12A030	● F021C22A030	● F021C32A030	● F021C42A030	615,00 €
● F021C12A033	● F021C22A033	● F021C32A033	● F021C42A033	615,00 €

1Standard - Schéma électrique n.7 page 669 / Wiring diagram n.7 page 669

2200K	2700K	3000K	4000K	
○ F021A16A001	○ F021A26A001	○ F021A36A001	○ F021A46A001	530,00 €
● F021A16A006	● F021A26A006	● F021A36A006	● F021A46A006	530,00 €
● F021A16A012	● F021A26A012	● F021A36A012	● F021A46A012	530,00 €
● F021A16A018	● F021A26A018	● F021A36A018	● F021A46A018	530,00 €
● F021A16A030	● F021A26A030	● F021A36A030	● F021A46A030	530,00 €
● F021A16A033	● F021A26A033	● F021A36A033	● F021A46A033	530,00 €

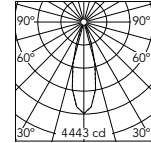

Beam Angle: 29°

h(m)	E(lx)	D(m)
1	4443	0.52
2	1111	1.04
3	494	1.56
4	278	2.08
5	178	2.60

@4000K

2Quick Install I H₂O Stop Fast Connect - Schéma électrique n.8 page 669 / Wiring diagram n.8 page 669

2200K	2700K	3000K	4000K	
○ F021B16A001	○ F021B26A001	○ F021B36A001	○ F021B46A001	572,00 €
● F021B16A006	● F021B26A006	● F021B36A006	● F021B46A006	572,00 €
● F021B16A012	● F021B26A012	● F021B36A012	● F021B46A012	572,00 €
● F021B16A018	● F021B26A018	● F021B36A018	● F021B46A018	572,00 €
● F021B16A030	● F021B26A030	● F021B36A030	● F021B46A030	572,00 €
● F021B16A033	● F021B26A033	● F021B36A033	● F021B46A033	572,00 €

3Continuous Line I/O H₂O Stop Fast Connect - Schéma électrique n.9 page 669 / Wiring diagram n.9 page 669

2200K	2700K	3000K	4000K	
○ F021C16A001	○ F021C26A001	○ F021C36A001	○ F021C46A001	615,00 €
● F021C16A006	● F021C26A006	● F021C36A006	● F021C46A006	615,00 €
● F021C16A012	● F021C26A012	● F021C36A012	● F021C46A012	615,00 €
● F021C16A018	● F021C26A018	● F021C36A018	● F021C46A018	615,00 €
● F021C16A030	● F021C26A030	● F021C36A030	● F021C46A030	615,00 €
● F021C16A033	● F021C26A033	● F021C36A033	● F021C46A033	615,00 €

*Standard Version: câble en sortie long. 1000 mm (accessoires de connexion à commander séparément) / 1000 mm length prewired cable (connecting accessory to be separately ordered).

2Quick Install In H₂O Stop Version: Connecteur H₂O Stop Plug&Play préinstallé pour connexion rapide (accessoires de connexion à commander séparément) / Prewired H₂O Stop Plug&Play connector for an easy/rapid connection (connecting accessory to be ordered separately).

3Continuous Line In/Out H₂O Stop Version: Connecteurs H₂O Stop Plug&Play préinstallés pour connexion en ligne (accessoires de connexion à commander séparément) / Prewired H₂O Stop Plug&Play connectors for an easy in line connection (connecting accessory to be ordered separately).

Outgraze 50 L 900 - Non Dimmable

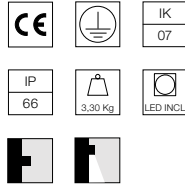
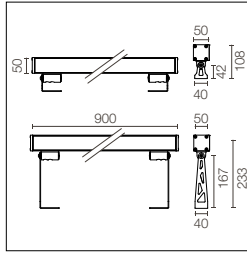

Alimentation 220/240V intégrée.
Supports d'installation à commander séparément. Verre transparent extra clair, sauf en version DIFFUSE avec verre sablé.
Version SMART sur demande (puissance 15,5W-flux-30% lm).

Integrated 220/240V power supply. Installation brackets, to be ordered separately. Extra clear transparent glass, excluding the DIFFUSE version with sandblasted glass. SMART version available upon request (power 15,5W - flux -30% lm).

Power Led: 20W - 2504 lm ≠ *FIXT 2054 lm - 2700K/CRI 80 - 220-240V / 20W - 2593 lm ≠ *FIXT 2127 lm - 3000K/CRI 80 - 220-240V / 20W - 2683 lm ≠ *FIXT 2201 lm - 4000K/CRI 80 - 220-240V
*FIXT lm = Medium Optic

1Standard - Schéma électrique n.7 page 669 / Wiring diagram n.7 page 669

2200K	2700K	3000K	4000K		
○ F021A13A001	○ F021A23A001	○ F021A33A001	○ F021A43A001	697,00 €	
● F021A13A006	● F021A23A006	● F021A33A006	● F021A43A006	697,00 €	
● F021A13A012	● F021A23A012	● F021A33A012	● F021A43A012	697,00 €	
● F021A13A018	● F021A23A018	● F021A33A018	● F021A43A018	697,00 €	
● F021A13A030	● F021A23A030	● F021A33A030	● F021A43A030	697,00 €	
● F021A13A033	● F021A23A033	● F021A33A033	● F021A43A033	697,00 €	

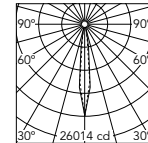

Beam Angle: 13°

h(m)	E(lx)	D(m)
1	26014	0.25
2	6504	0.49
3	2890	0.74
4	1626	0.98
5	1041	1.23

@4000K

2Quick Install I H₂O Stop Fast Connect - Schéma électrique n.8 page 669 / Wiring diagram n.8 page 669

2200K	2700K	3000K	4000K		
○ F021B13A001	○ F021B23A001	○ F021B33A001	○ F021B43A001	740,00 €	
● F021B13A006	● F021B23A006	● F021B33A006	● F021B43A006	740,00 €	
● F021B13A012	● F021B23A012	● F021B33A012	● F021B43A012	740,00 €	
● F021B13A018	● F021B23A018	● F021B33A018	● F021B43A018	740,00 €	
● F021B13A030	● F021B23A030	● F021B33A030	● F021B43A030	740,00 €	
● F021B13A033	● F021B23A033	● F021B33A033	● F021B43A033	740,00 €	

3Continuous Line I/O H₂O Stop Fast Connect - Schéma électrique n.9 page 669 / Wiring diagram n.9 page 669

2200K	2700K	3000K	4000K		
○ F021C13A001	○ F021C23A001	○ F021C33A001	○ F021C43A001	781,00 €	
● F021C13A006	● F021C23A006	● F021C33A006	● F021C43A006	781,00 €	
● F021C13A012	● F021C23A012	● F021C33A012	● F021C43A012	781,00 €	
● F021C13A018	● F021C23A018	● F021C33A018	● F021C43A018	781,00 €	
● F021C13A030	● F021C23A030	● F021C33A030	● F021C43A030	781,00 €	
● F021C13A033	● F021C23A033	● F021C33A033	● F021C43A033	781,00 €	

1Standard - Schéma électrique n.7 page 669 / Wiring diagram n.7 page 669

2200K	2700K	3000K	4000K		
○ F021A17A001	○ F021A27A001	○ F021A37A001	○ F021A47A001	697,00 €	
● F021A17A006	● F021A27A006	● F021A37A006	● F021A47A006	697,00 €	
● F021A17A012	● F021A27A012	● F021A37A012	● F021A47A012	697,00 €	
● F021A17A018	● F021A27A018	● F021A37A018	● F021A47A018	697,00 €	
● F021A17A030	● F021A27A030	● F021A37A030	● F021A47A030	697,00 €	
● F021A17A033	● F021A27A033	● F021A37A033	● F021A47A033	697,00 €	

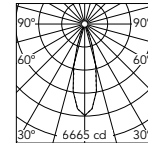

Beam Angle: 29°

h(m)	E(lx)	D(m)
1	6665	0.52
2	1666	1.04
3	741	1.56
4	417	2.08
5	267	2.60

@4000K

2Quick Install I H₂O Stop Fast Connect - Schéma électrique n.8 page 669 / Wiring diagram n.8 page 669

2200K	2700K	3000K	4000K		
○ F021B17A001	○ F021B27A001	○ F021B37A001	○ F021B47A001	740,00 €	
● F021B17A006	● F021B27A006	● F021B37A006	● F021B47A006	740,00 €	
● F021B17A012	● F021B27A012	● F021B37A012	● F021B47A012	740,00 €	
● F021B17A018	● F021B27A018	● F021B37A018	● F021B47A018	740,00 €	
● F021B17A030	● F021B27A030	● F021B37A030	● F021B47A030	740,00 €	
● F021B17A033	● F021B27A033	● F021B37A033	● F021B47A033	740,00 €	

3Continuous Line I/O H₂O Stop Fast Connect - Schéma électrique n.9 page 669 / Wiring diagram n.9 page 669

2200K	2700K	3000K	4000K		
○ F021C17A001	○ F021C27A001	○ F021C37A001	○ F021C47A001	781,00 €	
● F021C17A006	● F021C27A006	● F021C37A006	● F021C47A006	781,00 €	
● F021C17A012	● F021C27A012	● F021C37A012	● F021C47A012	781,00 €	
● F021C17A018	● F021C27A018	● F021C37A018	● F021C47A018	781,00 €	
● F021C17A030	● F021C27A030	● F021C37A030	● F021C47A030	781,00 €	
● F021C17A033	● F021C27A033	● F021C37A033	● F021C47A033	781,00 €	

*Standard Version: câble en sortie long. 1000 mm (accessoires de connexion à commander séparément) / 1000 mm length prewired cable (connecting accessory to be separately ordered).

2Quick Install In H₂O Stop Version: Connecteur H₂O Stop Plug&Play préinstallé pour connexion rapide (accessoires de connexion à commander séparément) / Prewired H₂O Stop Plug&Play connector for an easy/rapid connection (connecting accessory to be ordered separately).

3Continuous Line In/Out H₂O Stop Version: Connecteurs H₂O Stop Plug&Play préinstallés pour connexion en ligne (accessoires de connexion à commander séparément) / Prewired H₂O Stop Plug&Play connectors for an easy in line connection (connecting accessory to be ordered separately).

1Standard - Schéma électrique n.7 page 669 / Wiring diagram n.7 page 669

2200K		2700K		3000K		4000K		
○ F021A1CA001	○ F021A2CA001	○ F021A3CA001	○ F021A4CA001	○ F021A1CA006	○ F021A2CA006	○ F021A3CA006	○ F021A4CA006	697,00 €
● F021A1CA012	● F021A2CA012	● F021A3CA012	● F021A4CA012	● F021A1CA018	● F021A2CA018	● F021A3CA018	● F021A4CA018	697,00 €
● F021A1CA030	● F021A2CA030	● F021A3CA030	● F021A4CA030	● F021A1CA033	● F021A2CA033	● F021A3CA033	● F021A4CA033	697,00 €

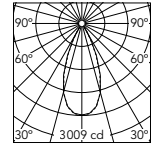

Beam Angle: 44°

h(m)	E(lx)	D(m)
1	3009	0.81
2	752	1.63
3	334	2.44
4	188	3.26
5	120	4.07

@4000K

2Quick Install I H₂O Stop Fast Connect - Schéma électrique n.8 page 669 / Wiring diagram n.8 page 669

2200K		2700K		3000K		4000K		
○ F021B1CA001	○ F021B2CA001	○ F021B3CA001	○ F021B4CA001	○ F021B1CA006	○ F021B2CA006	○ F021B3CA006	○ F021B4CA006	740,00 €
● F021B1CA012	● F021B2CA012	● F021B3CA012	● F021B4CA012	● F021B1CA018	● F021B2CA018	● F021B3CA018	● F021B4CA018	740,00 €
● F021B1CA030	● F021B2CA030	● F021B3CA030	● F021B4CA030	● F021B1CA033	● F021B2CA033	● F021B3CA033	● F021B4CA033	740,00 €

3Continuous Line I/O H₂O Stop Fast Connect - Schéma électrique n.9 page 669 / Wiring diagram n.9 page 669

2200K		2700K		3000K		4000K		
○ F021C1CA001	○ F021C2CA001	○ F021C3CA001	○ F021C4CA001	○ F021C1CA006	○ F021C2CA006	○ F021C3CA006	○ F021C4CA006	781,00 €
● F021C1CA012	● F021C2CA012	● F021C3CA012	● F021C4CA012	● F021C1CA018	● F021C2CA018	● F021C3CA018	● F021C4CA018	781,00 €
● F021C1CA030	● F021C2CA030	● F021C3CA030	● F021C4CA030	● F021C1CA033	● F021C2CA033	● F021C3CA033	● F021C4CA033	781,00 €

1Standard - Schéma électrique n.7 page 669 / Wiring diagram n.7 page 669

2200K		2700K		3000K		4000K		
○ F021A1GA001	○ F021A2GA001	○ F021A3GA001	○ F021A4GA001	○ F021A1GA006	○ F021A2GA006	○ F021A3GA006	○ F021A4GA006	697,00 €
● F021A1GA012	● F021A2GA012	● F021A3GA012	● F021A4GA012	● F021A1GA018	● F021A2GA018	● F021A3GA018	● F021A4GA018	697,00 €
● F021A1GA030	● F021A2GA030	● F021A3GA030	● F021A4GA030	● F021A1GA033	● F021A2GA033	● F021A3GA033	● F021A4GA033	697,00 €

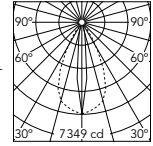

Beam Angle: 53°

h(m)	E(lx)	D(m)
1	7349	0.22
2	1837	0.44
3	817	0.66
4	459	0.88
5	294	1.10

@4000K

2Quick Install I H₂O Stop Fast Connect - Schéma électrique n.8 page 669 / Wiring diagram n.8 page 669

2200K		2700K		3000K		4000K		
○ F021B1GA001	○ F021B2GA001	○ F021B3GA001	○ F021B4GA001	○ F021B1GA006	○ F021B2GA006	○ F021B3GA006	○ F021B4GA006	740,00 €
● F021B1GA012	● F021B2GA012	● F021B3GA012	● F021B4GA012	● F021B1GA018	● F021B2GA018	● F021B3GA018	● F021B4GA018	740,00 €
● F021B1GA030	● F021B2GA030	● F021B3GA030	● F021B4GA030	● F021B1GA033	● F021B2GA033	● F021B3GA033	● F021B4GA033	740,00 €

3Continuous Line I/O H₂O Stop Fast Connect - Schéma électrique n.9 page 669 / Wiring diagram n.9 page 669

2200K		2700K		3000K		4000K		
○ F021C1GA001	○ F021C2GA001	○ F021C3GA001	○ F021C4GA001	○ F021C1GA006	○ F021C2GA006	○ F021C3GA006	○ F021C4GA006	781,00 €
● F021C1GA012	● F021C2GA012	● F021C3GA012	● F021C4GA012	● F021C1GA018	● F021C2GA018	● F021C3GA018	● F021C4GA018	781,00 €
● F021C1GA030	● F021C2GA030	● F021C3GA030	● F021C4GA030	● F021C1GA033	● F021C2GA033	● F021C3GA033	● F021C4GA033	781,00 €

1Standard - Schéma électrique n.7 page 669 / Wiring diagram n.7 page 669

2200K		2700K		3000K		4000K		
○ F021A1LA001	○ F021A2LA001	○ F021A3LA001	○ F021A4LA001	○ F021A1LA006	○ F021A2LA006	○ F021A3LA006	○ F021A4LA006	697,00 €
● F021A1LA012	● F021A2LA012	● F021A3LA012	● F021A4LA012	● F021A1LA018	● F021A2LA018	● F021A3LA018	● F021A4LA018	697,00 €
● F021A1LA030	● F021A2LA030	● F021A3LA030	● F021A4LA030	● F021A1LA033	● F021A2LA033	● F021A3LA033	● F021A4LA033	697,00 €

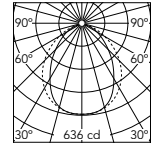

Beam Angle: 90°

h(m)	E(lx)	D(m)
1	636	1.74
2	159	3.49
3	71	5.23
4	40	6.98
5	25	8.72

@4000K

2Quick Install I H₂O Stop Fast Connect - Schéma électrique n.8 page 669 / Wiring diagram n.8 page 669

2200K		2700K		3000K		4000K		
○ F021B1LA001	○ F021B2LA001	○ F021B3LA001	○ F021B4LA001	○ F021B1LA006	○ F021B2LA006	○ F021B3LA006	○ F021B4LA006	740,00 €
● F021B1LA012	● F021B2LA012	● F021B3LA012	● F021B4LA012	● F021B1LA018	● F021B2LA018	● F021B3LA018	● F021B4LA018	740,00 €
● F021B1LA030	● F021B2LA030	● F021B3LA030	● F021B4LA030	● F021B1LA033	● F021B2LA033	● F021B3LA033	● F021B4LA033	740,00 €

3Continuous Line I/O H₂O Stop Fast Connect - Schéma électrique n.9 page 669 / Wiring diagram n.9 page 669

2200K		2700K		3000K		4000K		
○ F021C1LA001	○ F021C2LA001	○ F021C3LA001	○ F021C4LA001	○ F021C1LA006	○ F021C2LA006	○ F021C3LA006	○ F021C4LA006	781,00 €
● F021C1LA012	● F021C2LA012	● F021C3LA012	● F021C4LA012	● F021C1LA018	● F021C2LA018	● F021C3LA018	● F021C4LA018	781,00 €
● F021C1LA030	● F021C2LA030	● F021C3LA030	● F021C4LA030	● F021C1LA033	● F021C2LA033	● F021C3LA033	● F021C4LA033	781,00 €

Outgraze 50 L 1200 - Non Dimmable

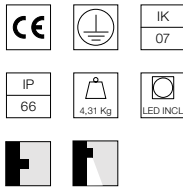
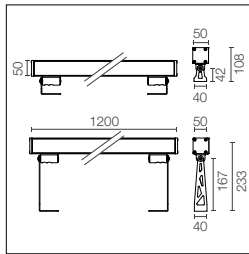

Alimentation 220/240V intégrée.
 Supports d'installation à commander séparément. Verre transparent extra clair, sauf en version DIFFUSE avec verre sablé.
 Version SMART sur demande (puissance 18,5W - flux - 30% lm).

Integrated 220/240V power supply. Installation brackets, to be ordered separately.
 Extra clear transparent glass, excluding the DIFFUSE version with sandblasted glass.
 SMART version available upon request (power 18,5W - flux -30% lm).

Power Led: 27W - 3338 lm ≠ *FIXT 2739 lm - 2700K/CRI 80 - 220-240V / 27W - 3458 lm ≠ *FIXT 2836 lm - 3000K/CRI 80 - 220-240V / 27W - 3577 lm ≠ *FIXT 2934 lm - 4000K/CRI 80 - 220-240V
 *FIXT lm = Medium Optic

1Standard - Schéma électrique n.7 page 669 / Wiring diagram n.7 page 669

2200K	2700K	3000K	4000K	
○ F021A14A001	○ F021A24A001	○ F021A34A001	○ F021A44A001	830,00 €
● F021A14A006	● F021A24A006	● F021A34A006	● F021A44A006	830,00 €
● F021A14A012	● F021A24A012	● F021A34A012	● F021A44A012	830,00 €
● F021A14A018	● F021A24A018	● F021A34A018	● F021A44A018	830,00 €
● F021A14A030	● F021A24A030	● F021A34A030	● F021A44A030	830,00 €
● F021A14A033	● F021A24A033	● F021A34A033	● F021A44A033	830,00 €

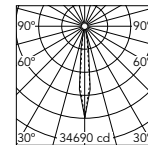

Beam Angle: 13°

h(m)	E(lx)	D(m)
1	34690	0.25
2	8672	0.49
3	3854	0.74
4	2168	0.98
5	1388	1.23

@4000K

2Quick Install I H₂O Stop Fast Connect - Schéma électrique n.8 page 669 / Wiring diagram n.8 page 669

2200K	2700K	3000K	4000K	
○ F021B14A001	○ F021B24A001	○ F021B34A001	○ F021B44A001	871,00 €
● F021B14A006	● F021B24A006	● F021B34A006	● F021B44A006	871,00 €
● F021B14A012	● F021B24A012	● F021B34A012	● F021B44A012	871,00 €
● F021B14A018	● F021B24A018	● F021B34A018	● F021B44A018	871,00 €
● F021B14A030	● F021B24A030	● F021B34A030	● F021B44A030	871,00 €
● F021B14A033	● F021B24A033	● F021B34A033	● F021B44A033	871,00 €

3Continuous Line I/O H₂O Stop Fast Connect - Schéma électrique n.9 page 669 / Wiring diagram n.9 page 669

2200K	2700K	3000K	4000K	
○ F021C14A001	○ F021C24A001	○ F021C34A001	○ F021C44A001	914,00 €
● F021C14A006	● F021C24A006	● F021C34A006	● F021C44A006	914,00 €
● F021C14A012	● F021C24A012	● F021C34A012	● F021C44A012	914,00 €
● F021C14A018	● F021C24A018	● F021C34A018	● F021C44A018	914,00 €
● F021C14A030	● F021C24A030	● F021C34A030	● F021C44A030	914,00 €
● F021C14A033	● F021C24A033	● F021C34A033	● F021C44A033	914,00 €

1Standard - Schéma électrique n.7 page 669 / Wiring diagram n.7 page 669

2200K	2700K	3000K	4000K	
○ F021A18A001	○ F021A28A001	○ F021A38A001	○ F021A48A001	830,00 €
● F021A18A006	● F021A28A006	● F021A38A006	● F021A48A006	830,00 €
● F021A18A012	● F021A28A012	● F021A38A012	● F021A48A012	830,00 €
● F021A18A018	● F021A28A018	● F021A38A018	● F021A48A018	830,00 €
● F021A18A030	● F021A28A030	● F021A38A030	● F021A48A030	830,00 €
● F021A18A033	● F021A28A033	● F021A38A033	● F021A48A033	830,00 €

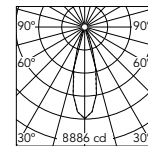

Beam Angle: 29°

h(m)	E(lx)	D(m)
1	8886	0.52
2	2222	1.04
3	987	1.56
4	555	2.08
5	355	2.60

@4000K

2Quick Install I H₂O Stop Fast Connect - Schéma électrique n.8 page 669 / Wiring diagram n.8 page 669

2200K	2700K	3000K	4000K	
○ F021B18A001	○ F021B28A001	○ F021B38A001	○ F021B48A001	871,00 €
● F021B18A006	● F021B28A006	● F021B38A006	● F021B48A006	871,00 €
● F021B18A012	● F021B28A012	● F021B38A012	● F021B48A012	871,00 €
● F021B18A018	● F021B28A018	● F021B38A018	● F021B48A018	871,00 €
● F021B18A030	● F021B28A030	● F021B38A030	● F021B48A030	871,00 €
● F021B18A033	● F021B28A033	● F021B38A033	● F021B48A033	871,00 €

3Continuous Line I/O H₂O Stop Fast Connect - Schéma électrique n.9 page 669 / Wiring diagram n.9 page 669

2200K	2700K	3000K	4000K	
○ F021C18A001	○ F021C28A001	○ F021C38A001	○ F021C48A001	914,00 €
● F021C18A006	● F021C28A006	● F021C38A006	● F021C48A006	914,00 €
● F021C18A012	● F021C28A012	● F021C38A012	● F021C48A012	914,00 €
● F021C18A018	● F021C28A018	● F021C38A018	● F021C48A018	914,00 €
● F021C18A030	● F021C28A030	● F021C38A030	● F021C48A030	914,00 €
● F021C18A033	● F021C28A033	● F021C38A033	● F021C48A033	914,00 €

¹Standard Version: câble en sortie long. 1000 mm (accessoires de connexion à commander séparément) / 1000 mm length prewired cable (connecting accessory to be separately ordered).

²Quick Install In H₂O Stop Version: Connecteur H₂O Stop Plug&Play préinstallé pour connexion rapide (accessoires de connexion à commander séparément) / Prewired H₂O Stop Plug&Play connector for an easy/rapid connection (connecting accessory to be ordered separately).

³Continuous Line In/Out H₂O Stop Version: Connecteurs H₂O Stop Plug&Play préinstallés pour connexion en ligne (accessoires de connexion à commander séparément) / Prewired H₂O Stop Plug&Play connectors for an easy in line connection (connecting accessory to be ordered separately).

1Standard - Schéma électrique n.7 page 669 / Wiring diagram n.7 page 669

2200K		2700K		3000K		4000K		
○ F021A1DA001	○ F021A2DA001	○ F021A3DA001	○ F021A4DA001	830,00 €				
● F021A1DA006	● F021A2DA006	● F021A3DA006	● F021A4DA006	830,00 €				
● F021A1DA012	● F021A2DA012	● F021A3DA012	● F021A4DA012	830,00 €				
● F021A1DA018	● F021A2DA018	● F021A3DA018	● F021A4DA018	830,00 €				
● F021A1DA030	● F021A2DA030	● F021A3DA030	● F021A4DA030	830,00 €				
● F021A1DA033	● F021A2DA033	● F021A3DA033	● F021A4DA033	830,00 €				

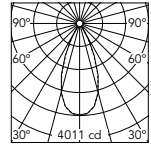

Beam Angle: 44°

h(m)	E(lx)	D(m)
1	4011	0.81
2	1003	1.63
3	446	2.44
4	251	3.26
5	160	4.07

@4000K

2Quick Install I H₂O Stop Fast Connect - Schéma électrique n.8 page 669 / Wiring diagram n.8 page 669

2200K		2700K		3000K		4000K		
○ F021B1DA001	○ F021B2DA001	○ F021B3DA001	○ F021B4DA001	871,00 €				
● F021B1DA006	● F021B2DA006	● F021B3DA006	● F021B4DA006	871,00 €				
● F021B1DA012	● F021B2DA012	● F021B3DA012	● F021B4DA012	871,00 €				
● F021B1DA018	● F021B2DA018	● F021B3DA018	● F021B4DA018	871,00 €				
● F021B1DA030	● F021B2DA030	● F021B3DA030	● F021B4DA030	871,00 €				
● F021B1DA033	● F021B2DA033	● F021B3DA033	● F021B4DA033	871,00 €				

3Continuous Line I/O H₂O Stop Fast Connect - Schéma électrique n.9 page 669 / Wiring diagram n.9 page 669

2200K		2700K		3000K		4000K		
○ F021C1DA001	○ F021C2DA001	○ F021C3DA001	○ F021C4DA001	914,00 €				
● F021C1DA006	● F021C2DA006	● F021C3DA006	● F021C4DA006	914,00 €				
● F021C1DA012	● F021C2DA012	● F021C3DA012	● F021C4DA012	914,00 €				
● F021C1DA018	● F021C2DA018	● F021C3DA018	● F021C4DA018	914,00 €				
● F021C1DA030	● F021C2DA030	● F021C3DA030	● F021C4DA030	914,00 €				
● F021C1DA033	● F021C2DA033	● F021C3DA033	● F021C4DA033	914,00 €				

1Standard - Schéma électrique n.7 page 669 / Wiring diagram n.7 page 669

2200K		2700K		3000K		4000K		
○ F021A1HA001	○ F021A2HA001	○ F021A3HA001	○ F021A4HA001	830,00 €				
● F021A1HA006	● F021A2HA006	● F021A3HA006	● F021A4HA006	830,00 €				
● F021A1HA012	● F021A2HA012	● F021A3HA012	● F021A4HA012	830,00 €				
● F021A1HA018	● F021A2HA018	● F021A3HA018	● F021A4HA018	830,00 €				
● F021A1HA030	● F021A2HA030	● F021A3HA030	● F021A4HA030	830,00 €				
● F021A1HA033	● F021A2HA033	● F021A3HA033	● F021A4HA033	830,00 €				

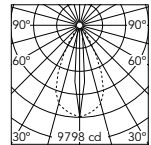

Beam Angle: 53°

h(m)	E(lx)	D(m)
1	9798	0.22
2	2450	0.44
3	1089	0.66
4	612	0.88
5	392	1.10

@4000K

2Quick Install I H₂O Stop Fast Connect - Schéma électrique n.8 page 669 / Wiring diagram n.8 page 669

2200K		2700K		3000K		4000K		
○ F021B1HA001	○ F021B2HA001	○ F021B3HA001	○ F021B4HA001	871,00 €				
● F021B1HA006	● F021B2HA006	● F021B3HA006	● F021B4HA006	871,00 €				
● F021B1HA012	● F021B2HA012	● F021B3HA012	● F021B4HA012	871,00 €				
● F021B1HA018	● F021B2HA018	● F021B3HA018	● F021B4HA018	871,00 €				
● F021B1HA030	● F021B2HA030	● F021B3HA030	● F021B4HA030	871,00 €				
● F021B1HA033	● F021B2HA033	● F021B3HA033	● F021B4HA033	871,00 €				

3Continuous Line I/O H₂O Stop Fast Connect - Schéma électrique n.9 page 669 / Wiring diagram n.9 page 669

2200K		2700K		3000K		4000K		
○ F021C1HA001	○ F021C2HA001	○ F021C3HA001	○ F021C4HA001	914,00 €				
● F021C1HA006	● F021C2HA006	● F021C3HA006	● F021C4HA006	914,00 €				
● F021C1HA012	● F021C2HA012	● F021C3HA012	● F021C4HA012	914,00 €				
● F021C1HA018	● F021C2HA018	● F021C3HA018	● F021C4HA018	914,00 €				
● F021C1HA030	● F021C2HA030	● F021C3HA030	● F021C4HA030	914,00 €				
● F021C1HA033	● F021C2HA033	● F021C3HA033	● F021C4HA033	914,00 €				

1Standard - Schéma électrique n.7 page 669 / Wiring diagram n.7 page 669

2200K		2700K		3000K		4000K		
○ F021A1MA001	○ F021A2MA001	○ F021A3MA001	○ F021A4MA001	830,00 €				
● F021A1MA006	● F021A2MA006	● F021A3MA006	● F021A4MA006	830,00 €				
● F021A1MA012	● F021A2MA012	● F021A3MA012	● F021A4MA012	830,00 €				
● F021A1MA018	● F021A2MA018	● F021A3MA018	● F021A4MA018	830,00 €				
● F021A1MA030	● F021A2MA030	● F021A3MA030	● F021A4MA030	830,00 €				
● F021A1MA033	● F021A2MA033	● F021A3MA033	● F021A4MA033	830,00 €				

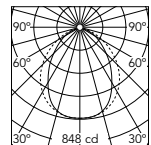

Beam Angle: 90°

h(m)	E(lx)	D(m)
1	848	1.74
2	212	3.49
3	94	5.23
4	53	6.98
5	34	8.72

@4000K

2Quick Install I H₂O Stop Fast Connect - Schéma électrique n.8 page 669 / Wiring diagram n.8 page 669

2200K		2700K		3000K		4000K		
○ F021B1MA001	○ F021B2MA001	○ F021B3MA001	○ F021B4MA001	871,00 €				
● F021B1MA006	● F021B2MA006	● F021B3MA006	● F021B4MA006	871,00 €				
● F021B1MA012	● F021B2MA012	● F021B3MA012	● F021B4MA012	871,00 €				
● F021B1MA018	● F021B2MA018	● F021B3MA018	● F021B4MA018	871,00 €				
● F021B1MA030	● F021B2MA030	● F021B3MA030	● F021B4MA030	871,00 €				
● F021B1MA033	● F021B2MA033	● F021B3MA033	● F021B4MA033	871,00 €				

3Continuous Line I/O H₂O Stop Fast Connect - Schéma électrique n.9 page 669 / Wiring diagram n.9 page 669

2200K		2700K		3000K		4000K		
○ F021C1MA001	○ F021C2MA001	○ F021C3MA001	○ F021C4MA001	914,00 €				
● F021C1MA006	● F021C2MA006	● F021C3MA006	● F021C4MA006	914,00 €				
● F021C1MA012	● F021C2MA012	● F021C3MA012	● F021C4MA012	914,00 €				
● F021C1MA018	● F021C2MA018	● F021C3MA018	● F021C4MA018	914,00 €				
● F021C1MA030	● F021C2MA030	● F021C3MA030	● F021C4MA030	914,00 €				
● F021C1MA033	● F021C2MA033	● F021C3MA033	● F021C4MA033	914,00 €				

Outgraze 50 L 600 - Dimmable DALI

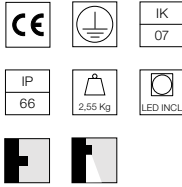
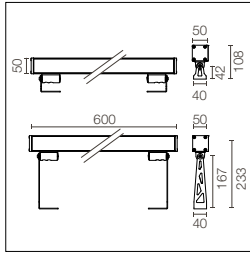

Alimentation 120/240V intégrée. Supports d'installation à commander séparément. Verre transparent extra clair, sauf en version DIFFUSE avec verre sablé. Version SMART dimmable DALI sur demande (puissance 7W - flux - 50% lm). Version dimmable 1-10V sur demande.

Integrated 120/240V power supply. Installation brackets, to be ordered separately. Extra clear transparent glass, excluding the DIFFUSE version with sandblasted glass. SMART dimmable DALI version available upon request (power 7W - flux - 50% lm). 1-10V dimmable version upon request.

Power Led: 14,5W - 1669 lm ≠ *FIXT 1369 lm - 2700K/CRI 80 - 120-240V / 14,5W - 1729 lm ≠ *FIXT 1418 lm - 3000K/CRI 80 - 120-240V / 14,5W - 1788 lm ≠ *FIXT 1467 lm - 4000K/CRI 80 -120-240V
 *FIXT lm = Medium Optic

²Quick Install I H₂O Stop Fast Connect - Schéma électrique n.10 page 670 / Wiring diagram n.10 page 670

2200K		2700K		3000K		4000K	
○ F021B12D001	○ F021B22D001	○ F021B32D001	○ F021B42D001	661,00 €			
● F021B12D006	● F021B22D006	● F021B32D006	● F021B42D006	661,00 €			
● F021B12D012	● F021B22D012	● F021B32D012	● F021B42D012	661,00 €			
● F021B12D018	● F021B22D018	● F021B32D018	● F021B42D018	661,00 €			
● F021B12D030	● F021B22D030	● F021B32D030	● F021B42D030	661,00 €			
● F021B12D033	● F021B22D033	● F021B32D033	● F021B42D033	661,00 €			

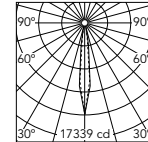

Beam Angle: 13°

h(m)	Et(κ)	D(m)
1	17339	0.25
2	4335	0.49
3	1927	0.74
4	1084	0.98
5	694	1.23

@4000K

³Continuous Line I/O H₂O Stop Fast Connect - Schéma électrique n.11 page 670 / Wiring diagram n.11 page 670

2200K		2700K		3000K		4000K	
○ F021C12D001	○ F021C22D001	○ F021C32D001	○ F021C42D001	697,00 €			
● F021C12D006	● F021C22D006	● F021C32D006	● F021C42D006	697,00 €			
● F021C12D012	● F021C22D012	● F021C32D012	● F021C42D012	697,00 €			
● F021C12D018	● F021C22D018	● F021C32D018	● F021C42D018	697,00 €			
● F021C12D030	● F021C22D030	● F021C32D030	● F021C42D030	697,00 €			
● F021C12D033	● F021C22D033	● F021C32D033	● F021C42D033	697,00 €			

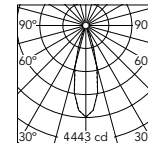

Beam Angle: 29°

h(m)	Et(κ)	D(m)
1	4443	0.52
2	1111	1.04
3	494	1.56
4	278	2.08
5	178	2.60

@4000K

²Quick Install I H₂O Stop Fast Connect - Schéma électrique n.10 page 670 / Wiring diagram n.10 page 670

2200K		2700K		3000K		4000K	
○ F021B16D001	○ F021B26D001	○ F021B36D001	○ F021B46D001	661,00 €			
● F021B16D006	● F021B26D006	● F021B36D006	● F021B46D006	661,00 €			
● F021B16D012	● F021B26D012	● F021B36D012	● F021B46D012	661,00 €			
● F021B16D018	● F021B26D018	● F021B36D018	● F021B46D018	661,00 €			
● F021B16D030	● F021B26D030	● F021B36D030	● F021B46D030	661,00 €			
● F021B16D033	● F021B26D033	● F021B36D033	● F021B46D033	661,00 €			

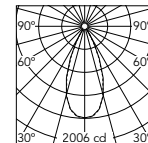

Beam Angle: 44°

h(m)	Et(κ)	D(m)
1	2006	0.81
2	501	1.63
3	223	2.44
4	125	3.26
5	80	4.07

@4000K

³Continuous Line I/O H₂O Stop Fast Connect - Schéma électrique n.11 page 670 / Wiring diagram n.11 page 670

2200K		2700K		3000K		4000K	
○ F021C16D001	○ F021C26D001	○ F021C36D001	○ F021C46D001	697,00 €			
● F021C16D006	● F021C26D006	● F021C36D006	● F021C46D006	697,00 €			
● F021C16D012	● F021C26D012	● F021C36D012	● F021C46D012	697,00 €			
● F021C16D018	● F021C26D018	● F021C36D018	● F021C46D018	697,00 €			
● F021C16D030	● F021C26D030	● F021C36D030	● F021C46D030	697,00 €			
● F021C16D033	● F021C26D033	● F021C36D033	● F021C46D033	697,00 €			

²Quick Install I H₂O Stop Fast Connect - Schéma électrique n.10 page 670 / Wiring diagram n.10 page 670

2200K		2700K		3000K		4000K	
○ F021B1BD001	○ F021B2BD001	○ F021B3BD001	○ F021B4BD001	661,00 €			
● F021B1BD006	● F021B2BD006	● F021B3BD006	● F021B4BD006	661,00 €			
● F021B1BD012	● F021B2BD012	● F021B3BD012	● F021B4BD012	661,00 €			
● F021B1BD018	● F021B2BD018	● F021B3BD018	● F021B4BD018	661,00 €			
● F021B1BD030	● F021B2BD030	● F021B3BD030	● F021B4BD030	661,00 €			
● F021B1BD033	● F021B2BD033	● F021B3BD033	● F021B4BD033	661,00 €			

³Continuous Line I/O H₂O Stop Fast Connect - Schéma électrique n.11 page 670 / Wiring diagram n.11 page 670

2200K		2700K		3000K		4000K	
○ F021C1BD001	○ F021C2BD001	○ F021C3BD001	○ F021C4BD001	697,00 €			
● F021C1BD006	● F021C2BD006	● F021C3BD006	● F021C4BD006	697,00 €			
● F021C1BD012	● F021C2BD012	● F021C3BD012	● F021C4BD012	697,00 €			
● F021C1BD018	● F021C2BD018	● F021C3BD018	● F021C4BD018	697,00 €			
● F021C1BD030	● F021C2BD030	● F021C3BD030	● F021C4BD030	697,00 €			
● F021C1BD033	● F021C2BD033	● F021C3BD033	● F021C4BD033	697,00 €			

²Quick Install In H₂O Stop Version: Connecteur H₂O Stop Plug&Play préinstallé pour connexion rapide (accessoires de connexion à commander séparément) / Prewired H₂O Stop Plug&Play connector for an easy/rapid connection (connecting accessory to be ordered separately).

³Continuous Line In/Out H₂O Stop Version: Connecteurs H₂O Stop Plug&Play préinstallés pour connexion en ligne (accessoires de connexion à commander séparément) / Prewired H₂O Stop Plug&Play connectors for an easy in line connection (connecting accessory to be ordered separately).

Quick Install I H₂O Stop Fast Connect - Schéma électrique n.10 page 670 / Wiring diagram n.10 page 670

2200K		2700K		3000K		4000K		
○ F021B1FD001	○ F021B2FD001	○ F021B3FD001	○ F021B4FD001	661,00 €				
● F021B1FD006	● F021B2FD006	● F021B3FD006	● F021B4FD006	661,00 €				
● F021B1FD012	● F021B2FD012	● F021B3FD012	● F021B4FD012	661,00 €				
● F021B1FD018	● F021B2FD018	● F021B3FD018	● F021B4FD018	661,00 €				
● F021B1FD030	● F021B2FD030	● F021B3FD030	● F021B4FD030	661,00 €				
● F021B1FD033	● F021B2FD033	● F021B3FD033	● F021B4FD033	661,00 €				

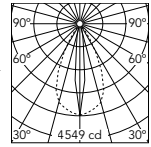

Beam Angle: 53°

h(m)	E(lx)	D(m)
1	4549	0.22
2	1137	0.44
3	505	0.66
4	284	0.88
5	182	1.10

@4000K

Continuous Line I/O H₂O Stop Fast Connect - Schéma électrique n.11 page 670 / Wiring diagram n.11 page 670

2200K		2700K		3000K		4000K		
○ F021C1FD001	○ F021C2FD001	○ F021C3FD001	○ F021C4FD001	697,00 €				
● F021C1FD006	● F021C2FD006	● F021C3FD006	● F021C4FD006	697,00 €				
● F021C1FD012	● F021C2FD012	● F021C3FD012	● F021C4FD012	697,00 €				
● F021C1FD018	● F021C2FD018	● F021C3FD018	● F021C4FD018	697,00 €				
● F021C1FD030	● F021C2FD030	● F021C3FD030	● F021C4FD030	697,00 €				
● F021C1FD033	● F021C2FD033	● F021C3FD033	● F021C4FD033	697,00 €				

Quick Install I H₂O Stop Fast Connect - Schéma électrique n.10 page 670 / Wiring diagram n.10 page 670

2200K		2700K		3000K		4000K		
○ F021B1KD001	○ F021B2KD001	○ F021B3KD001	○ F021B4KD001	661,00 €				
● F021B1KD006	● F021B2KD006	● F021B3KD006	● F021B4KD006	661,00 €				
● F021B1KD012	● F021B2KD012	● F021B3KD012	● F021B4KD012	661,00 €				
● F021B1KD018	● F021B2KD018	● F021B3KD018	● F021B4KD018	661,00 €				
● F021B1KD030	● F021B2KD030	● F021B3KD030	● F021B4KD030	661,00 €				
● F021B1KD033	● F021B2KD033	● F021B3KD033	● F021B4KD033	661,00 €				

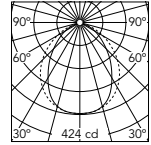

Beam Angle: 90°

h(m)	E(lx)	D(m)
1	424	1.74
2	106	3.49
3	47	5.23
4	26	6.98
5	17	8.72

@4000K

Continuous Line I/O H₂O Stop Fast Connect - Schéma électrique n.11 page 670 / Wiring diagram n.11 page 670

2200K		2700K		3000K		4000K		
○ F021C1KD001	○ F021C2KD001	○ F021C3KD001	○ F021C4KD001	697,00 €				
● F021C1KD006	● F021C2KD006	● F021C3KD006	● F021C4KD006	697,00 €				
● F021C1KD012	● F021C2KD012	● F021C3KD012	● F021C4KD012	697,00 €				
● F021C1KD018	● F021C2KD018	● F021C3KD018	● F021C4KD018	697,00 €				
● F021C1KD030	● F021C2KD030	● F021C3KD030	● F021C4KD030	697,00 €				
● F021C1KD033	● F021C2KD033	● F021C3KD033	● F021C4KD033	697,00 €				

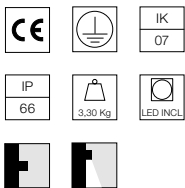
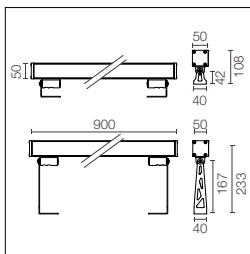

Alimentation 120/240V intégrée. Supports d'installation à commander séparément. Verre transparent extra clair, sauf en version DIFFUSE avec verre sablé. Version SMART dimmable DALI sur demande (puissance 11W - flux - 50% lm). Version dimmable 1-10V sur demande.

Integrated 120/240V power supply. Installation brackets, to be ordered separately. Extra clear transparent glass, excluding the DIFFUSE version with sandblasted glass. SMART dimmable DALI version available upon request (power 11W - flux -50% lm). 1-10V dimmable version upon request.

Power Led: 20W - 2504 lm ≠ *FIXT 2054 lm - 2700K/CRI 80 - 120-240V / 20W - 2593 lm ≠ *FIXT 2127 lm - 3000K/CRI 80 - 120-240V / 20W - 2683 lm ≠ *FIXT 2201 lm - 4000K/CRI 80 -120-240V / *FIXT lm = Medium Optic

2Quick Install I H₂O Stop Fast Connect - Schéma électrique n.10 page 670 / Wiring diagram n.10 page 670

2200K		2700K		3000K		4000K	
○ F021B13D001	○ F021B23D001	○ F021B33D001	○ F021B43D001	○ F021B33D001	○ F021B43D001	○ F021B33D001	○ F021B43D001
● F021B13D006	● F021B23D006	● F021B33D006	● F021B43D006	● F021B33D006	● F021B43D006	● F021B33D006	● F021B43D006
● F021B13D012	● F021B23D012	● F021B33D012	● F021B43D012	● F021B33D012	● F021B43D012	● F021B33D012	● F021B43D012
● F021B13D018	● F021B23D018	● F021B33D018	● F021B43D018	● F021B33D018	● F021B43D018	● F021B33D018	● F021B43D018
● F021B13D030	● F021B23D030	● F021B33D030	● F021B43D030	● F021B33D030	● F021B43D030	● F021B33D030	● F021B43D030
● F021B13D033	● F021B23D033	● F021B33D033	● F021B43D033	● F021B33D033	● F021B43D033	● F021B33D033	● F021B43D033

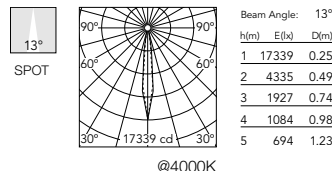

3Continuous Line I/O H₂O Stop Fast Connect - Schéma électrique n.11 page 670 / Wiring diagram n.11 page 670

2200K		2700K		3000K		4000K	
○ F021C13D001	○ F021C23D001	○ F021C33D001	○ F021C43D001	○ F021C33D001	○ F021C43D001	○ F021C33D001	○ F021C43D001
● F021C13D006	● F021C23D006	● F021C33D006	● F021C43D006	● F021C33D006	● F021C43D006	● F021C33D006	● F021C43D006
● F021C13D012	● F021C23D012	● F021C33D012	● F021C43D012	● F021C33D012	● F021C43D012	● F021C33D012	● F021C43D012
● F021C13D018	● F021C23D018	● F021C33D018	● F021C43D018	● F021C33D018	● F021C43D018	● F021C33D018	● F021C43D018
● F021C13D030	● F021C23D030	● F021C33D030	● F021C43D030	● F021C33D030	● F021C43D030	● F021C33D030	● F021C43D030
● F021C13D033	● F021C23D033	● F021C33D033	● F021C43D033	● F021C33D033	● F021C43D033	● F021C33D033	● F021C43D033

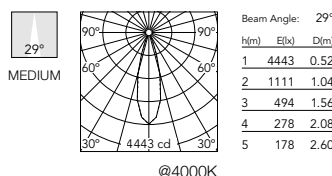

3Continuous Line I/O H₂O Stop Fast Connect - Schéma électrique n.11 page 670 / Wiring diagram n.11 page 670

2200K		2700K		3000K		4000K	
○ F021C17D001	○ F021C27D001	○ F021C37D001	○ F021C47D001	○ F021C37D001	○ F021C47D001	○ F021C37D001	○ F021C47D001
● F021C17D006	● F021C27D006	● F021C37D006	● F021C47D006	● F021C37D006	● F021C47D006	● F021C37D006	● F021C47D006
● F021C17D012	● F021C27D012	● F021C37D012	● F021C47D012	● F021C37D012	● F021C47D012	● F021C37D012	● F021C47D012
● F021C17D018	● F021C27D018	● F021C37D018	● F021C47D018	● F021C37D018	● F021C47D018	● F021C37D018	● F021C47D018
● F021C17D030	● F021C27D030	● F021C37D030	● F021C47D030	● F021C37D030	● F021C47D030	● F021C37D030	● F021C47D030
● F021C17D033	● F021C27D033	● F021C37D033	● F021C47D033	● F021C37D033	● F021C47D033	● F021C37D033	● F021C47D033

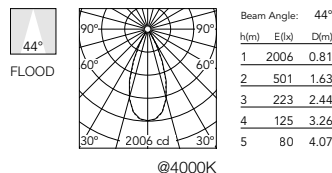

2Quick Install I H₂O Stop Fast Connect - Schéma électrique n.10 page 670 / Wiring diagram n.10 page 670

2200K		2700K		3000K		4000K	
○ F021B1CD001	○ F021B2CD001	○ F021B3CD001	○ F021B4CD001	○ F021B3CD001	○ F021B4CD001	○ F021B3CD001	○ F021B4CD001
● F021B1CD006	● F021B2CD006	● F021B3CD006	● F021B4CD006	● F021B3CD006	● F021B4CD006	● F021B3CD006	● F021B4CD006
● F021B1CD012	● F021B2CD012	● F021B3CD012	● F021B4CD012	● F021B3CD012	● F021B4CD012	● F021B3CD012	● F021B4CD012
● F021B1CD018	● F021B2CD018	● F021B3CD018	● F021B4CD018	● F021B3CD018	● F021B4CD018	● F021B3CD018	● F021B4CD018
● F021B1CD030	● F021B2CD030	● F021B3CD030	● F021B4CD030	● F021B3CD030	● F021B4CD030	● F021B3CD030	● F021B4CD030
● F021B1CD033	● F021B2CD033	● F021B3CD033	● F021B4CD033	● F021B3CD033	● F021B4CD033	● F021B3CD033	● F021B4CD033

3Continuous Line I/O H₂O Stop Fast Connect - Schéma électrique n.11 page 670 / Wiring diagram n.11 page 670

2200K		2700K		3000K		4000K	
○ F021C1CD001	○ F021C2CD001	○ F021C3CD001	○ F021C4CD001	○ F021C3CD001	○ F021C4CD001	○ F021C3CD001	○ F021C4CD001
● F021C1CD006	● F021C2CD006	● F021C3CD006	● F021C4CD006	● F021C3CD006	● F021C4CD006	● F021C3CD006	● F021C4CD006
● F021C1CD012	● F021C2CD012	● F021C3CD012	● F021C4CD012	● F021C3CD012	● F021C4CD012	● F021C3CD012	● F021C4CD012
● F021C1CD018	● F021C2CD018	● F021C3CD018	● F021C4CD018	● F021C3CD018	● F021C4CD018	● F021C3CD018	● F021C4CD018
● F021C1CD030	● F021C2CD030	● F021C3CD030	● F021C4CD030	● F021C3CD030	● F021C4CD030	● F021C3CD030	● F021C4CD030
● F021C1CD033	● F021C2CD033	● F021C3CD033	● F021C4CD033	● F021C3CD033	● F021C4CD033	● F021C3CD033	● F021C4CD033

*Quick Install In H₂O Stop Version: Connecteur H₂O Stop Plug&Play préinstallé pour connexion rapide (accessoires de connexion à commander séparément) / Prewired H₂O Stop Plug&Play connector for an easy/rapid connection (connecting accessory to be ordered separately).

*Continuous Line In/Out H₂O Stop Version: Connecteurs H₂O Stop Plug&Play préinstallés pour connexion en ligne (accessoires de connexion à commander séparément) / Prewired H₂O Stop Plug&Play connectors for an easy in line connection (connecting accessory to be ordered separately).

Quick Install I H₂O Stop Fast Connect - Schéma électrique n.10 page 670 / Wiring diagram n.10 page 670

2200K		2700K		3000K		4000K		
○ F021B1GD001	○ F021B2GD001	○ F021B3GD001	○ F021B4GD001	○ F021B3GD001	○ F021B4GD001	○ F021B3GD001	○ F021B4GD001	793,00 €
● F021B1GD006	● F021B2GD006	● F021B3GD006	● F021B4GD006	● F021B3GD006	● F021B4GD006	● F021B3GD006	● F021B4GD006	793,00 €
● F021B1GD012	● F021B2GD012	● F021B3GD012	● F021B4GD012	● F021B3GD012	● F021B4GD012	● F021B3GD012	● F021B4GD012	793,00 €
● F021B1GD018	● F021B2GD018	● F021B3GD018	● F021B4GD018	● F021B3GD018	● F021B4GD018	● F021B3GD018	● F021B4GD018	793,00 €
● F021B1GD030	● F021B2GD030	● F021B3GD030	● F021B4GD030	● F021B3GD030	● F021B4GD030	● F021B3GD030	● F021B4GD030	793,00 €
● F021B1GD033	● F021B2GD033	● F021B3GD033	● F021B4GD033	● F021B3GD033	● F021B4GD033	● F021B3GD033	● F021B4GD033	793,00 €

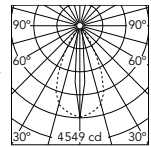

Beam Angle: 53°

h(m)	E(lx)	D(m)
1	4549	0.22
2	1137	0.44
3	505	0.66
4	284	0.88
5	182	1.10

@4000K

Continuous Line I/O H₂O Stop Fast Connect - Schéma électrique n.11 page 670 / Wiring diagram n.11 page 670

2200K		2700K		3000K		4000K		
○ F021C1GD001	○ F021C2GD001	○ F021C3GD001	○ F021C4GD001	○ F021C3GD001	○ F021C4GD001	○ F021C3GD001	○ F021C4GD001	830,00 €
● F021C1GD006	● F021C2GD006	● F021C3GD006	● F021C4GD006	● F021C3GD006	● F021C4GD006	● F021C3GD006	● F021C4GD006	830,00 €
● F021C1GD012	● F021C2GD012	● F021C3GD012	● F021C4GD012	● F021C3GD012	● F021C4GD012	● F021C3GD012	● F021C4GD012	830,00 €
● F021C1GD018	● F021C2GD018	● F021C3GD018	● F021C4GD018	● F021C3GD018	● F021C4GD018	● F021C3GD018	● F021C4GD018	830,00 €
● F021C1GD030	● F021C2GD030	● F021C3GD030	● F021C4GD030	● F021C3GD030	● F021C4GD030	● F021C3GD030	● F021C4GD030	830,00 €
● F021C1GD033	● F021C2GD033	● F021C3GD033	● F021C4GD033	● F021C3GD033	● F021C4GD033	● F021C3GD033	● F021C4GD033	830,00 €

Quick Install I H₂O Stop Fast Connect - Schéma électrique n.10 page 670 / Wiring diagram n.10 page 670

2200K		2700K		3000K		4000K		
○ F021B1LD001	○ F021B2LD001	○ F021B3LD001	○ F021B4LD001	○ F021B3LD001	○ F021B4LD001	○ F021B3LD001	○ F021B4LD001	793,00 €
● F021B1LD006	● F021B2LD006	● F021B3LD006	● F021B4LD006	● F021B3LD006	● F021B4LD006	● F021B3LD006	● F021B4LD006	793,00 €
● F021B1LD012	● F021B2LD012	● F021B3LD012	● F021B4LD012	● F021B3LD012	● F021B4LD012	● F021B3LD012	● F021B4LD012	793,00 €
● F021B1LD018	● F021B2LD018	● F021B3LD018	● F021B4LD018	● F021B3LD018	● F021B4LD018	● F021B3LD018	● F021B4LD018	793,00 €
● F021B1LD030	● F021B2LD030	● F021B3LD030	● F021B4LD030	● F021B3LD030	● F021B4LD030	● F021B3LD030	● F021B4LD030	793,00 €
● F021B1LD033	● F021B2LD033	● F021B3LD033	● F021B4LD033	● F021B3LD033	● F021B4LD033	● F021B3LD033	● F021B4LD033	793,00 €

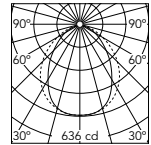

Beam Angle: 90°

h(m)	E(lx)	D(m)
1	636	1.74
2	159	3.49
3	71	5.23
4	40	6.98
5	25	8.72

@4000K

Continuous Line I/O H₂O Stop Fast Connect - Schéma électrique n.11 page 670 / Wiring diagram n.11 page 670

2200K		2700K		3000K		4000K		
○ F021C1LD001	○ F021C2LD001	○ F021C3LD001	○ F021C4LD001	○ F021C3LD001	○ F021C4LD001	○ F021C3LD001	○ F021C4LD001	830,00 €
● F021C1LD006	● F021C2LD006	● F021C3LD006	● F021C4LD006	● F021C3LD006	● F021C4LD006	● F021C3LD006	● F021C4LD006	830,00 €
● F021C1LD012	● F021C2LD012	● F021C3LD012	● F021C4LD012	● F021C3LD012	● F021C4LD012	● F021C3LD012	● F021C4LD012	830,00 €
● F021C1LD018	● F021C2LD018	● F021C3LD018	● F021C4LD018	● F021C3LD018	● F021C4LD018	● F021C3LD018	● F021C4LD018	830,00 €
● F021C1LD030	● F021C2LD030	● F021C3LD030	● F021C4LD030	● F021C3LD030	● F021C4LD030	● F021C3LD030	● F021C4LD030	830,00 €
● F021C1LD033	● F021C2LD033	● F021C3LD033	● F021C4LD033	● F021C3LD033	● F021C4LD033	● F021C3LD033	● F021C4LD033	830,00 €

Outgraze 50 L 1200 - Dimmable DALI

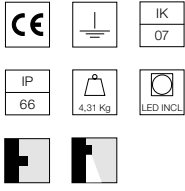
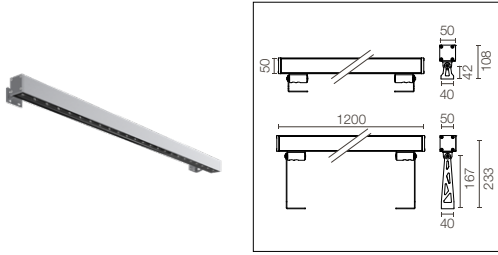

Alimentation 120/240V intégrée. Supports d'installation à commander séparément. Verre transparent extra clair, sauf en version DIFFUSE avec verre sablé. Version SMART dimmable DALI sur demande (puissance 14W - flux - 50% lm). Version dimmable 1-10V sur demande.

Integrated 120/240V power supply. Installation brackets, to be ordered separately. Extra clear transparent glass, excluding the DIFFUSE version with sandblasted glass. SMART dimmable DALI version available upon request (power 14W - flux -50% lm). 1-10V dimmable version upon request.

Power Led: 27W - 3338 lm ≠ *FIXT 2739 lm - 2700K/CRI 80 - 120-240V / 27W - 3458 lm ≠ *FIXT 2836 lm - 3000K/CRI 80 - 120-240V / 27W - 3577 lm ≠ *FIXT 2934 lm - 4000K/CRI 80 -120-240V
 *FIXT lm = Medium Optic

²Quick Install I H₂O Stop Fast Connect - Schéma électrique n.10 page 670 / Wiring diagram n.10 page 670

2200K		2700K		3000K		4000K	
○ F021B14D001	○ F021B24D001	○ F021B34D001	○ F021B44D001	937,00 €			
● F021B14D006	● F021B24D006	● F021B34D006	● F021B44D006	937,00 €			
● F021B14D012	● F021B24D012	● F021B34D012	● F021B44D012	937,00 €			
● F021B14D018	● F021B24D018	● F021B34D018	● F021B44D018	937,00 €			
● F021B14D030	● F021B24D030	● F021B34D030	● F021B44D030	937,00 €			
● F021B14D033	● F021B24D033	● F021B34D033	● F021B44D033	937,00 €			

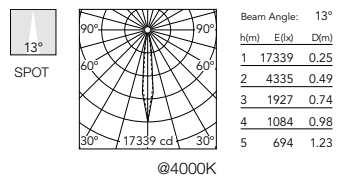

³Continuous Line I/O H₂O Stop Fast Connect - Schéma électrique n.11 page 670 / Wiring diagram n.11 page 670

2200K		2700K		3000K		4000K	
○ F021C14D001	○ F021C24D001	○ F021C34D001	○ F021C44D001	974,00 €			
● F021C14D006	● F021C24D006	● F021C34D006	● F021C44D006	974,00 €			
● F021C14D012	● F021C24D012	● F021C34D012	● F021C44D012	974,00 €			
● F021C14D018	● F021C24D018	● F021C34D018	● F021C44D018	974,00 €			
● F021C14D030	● F021C24D030	● F021C34D030	● F021C44D030	974,00 €			
● F021C14D033	● F021C24D033	● F021C34D033	● F021C44D033	974,00 €			

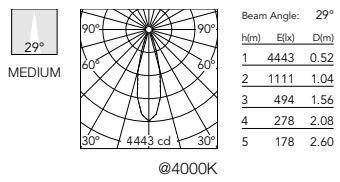

²Quick Install I H₂O Stop Fast Connect - Schéma électrique n.10 page 670 / Wiring diagram n.10 page 670

2200K		2700K		3000K		4000K	
○ F021B18D001	○ F021B28D001	○ F021B38D001	○ F021B48D001	937,00 €			
● F021B18D006	● F021B28D006	● F021B38D006	● F021B48D006	937,00 €			
● F021B18D012	● F021B28D012	● F021B38D012	● F021B48D012	937,00 €			
● F021B18D018	● F021B28D018	● F021B38D018	● F021B48D018	937,00 €			
● F021B18D030	● F021B28D030	● F021B38D030	● F021B48D030	937,00 €			
● F021B18D033	● F021B28D033	● F021B38D033	● F021B48D033	937,00 €			

³Continuous Line I/O H₂O Stop Fast Connect - Schéma électrique n.11 page 670 / Wiring diagram n.11 page 670

2200K		2700K		3000K		4000K	
○ F021C18D001	○ F021C28D001	○ F021C38D001	○ F021C48D001	974,00 €			
● F021C18D006	● F021C28D006	● F021C38D006	● F021C48D006	974,00 €			
● F021C18D012	● F021C28D012	● F021C38D012	● F021C48D012	974,00 €			
● F021C18D018	● F021C28D018	● F021C38D018	● F021C48D018	974,00 €			
● F021C18D030	● F021C28D030	● F021C38D030	● F021C48D030	974,00 €			
● F021C18D033	● F021C28D033	● F021C38D033	● F021C48D033	974,00 €			

²Quick Install I H₂O Stop Fast Connect - Schéma électrique n.10 page 670 / Wiring diagram n.10 page 670

2200K		2700K		3000K		4000K	
○ F021B1DD001	○ F021B2DD001	○ F021B3DD001	○ F021B4DD001	937,00 €			
● F021B1DD006	● F021B2DD006	● F021B3DD006	● F021B4DD006	937,00 €			
● F021B1DD012	● F021B2DD012	● F021B3DD012	● F021B4DD012	937,00 €			
● F021B1DD018	● F021B2DD018	● F021B3DD018	● F021B4DD018	937,00 €			
● F021B1DD030	● F021B2DD030	● F021B3DD030	● F021B4DD030	937,00 €			
● F021B1DD033	● F021B2DD033	● F021B3DD033	● F021B4DD033	937,00 €			

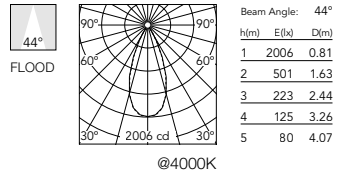

³Continuous Line I/O H₂O Stop Fast Connect - Schéma électrique n.11 page 670 / Wiring diagram n.11 page 670

2200K		2700K		3000K		4000K	
○ F021C1DD001	○ F021C2DD001	○ F021C3DD001	○ F021C4DD001	974,00 €			
● F021C1DD006	● F021C2DD006	● F021C3DD006	● F021C4DD006	974,00 €			
● F021C1DD012	● F021C2DD012	● F021C3DD012	● F021C4DD012	974,00 €			
● F021C1DD018	● F021C2DD018	● F021C3DD018	● F021C4DD018	974,00 €			
● F021C1DD030	● F021C2DD030	● F021C3DD030	● F021C4DD030	974,00 €			
● F021C1DD033	● F021C2DD033	● F021C3DD033	● F021C4DD033	974,00 €			

²Quick Install In H₂O Stop Version: Connecteur H₂O Stop Plug&Play préinstallé pour connexion rapide (accessoires de connexion à commander séparément) / Prewired H₂O Stop Plug&Play connector for an easy/rapid connection (connecting accessory to be ordered separately).

³Continuous Line In/Out H₂O Stop Version: Connecteurs H₂O Stop Plug&Play préinstallés pour connexion en ligne (accessoires de connexion à commander séparément) / Prewired H₂O Stop Plug&Play connectors for an easy in line connection (connecting accessory to be ordered separately).

Quick Install I H₂O Stop Fast Connect - Schéma électrique n.10 page 670 / Wiring diagram n.10 page 670

2200K		2700K		3000K		4000K		
○ F021B1HD001	○ F021B2HD001	○ F021B3HD001	○ F021B4HD001	○ F021B3HD001	○ F021B4HD001	○ F021B3HD001	○ F021B4HD001	937,00 €
● F021B1HD006	● F021B2HD006	● F021B3HD006	● F021B4HD006	● F021B3HD006	● F021B4HD006	● F021B3HD006	● F021B4HD006	937,00 €
● F021B1HD012	● F021B2HD012	● F021B3HD012	● F021B4HD012	● F021B3HD012	● F021B4HD012	● F021B3HD012	● F021B4HD012	937,00 €
● F021B1HD018	● F021B2HD018	● F021B3HD018	● F021B4HD018	● F021B3HD018	● F021B4HD018	● F021B3HD018	● F021B4HD018	937,00 €
● F021B1HD030	● F021B2HD030	● F021B3HD030	● F021B4HD030	● F021B3HD030	● F021B4HD030	● F021B3HD030	● F021B4HD030	937,00 €
● F021B1HD033	● F021B2HD033	● F021B3HD033	● F021B4HD033	● F021B3HD033	● F021B4HD033	● F021B3HD033	● F021B4HD033	937,00 €

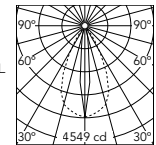

Beam Angle: 53°

h(m)	E(lx)	D(m)
1	4549	0.22
2	1137	0.44
3	505	0.66
4	284	0.88
5	182	1.10

@4000K

Continuous Line I/O H₂O Stop Fast Connect - Schéma électrique n.11 page 670 / Wiring diagram n.11 page 670

2200K		2700K		3000K		4000K		
○ F021C1HD001	○ F021C2HD001	○ F021C3HD001	○ F021C4HD001	○ F021C3HD001	○ F021C4HD001	○ F021C3HD001	○ F021C4HD001	974,00 €
● F021C1HD006	● F021C2HD006	● F021C3HD006	● F021C4HD006	● F021C3HD006	● F021C4HD006	● F021C3HD006	● F021C4HD006	974,00 €
● F021C1HD012	● F021C2HD012	● F021C3HD012	● F021C4HD012	● F021C3HD012	● F021C4HD012	● F021C3HD012	● F021C4HD012	974,00 €
● F021C1HD018	● F021C2HD018	● F021C3HD018	● F021C4HD018	● F021C3HD018	● F021C4HD018	● F021C3HD018	● F021C4HD018	974,00 €
● F021C1HD030	● F021C2HD030	● F021C3HD030	● F021C4HD030	● F021C3HD030	● F021C4HD030	● F021C3HD030	● F021C4HD030	974,00 €
● F021C1HD033	● F021C2HD033	● F021C3HD033	● F021C4HD033	● F021C3HD033	● F021C4HD033	● F021C3HD033	● F021C4HD033	974,00 €

Quick Install I H₂O Stop Fast Connect - Schéma électrique n.10 page 670 / Wiring diagram n.10 page 670

2200K		2700K		3000K		4000K		
○ F021B1MD001	○ F021B2MD001	○ F021B3MD001	○ F021B4MD001	○ F021B3MD001	○ F021B4MD001	○ F021B3MD001	○ F021B4MD001	937,00 €
● F021B1MD006	● F021B2MD006	● F021B3MD006	● F021B4MD006	● F021B3MD006	● F021B4MD006	● F021B3MD006	● F021B4MD006	937,00 €
● F021B1MD012	● F021B2MD012	● F021B3MD012	● F021B4MD012	● F021B3MD012	● F021B4MD012	● F021B3MD012	● F021B4MD012	937,00 €
● F021B1MD018	● F021B2MD018	● F021B3MD018	● F021B4MD018	● F021B3MD018	● F021B4MD018	● F021B3MD018	● F021B4MD018	937,00 €
● F021B1MD030	● F021B2MD030	● F021B3MD030	● F021B4MD030	● F021B3MD030	● F021B4MD030	● F021B3MD030	● F021B4MD030	937,00 €
● F021B1MD033	● F021B2MD033	● F021B3MD033	● F021B4MD033	● F021B3MD033	● F021B4MD033	● F021B3MD033	● F021B4MD033	937,00 €

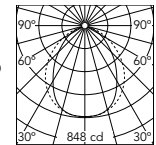

Beam Angle: 90°

h(m)	E(lx)	D(m)
1	848	1.74
2	212	3.49
3	94	5.23
4	53	6.98
5	34	8.72

@4000K

Continuous Line I/O H₂O Stop Fast Connect - Schéma électrique n.11 page 670 / Wiring diagram n.11 page 670

2200K		2700K		3000K		4000K		
○ F021C1MD001	○ F021C2MD001	○ F021C3MD001	○ F021C4MD001	○ F021C3MD001	○ F021C4MD001	○ F021C3MD001	○ F021C4MD001	974,00 €
● F021C1MD006	● F021C2MD006	● F021C3MD006	● F021C4MD006	● F021C3MD006	● F021C4MD006	● F021C3MD006	● F021C4MD006	974,00 €
● F021C1MD012	● F021C2MD012	● F021C3MD012	● F021C4MD012	● F021C3MD012	● F021C4MD012	● F021C3MD012	● F021C4MD012	974,00 €
● F021C1MD018	● F021C2MD018	● F021C3MD018	● F021C4MD018	● F021C3MD018	● F021C4MD018	● F021C3MD018	● F021C4MD018	974,00 €
● F021C1MD030	● F021C2MD030	● F021C3MD030	● F021C4MD030	● F021C3MD030	● F021C4MD030	● F021C3MD030	● F021C4MD030	974,00 €
● F021C1MD033	● F021C2MD033	● F021C3MD033	● F021C4MD033	● F021C3MD033	● F021C4MD033	● F021C3MD033	● F021C4MD033	974,00 €

Outgraze 50 - RGB

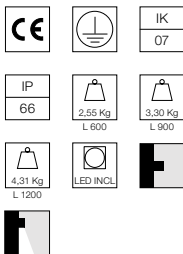
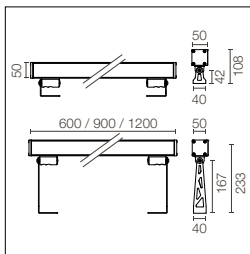

Alimentation électrique 120/240V et interface DMX-RDM intégrée. Supports d'installation à commander séparément. Verre sablé.

Intergrated 120/240V power supply and DMX-RDM interface. Installation brackets, to be ordered separately. Sandblasted glass.

Power Led: L600: 26W - 120-240V - DMX-RDM interface / L900: 37W - 120-240V - DMX-RDM interface / L1200: 48W - 120-240V - DMX-RDM interface

Schéma électrique n.12 page 670 / Wiring diagram n.12 page 670

L 600		L 900		L 1200	
○ F021MRKJ001	1.260,00 €	○ F021MRLJ001	1.499,00 €	○ F021MRMJ001	1.799,00 €
● F021MRKJ006	1.260,00 €	● F021MRLJ006	1.499,00 €	● F021MRMJ006	1.799,00 €
● F021MRKJ012	1.260,00 €	● F021MRLJ012	1.499,00 €	● F021MRMJ012	1.799,00 €
● F021MRKJ018	1.260,00 €	● F021MRLJ018	1.499,00 €	● F021MRMJ018	1.799,00 €
● F021MRKJ030	1.260,00 €	● F021MRLJ030	1.499,00 €	● F021MRMJ030	1.799,00 €
● F021MRKJ033	1.260,00 €	● F021MRLJ033	1.499,00 €	● F021MRMJ033	1.799,00 €



Photometric data on request.

Outgraze 50 - RGBW

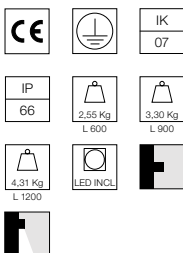
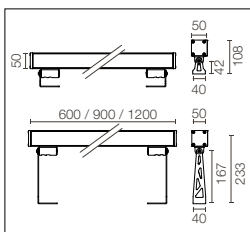

Alimentation électrique 120/240V et interface DMX-RDM intégrée. Supports d'installation à commander séparément. Verre sablé.

Intergrated 120/240V power supply and DMX-RDM interface. Installation brackets, to be ordered separately. Sandblasted glass.

Power Led: L600: 24W - 120-240V - DMX-RDM interface / L900: 33W - 120-240V - DMX-RDM interface / L1200: 43W 120-240V - DMX-RDM interface

Schéma électrique n.12 page 670 / Wiring diagram n.12 page 670

L 600		L 900		L 1200	
○ F021MWKJ001	1.320,00 €	○ F021MWLJ001	1.561,00 €	○ F021MWMJ001	1.860,00 €
● F021MWKJ006	1.320,00 €	● F021MWLJ006	1.561,00 €	● F021MWMJ006	1.860,00 €
● F021MWKJ012	1.320,00 €	● F021MWLJ012	1.561,00 €	● F021MWMJ012	1.860,00 €
● F021MWKJ018	1.320,00 €	● F021MWLJ018	1.561,00 €	● F021MWMJ018	1.860,00 €
● F021MWKJ030	1.320,00 €	● F021MWLJ030	1.561,00 €	● F021MWMJ030	1.860,00 €
● F021MWKJ033	1.320,00 €	● F021MWLJ033	1.561,00 €	● F021MWMJ033	1.860,00 €



Photometric data on request.

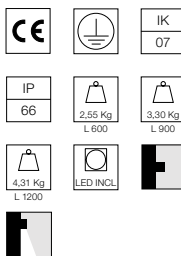
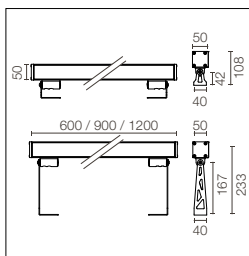

Alimentation 120/240V DALI intégrée. Supports d'installation à commander séparément. Verre sablé.

120/240V DALI integrated power supply. Installation brackets, to be ordered separately. Sandblasted glass.

Power Led: L600: 13W - 1413 lm ≠ FIXT 722 lm - 2700K/CRI 80 - 120-240V / L900: 18,5W - 1669 lm ≠ FIXT 1082 lm - 2700K/CRI 80 - 120-240V / L1200: 23W - 2826 lm ≠ FIXT 1443 lm - 2700K/CRI 80 - 120-240V

Quick Install I H₂O Stop Fast Connect - Schéma électrique n.10 page 670 / Wiring diagram n.10 page 670

L 600

- F021PTKD001 1.022,00 €
- F021PTKD006 1.022,00 €
- F021PTKD012 1.022,00 €
- F021PTKD018 1.022,00 €
- F021PTKD030 1.022,00 €
- F021PTKD033 1.022,00 €

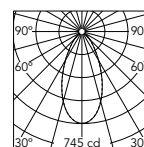

Beam Angle: 50°	
h(m)	E(lx) D(m)
1	745 0.94
2	186 1.88
3	83 2.82
4	47 3.77
5	30 4.71

@4000K

Continuous Line I/O H₂O Stop Fast Connect - Schéma électrique n.11 page 670 / Wiring diagram n.11 page 670

L 600

- F021QTKD001 1.057,00 €
- F021QTKD006 1.057,00 €
- F021QTKD012 1.057,00 €
- F021QTKD018 1.057,00 €
- F021QTKD030 1.057,00 €
- F021QTKD033 1.057,00 €

Quick Install I H₂O Stop Fast Connect - Schéma électrique n.10 page 670 / Wiring diagram n.10 page 670

L 900

- F021PTLD001 1.260,00 €
- F021PTLD006 1.260,00 €
- F021PTLD012 1.260,00 €
- F021PTLD018 1.260,00 €
- F021PTLD030 1.260,00 €
- F021PTLD033 1.260,00 €

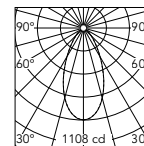

Beam Angle: 50°	
h(m)	E(lx) D(m)
1	1108 0.94
2	277 1.88
3	123 2.82
4	69 3.77
5	44 4.71

@4000K

Continuous Line I/O H₂O Stop Fast Connect - Schéma électrique n.11 page 670 / Wiring diagram n.11 page 670

L 900

- F021QTLD001 1.297,00 €
- F021QTLD006 1.297,00 €
- F021QTLD012 1.297,00 €
- F021QTLD018 1.297,00 €
- F021QTLD030 1.297,00 €
- F021QTLD033 1.297,00 €

Quick Install I H₂O Stop Fast Connect - Schéma électrique n.10 page 670 / Wiring diagram n.10 page 670

L 1200

- F021PTMD001 1.499,00 €
- F021PTMD006 1.499,00 €
- F021PTMD012 1.499,00 €
- F021PTMD018 1.499,00 €
- F021PTMD030 1.499,00 €
- F021PTMD033 1.499,00 €

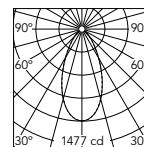

Beam Angle: 50°	
h(m)	E(lx) D(m)
1	1477 0.94
2	369 1.88
3	164 2.82
4	92 3.77
5	59 4.71

@4000K

Continuous Line I/O H₂O Stop Fast Connect - Schéma électrique n.11 page 670 / Wiring diagram n.11 page 670

L 1200

- F021QTMD001 1.537,00 €
- F021QTMD006 1.537,00 €
- F021QTMD012 1.537,00 €
- F021QTMD018 1.537,00 €
- F021QTMD030 1.537,00 €
- F021QTMD033 1.537,00 €

²Quick Install In H₂O Stop Version: Connecteur H₂O Stop Plug&Play préinstallé pour connexion rapide (accessoires de connexion à commander séparément) / Prewired H₂O Stop Plug&Play connector for an easy/rapid connection (connecting accessory to be ordered separately).

³Continuous Line In/Out H₂O Stop Version: Connecteurs H₂O Stop Plug&Play préinstallés pour connexion en ligne (accessoires de connexion à commander séparément) / Prewired H₂O Stop Plug&Play connectors for an easy in line connection (connecting accessory to be ordered separately).

Outgraze 50 Easy L 300 - Non Dimmable

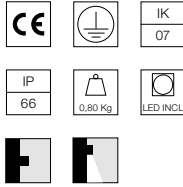
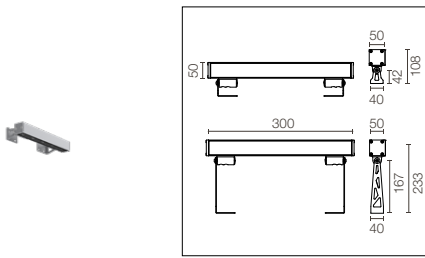

Alimentation 220/240V intégrée.
Supports d'installation à commander séparément.
Verre sablé.

Integrated 220/240V power supply. Installation brackets, to be ordered separately.
Sandblasted glass.

Mid-power Led: 8W - 806 lm ≠ FIXT 310 lm - 2700K/CRI 80 - 220-240V / 8W - 876 lm ≠ FIXT 337 lm - 3000K/CRI 80 - 220-240V / 8W - 946 lm ≠ FIXT 364 lm - 4000K/CRI 80 - 220-240V

¹Standard - Schéma électrique n.7 page 669 / Wiring diagram n.7 page 669

2700K		3000K		4000K	
○ F021G2JA001	361,00 €	○ F021G3JA001	361,00 €	○ F021G4JA001	361,00 €
● F021G2JA006	361,00 €	● F021G3JA006	361,00 €	● F021G4JA006	361,00 €
● F021G2JA012	361,00 €	● F021G3JA012	361,00 €	● F021G4JA012	361,00 €
● F021G2JA018	361,00 €	● F021G3JA018	361,00 €	● F021G4JA018	361,00 €
● F021G2JA030	361,00 €	● F021G3JA030	361,00 €	● F021G4JA030	361,00 €
● F021G2JA033	361,00 €	● F021G3JA033	361,00 €	● F021G4JA033	361,00 €

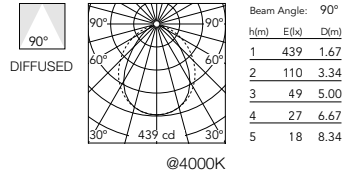

²Quick Install I H₂O Stop Fast Connect - Schéma électrique n.8 page 669 / Wiring diagram n.8 page 669

2700K		3000K		4000K	
○ F021H2JA001	403,00 €	○ F021H3JA001	403,00 €	○ F021H4JA001	403,00 €
● F021H2JA006	403,00 €	● F021H3JA006	403,00 €	● F021H4JA006	403,00 €
● F021H2JA012	403,00 €	● F021H3JA012	403,00 €	● F021H4JA012	403,00 €
● F021H2JA018	403,00 €	● F021H3JA018	403,00 €	● F021H4JA018	403,00 €
● F021H2JA030	403,00 €	● F021H3JA030	403,00 €	● F021H4JA030	403,00 €
● F021H2JA033	403,00 €	● F021H3JA033	403,00 €	● F021H4JA033	403,00 €

Outgraze 50 Easy L 600 - Non Dimmable

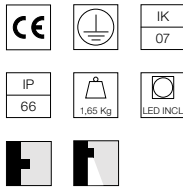
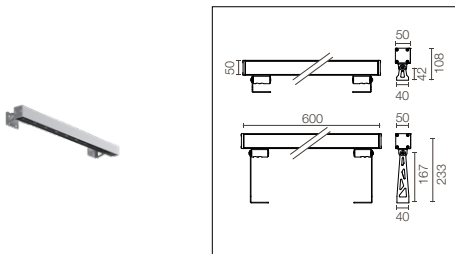

Alimentation 220/240V intégrée.
Supports d'installation à commander séparément.
Verre sablé.

Integrated 220/240V power supply. Installation brackets, to be ordered separately.
Sandblasted glass.

Mid-power Led: 14,5W - 1612 lm ≠ FIXT 620 lm - 2700K/CRI 80 - 220-240V / 14,5W - 1752 lm ≠ FIXT 674 lm - 3000K/CRI 80 - 220-240V / 14,5W - 1892 lm ≠ FIXT 728 lm - 4000K/CRI 80 - 220-240V

¹Standard - Schéma électrique n.7 page 669 / Wiring diagram n.7 page 669

2700K		3000K		4000K	
○ F021G2KA001	458,00 €	○ F021G3KA001	458,00 €	○ F021G4KA001	458,00 €
● F021G2KA006	458,00 €	● F021G3KA006	458,00 €	● F021G4KA006	458,00 €
● F021G2KA012	458,00 €	● F021G3KA012	458,00 €	● F021G4KA012	458,00 €
● F021G2KA018	458,00 €	● F021G3KA018	458,00 €	● F021G4KA018	458,00 €
● F021G2KA030	458,00 €	● F021G3KA030	458,00 €	● F021G4KA030	458,00 €
● F021G2KA033	458,00 €	● F021G3KA033	458,00 €	● F021G4KA033	458,00 €

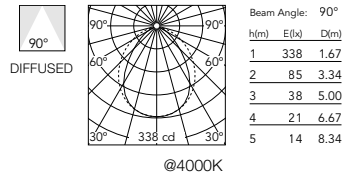

²Quick Install I H₂O Stop Fast Connect - Schéma électrique n.8 page 669 / Wiring diagram n.8 page 669

2700K		3000K		4000K	
○ F021H2KA001	499,00 €	○ F021H3KA001	499,00 €	○ F021H4KA001	499,00 €
● F021H2KA006	499,00 €	● F021H3KA006	499,00 €	● F021H4KA006	499,00 €
● F021H2KA012	499,00 €	● F021H3KA012	499,00 €	● F021H4KA012	499,00 €
● F021H2KA018	499,00 €	● F021H3KA018	499,00 €	● F021H4KA018	499,00 €
● F021H2KA030	499,00 €	● F021H3KA030	499,00 €	● F021H4KA030	499,00 €
● F021H2KA033	499,00 €	● F021H3KA033	499,00 €	● F021H4KA033	499,00 €

³Continuous Line I/O H₂O Stop Fast Connect - Schéma électrique n.9 page 669 / Wiring diagram n.9 page 669

2700K		3000K		4000K	
○ F021J2KA001	542,00 €	○ F021J3KA001	542,00 €	○ F021J4KA001	542,00 €
● F021J2KA006	542,00 €	● F021J3KA006	542,00 €	● F021J4KA006	542,00 €
● F021J2KA012	542,00 €	● F021J3KA012	542,00 €	● F021J4KA012	542,00 €
● F021J2KA018	542,00 €	● F021J3KA018	542,00 €	● F021J4KA018	542,00 €
● F021J2KA030	542,00 €	● F021J3KA030	542,00 €	● F021J4KA030	542,00 €
● F021J2KA033	542,00 €	● F021J3KA033	542,00 €	● F021J4KA033	542,00 €

¹Standard Version: câble en sortie long. 1000 mm (accessoires de connexion à commander séparément) / 1000 mm length prewired cable (connecting accessory to be separately ordered).

²Quick Install In H₂O Stop Version: Connecteur H₂O Stop Plug&Play préinstallé pour connexion rapide (accessoires de connexion à commander séparément) / Prewired H₂O Stop Plug&Play connector for an easy/rapid connection (connecting accessory to be ordered separately).

³Continuous Line In/Out H₂O Stop Version: Connecteurs H₂O Stop Plug&Play préinstallés pour connexion en ligne (accessoires de connexion à commander séparément) / Prewired H₂O Stop Plug&Play connectors for an easy in line connection (connecting accessory to be ordered separately).

Outgraze 50 Easy L 900 - Non Dimmable

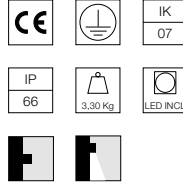
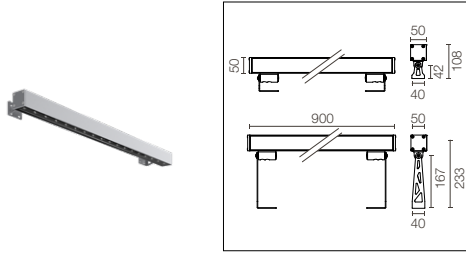

Alimentation 220/240V intégrée.
Supports d'installation à commander séparément.
Verre sablé.

Integrated 220/240V power supply. Installation brackets, to be ordered separately.
Sandblasted glass.

Mid-power Led: 20W - 2418 lm ≠ FIXT 930 lm - 2700K/CRI 80 - 220-240V / 20W - 2628 lm ≠ FIXT 1011 lm - 3000K/CRI 80 - 220-240V / 20W - 2839 lm ≠ FIXT 1092 lm - 4000K/CRI 80 - 220-240V

¹Standard - Schéma électrique n.7 page 669 / Wiring diagram n.7 page 669

2700K		3000K		4000K	
○ F021G2LA001	572,00 €	○ F021G3LA001	572,00 €	○ F021G4LA001	572,00 €
● F021G2LA006	572,00 €	● F021G3LA006	572,00 €	● F021G4LA006	572,00 €
● F021G2LA012	572,00 €	● F021G3LA012	572,00 €	● F021G4LA012	572,00 €
● F021G2LA018	572,00 €	● F021G3LA018	572,00 €	● F021G4LA018	572,00 €
● F021G2LA030	572,00 €	● F021G3LA030	572,00 €	● F021G4LA030	572,00 €
● F021G2LA033	572,00 €	● F021G3LA033	572,00 €	● F021G4LA033	572,00 €

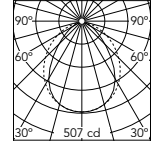

Beam Angle:	90°	
h(m)	E(lx)	D(m)
1	507	1.67
2	127	3.34
3	56	5.00
4	32	6.67
5	20	8.34

@4000K

²Quick Install I H₂O Stop Fast Connect - Schéma électrique n.8 page 669 / Wiring diagram n.8 page 669

2700K		3000K		4000K	
○ F021H2LA001	615,00 €	○ F021H3LA001	615,00 €	○ F021H4LA001	615,00 €
● F021H2LA006	615,00 €	● F021H3LA006	615,00 €	● F021H4LA006	615,00 €
● F021H2LA012	615,00 €	● F021H3LA012	615,00 €	● F021H4LA012	615,00 €
● F021H2LA018	615,00 €	● F021H3LA018	615,00 €	● F021H4LA018	615,00 €
● F021H2LA030	615,00 €	● F021H3LA030	615,00 €	● F021H4LA030	615,00 €
● F021H2LA033	615,00 €	● F021H3LA033	615,00 €	● F021H4LA033	615,00 €

³Continuous Line I/O H₂O Stop Fast Connect - Schéma électrique n.9 page 669 / Wiring diagram n.9 page 669

2700K		3000K		4000K	
○ F021J2LA001	656,00 €	○ F021J3LA001	656,00 €	○ F021J4LA001	656,00 €
● F021J2LA006	656,00 €	● F021J3LA006	656,00 €	● F021J4LA006	656,00 €
● F021J2LA012	656,00 €	● F021J3LA012	656,00 €	● F021J4LA012	656,00 €
● F021J2LA018	656,00 €	● F021J3LA018	656,00 €	● F021J4LA018	656,00 €
● F021J2LA030	656,00 €	● F021J3LA030	656,00 €	● F021J4LA030	656,00 €
● F021J2LA033	656,00 €	● F021J3LA033	656,00 €	● F021J4LA033	656,00 €

Outgraze 50 Easy L 1200 - Non Dimmable

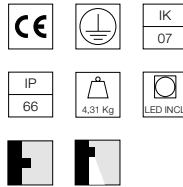
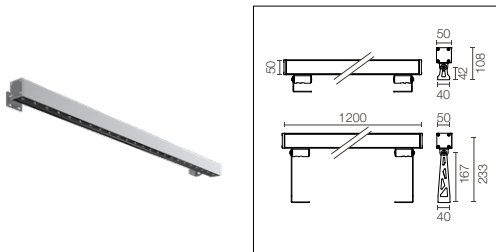

Alimentation 220/240V intégrée.
Supports d'installation à commander séparément.
Verre sablé.

Integrated 220/240V power supply. Installation brackets, to be ordered separately.
Sandblasted glass.

Mid-power Led: 27W - 3224 lm ≠ FIXT 1240 lm - 2700K/CRI 80 - 220-240V / 27W - 3505 lm ≠ FIXT 1348 lm - 3000K/CRI 80 - 220-240V / 27W - 3785 lm ≠ FIXT 1456 lm - 4000K/CRI 80 - 220-240V

¹Standard - Schéma électrique n.7 page 669 / Wiring diagram n.7 page 669

2700K		3000K		4000K	
○ F021G2MA001	674,00 €	○ F021G3MA001	674,00 €	○ F021G4MA001	674,00 €
● F021G2MA006	674,00 €	● F021G3MA006	674,00 €	● F021G4MA006	674,00 €
● F021G2MA012	674,00 €	● F021G3MA012	674,00 €	● F021G4MA012	674,00 €
● F021G2MA018	674,00 €	● F021G3MA018	674,00 €	● F021G4MA018	674,00 €
● F021G2MA030	674,00 €	● F021G3MA030	674,00 €	● F021G4MA030	674,00 €
● F021G2MA033	674,00 €	● F021G3MA033	674,00 €	● F021G4MA033	674,00 €

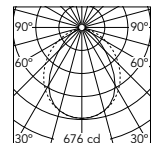

Beam Angle:	90°	
h(m)	E(lx)	D(m)
1	676	1.67
2	169	3.34
3	75	5.00
4	42	6.67
5	27	8.34

@4000K

²Quick Install I H₂O Stop Fast Connect - Schéma électrique n.8 page 669 / Wiring diagram n.8 page 669

2700K		3000K		4000K	
○ F021H2MA001	716,00 €	○ F021H3MA001	716,00 €	○ F021H4MA001	716,00 €
● F021H2MA006	716,00 €	● F021H3MA006	716,00 €	● F021H4MA006	716,00 €
● F021H2MA012	716,00 €	● F021H3MA012	716,00 €	● F021H4MA012	716,00 €
● F021H2MA018	716,00 €	● F021H3MA018	716,00 €	● F021H4MA018	716,00 €
● F021H2MA030	716,00 €	● F021H3MA030	716,00 €	● F021H4MA030	716,00 €
● F021H2MA033	716,00 €	● F021H3MA033	716,00 €	● F021H4MA033	716,00 €

³Continuous Line I/O H₂O Stop Fast Connect - Schéma électrique n.9 page 669 / Wiring diagram n.9 page 669

2700K		3000K		4000K	
○ F021J2MA001	758,00 €	○ F021J3MA001	758,00 €	○ F021J4MA001	758,00 €
● F021J2MA006	758,00 €	● F021J3MA006	758,00 €	● F021J4MA006	758,00 €
● F021J2MA012	758,00 €	● F021J3MA012	758,00 €	● F021J4MA012	758,00 €
● F021J2MA018	758,00 €	● F021J3MA018	758,00 €	● F021J4MA018	758,00 €
● F021J2MA030	758,00 €	● F021J3MA030	758,00 €	● F021J4MA030	758,00 €
● F021J2MA033	758,00 €	● F021J3MA033	758,00 €	● F021J4MA033	758,00 €

Outgraze 50 Easy L 600 - Dimmable DALI

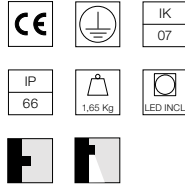
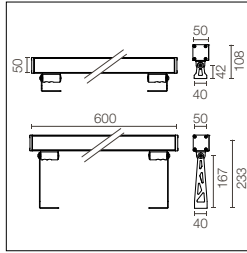

Alimentation 120/240V intégrée.
Supports d'installation à commander séparément.
Verre sablé.

Integrated 120/240V power supply. Installation brackets, to be ordered separately.
Sandblasted glass.

Mid-power Led: 14,5W - 1440 lm ≠ FIXT 1106 lm - 2700K/CRI 80 - 120-240V / 14,5W - 1560 lm ≠ FIXT 1198 lm - 3000K/CRI 80 - 120-240V / 14,5W - 1680 lm ≠ FIXT 1290 lm - 4000K/CRI 80 - 120-240V

²Quick Install I H₂O Stop Fast Connect - Schéma électrique n.10 page 670 / Wiring diagram n.10 page 670

2700K		3000K		4000K	
○ F021G2KD001	601,00 €	○ F021G3KD001	601,00 €	○ F021G4KD001	601,00 €
● F021G2KD006	601,00 €	● F021G3KD006	601,00 €	● F021G4KD006	601,00 €
● F021G2KD012	601,00 €	● F021G3KD012	601,00 €	● F021G4KD012	601,00 €
● F021G2KD018	601,00 €	● F021G3KD018	601,00 €	● F021G4KD018	601,00 €
● F021G2KD030	601,00 €	● F021G3KD030	601,00 €	● F021G4KD030	601,00 €
● F021G2KD033	601,00 €	● F021G3KD033	601,00 €	● F021G4KD033	601,00 €

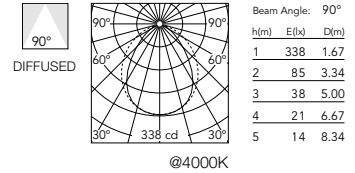

³Continuous Line I/O H₂O Stop Fast Connect - Schéma électrique n.11 page 670 / Wiring diagram n.11 page 670

2700K		3000K		4000K	
○ F021J2KD001	650,00 €	○ F021J3KD001	650,00 €	○ F021J4KD001	650,00 €
● F021J2KD006	650,00 €	● F021J3KD006	650,00 €	● F021J4KD006	650,00 €
● F021J2KD012	650,00 €	● F021J3KD012	650,00 €	● F021J4KD012	650,00 €
● F021J2KD018	650,00 €	● F021J3KD018	650,00 €	● F021J4KD018	650,00 €
● F021J2KD030	650,00 €	● F021J3KD030	650,00 €	● F021J4KD030	650,00 €
● F021J2KD033	650,00 €	● F021J3KD033	650,00 €	● F021J4KD033	650,00 €

Outgraze 50 Easy L 900 - Dimmable DALI

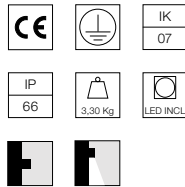
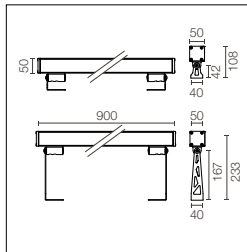

Alimentation 120/240V intégrée.
Supports d'installation à commander séparément.
Verre sablé.

Integrated 120/240V power supply. Installation brackets, to be ordered separately.
Sandblasted glass.

Mid-power Led: 20W - 2418 lm ≠ FIXT 930 lm - 2700K/CRI 80 - 120-240V / 20W - 2628 lm ≠ FIXT 1011 lm - 3000K/CRI 80 - 120-240V / 20W - 2839 lm ≠ FIXT 1092 lm - 4000K/CRI 80 - 120-240V

²Quick Install I H₂O Stop Fast Connect - Schéma électrique n.10 page 670 / Wiring diagram n.10 page 670

2700K		3000K		4000K	
○ F021G2LD001	668,00 €	○ F021G3LD001	668,00 €	○ F021G4LD001	668,00 €
● F021G2LD006	668,00 €	● F021G3LD006	668,00 €	● F021G4LD006	668,00 €
● F021G2LD012	668,00 €	● F021G3LD012	668,00 €	● F021G4LD012	668,00 €
● F021G2LD018	668,00 €	● F021G3LD018	668,00 €	● F021G4LD018	668,00 €
● F021G2LD030	668,00 €	● F021G3LD030	668,00 €	● F021G4LD030	668,00 €
● F021G2LD033	668,00 €	● F021G3LD033	668,00 €	● F021G4LD033	668,00 €

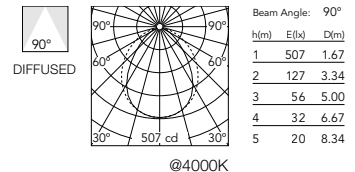

³Continuous Line I/O H₂O Stop Fast Connect - Schéma électrique n.11 page 670 / Wiring diagram n.11 page 670

2700K		3000K		4000K	
○ F021J2LD001	703,00 €	○ F021J3LD001	703,00 €	○ F021J4LD001	703,00 €
● F021J2LD006	703,00 €	● F021J3LD006	703,00 €	● F021J4LD006	703,00 €
● F021J2LD012	703,00 €	● F021J3LD012	703,00 €	● F021J4LD012	703,00 €
● F021J2LD018	703,00 €	● F021J3LD018	703,00 €	● F021J4LD018	703,00 €
● F021J2LD030	703,00 €	● F021J3LD030	703,00 €	● F021J4LD030	703,00 €
● F021J2LD033	703,00 €	● F021J3LD033	703,00 €	● F021J4LD033	703,00 €

²Quick Install In H₂O Stop Version: Connecteur H₂O Stop Plug&Play préinstallé pour connexion rapide (accessoires de connexion à commander séparément) / Prewired H₂O Stop Plug&Play connector for an easy/rapid connection (connecting accessory to be ordered separately).

³Continuous Line In/Out H₂O Stop Version: Connecteurs H₂O Stop Plug&Play préinstallés pour connexion en ligne (accessoires de connexion à commander séparément) / Prewired H₂O Stop Plug&Play connectors for an easy in line connection (connecting accessory to be ordered separately).

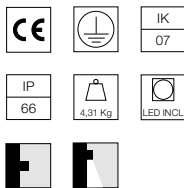
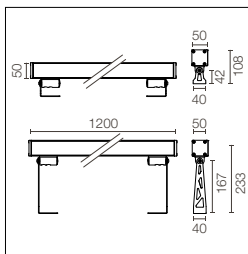

Alimentation 120/240V intégrée.
Supports d'installation à commander séparément.
Verre sablé.

Integrated 120/240V power supply. Installation brackets, to be ordered separately.
Sandblasted glass.

Power Led: 27W - 3224 lm ≠ FIXT 1240 lm - 2700K/CRI 80 - 120-240V / 27W - 3505 lm ≠ FIXT 1348 lm - 3000K/CRI 80 - 120-240V / 27W - 3785 lm ≠ FIXT 1456 lm - 4000K/CRI 80 -120-240V

Quick Install I H₂O Stop Fast Connect - Schéma électrique n.10 page 670 / Wiring diagram n.10 page 670

2700K		3000K		4000K	
○ F021G2MD001	788,00 €	○ F021G3MD001	788,00 €	○ F021G4MD001	788,00 €
● F021G2MD006	788,00 €	● F021G3MD006	788,00 €	● F021G4MD006	788,00 €
● F021G2MD012	788,00 €	● F021G3MD012	788,00 €	● F021G4MD012	788,00 €
● F021G2MD018	788,00 €	● F021G3MD018	788,00 €	● F021G4MD018	788,00 €
● F021G2MD030	788,00 €	● F021G3MD030	788,00 €	● F021G4MD030	788,00 €
● F021G2MD033	788,00 €	● F021G3MD033	788,00 €	● F021G4MD033	788,00 €

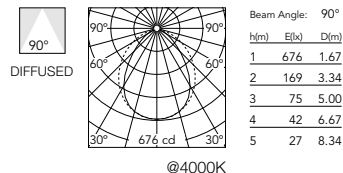

Continuous Line I/O H₂O Stop Fast Connect - Schéma électrique n.11 page 670 / Wiring diagram n.11 page 670

2700K		3000K		4000K	
○ F021J2MD001	818,00 €	○ F021J3MD001	818,00 €	○ F021J4MD001	818,00 €
● F021J2MD006	818,00 €	● F021J3MD006	818,00 €	● F021J4MD006	818,00 €
● F021J2MD012	818,00 €	● F021J3MD012	818,00 €	● F021J4MD012	818,00 €
● F021J2MD018	818,00 €	● F021J3MD018	818,00 €	● F021J4MD018	818,00 €
● F021J2MD030	818,00 €	● F021J3MD030	818,00 €	● F021J4MD030	818,00 €
● F021J2MD033	818,00 €	● F021J3MD033	818,00 €	● F021J4MD033	818,00 €

²Quick Install In H₂O Stop Version: Connecteur H₂O Stop Plug&Play préinstallé pour connexion rapide (accessoires de connexion à commander séparément) / Prewired H₂O Stop Plug&Play connector for an easy/rapid connection (connecting accessory to be ordered separately).

³Continuous Line In/Out H₂O Stop Version: Connecteurs H₂O Stop Plug&Play préinstallés pour connexion en ligne (accessoires de connexion à commander séparément) / Prewired H₂O Stop Plug&Play connectors for an easy in line connection (connecting accessory to be ordered separately).

Outgraze 50 Easy - Tunable White DALI 2700K÷5700K

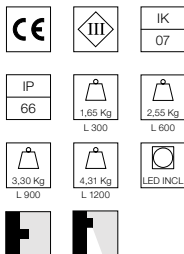
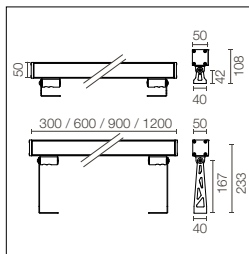
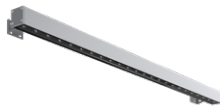

Alimentation électrique à distance 24V et supports d'installation à commander séparément.
Verre sablé.

24V remote power supply and installation brackets to be ordered separately.
Sandblasted glass.

Mid-power Led: L300: 6,5W - 572 lm ≠ FIXT 220 lm - 2700K/CRI 80 - 24V / L600: 11W - 1143 lm ≠ FIXT 440 lm - 2700K/CRI 80 - 24V / L900: 16W - 1715 lm ≠ FIXT 660 lm - 2700K/CRI 80 - 24V / L1200: 21W - 2286 lm ≠ FIXT 879 lm - 2700K/CRI 80 - 24V

2Quick Install I H₂O Stop Fast Connect - Schéma électrique n.13 page 671 / Wiring diagram n.13 page 671

- L 300**
- F021KTJD001 830,00 €
 - F021KTJD006 830,00 €
 - F021KTJD012 830,00 €
 - F021KTJD018 830,00 €
 - F021KTJD030 830,00 €
 - F021KTJD033 830,00 €

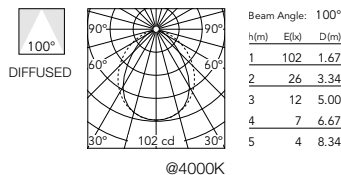

2Quick Install I H₂O Stop Fast Connect - Schéma électrique n.13 page 671 / Wiring diagram n.13 page 671

- L 600**
- F021KTKD001 961,00 €
 - F021KTKD006 961,00 €
 - F021KTKD012 961,00 €
 - F021KTKD018 961,00 €
 - F021KTKD030 961,00 €
 - F021KTKD033 961,00 €

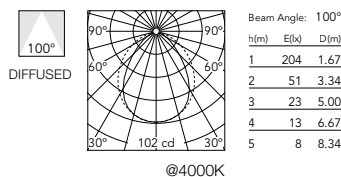

3Continuous Line I/O H₂O Stop Fast Connect - Schéma électrique n.14 page 671 / Wiring diagram n.14 page 671

- L 600**
- F021LTKD001 1.004,00 €
 - F021LTKD006 1.004,00 €
 - F021LTKD012 1.004,00 €
 - F021LTKD018 1.004,00 €
 - F021LTKD030 1.004,00 €
 - F021LTKD033 1.004,00 €

2Quick Install I H₂O Stop Fast Connect - Schéma électrique n.13 page 671 / Wiring diagram n.13 page 671

- L 900**
- F021KTLD001 1.154,00 €
 - F021KTLD006 1.154,00 €
 - F021KTLD012 1.154,00 €
 - F021KTLD018 1.154,00 €
 - F021KTLD030 1.154,00 €
 - F021KTLD033 1.154,00 €

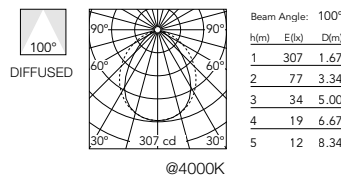

3Continuous Line I/O H₂O Stop Fast Connect - Schéma électrique n.14 page 671 / Wiring diagram n.14 page 671

- L 900**
- F021LTLD001 1.195,00 €
 - F021LTLD006 1.195,00 €
 - F021LTLD012 1.195,00 €
 - F021LTLD018 1.195,00 €
 - F021LTLD030 1.195,00 €
 - F021LTLD033 1.195,00 €

2Quick Install I H₂O Stop Fast Connect - Schéma électrique n.13 page 671 / Wiring diagram n.13 page 671

- L 1200**
- F021KTMD001 1.380,00 €
 - F021KTMD006 1.380,00 €
 - F021KTMD012 1.380,00 €
 - F021KTMD018 1.380,00 €
 - F021KTMD030 1.380,00 €
 - F021KTMD033 1.380,00 €

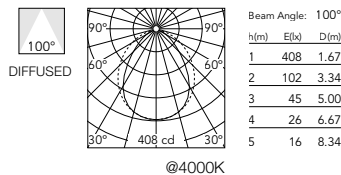

3Continuous Line I/O H₂O Stop Fast Connect - Schéma électrique n.14 page 671 / Wiring diagram n.14 page 671







- L 1200**
- F021LTMD001 1.416,00 €
 - F021LTMD006 1.416,00 €
 - F021LTMD012 1.416,00 €
 - F021LTMD018 1.416,00 €
 - F021LTMD030 1.416,00 €
 - F021LTMD033 1.416,00 €

²Quick Install In H₂O Stop Version: Connecteur H₂O Stop Plug&Play préinstallé pour connexion rapide (accessoires de connexion à commander séparément) / Prewired H₂O Stop Plug&Play connector for an easy/rapid connection (connecting accessory to be ordered separately).

³Continuous Line In/Out H₂O Stop Version: Connecteurs H₂O Stop Plug&Play préinstallés pour connexion en ligne (accessoires de connexion à commander séparément) / Prewired H₂O Stop Plug&Play connectors for an easy in line connection (connecting accessory to be ordered separately).

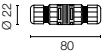
Outgraze 50

Accessoires pour toutes les versions / Accessories for all versions

Jeu de supports courts L 80 mm.	One pair of short brackets L 80 mm.	<ul style="list-style-type: none"> ○ F1203001 41,00 € ● F1203006 41,00 € ● F1203012 41,00 € ● F1203018 41,00 € ● F1203030 41,00 € ● F1203033 41,00 € 		
Jeu de supports longs L 200 mm.	One pair of long brackets L 200 mm.	<ul style="list-style-type: none"> ○ F1204001 59,00 € ● F1204006 59,00 € ● F1204012 59,00 € ● F1204018 59,00 € ● F1204030 59,00 € ● F1204033 59,00 € 		
Système de jonction IP68 H ₂ O Stop anti-condensation à 2 voies 4 pôles. (Ø5,5÷12mm câble).	2 way terminal block 4 poles IP68 H ₂ O Stop. (ø5,5÷12mm cable).	F990C00A000	33,00 €	 
Système de jonction IP68 H ₂ O Stop anti-condensation à 3/4 voies 4 pôles. (Ø5,5÷12mm câble).	3/4 way terminal block 4 poles IP68 H ₂ O Stop. (ø5,5÷12mm cable).	F990C010000	60,00 €	
Kit de connecteurs à 5 pôles: fiche volante + fiche EU IP68.	Connector kit 5-pole flying socket + EU plug IP68.	F990C080000	48,00 €	
Embout pour connecteur panneau (sur l'appareil) 4-5 pôles.	Cap for panel (on the fixtures) plug connector 4-5 poles.	F021Z070000	10,00 €	



Outgraze 50

Accessoires pour les versions Non Dimmable (220-240V) et Easy Non Dimmable (220-240V) / Accessories for Non Dimmable (220-240V) and Easy Non Dimmable (220-240V) versions

Connecteur 4 pôles Plug&Play.	Plug&play connector 4 poles.	F021Z010000	23,00 €	
Double connecteur 4 pôles Plug&Play + câble L. 600 mm.	Double plug&play connector 4 poles + cable 600 mm lenght.	F021Z020000	87,00 €	
Connecteur 4 pôles Plug&Play + câble L. 5000 mm.	Plug&play connector 4 poles + cable 5000 mm lenght.	F021Z030000	116,00 €	





Outgraze 50

Accessoires pour les versions Quick Install I H₂O Stop, Continuous Line I/O H₂O Stop et Easy Tunable White (24V) / Accessories for Quick Install I H₂O Stop, Continuous Line I/O H₂O Stop and Easy Tunable White (24V) versions

Connecteur 4 pôles Plug&Play.	Plug&play connector 4 poles.	F021Z010000	23,00 €	
Double connecteur 4 pôles Plug&Play + câble L. 600 mm. Classe III.	Double plug&play connector 4 poles + cable 600 mm lenght. Class III.	F021Z090000	87,00 €	
Connecteur 4 pôles Plug&Play + câble L. 5000 mm. Classe III.	Plug&play connector 4 poles + cable 5000 mm lenght. Class III.	F021Z100000	116,00 €	





Outgraze 50

Accessoires pour les versions Quick Install I H2O Stop, Continuous Line I/O H2O Stop Dimmable DALI, Easy Dimmable et Tunable White DALI (120-240V) / Accessories for Quick Install I H2O Stop, Continuous Line I/O H2O Stop Dimmable DALI, Easy Dimmable and Tunable White DALI (120-240V) versions

Connecteur 5 pôles Plug&Play.	Plug&play connector 5 poles.	F021Z040000	26,00 €	
Connecteur 5 pôles Plug&Play + câble L. 5000 mm.	Plug&play connector 5 poles + cable 5000 mm length.	F021Z060000	116,00 €	
Double connecteur 5 pôles Plug&Play + câble L. 600 mm.	Double plug&play connector 5 poles + cable 600 mm length.	F021Z050000	87,00 €	
Boitier de dérivation 5 pôles 4 voies (câbles 6-14 mm).	4 way junction box 5 poles IP68 (6-14 mm cables).	F990C030000	62,00 €	

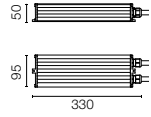
Outgraze 50

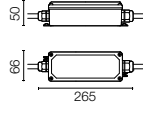
Alimentations pour la version Easy Tunable White DALI (24V) / Powers supplies for Easy Tunable White DALI (24V) version

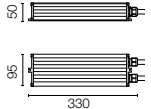
Équipement d'alimentation pour installation à distance 24V DC 50W / 120-240V IP67 Classe II selv.	Power supply for remote installation 24V DC 50W / 120-240V IP67 Class II selv.	F990B28A000	251,00 €		
Équipement d'alimentation pour installation à distance 24V DC 70W / 220-240V IP67 Classe II selv.	Power supply for remote installation 24V DC 70W / 220-240V IP67 Class II selv.	F990B27A000	212,00 €		
Équipement d'alimentation pour installation à distance 24V DC 96W / 120-240V IP67 Classe II selv.	Power supply for remote installation 24V DC 96W / 120-240V IP67 Class II selv.	F990B29A000	300,00 €		

Outgraze 50

Accessoires pour gestion RGB-RGBW / Accessories for RGB-RGBW management

Contrôleur DMX pour boîtes encastrables. (60 mm d'entraxe)	DMX controller; dimmer switch for recessed box (60mm hole centres).	F990B10A000	1.006,00 €		
Contrôleur DMX. Interface stand/alone pc.	DMX controller; stand-alone/pc interface.	F990B11A000	1.306,00 €		
DMX splitter 512- dispositif électronique pour régénérer le signal dmx monodirectionnel. 1 entrée et 7 sorties, 12-24 Vdc. Source d'alimentation non incluse.	DMX splitter 512 - electronic device to regenerate the monodirectional DMX signal 1 Input and 7 output, 12-24Vdc. Power supply not included.	F990B13A000	227,00 €		
Équipement d'alimentation 24V 10W / 110-240V IP20 Classe II selv.	Power supply 24V 10W / 110-240V IP20 Class II selv.	RF25747	48,00 €		
Câble DMX blindé à impédance constante 110 Ohm.	DMX cable - shielded twisted pair with 110 Ohm constant impedance.	F990B12A000	19,00 €		

Outgraze 50

Non Dimmable and Easy Non Dimmable versions

Schéma électrique n.7 / Wiring diagram n.7

Standard: câble en sortie long. 1000 mm (accessoires de connexion à commander séparément) / 1000 mm lenght prewired cable (connecting accessory to be separately ordered)

220-240V



Schéma électrique n.8 / Wiring diagram n.8

Quick Install I H₂O Stop Fast Connect: connecteur H₂O Stop Plug&Play préinstallé pour connexion rapide (accessoires de connexion à commander séparément) / Prewired H₂O Stop Plug&Play connector for an easy/rapid connection (connecting accessory to be ordered separately)

220-240V

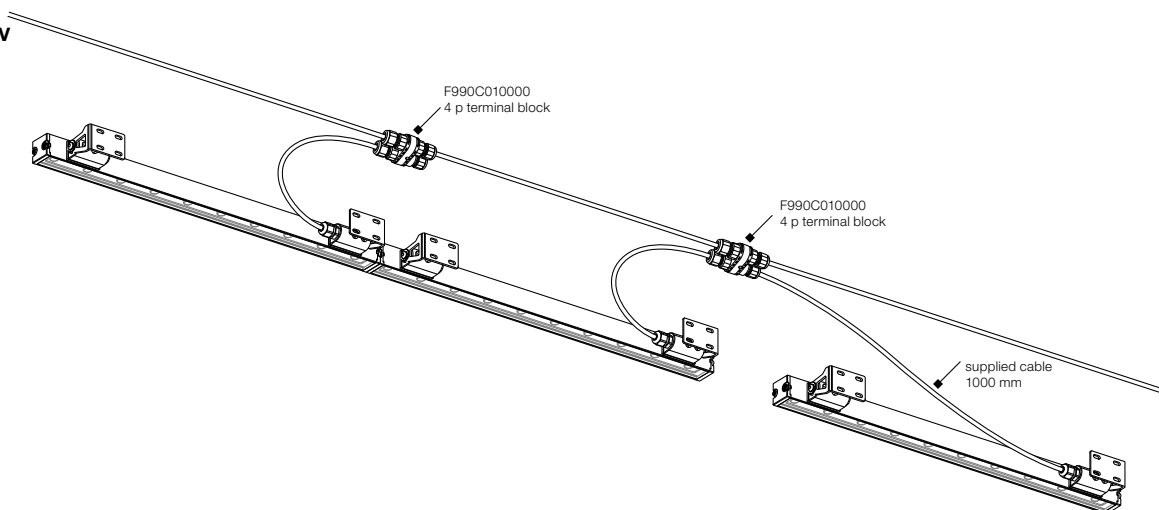

Schéma électrique n.9 / Wiring diagram n.9

Continous Line I/O H₂O Stop Fast Connect: connecteurs H₂O Stop Plug&Play préinstallés pour connexion en ligne (accessoires de connexion à commander séparément) / Prewired H₂O Stop Plug&Play connectors for an easy in line connection (connecting accessory to be ordered separately)

220-240V

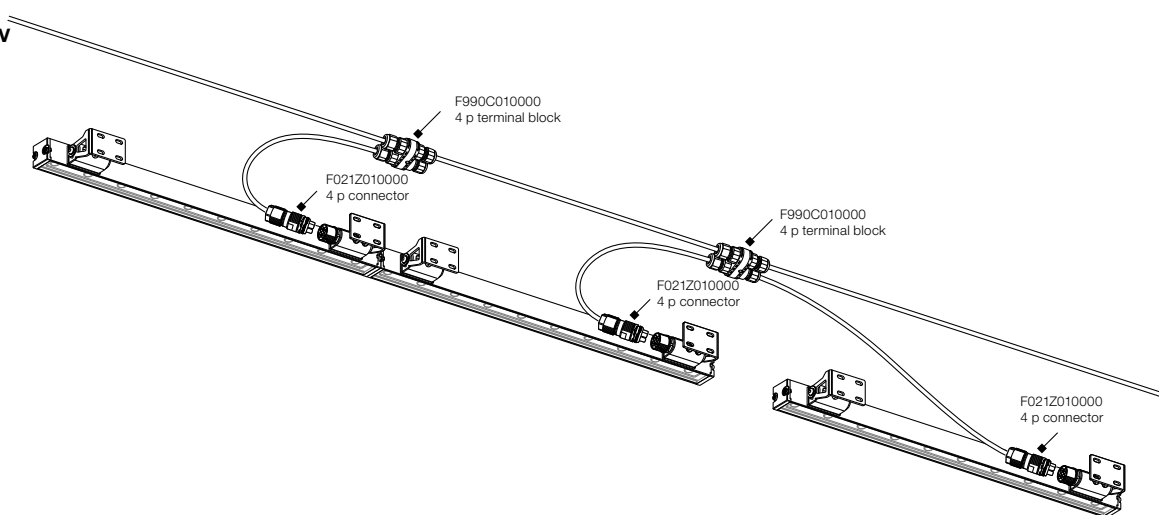
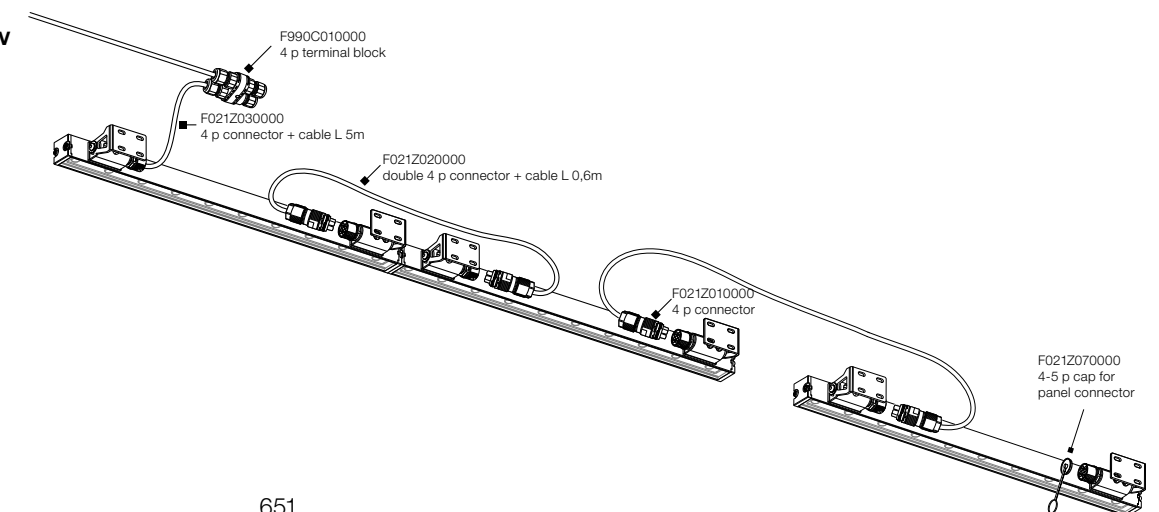

Outgraze 50

Standard Dimmable versions and Tunable White (120-240V) and Dimmable Easy versions

For Dimmable and Tunable White versions

Schéma électrique n.10 / Wiring diagram n.10

Quick Install I H₂O Stop: connecteur H₂O Stop Plug&Play préinstallé pour connexion rapide (accessoires de connexion à commander séparément) / Prewired H₂O Stop Plug&Play connector for an easy/rapid connection (connecting accessory to be ordered separately)

120-240V

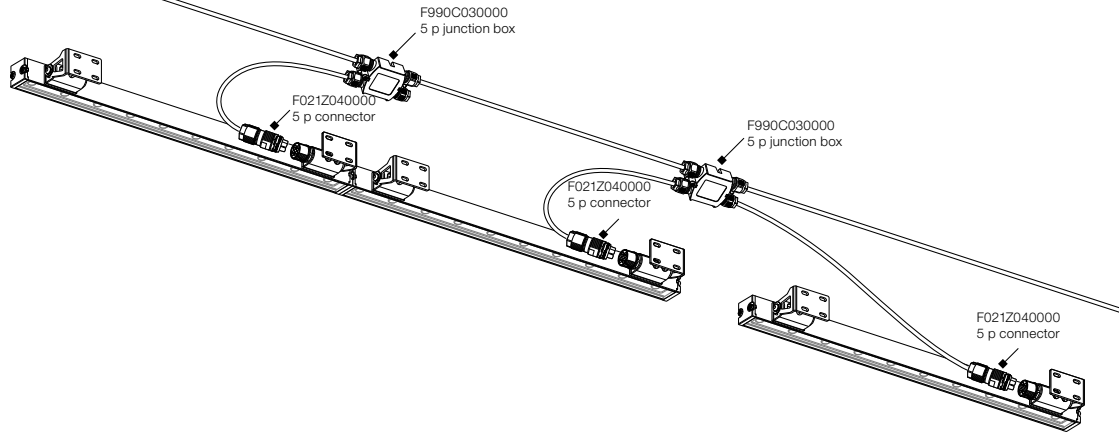

For Dimmable and Tunable White versions

Schéma électrique n.11 / Wiring diagram n.11

Continuous Line I/O H₂O Stop Fast Connect: connecteurs H₂O Stop Plug&Play préinstallés pour connexion en ligne (accessoires de connexion à commander séparément) / Prewired H₂O Stop Plug&Play connectors for an easy in line connection (connecting accessory to be ordered separately)

120-240V

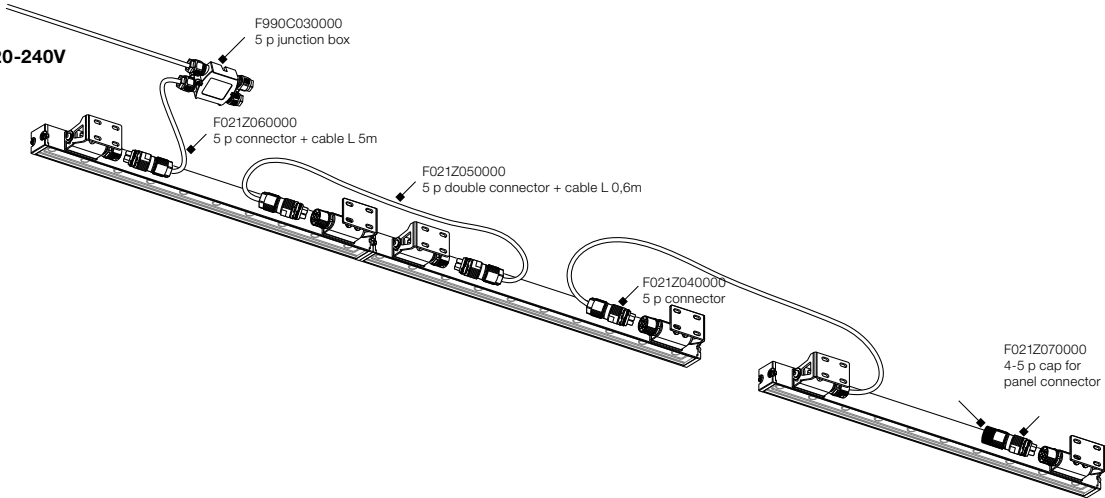

For RGB-RGBW versions

Schéma électrique n.12 / Wiring diagram n.12

Connecteurs IP68 Plug&Play préinstallés / Prewired IP68 Plug&Play connectors

120-240V

BUS DMX

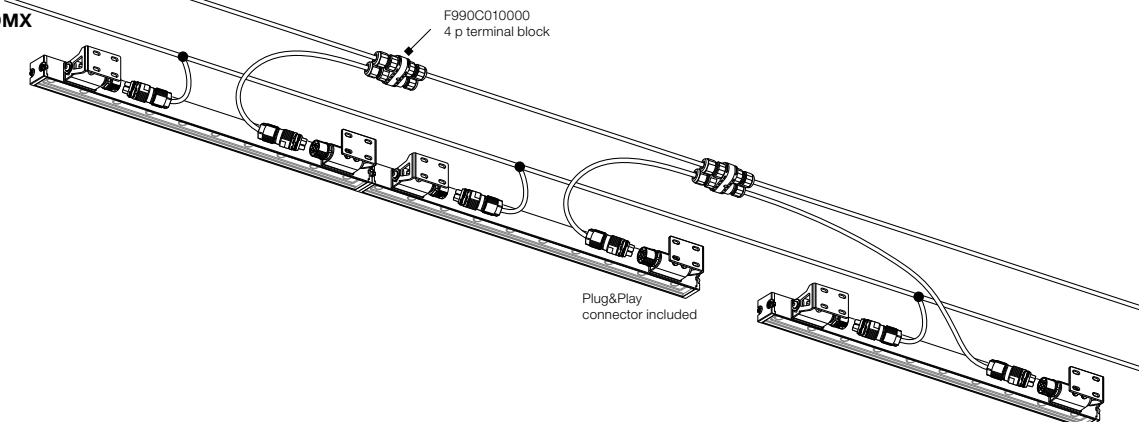

Easy Tunable White 24V versions

For Easy Tunable White versions

Schéma électrique n.13 / Wiring diagram n.13

Quick Install I H₂O Stop Fast Connect: connecteur H₂O Stop Plug&Play préinstallé pour connexion rapide (accessoires de connexion à commander séparément) / Prewired H₂O Stop Plug&Play connector for an easy/rapid connection (connecting accessory to be ordered separately)

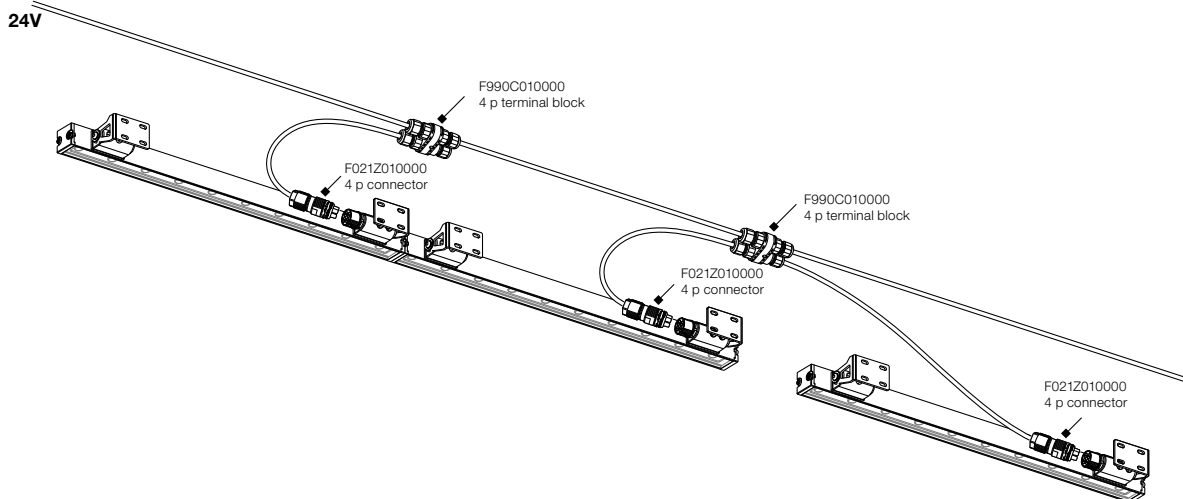

For Easy Tunable White versions

Schéma électrique n.14 / Wiring diagram n.14

Continous Line I/O H₂O Stop Fast Connect: connecteurs H₂O Stop Plug&Play préinstallés pour connexion en ligne (accessoires de connexion à commander séparément) / Prewired H₂O Stop Plug&Play connectors for an easy in line connection (connecting accessory to be ordered separately)

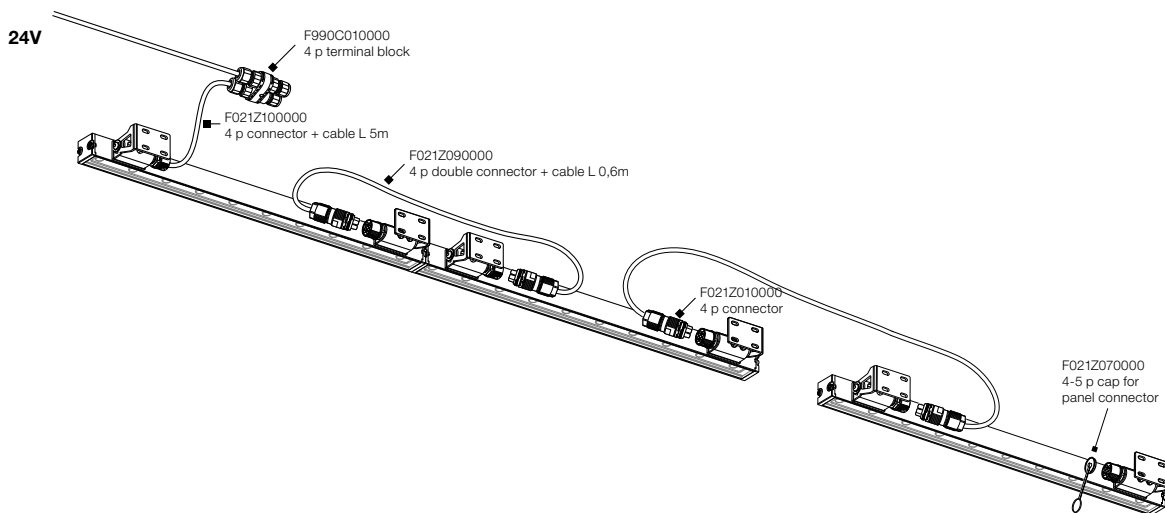

Tau



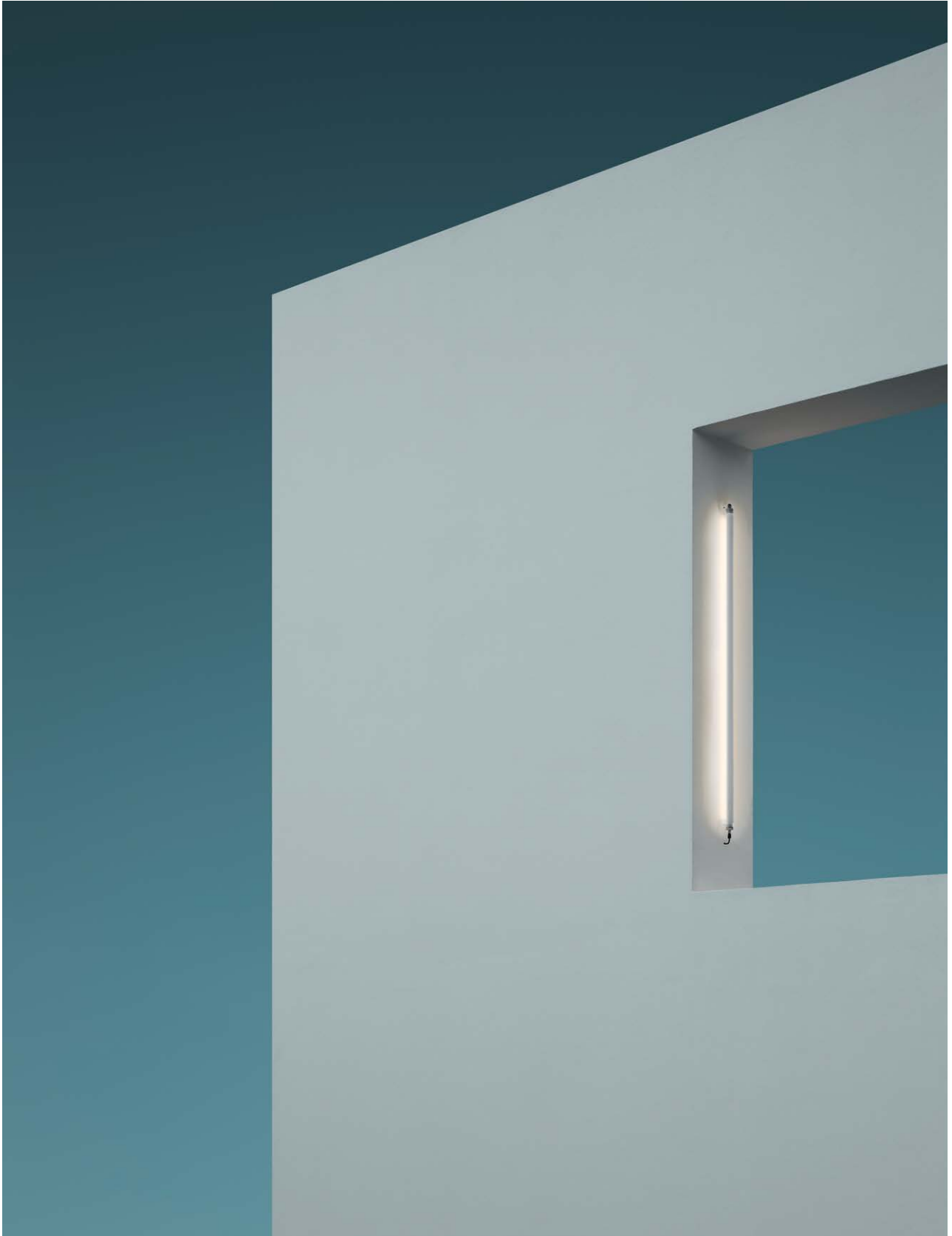

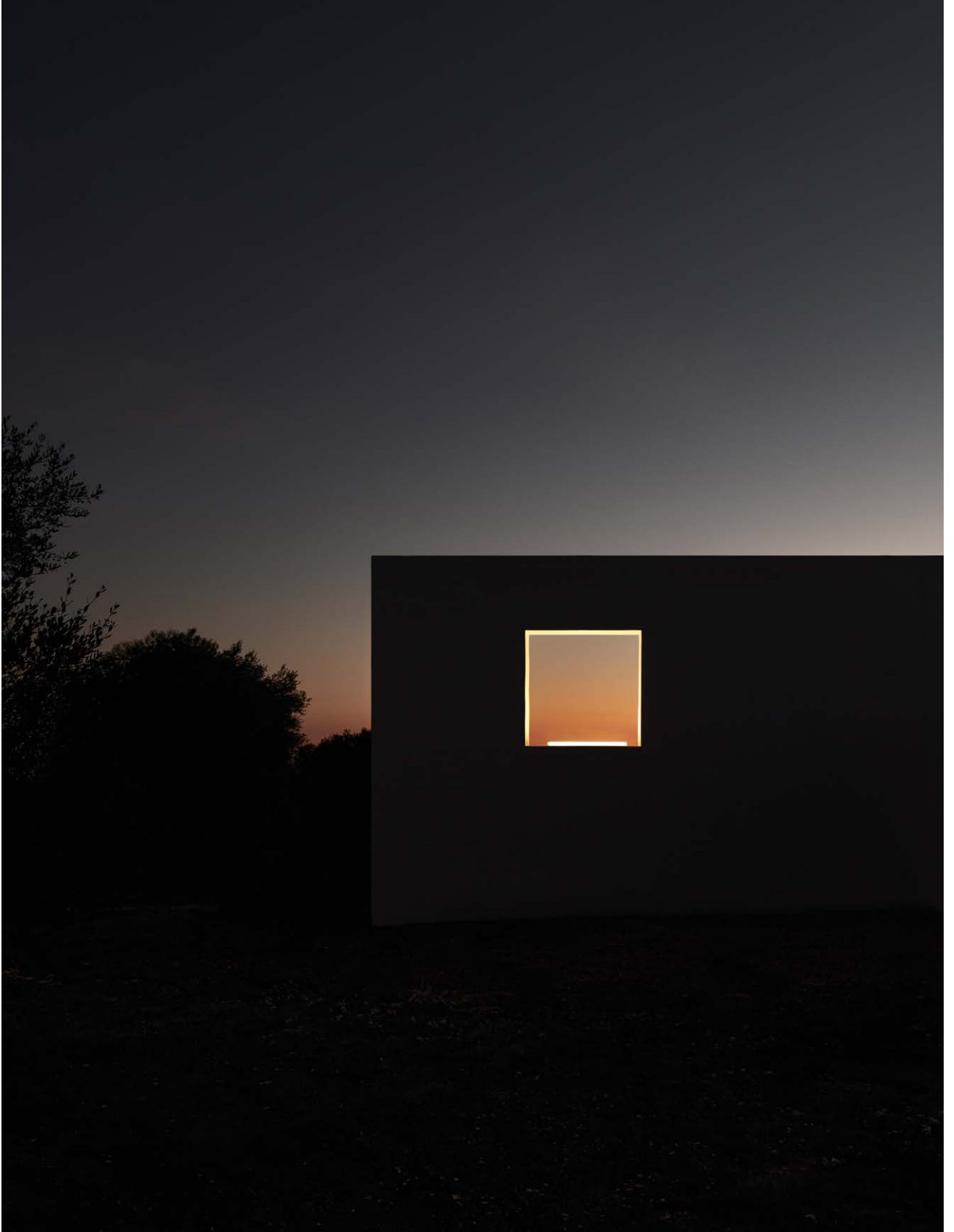

Famille / Family

Tau L 354



Low Power Led

up to 3W
up to 231 lm - 2700K/CRI 80
up to 231 lm - 3000K/CRI 80
up to 231 lm - 4000K/CRI 80
* Net lumen output

Tau Opal L 354



Low Power Led

up to 3W
up to 118 lm - 2700K/CRI 80
up to 118 lm - 3000K/CRI 80
up to 118 lm - 4000K/CRI 80
* Net lumen output

Tau L 554



Low Power Led

up to 5W
up to 384 lm - 2700K/CRI 80
up to 384 lm - 3000K/CRI 80
up to 384 lm - 4000K/CRI 80
* Net lumen output

Tau Opal L 554



Low Power Led

up to 5W
up to 196 lm - 2700K/CRI 80
up to 196 lm - 3000K/CRI 80
up to 196 lm - 4000K/CRI 80
* Net lumen output

Tau L 1054



Low Power Led

up to 10W
up to 768 lm - 2700K/CRI 80
up to 768 lm - 3000K/CRI 80
up to 768 lm - 4000K/CRI 80
* Net lumen output

Tau Opal L 1054



Low Power Led

up to 10W
up to 392 lm - 2700K/CRI 80
up to 392 lm - 3000K/CRI 80
up to 392 lm - 4000K/CRI 80
* Net lumen output

Tau L 1554



Low Power Led

up to 15W
up to 1152 lm - 2700K/CRI 80
up to 1152 lm - 3000K/CRI 80
up to 1152 lm - 4000K/CRI 80
* Net lumen output

Tau Opal L 1554



Low Power Led

up to 15W
up to 589 lm - 2700K/CRI 80
up to 589 lm - 3000K/CRI 80
up to 589 lm - 4000K/CRI 80
* Net lumen output

Description / Description

Luminaire linéaire avec source LED pour être installé au mur ou au plafond. Structure formée par un tube en polycarbonate avec filtre anti-UV, disponible en quatre longueurs et avec finition opale ou transparente. Équerres de maintien en polycarbonate dépoli et couvercles en aluminium anodisé. Équipé de raccords filetés sur les extrémités du tube qui nécessitent un câble d'alimentation, à commander séparément. Équipé d'un câble de 2 m pour une connexion directe à la source d'alimentation, ou de deux câbles de 8 cm ou de 20 cm pour une connexion en série. La longueur maximale de l'installation en série est de 5 m. Le luminaire en 24V dc nécessite une source d'alimentation à distance à commander séparément.

Linear luminaire with LED light source, for installation on wall or ceiling. Polycarbonate tube structure with anti-UV filter. It is available in four lengths and opal or transparent finishes. Frosted polycarbonate fixing brackets and anodized aluminium closing caps. Equipped with screw connectors at the tube's ends which require the use of a feeding cable to be ordered separately. It is supplied with a 2 m cable for a direct connection to the power supply or two 8 cm or 20 cm cables for series connection. Maximum length for in series installation is 5 m. The 24 V dc luminaire is powered by a remote power supply to be ordered separately.

Tau L 354

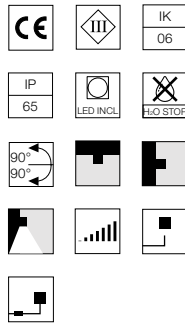
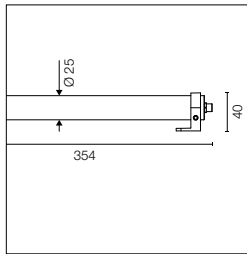

Source LED incluse. Raccord fileté sur l'extrémité du tube. Source d'alimentation électrique à distance 24V dc et câbles d'alimentation, individuels ou en série, à commander séparément. Diffuseur en polycarbonate transparent. Intensité réglable.

LED light source included. Screw connector at the tube's end. 24V dc remote electric power supply and individual or series feeding cables, to be ordered separately. Transparent polycarbonate diffuser. Adjustable light intensity.

Low - Power Led: 3W - 255 lm ≠ OUTPUT 231 lm - 2700K/CRI 80 - 24Vdc / 3W - 255 lm ≠ OUTPUT 231 lm - 3000K/CRI 80 - 24Vdc / 3W - 255 lm ≠ OUTPUT 231 lm - 4000K/CRI 80 - 24Vdc

2700K

FA523203.A 173,00 €

3000K

FA523003.A 173,00 €

4000K

FA523002.A 173,00 €

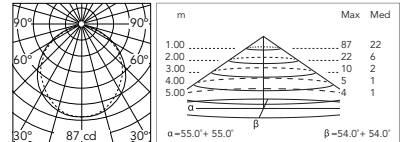

@ 4000K

Tau Opal L 354

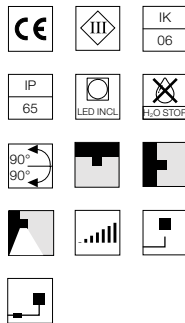
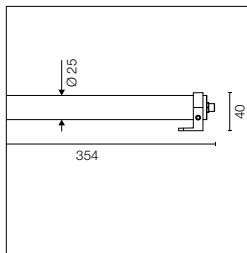

Source LED incluse. Raccord fileté sur l'extrémité du tube. Source d'alimentation électrique à distance 24V dc et câbles d'alimentation, individuels ou en série, à commander séparément. Diffuseur en polycarbonate opale. Intensité réglable.

LED light source included. Screw connector at the tube's end. 24V dc remote electric power supply and individual or series feeding cables, to be ordered separately. Opal polycarbonate diffuser. Adjustable light intensity.

Low - Power Led: 3W - 255 lm ≠ OUTPUT 118 lm - 2700K/CRI 80 - 24Vdc / 3W - 255 lm ≠ OUTPUT 118 lm - 3000K/CRI 80 - 24Vdc / 3W - 255 lm ≠ OUTPUT 118 lm - 4000K/CRI 80 - 24Vdc

2700K

FA523213 173,00 €

3000K

FA523013.A 173,00 €

4000K

FA523012.A 173,00 €

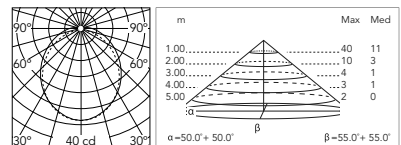

@ 4000K

* Nombre maximum de luminaires par source d'alimentation / Maximum number of luminaires per power supply.

Nombre maximum de luminaires par source d'alimentation (220-240 V). Ces données doivent être vérifiées en prenant en compte les conditions spécifiques d'installation.

Maximum number of luminaires per power supply. (220-240 V). These data must be checked taking into account the specific installation conditions.

Acc. RF25754	2	Acc. RF26387.A	5
Acc. RF25748	2	Acc. RF25752	6
Acc. RF25747	3	Acc. F990B28A000	16
Acc. RF25757	3	Acc. F990B27A000	22
Acc. RF25750	5	Acc. F990B29A000	30
Acc. F990B21A000	5		

Tau L 554

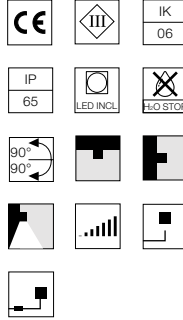
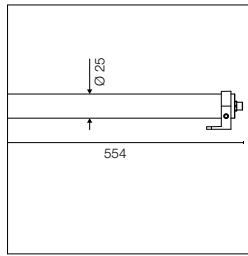

Source LED incluse. Raccord fileté sur l'extrémité du tube.
Source d'alimentation électrique à distance 24V dc et câbles d'alimentation, individuels ou en série, à commander séparément.
Diffuseur en polycarbonate transparent
Intensité réglable.

LED light source included. Screw connector at the tube's end. 24V dc remote electric power supply and individual or series feeding cables, to be ordered separately
Transparent polycarbonate diffuser.
Adjustable light intensity.

Low - Power Led: 5W - 420 lm ≠ OUTPUT 384 lm - 2700K/CRI 80 - 24Vdc / 5W - 420 lm ≠ OUTPUT 384 lm - 3000K/CRI 80 - 24Vdc / 5W - 420 lm ≠ OUTPUT 384 lm - 4000K/CRI 80 - 24Vdc

2700K

FA523223 186,00 €

3000K

FA523023.A 186,00 €

4000K

FA523022.A 186,00 €

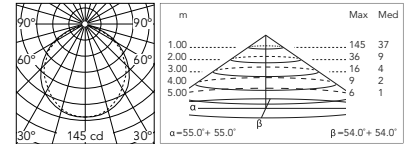

@ 4000K

Tau Opal L 554

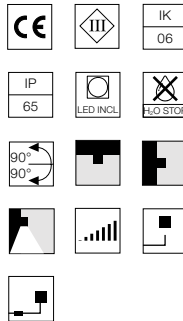
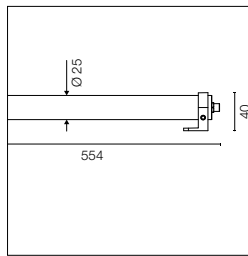

Source LED incluse. Raccord fileté sur l'extrémité du tube.
Source d'alimentation électrique à distance 24V dc et câbles d'alimentation, individuels ou en série, à commander séparément.
Diffuseur en polycarbonate opale.
Intensité réglable.

LED light source included. Screw connector at the tube's end. 24V dc remote electric power supply and individual or series feeding cables, to be ordered separately
Opal polycarbonate diffuser.
Adjustable light intensity.

Low - Power Led: 5W - 420 lm ≠ OUTPUT 196 lm - 2700K/CRI 80 - 24Vdc / 5W - 420 lm ≠ OUTPUT 196 lm - 3000K/CRI 80 - 24Vdc / 5W - 420 lm ≠ OUTPUT 196 lm - 4000K/CRI 80 - 24Vdc

2700K

FA523233 186,00 €

3000K

FA523033.A 186,00 €

4000K

FA523032.A 186,00 €

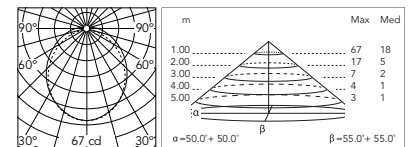

@ 4000K

* Nombre maximum de luminaires par source d'alimentation / Maximum number of luminaires per power supply.

Nombre maximum de luminaires par source d'alimentation (220-240 V). Ces données doivent être vérifiées en prenant en compte les conditions spécifiques d'installation.

Maximum number of luminaires per power supply. (220-240 V). These data must be checked taking into account the specific installation conditions.

Acc. RF25754	1
Acc. RF25748	1
Acc. RF25747	2
Acc. RF25757	2
Acc. RF25750	3
Acc. F990B21A000	3

Acc. RF26387.A	3
Acc. RF25752	4
Acc. F990B28A000	10
Acc. F990B27A000	14
Acc. F990B29A000	18

Tau L 1054

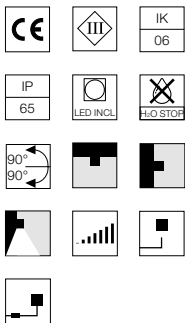
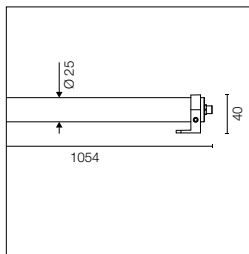

Source LED incluse. Raccord fileté sur l'extrémité du tube.
 Source d'alimentation électrique à distance 24V dc et câbles d'alimentation, individuels ou en série, à commander séparément.
 Diffuseur en polycarbonate transparent
 Intensité réglable.

LED light source included. Screw connector at the tube's end. 24V dc remote electric power supply and individual or series feeding cables, to be ordered separately
 Transparent polycarbonate diffuser.
 Adjustable light intensity.

Low - Power Led: 10W - 840 lm ≠ OUTPUT 768 lm - 2700K/CRI 80 - 24Vdc / 10W - 840 lm ≠ OUTPUT 768 lm - 3000K/CRI 80 - 24Vdc / 10W - 840 lm ≠ OUTPUT 768 lm - 4000K/CRI 80 - 24Vdc

2700K FA523243 217,00 € **3000K** FA523043.A 217,00 € **4000K** FA523042.A 217,00 €

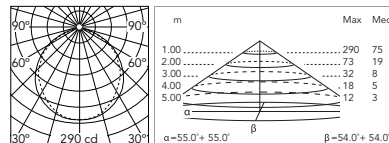

@ 4000K

Tau Opal L 1054

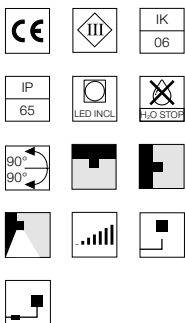
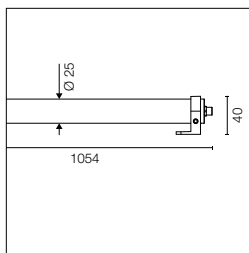

Source LED incluse. Raccord fileté sur l'extrémité du tube.
 Source d'alimentation électrique à distance 24V dc et câbles d'alimentation, individuels ou en série, à commander séparément.
 Diffuseur en polycarbonate opale.
 Intensité réglable.

LED light source included. Screw connector at the tube's end. 24V dc remote electric power supply and individual or series feeding cables, to be ordered separately
 Opal polycarbonate diffuser.
 Adjustable light intensity.

Low - Power Led: 10W - 840 lm ≠ OUTPUT 393 lm - 2700K/CRI 80 - 24Vdc / 10W - 840 lm ≠ OUTPUT 393 lm - 3000K/CRI 80 - 24Vdc / 10W - 840 lm ≠ OUTPUT 393 lm - 4000K/CRI 80 - 24Vdc

2700K FA523253.A 217,00 € **3000K** FA523053.A 217,00 € **4000K** FA523052.A 217,00 €

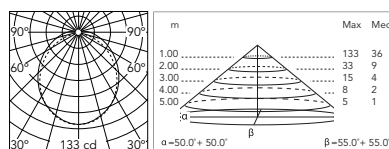

@ 4000K

* Nombre maximum de luminaires par source d'alimentation / Maximum number of luminaires per power supply.

Nombre maximum de luminaires par source d'alimentation (220÷240 V). Ces données doivent être vérifiées en prenant en compte les conditions spécifiques d'installation.	Maximum number of luminaires per power supply. (220÷240 V). These data must be checked taking into account the specific installation conditions.	Acc. RF25750	1	Acc. F990B21A000	1	Acc. F990B28A000	5
		Acc. RF26387.A	1	Acc. F990B27A000	7	Acc. F990B29A000	9
		Acc. RF25752	2				

Tau L 1554

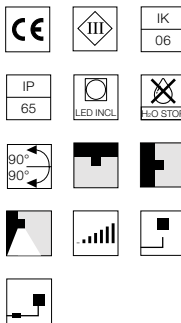
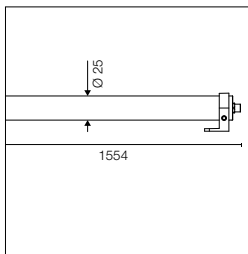

Source LED incluse. Raccord fileté sur l'extrémité du tube.
 Source d'alimentation électrique à distance 24V dc et câbles d'alimentation, individuels ou en série, à commander séparément.
 Diffuseur en polycarbonate transparent
 Intensité réglable.

LED light source included. Screw connector at the tube's end. 24V dc remote electric power supply and individual or series feeding cables, to be ordered separately
 Transparent polycarbonate diffuser.
 Adjustable light intensity.

Low - Power Led: 15W - 1260 lm ≠ OUTPUT 1152 lm - 2700K/CRI 80 - 24Vdc / 15W - 1260 lm ≠ OUTPUT 1152 lm - 3000K/CRI 80 - 24Vdc / 15W - 1260 lm ≠ OUTPUT 1152 lm - 4000K/CRI 80 - 24Vdc

2700K

FA523263 231,00 €

3000K

FA523063.A 231,00 €

4000K

FA523062.A 231,00 €

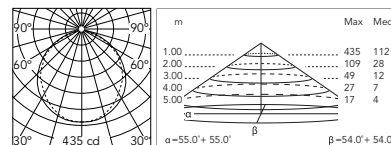

@ 4000K

Tau Opal L 1554

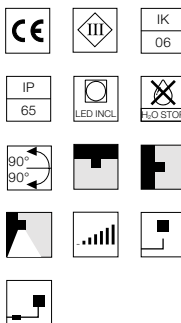
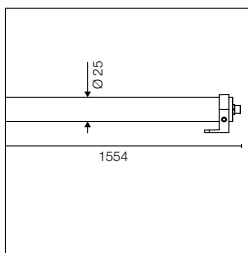

Source LED incluse. Raccord fileté sur l'extrémité du tube.
 Source d'alimentation électrique à distance 24V dc et câbles d'alimentation, individuels ou en série, à commander séparément.
 Diffuseur en polycarbonate opale.
 Intensité réglable.

LED light source included. Screw connector at the tube's end. 24V dc remote electric power supply and individual or series feeding cables, to be ordered separately
 Opal polycarbonate diffuser.
 Adjustable light intensity.

Low - Power Led: 15W - 1260 lm ≠ OUTPUT 589 lm - 2700K/CRI 80 - 24Vdc / 15W - 1260 lm ≠ OUTPUT 589 lm - 3000K/CRI 80 - 24Vdc / 15W - 1260 lm ≠ OUTPUT 589 lm - 4000K/CRI 80 - 24Vdc

2700K

FA523273 231,00 €

3000K

FA523073.A 231,00 €

4000K

FA523072.A 231,00 €

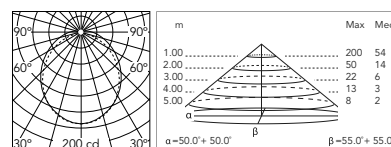

@ 4000K





* Nombre maximum de luminaires par source d'alimentation / Maximum number of luminaires per power supply.

Nombre maximum de luminaires par source d'alimentation (220-240 V). Ces données doivent être vérifiées en prenant en compte les conditions spécifiques d'installation.



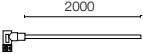

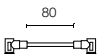

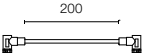



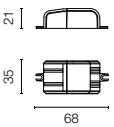

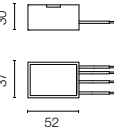

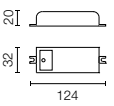

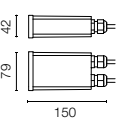
Maximum number of luminaires per power supply. (220-240 V). These data must be checked taking into account the specific installation conditions.

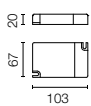
Acc. RF25750	1	Acc. F990B28A000	3
Acc. F990B21A000	1	Acc. F990B27A000	4
Acc. RF26387.A	1	Acc. F990B29A000	6
Acc. RF25752	1		

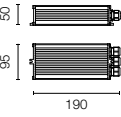
Tau: Accessoires / Accessories

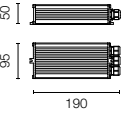
Câble d'alimentation de 2000 mm. Connecteur individuel.	Supply cable L.2000mm Single connector.	FA172	33,00 €		
Câble d'alimentation de 80mm Connecteur double.	Supply cable L.80mm Double connector.	FA173	27,00 €		
Câble d'alimentation de 200mm Connecteur double.	Supply cable L.200mm Double connector.	FA174	23,00 €		

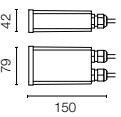
Tau: Appareillages électriques / Drivers

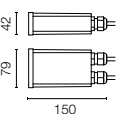
Source d'alimentation avec fonction dual Vout 24Vdc : 8W/100÷240V Iout 350ma: 6x1W/100÷240V IP20 Classe II Selv Eq.	Power supply dual function Vout 24Vdc: 8W/100÷240V Iout 350ma: 6x1W/100÷240V IP20 Class II Selv Eq.	Tau L 554 *RF25754	36,00 €		
Équipement d'alimentation 24V 8W / 110-240V IP65 Classe II selv.	Power supply 24V 8W / 110-240V IP65 Class II selv.	Tau L 554 *RF25748	63,00 €		
Équipement d'alimentation 24V 10W / 110-240V IP20 Classe II selv.	Power supply 24V 10W / 110-240V IP20 Class II selv.	Tau L 554 *RF25747	48,00 €		
Équipement d'alimentation 24V 10W / 110-240V IP67 Classe II selv.	Power supply 24V 10W / 110-240V IP67 Class II selv.	Tau L 554 *RF25757	86,00 €		
Équipement d'alimentation pour installation à distance 24Vdc 17W / 110-240V (15W@110V) IP20 Classe II selv.	Power supply for remote installation 24Vdc 17W / 110-240V (15W@110V) IP20 Class II selv.	*RF25750  Dimmable Push-Dim Or 1-10V See Wiring Diagram n.4. Page 830.	96,00 €		
Équipement d'alimentation 17W/110÷240V - 24Vdc (15W@110V) IP67 Classe II selv.	Power supply 17W/110÷240V - 24Vdc (15W@110V) IP67 Class II Selv.	*F990B21A000  Dimmable Push-Dim Or 1-10V See Wiring Diagram n.4. Page 830.	159,00 €		
Équipement d'alimentation pour installation à distance 24Vdc 20W / 110-240Vdc (15W@110V) IP67 Classe II selv.	Power supply for remote installation 24Vdc 20W / 110-240Vdc (15W@110V) IP67 Class II selv.	*RF26387.A  Dimmable DALI See Wiring Diagram n.4. Page 830.	159,00 €		
Équipement d'alimentation pour installation à distance 24Vdc 20W / 220-240V IP67 Classe II selv.	Power supply for remote installation 24Vdc 20W / 220-240V IP67 Class II selv.	*RF25752	133,00 €		
Alimentation 24Vdc 35W / 120-270V IP67 Classe II selv.	Power supply 24Vdc 35W / 120-270V IP67 Class II selv.	F990B23AZ00	180,00 €		

Tau: Appareillages électriques / Drivers

Équipement d'alimentation pour installation à distance 24Vdc 50W / 120-240V IP67 Classe II selv.	Power supply for remote installation 24Vdc 50W / 120-240V IP67 Class II selv.	*F990B28A000	251,00 €		
Équipement d'alimentation pour installation à distance 24Vdc 70W / 220-240V IP67 Classe II selv.	Power supply for remote installation 24Vdc 70W / 220-240V IP67 Class II selv.	*F990B27A000	212,00 €		
Équipement d'alimentation pour installation à distance 24Vdc 96W / 120-240V IP67 Classe II selv.	Power supply for remote installation 24Vdc 96W / 120-240V IP67 Class II selv.	*F990B29A000	300,00 €		

Exemple de configuration. / Example of configuration

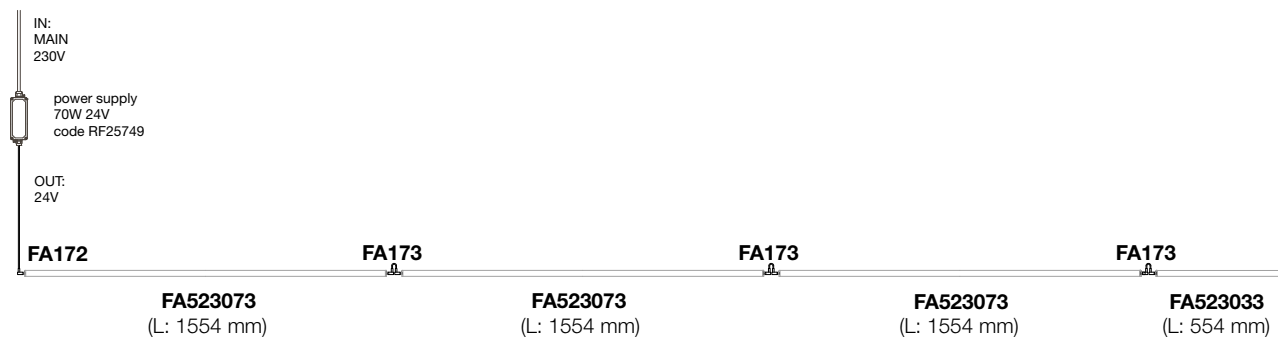

Longueur maximale en ligne continue de 5 m / Max length in continuous 5m

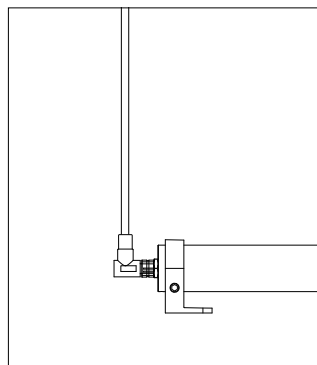

Acc. FA172

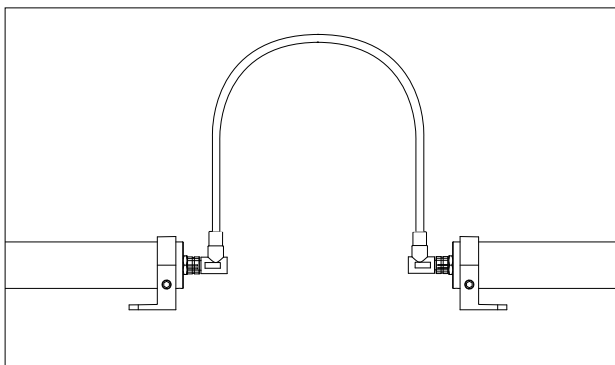

Acc. FA173

Eclipse



Eclipse





Famille / Family

Eclipse



Mid-Power Led

up to 10W
up to 387 lm - 2700K/CRI 80
up to 416 lm - 3000K/CRI 80
up to 437 lm - 4000K/CRI 80
* Net lumen output

Mid-Power Led

up to 7,5W
up to 387 lm - 2700K/CRI 80
up to 416 lm - 3000K/CRI 80
up to 437 lm - 4000K/CRI 80
* Net lumen output

Eclipse Mini



Low-Power Led

up to 1,8W
up to 45 lm - 2700K/CRI 80
up to 51 lm - 3000K/CRI 80
up to 55 lm - 4000K/CRI 80
* Net lumen output
[2200K available on request.](#)

Finitions / Colours



01 White



06 Grey



12 Forest Green



18 Deep Brown



30 Black



33 Anthracite

Description / Description

Famille de luminaires murales pour l'éclairage d'allées avec source LED. Les luminaires sont caractérisés par leur épaisseur réduite et leur forme ronde. Disponibles en deux tailles et en différentes finitions, avec un revêtement à poudre double couche et une surface traitée par procédé de conversion chimique pour garantir une haute résistance à la corrosion. Les vis de fixation sont en acier inoxydable AISI 316L.

Eclipse

Luminaire rond de grande taille pour installation au mur. Disponible en version avec source d'alimentation intégrée ou en version avec source d'alimentation à distance 24V dc, à commander séparément. Structure en aluminium moulé sous pression EN AB-47100 (à faible teneur en cuivre) et diffuseur en polycarbonate transparent ondulé. Complété par un câble en néoprène pour faciliter la connexion. Fixation directement sur la surface par une équerre en acier inoxydable incluse.

Eclipse Mini

Luminaire rond de petite taille pour installation au mur. Structure en aluminium moulé sous pression EN AB-47100 (à faible teneur en cuivre) et diffuseur en polycarbonate transparent ondulé. Complété par un câble en néoprène pour faciliter la connexion. Luminaire en 24V dc, nécessite une source d'alimentation à distance à commander séparément. Fixation directement sur la surface ou par une boîte encastrable à commander séparément, et qui est compatible avec la boîte de dérivation électrique avec 3 modules, modèle 503 et où la source d'alimentation à distance 24V dc peut être placée.

Family of wall mounted path lights with LED source. Defined by their reduced thickness and round shape. They're available in two dimensions and different finishes, with double-layered powder coating and chemical conversion surface treatment to ensure high corrosion resistance. The fixing screws are made of stainless steel AISI 316L.

Eclipse

Big round luminaire for wall mounting. Available with integrated power supply or remote 24V dc power supply that needs to be ordered separately. EN AB-47100 die cast aluminum body (with low copper content) and transparent profiled polycarbonate diffuser. It's completed with a neoprene cable section to ease the connection. Direct attachment on the surface with an included stainless steel bracket.

Eclipse Mini

Small round luminaire for wall mounting. EN AB-47100 die cast aluminum body (with low copper content) and transparent profiled polycarbonate diffuser. It's completed with a neoprene cable section to ease the connection. The 24V dc luminaire needs a remote power supply that needs to be ordered separately. Direct attachment on the surface or with a recessed box that needs to be ordered separately. Compatible with the three-module electrical junction box, model 503, where the remote 24V dc power supply can be installed.

Eclipse

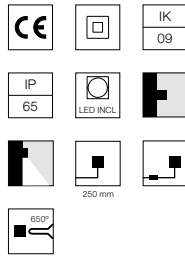
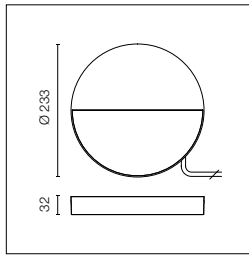

Eclipse 230V
Source LED incluse. Source d'alimentation électrique 220-240V ON/OFF. Équipé d'un câble sortant de 200 mm en néoprène, et d'un kit avec des connecteurs sertissables et des gaines thermorétractables adhésives qui garantissent l'étanchéité de la connexion.

Eclipse 230V
LED source included. Electrical power supply 220-240 ON/OFF. Equipped with a 200mm protruding section of neoprene cable and a kit with crimpable connectors and adhesive heat-shrinkable sleeves that guarantee the tightness of the connection.

Mid - Power Led: 10W - 739 lm ≠ OUTPUT 387 lm - 2700K/CRI 80 - 220±240V / 10W - 795 lm ≠ OUTPUT 416 lm - 3000K/CRI 80 - 220±240V / 10W - 835 lm ≠ OUTPUT 437 lm - 4000K/CRI 80 - 220±240V

2700K

○ FA54200701	272,00 €
● FA54200706	272,00 €
● FA54200712	272,00 €
● FA54200718	272,00 €
● FA54200730	272,00 €
● FA54200733	272,00 €

3000K

○ FA54200301	272,00 €
● FA54200306	272,00 €
● FA54200312	272,00 €
● FA54200318	272,00 €
● FA54200330	272,00 €
● FA54200333	272,00 €

4000K

○ FA54200201	272,00 €
● FA54200206	272,00 €
● FA54200212	272,00 €
● FA54200218	272,00 €
● FA54200230	272,00 €
● FA54200233	272,00 €

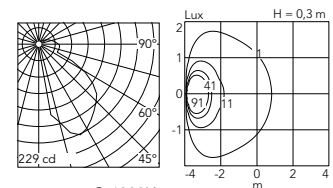

@ 4000K

Eclipse

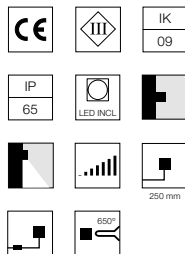
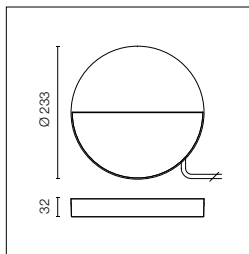

Source LED incluse. Source d'alimentation électrique à distance 24V dc, à commander séparément. Équipé d'un câble sortant de 300 mm en néoprène, et d'un kit avec des connecteurs sertissables et des gaines thermorétractables adhésives qui garantissent l'étanchéité de la connexion. Intensité réglable.

LED source included. Remote electrical power supply 24V dc to be ordered separately. Equipped with a 300mm protruding section of neoprene cable and a kit with crimpable connectors and adhesive heat-shrinkable sleeves that guarantee the tightness of the connection. Dimmable.

Mid - Power Led: 7,5W - 739 lm ≠ OUTPUT 387 lm - 2700K/CRI 80 - 24Vdc / 7,5W - 795 lm ≠ OUTPUT 416 lm - 3000K/CRI 80 - 24Vdc / 7,5W - 835 lm ≠ OUTPUT 437 lm - 4000K/CRI 80 - 24Vdc

2700K

○ FA54200901	260,00 €
● FA54200906	260,00 €
● FA54200912	260,00 €
● FA54200918	260,00 €
● FA54200930	260,00 €
● FA54200933	260,00 €

3000K

○ FA54200601	260,00 €
● FA54200606	260,00 €
● FA54200612	260,00 €
● FA54200618	260,00 €
● FA54200630	260,00 €
● FA54200633	260,00 €

4000K

○ FA54200501	260,00 €
● FA54200506	260,00 €
● FA54200512	260,00 €
● FA54200518	260,00 €
● FA54200530	260,00 €
● FA54200533	260,00 €

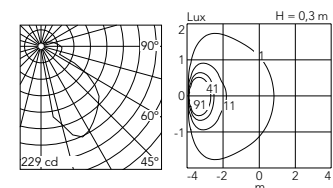

@ 4000K

* Nombre maximum de luminaires par source d'alimentation / Maximum number of luminaires per power supply.

Nombre maximum de luminaires par source d'alimentation (220±240 V). Ces données doivent être vérifiées en prenant en compte les conditions spécifiques d'installation.

Maximum number of luminaires per power supply. (220±240 V). These data must be checked taking into account the specific installation conditions.

Acc. RF25747	1	Acc. RF25752	2
Acc. RF25757	1	Acc. F990B28A000	6
Acc. RF25750	2	Acc. F990B27A000	9
Acc. F990B21A000	2	Acc. F990B29A000	12
Acc. RF26387.A	2		

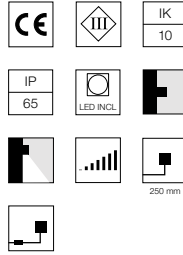
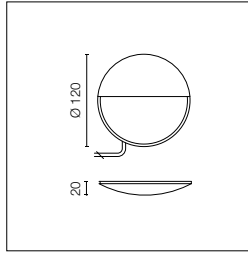

Source LED incluse. Le luminaire est complété par un écran réflecteur. Source d'alimentation électrique à distance 24v dc, à commander séparément. Boîte de dérivation optionnelle à commander séparément (boîte de dérivation avec 3 modules, modèle 503). Équipé d'un câble sortant de 250 mm en néoprène, et d'un kit avec des connecteurs sertissables et des gaines thermorétractables adhésives qui garantissent l'étanchéité de la connexion. Intensité réglable.

LED source included. Completed with a reflective screen. Remote electrical power supply 24V dc to be ordered separately. Optional electrical junction box (three modules, model 503) to be ordered separately. Equipped with a 250 mm protruding section of neoprene cable and a kit with crimpable connectors and adhesive heat-shrinkable sleeves that guarantee the tightness of the connection. Dimmable.

2200K disponible sur demande.

2200K available on request.

Low - Power Led: 1,8W - 187 lm ≠ OUTPUT 45 lm - 2700K/CRI 80 - 24Vdc / 1,8W - 212 lm ≠ OUTPUT 51 lm - 3000K/CRI 80 - 24Vdc / 1,8W - 227 lm ≠ OUTPUT 55 lm - 4000K/CRI 80 - 24Vdc

2700K

- FA52600501.A 154,00 €
- FA52600506.A 154,00 €
- FA52600512.A 154,00 €
- FA52600518.A 154,00 €
- FA52600530.A 154,00 €
- FA52600533.A 154,00 €

3000K

- FA52600301.A 154,00 €
- FA52600306.A 154,00 €
- FA52600312.A 154,00 €
- FA52600318.A 154,00 €
- FA52600330.A 154,00 €
- FA52600333.A 154,00 €

4000K

- FA52600201.A 154,00 €
- FA52600206.A 154,00 €
- FA52600212.A 154,00 €
- FA52600218.A 154,00 €
- FA52600230.A 154,00 €
- FA52600233.A 154,00 €

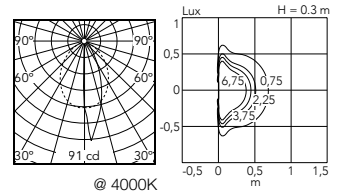

* Nombre maximum de luminaires par source d'alimentation / Maximum number of luminaires per power supply.

Nombre maximum de luminaires par source d'alimentation (220-240 V). Ces données doivent être vérifiées en prenant en compte les conditions spécifiques d'installation.

Maximum number of luminaires per power supply. (220-240 V). These data must be checked taking into account the specific installation conditions.

Acc. RF25754	3
Acc. RF25748	3
Acc. RF25747	5
Acc. RF25757	5
Acc. RF25750	8
Acc. F990B21A000	8

Acc. RF26387.A	9
Acc. RF25752	9
Acc. F990B28A000	25
Acc. F990B27A000	30
Acc. F990B29A000	45

Eclipse: Accessoires / Accessories

Dispositif de protection contre les surtensions. 275Vac. Courant de décharge maximal 10KA (8/20µs). Courant de fonctionnement maximal 5A. Adapté pour les connexions en séries. IP66.

Surge protection device. 275Vac. Maximum discharge current 10KA (8/20µs). Maximum operating current 5A. Suitable for series connection. IP66.

Eclipse
F990E00A000

116,00 €

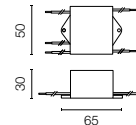

Boîtier de dérivation à encastrer 3 modules (modèle 503)

Recessed 3-module junction box (model 503)

Eclipse Mini
F990H010000

12,00 €

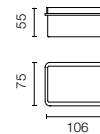

Recessed installation Eclipse Mini

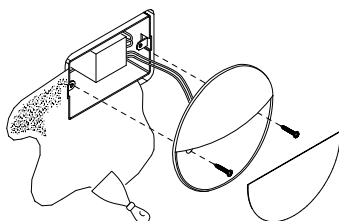

Wall installation Eclipse Mini

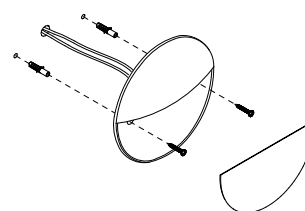

Eclipse: Appareillages électriques / Drivers

Équipement d'alimentation 24V 10W / 110-240V IP20 Classe II selv.	Power supply 24V 10W / 110-240V IP20 Class II selv.	*RF25747	48,00 €		
Équipement d'alimentation 24V 10W / 110-240V IP67 Classe II selv.	Power supply 24V 10W / 110-240V IP67 Class II selv.	*RF25757	86,00 €		
Équipement d'alimentation pour installation à distance 24Vdc 17W / 110-240V (15W@110V) IP20 Classe II selv.	Power supply for remote installation 24Vdc 17W / 110-240V (15W@110V) IP20 Class II selv.	*RF25750  Dimmable Push-Dim Or 1-10V See Wiring Diagram n.4. Page 830.	96,00 €		
Équipement d'alimentation 17W/110÷240V - 24Vdc (15W@110V) IP67 Classe II selv.	Power supply 17W/110÷240V - 24Vdc (15W@110V) IP67 Class II Selv.	*F990B21A000  Dimmable Push-Dim Or 1-10V See Wiring Diagram n.4. Page 830.	159,00 €		
Équipement d'alimentation pour installation à distance 24Vdc 20W / 110-240Vdc (15W@110V) IP67 Classe II selv.	Power supply for remote installation 24Vdc 20W / 110-240Vdc (15W@110V) IP67 Class II selv.	*RF26387.A  Dimmable DALI See Wiring Diagram n.4. Page 830.	159,00 €		
Équipement d'alimentation pour installation à distance 24Vdc 20W / 220-240V IP67 Classe II selv.	Power supply for remote installation 24Vdc 20W / 220-240V IP67 Class II selv.	*RF25752	133,00 €		
Alimentation 24Vdc 35W / 120-270V IP67 Classe II selv.	Power supply 24Vdc 35W / 120-270V IP67 Class II selv.	F990B23AZ00	180,00 €		
Équipement d'alimentation pour installation à distance 24Vdc 50W / 120-240V IP67 Classe II selv.	Power supply for remote installation 24Vdc 50W / 120-240V IP67 Class II selv.	*F990B28A000	251,00 €		
Équipement d'alimentation pour installation à distance 24Vdc 70W / 220-240V IP67 Classe II selv.	Power supply for remote installation 24Vdc 70W / 220-240V IP67 Class II selv.	*F990B27A000	212,00 €		
Équipement d'alimentation pour installation à distance 24Vdc 96W / 120-240V IP67 Classe II selv.	Power supply for remote installation 24Vdc 96W / 120-240V IP67 Class II selv.	*F990B29A000	300,00 €		
Source d'alimentation avec fonction dual Vout 24Vdc : 8W/100÷240V Iout 350ma: 6x1W/100÷240V IP20 Classe II Selv Eq.	Power supply dual function Vout 24Vdc: 8W/100÷240V Iout 350ma: 6x1W/100÷240V IP20 Class II Selv Eq.	Eclipse Mini *RF25754	36,00 €		
Équipement d'alimentation 24V 8W / 110-240V IP65 Classe II selv.	Power supply 24V 8W / 110-240V IP65 Class II selv.	Eclipse Mini *RF25748	63,00 €		

Hyperion





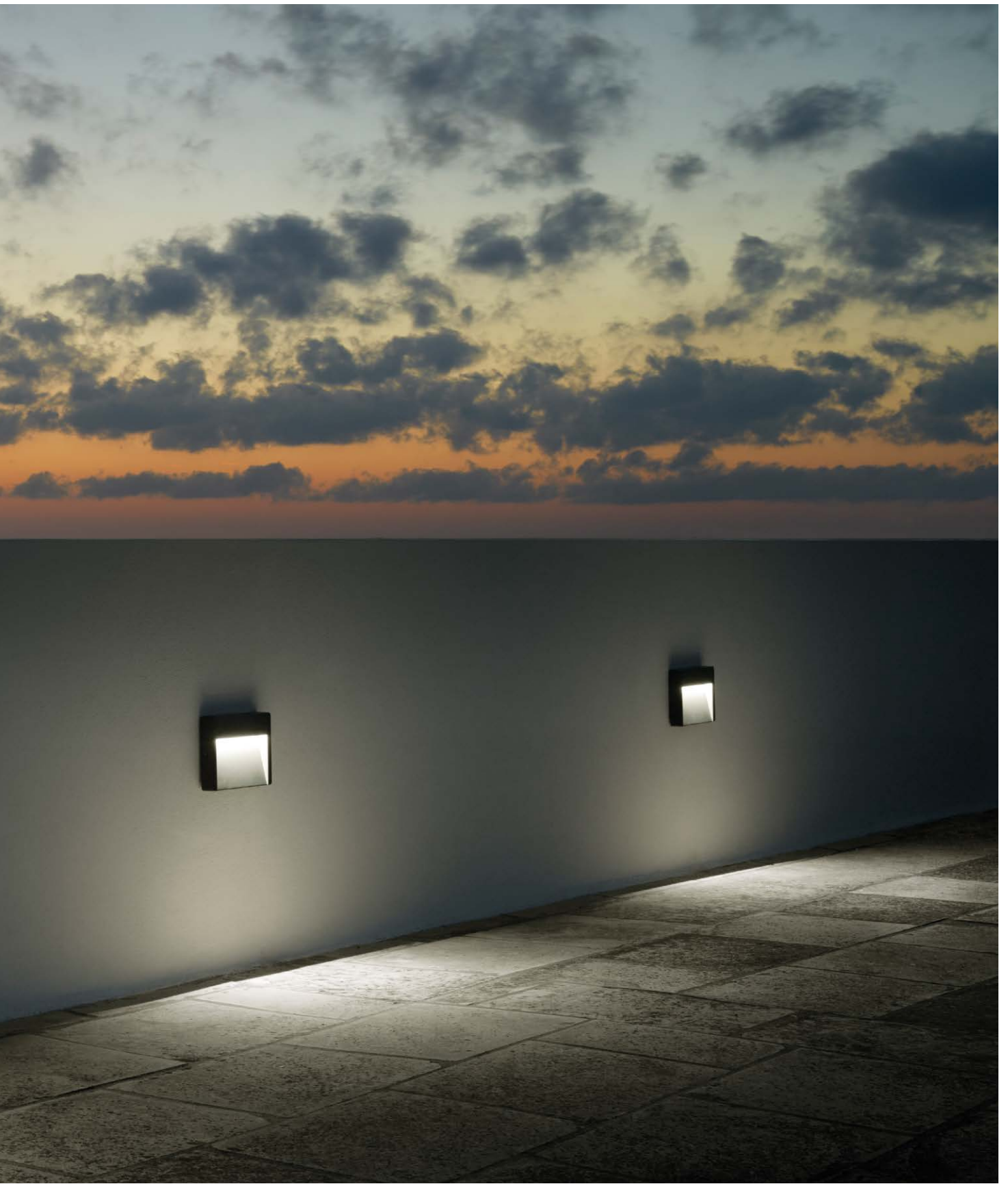

Famille / Family

Hyperion



Mid-Power Led

up to 10W
up to 401 lm - 2700K/CRI 80
up to 428 lm - 3000K/CRI 80
up to 442 lm - 4000K/CRI 80
* Net lumen output

Mid-Power Led

up to 7,5W
up to 370 lm - 2700K/CRI 80
up to 398 lm - 3000K/CRI 80
up to 418 lm - 4000K/CRI 80
* Net lumen output

Hyperion Mini



Low-Power Led

up to 1,9W
up to 57 lm - 2700K/CRI 80
up to 61 lm - 3000K/CRI 80
up to 64 lm - 4000K/CRI 80
* Net lumen output

Finitions / Colours



01 White

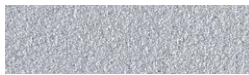

06 Grey



12 Forest Green



18 Deep Brown



30 Black



33 Anthracite

Description / Description

Famille de luminaires murales pour l'éclairage d'allées avec source LED. Les luminaires sont caractérisés par leur épaisseur réduite et leur forme rectangulaire. Disponibles en deux tailles et en différentes finitions avec un revêtement à poudre double couche et une surface traitée par procédé de conversion chimique pour garantir une haute résistance à la corrosion. Les vis de fixation sont en acier inoxydable AISI 316L.

Hyperion

Luminaire rectangulaire de grande taille et épaisseur réduite pour installation au mur. Disponible en version avec source d'alimentation incorporée ou en version avec source d'alimentation à distance pour 24V dc, à commander séparément. Structure en aluminium moulé sous pression EN AB-47100 (à faible teneur en cuivre) et diffuseur en polycarbonate transparent moulé. Équipé d'un câble en néoprène pour faciliter la connexion. Fixation directement sur la surface par une équerre en acier inoxydable incluse. Accessoires optionnels disponibles : réflecteur et poteau. Le réflecteur en aluminium satiné augmente le flux lumineux approximativement un 20% et il est fixé à la structure par l'adhésif double face fourni. Le poteau extrudé est utilisé pour installer le luminaire en tant que borne. Le poteau peut s'installer facilement sur tout type de surface au sol à l'aide de chevilles ou en utilisant la plaque d'ancrage spécifique (accessoire) ainsi que les tire-fonds qui fixent le luminaire au sol solidement.

Hyperion Mini

Luminaire rectangulaire de petite taille pour installation au mur. Structure en aluminium moulé sous pression EN AB-47100 (à faible teneur en cuivre) et diffuseur en polycarbonate transparent moulé. Écran réflecteur en aluminium satiné à appliquer avec l'adhésif double face fourni. Équipé d'un câble en néoprène pour faciliter la connexion. Luminaire en 24V dc, nécessite une source d'alimentation à distance à commander séparément. Fixation directement sur la surface ou par une boîte encastrable à commander séparément, qui est compatible avec la boîte de dérivation électrique avec 3 modules, modèle 503 et où la source d'alimentation à distance 24V dc peut être placée.

Family of wall mounted path lights with LED source. Defined by their reduced thickness and rectangular shape. They're available in two dimensions and different finishes, with double-layered powder coating and chemical conversion surface treatment to ensure high corrosion resistance. The fixing screws are made of stainless steel AISI 316L.

Hyperion

Big rectangular luminaire with reduced thickness for wall mounting. Available with integrated power supply or remote 24V dc power supply that needs to be ordered separately. EN AB-47100 die cast aluminum body (with low copper content) and transparent molded polycarbonate diffuser. It's completed with a neoprene cable section to ease the connection. Direct attachment on the surface with an included stainless steel bracket. Optional accessories available: reflector and post. The satin aluminum reflector increases the luminous flux by approximately 20% and is attached to the body with the double-sided adhesive provided. The extruded post is used to install the luminaire as a bollard. The post is easily installed on any floor surface by means of dowels or the specific accessory anchor plate and lag screws that secure the luminaire solidly to the pavement.

Hyperion Mini

Small rectangular luminaire for wall mounting. EN AB-47100 die cast aluminum body (with low copper content) and transparent molded polycarbonate diffuser. Reflective satin aluminum screen that is attached with the double-sided adhesive provided. With a neoprene cable section to ease the connection. The 24V luminaire needs a remote power supply that needs to be ordered separately. Direct attachment on the surface or with a recessed box that needs to be ordered separately. Compatible with the three module electrical junction box, model 503, where the remote 24V dc power supply can be installed.

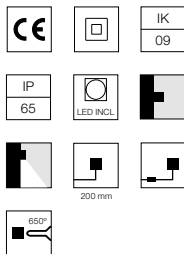
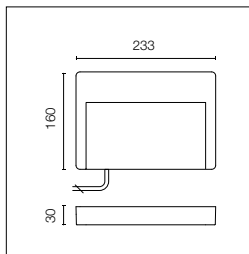

Hyperion 230V.
Source LED incluse. Source d'alimentation électrique 220-240V ON/OFF. Équipé d'un câble sortant de 200 mm en néoprène, et d'un kit avec des connecteurs sertissables et des gaines thermorétractables adhésives qui garantissent l'étanchéité de la connexion. Accessoires optionnels : réflecteur en aluminium satiné pour augmenter le flux lumineux : borne extrudée de 500 mm de haut pour la version borne. Plaque d'ancrage pour encastrement avec mortier, à commander séparément.

Hyperion 230V.
LED source included. Electrical power supply 220-240V ON/OFF. Equipped with a 200 mm protruding section of neoprene cable and a kit with crimpable connectors and adhesive heat-shrinkable sleeves that guarantee the tightness of the connection. Optional accessories: satin aluminum reflector to increase the luminous flux; 500mm tall, extruded post for the bollard version. Anchor plate to be recessed with mortar needs to be ordered separately.

Mid - Power Led: 10W - 739 lm ≠ OUTPUT 401 lm - 2700K/CRI 80 - 220÷240V / 10W - 795 lm ≠ OUTPUT 428 lm - 3000K/CRI 80 - 220÷240V / 10W - 835 lm ≠ OUTPUT 442 lm - 4000K/CRI 80 - 220÷240V

2700K

- FA52700501
- FA52700506
- FA52700512
- FA52700518
- FA52700530
- FA52700533

- 273,00 €
- 273,00 €
- 273,00 €
- 273,00 €
- 273,00 €
- 273,00 €

3000K

- FA52700301
- FA52700306
- FA52700312
- FA52700318
- FA52700330
- FA52700333

- 273,00 €
- 273,00 €
- 273,00 €
- 273,00 €
- 273,00 €
- 273,00 €

4000K

- FA52700201
- FA52700206
- FA52700212
- FA52700218
- FA52700230
- FA52700233

- 273,00 €
- 273,00 €
- 273,00 €
- 273,00 €
- 273,00 €
- 273,00 €

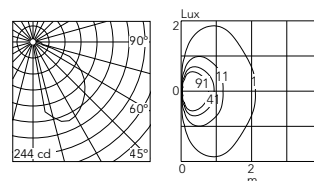

@ 4000K

Hyperion

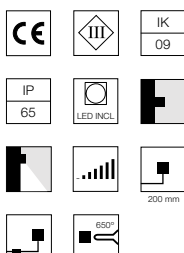
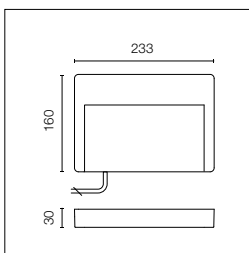

Source LED incluse. Source d'alimentation électrique 24v à distance, à commander séparément. Équipé d'un câble sortant de 300 mm en néoprène, et d'un kit avec des connecteurs sertissables et des gaines thermorétractables adhésives qui garantissent l'étanchéité de la connexion. Accessoires optionnels : réflecteur en aluminium satiné pour augmenter le flux lumineux : borne extrudée de 500 mm de haut pour la version borne. Plaque d'ancrage pour encastrement avec mortier, à commander séparément. Intensité réglable.

LED source included. Remote electrical power supply 24V dc to be ordered separately. Equipped with a 300 mm protruding section of neoprene cable and a kit with crimpable connectors and adhesive heat-shrinkable sleeves that guarantee the tightness of the connection. Optional accessories: satin aluminum reflector to increase the luminous flux; 500mm tall, extruded post for the bollard version. Anchor plate to be recessed with mortar needs to be ordered separately. Dimmable.

Mid - Power Led: 7,5W - 739 lm ≠ OUTPUT 401 lm - 2700K/CRI 80 - 24Vdc / 7,5W - 795 lm ≠ OUTPUT 428 lm - 3000K/CRI 80 - 24Vdc / 7,5W - 835 lm ≠ OUTPUT 442 lm - 4000K/CRI 80 - 24Vdc

2700K

- FA52701501
- FA52701506
- FA52701512
- FA52701518
- FA52701530
- FA52701533

- 261,00 €
- 261,00 €
- 261,00 €
- 261,00 €
- 261,00 €
- 261,00 €

3000K

- FA52701301
- FA52701306
- FA52701312
- FA52701318
- FA52701330
- FA52701333

- 261,00 €
- 261,00 €
- 261,00 €
- 261,00 €
- 261,00 €
- 261,00 €

4000K

- FA52701201
- FA52701206
- FA52701212
- FA52701218
- FA52701230
- FA52701233

- 261,00 €
- 261,00 €
- 261,00 €
- 261,00 €
- 261,00 €
- 261,00 €

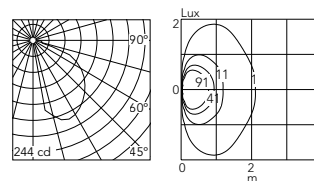

@ 4000K

* Nombre maximum de luminaires par source d'alimentation / Maximum number of luminaires per power supply.

Nombre maximum de luminaires par source d'alimentation (220÷240 V). Ces données doivent être vérifiées en prenant en compte les conditions spécifiques d'installation.

Maximum number of luminaires per power supply. (220÷240 V). These data must be checked taking into account the specific installation conditions.

Acc. RF25747	1
Acc. RF25757	1
Acc. RF25750	2
Acc. F990B21A000	2
Acc. RF26387.A	2

Acc. RF25752	2
Acc. F990B28A000	6
Acc. F990B27A000	9
Acc. F990B29A000	12

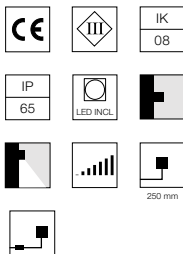
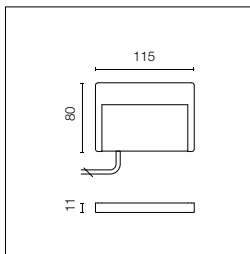

Source LED incluse. Le luminaire est complété par un écran réflecteur. Source d'alimentation électrique à distance 24v dc, à commander séparément. Boîte de dérivation optionnelle à commander séparément (boîte de dérivation avec 3 modules, modèle 503). Équipé d'un câble sortant de 250 mm en néoprène, et d'un kit avec des connecteurs sertissables et des gaines thermorétractables adhésives qui garantissent l'étanchéité de la connexion. Intensité réglable.

LED source included. Completed with a reflective screen. Remote electrical power supply 24V dc to be ordered separately. Optional junction box to be ordered separately (3 module electrical box, model 503). Equipped with a 250 mm protruding section of neoprene cable and a kit with crimpable connectors and adhesive heat-shrinkable sleeves that guarantee the tightness of the connection. Dimmable.

Low - Power Led: 1,9W - 139 lm ≠ OUTPUT 57 lm - 2700K/CRI 80 - 24Vdc / 1,9W - 149 lm ≠ OUTPUT 61 lm - 3000K/CRI 80 - 24Vdc / 1,9W - 156 lm ≠ OUTPUT 64 lm - 4000K/CRI 80 - 24Vdc

2700K		3000K		4000K	
○ FA102960001	154,00 €	○ FA102950001	154,00 €	○ FA1022290001	154,00 €
● FA102960006	154,00 €	● FA102950006	154,00 €	● FA1022290006	154,00 €
● FA102960012	154,00 €	● FA102950012	154,00 €	● FA1022290012	154,00 €
● FA102960018	154,00 €	● FA102950018	154,00 €	● FA1022290018	154,00 €
● FA102960030	154,00 €	● FA102950030	154,00 €	● FA1022290030	154,00 €
● FA102960033	154,00 €	● FA102950033	154,00 €	● FA1022290033	154,00 €

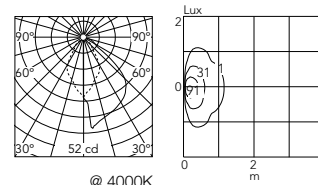

* Nombre maximum de luminaires par source d'alimentation / Maximum number of luminaires per power supply.

Nombre maximum de luminaires par source d'alimentation (220-240 V). Ces données doivent être vérifiées en prenant en compte les conditions spécifiques d'installation.

Maximum number of luminaires per power supply. (220-240 V). These data must be checked taking into account the specific installation conditions.

Acc. RF25754	3	Acc. RF26387_A	9
Acc. RF25748	3	Acc. RF25752	9
Acc. RF25747	5	Acc. F990B28A000	25
Acc. RF25757	5	Acc. F990B27A000	30
Acc. RF25750	8	Acc. F990B29A000	45
Acc. F990B21A000	8		

Hyperion: Accessoires / Accessories

Dispositif de protection contre les surtensions. 275Vac. Courant de décharge maximal 10KA (8/20µs). Courant de fonctionnement maximal 5A. Adapté pour les connexions en séries. IP66.

Surge protection device. 275Vac. Maximum discharge current 10KA (8/20µs). Maximum operating current 5A. Suitable for series connection. IP66.

Hyperion
F990E00A000

116,00 €

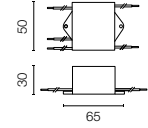

Carter en aluminium satiné épaisseur 0,5 mm

Satin aluminium carter Thickness 0.5mm.

Hyperion
FA160

26,00 €



+



Lamp.4

=



Lamp.4+cod.160 =+20% lm

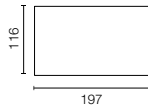

Utilisation du support en tant que borne. Fixation directe à l'aide de chevilles ou avec une plaque base d'ancrage et des tire-fonds (accessoire optionnel).

Use of the extruded support as bollard. Direct fixing using studs or a base plate and fixing bolts (optional accessory).

H 500 mm

- FA24501
- FA24506
- FA24512
- FA24518
- FA24530
- FA24533

179,00 €

179,00 €

179,00 €

179,00 €

179,00 €

179,00 €

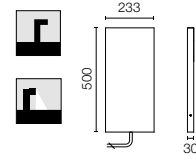

Plaque de boulons.

Base plate with bolt.

Hyperion
FA247

65,00 €

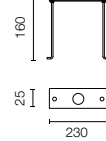

Boitier de dérivation à encastrer 3 modules (modèle 503)

Recessed 3-module junction box (model 503)

Hyperion Mini
F990H010000

12,00 €

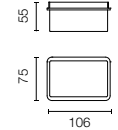



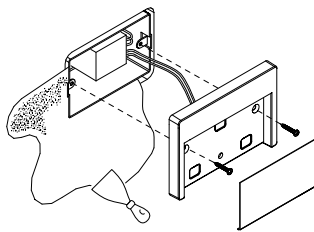



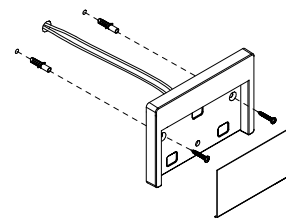



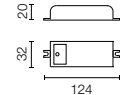

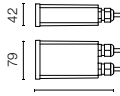

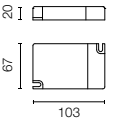

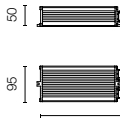

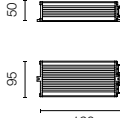

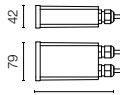
Recessed installation

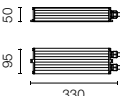

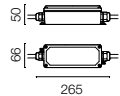
Wall installation

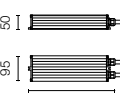

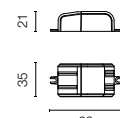
Hyperion: Appareillages électriques / Drivers

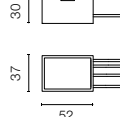
Équipement d'alimentation 24V 10W / 110-240V IP20 Classe II selv.	Power supply 24V 10W / 110-240V IP20 Class II selv.	*RF25747	48,00 €		
Équipement d'alimentation 24V 10W / 110-240V IP67 Classe II selv.	Power supply 24V 10W / 110-240V IP67 Class II selv.	*RF25757	86,00 €		
Équipement d'alimentation pour installation à distance 24Vdc 17W / 110-240V (15W@110V) IP20 Classe II selv.	Power supply for remote installation 24Vdc 17W / 110-240V (15W@110V) IP20 Class II selv.	*RF25750  Dimmable Push-Dim Or 1-10V See Wiring Diagram n.4. Page 830.	96,00 €		
Équipement d'alimentation 17W/110÷240V - 24Vdc (15W@110V) IP67 Classe II selv.	Power supply 17W/110÷240V - 24Vdc (15W@110V) IP67 Class II Selv.	*F990B21A000  Dimmable Push-Dim Or 1-10V See Wiring Diagram n.4. Page 830.	159,00 €		
Équipement d'alimentation pour installation à distance 24Vdc 20W / 110-240Vdc (15W@110V) IP67 Classe II selv.	Power supply for remote installation 24Vdc 20W / 110-240Vdc (15W@110V) IP67 Class II selv.	*RF26387.A  Dimmable DALI See Wiring Diagram n.4. Page 830.	159,00 €		
Équipement d'alimentation pour installation à distance 24Vdc 20W / 220-240V IP67 Classe II selv.	Power supply for remote installation 24Vdc 20W / 220-240V IP67 Class II selv.	*RF25752	133,00 €		
Équipement d'alimentation pour installation à distance 24Vdc 50W / 120-240V IP67 Classe II selv.	Power supply for remote installation 24Vdc 50W / 120-240V IP67 Class II selv.	*F990B28A000	251,00 €		
Équipement d'alimentation pour installation à distance 24Vdc 70W / 220-240V IP67 Classe II selv.	Power supply for remote installation 24Vdc 70W / 220-240V IP67 Class II selv.	*F990B27A000	212,00 €		
Équipement d'alimentation pour installation à distance 24Vdc 96W / 120-240V IP67 Classe II selv.	Power supply for remote installation 24Vdc 96W / 120-240V IP67 Class II selv.	*F990B29A000	300,00 €		
Source d'alimentation avec fonction dual Vout 24Vdc : 8W/100÷240V lout 350ma: 6x1W/100÷240V IP20 Classe II Selv Eq.	Power supply dual function Vout 24Vdc: 8W/100÷240V lout 350ma: 6x1W/100÷240V IP20 Class II Selv Eq.	Hyperion Mini *RF25754	36,00 €		
Équipement d'alimentation 24V 8W / 110-240V IP65 Classe II selv.	Power supply 24V 8W / 110-240V IP65 Class II selv.	Hyperion Mini *RF25748	63,00 €		

Platter

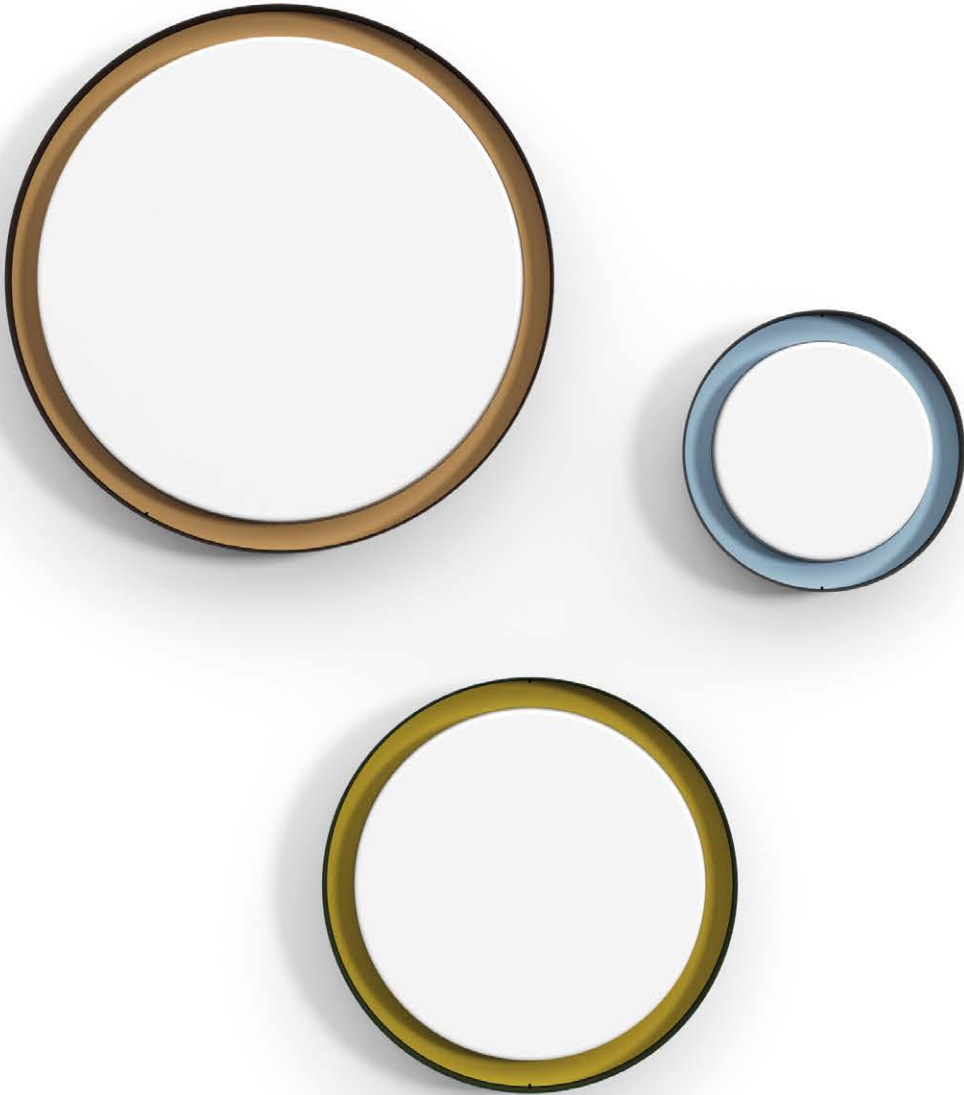

Platter





Famille / Family

Platter 410



Mid-Power Led

up to 34W
up to 2345 lm - 2700K/CRI 80
up to 2521 lm - 3000K/CRI 80
up to 2712 lm - 4000K/CRI 80
* Net lumen output

Platter 310



Mid-Power Led

up to 18W
up to 1150 lm - 2700K/CRI 80
up to 1237 lm - 3000K/CRI 80
up to 1330 lm - 4000K/CRI 80
* Net lumen output

Platter 210



Mid-Power Led

up to 11W
up to 732 lm - 2700K/CRI 80
up to 787 lm - 3000K/CRI 80
up to 812 lm - 4000K/CRI 80
* Net lumen output

Finitions / Colours

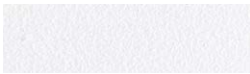

01 White



06 Grey

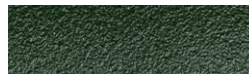

12 Forest Green



18 Deep Brown



30 Black



33 Anthracite



Grey / Brown Brick



Anthracite / Pale Blue



Deep Brown / Pale Brown



Forest Green / Olive Green

Description / Description

Famille de luminaires pour installation au mur ou au plafond. Les luminaires sont caractérisés par leur forme ronde. Ils sont disponibles en trois tailles. Diffuseur en plastique opale qui garantit une haute uniformité de l'émission lumineuse. Plaque de fixation en aluminium moulé sous pression EN AB-47100 (à faible teneur en cuivre), structure et dissipateurs de chaleur en aluminium usiné par tournage. Cadre de fermeture magnétique pour cacher les vis de fixation, en acier inoxydable AISI316L. Disponibles en différentes finitions avec un revêtement à poudre double couche et une surface traitée par procédé de conversion chimique pour garantir une haute résistance à la corrosion.

Family of wall or ceiling mounted luminaires. Defined by their round shape. Available in three dimensions. Diffuser made of opal plastic material that guarantees high uniformity in light emission. EN AB-47100 die-cast mounting plate (with low copper content), turned aluminum structure and heat sinks. Magnetic closing frame to hide the AISI 316L stainless steel fixing screws. Available in different finishes, with double-layered powder coating and chemical conversion surface treatment to ensure high corrosion resistance.

Platter 410

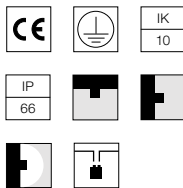
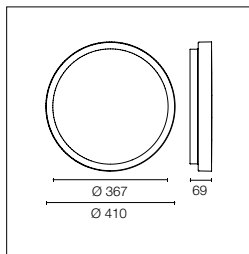

Source LED incluse. Source d'alimentation électrique intégrée 220-240V ON/OFF et intensité réglable entre 1 et 10V ou DALI. Équipé d'une gaine IP65 pour des câbles en caoutchouc de 5mmϕ<math><10\text{mm}</math> et d'une boîte de dérivation à 2 pôles pour des connexions rapides. Pour garantir l'étanchéité de la gaine il est conseillé d'utiliser des câbles électriques flexibles et conçus pour l'extérieur.

LED source included. Integrated power supply 220-240V ON/OFF and dimmable 1-10V or DALI. With IP65 cable guide for rubber cables 5mmϕ<math><10\text{mm}</math> and a 2-pole connection box for a fast connection. To ensure the tightness of the cable guide it's recommended to use flexible electric cables suitable for exterior use.

Mid-Power Led: 34W - 3590 lm \neq OUTPUT 2345 lm - 2700K/CRI 80 - 220÷240V / 34W - 3860 lm \neq OUTPUT 2521 lm - 3000K/CRI 80 - 220÷240V / 34W - 4152 lm \neq OUTPUT 2712 lm - 4000K/CRI 80 - 220÷240V

2700K

Non Dimmable

- FA53305201 580,00 €
- FA53305206 580,00 €
- FA53305212 580,00 €
- FA53305218 580,00 €
- FA53305230 580,00 €
- FA53305233 580,00 €

1-10V

- FA53305201-310 631,00 €
- FA53305206-310 631,00 €
- FA53305212-310 631,00 €
- FA53305218-310 631,00 €
- FA53305230-310 631,00 €
- FA53305233-310 631,00 €

Dali

- FA53305201-300 695,00 €
- FA53305206-300 695,00 €
- FA53305212-300 695,00 €
- FA53305218-300 695,00 €
- FA53305230-300 695,00 €
- FA53305233-300 695,00 €

3000K

Non Dimmable

- FA53302201 580,00 €
- FA53302206 580,00 €
- FA53302212 580,00 €
- FA53302218 580,00 €
- FA53302230 580,00 €
- FA53302233 580,00 €

1-10V

- FA53302201-310 631,00 €
- FA53302206-310 631,00 €
- FA53302212-310 631,00 €
- FA53302218-310 631,00 €
- FA53302230-310 631,00 €
- FA53302233-310 631,00 €

Dali

- FA53302201-300 695,00 €
- FA53302206-300 695,00 €
- FA53302212-300 695,00 €
- FA53302218-300 695,00 €
- FA53302230-300 695,00 €
- FA53302233-300 695,00 €

4000K

Non Dimmable

- FA53302101 580,00 €
- FA53302106 580,00 €
- FA53302112 580,00 €
- FA53302118 580,00 €
- FA53302130 580,00 €
- FA53302133 580,00 €

1-10V

- FA53302101-310 631,00 €
- FA53302106-310 631,00 €
- FA53302112-310 631,00 €
- FA53302118-310 631,00 €
- FA53302130-310 631,00 €
- FA53302133-310 631,00 €

Dali

- FA53302101-300 695,00 €
- FA53302106-300 695,00 €
- FA53302112-300 695,00 €
- FA53302118-300 695,00 €
- FA53302130-300 695,00 €
- FA53302133-300 695,00 €

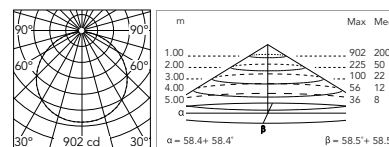

@ 4000K

Platter 410 Grey / Brown Brick

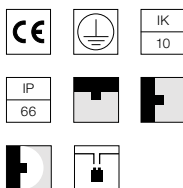
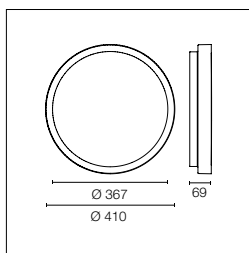

Source LED incluse. Source d'alimentation électrique intégrée 220-240V ON/OFF et intensité réglable entre 1 et 10V ou DALI. Équipé d'une gaine IP65 pour des câbles en caoutchouc de 5mmϕ<math><10\text{mm}</math> et d'une boîte de dérivation à 2 pôles pour des connexions rapides. Pour garantir l'étanchéité de la gaine il est conseillé d'utiliser des câbles électriques flexibles et conçus pour l'extérieur.

LED source included. Integrated power supply 220-240V ON/OFF and dimmable 1-10V or DALI. With IP65 cable guide for rubber cables 5mmϕ<math><10\text{mm}</math> and a 2-pole connection box for a fast connection. To ensure the tightness of the cable guide it's recommended to use flexible electric cables suitable for exterior use.

Mid-Power Led: 34W - 3590 lm \neq OUTPUT 2345 lm - 2700K/CRI 80 - 220÷240V / 34W - 3860 lm \neq OUTPUT 2521 lm - 3000K/CRI 80 - 220÷240V / 34W - 4152 lm \neq OUTPUT 2712 lm - 4000K/CRI 80 - 220÷240V

2700K

Non Dimmable

- FA533421 638,00 €
- FA533421-310 690,00 €
- FA533421-300 755,00 €

1-10V

Dali

3000K

Non Dimmable

- FA533431 638,00 €
- FA533431-310 690,00 €
- FA533431-300 755,00 €

1-10V

Dali

4000K

Non Dimmable

- FA533441 638,00 €
- FA533441-310 690,00 €
- FA533441-300 755,00 €

1-10V

Dali

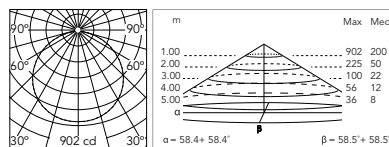

@ 4000K

Platter 410 Anthracite / Pale Blue

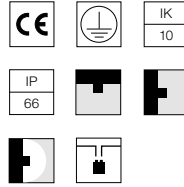
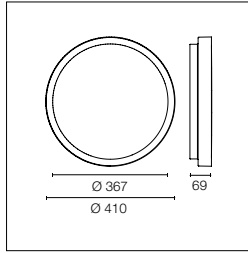

Source LED incluse. Source d'alimentation électrique intégrée 220-240V ON/OFF et intensité réglable entre 1 et 10V ou DALI. Équipé d'une gaine IP65 pour des câbles en caoutchouc de 5mmϕ<math><10\text{mm}</math> et d'une boîte de dérivation à 2 pôles pour des connexions rapides. Pour garantir l'étanchéité de la gaine il est conseillé d'utiliser des câbles électriques flexibles et conçus pour l'extérieur.

LED source included. Integrated power supply 220-240V ON/OFF and dimmable 1-10V or DALI. With IP65 cable guide for rubber cables 5mmϕ<math><10\text{mm}</math> and a 2-pole connection box for a fast connection. To ensure the tightness of the cable guide it's recommended to use flexible electric cables suitable for exterior use.

Mid-Power Led: 34W - 3590 lm \neq OUTPUT 2345 lm - 2700K/CRI 80 - 220 \pm 240V / 34W - 3860 lm \neq OUTPUT 2521 lm - 3000K/CRI 80 - 220 \pm 240V / 34W - 4152 lm \neq OUTPUT 2712 lm - 4000K/CRI 80 - 220 \pm 240V

2700K

Non Dimmable

- FA533422 638,00 €
- FA533422-310 690,00 €
- FA533422-300 755,00 €

3000K

Non Dimmable

- FA533432 638,00 €
- FA533432-310 690,00 €
- FA533432-300 755,00 €

4000K

Non Dimmable

- FA533442 638,00 €
- FA533442-310 690,00 €
- FA533442-300 755,00 €

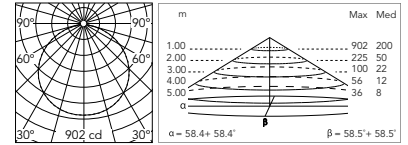

@ 4000K

Platter 410 Deep Brown / Pale Brown

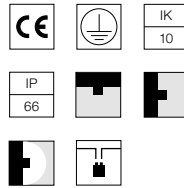
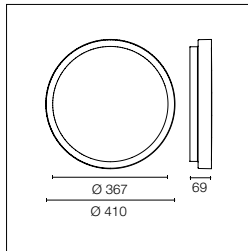

Source LED incluse. Source d'alimentation électrique intégrée 220-240V ON/OFF et intensité réglable entre 1 et 10V ou DALI. Équipé d'une gaine IP65 pour des câbles en caoutchouc de 5mmϕ<math><10\text{mm}</math> et d'une boîte de dérivation à 2 pôles pour des connexions rapides. Pour garantir l'étanchéité de la gaine il est conseillé d'utiliser des câbles électriques flexibles et conçus pour l'extérieur.

LED source included. Integrated power supply 220-240V ON/OFF and dimmable 1-10V or DALI. With IP65 cable guide for rubber cables 5mmϕ<math><10\text{mm}</math> and a 2-pole connection box for a fast connection. To ensure the tightness of the cable guide it's recommended to use flexible electric cables suitable for exterior use.

Mid-Power Led: 34W - 3590 lm \neq OUTPUT 2345 lm - 2700K/CRI 80 - 220 \pm 240V / 34W - 3860 lm \neq OUTPUT 2521 lm - 3000K/CRI 80 - 220 \pm 240V / 34W - 4152 lm \neq OUTPUT 2712 lm - 4000K/CRI 80 - 220 \pm 240V

2700K

Non Dimmable

- FA533423 638,00 €
- FA533423-310 690,00 €
- FA533423-300 755,00 €

3000K

Non Dimmable

- FA533433 638,00 €
- FA533433-310 690,00 €
- FA533433-300 755,00 €

4000K

Non Dimmable

- FA533443 638,00 €
- FA533443-310 690,00 €
- FA533443-300 755,00 €

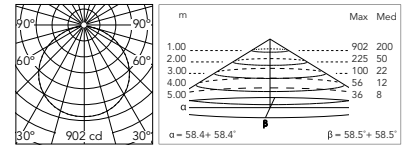

@ 4000K

Platter 410 Forest Green / Olive Green

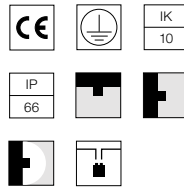
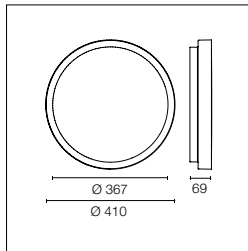

Source LED incluse. Source d'alimentation électrique intégrée 220-240V ON/OFF et intensité réglable entre 1 et 10V ou DALI. Équipé d'une gaine IP65 pour des câbles en caoutchouc de 5mmϕ<math><10\text{mm}</math> et d'une boîte de dérivation à 2 pôles pour des connexions rapides. Pour garantir l'étanchéité de la gaine il est conseillé d'utiliser des câbles électriques flexibles et conçus pour l'extérieur.

LED source included. Integrated power supply 220-240V ON/OFF and dimmable 1-10V or DALI. With IP65 cable guide for rubber cables 5mmϕ<math><10\text{mm}</math> and a 2-pole connection box for a fast connection. To ensure the tightness of the cable guide it's recommended to use flexible electric cables suitable for exterior use.

Mid-Power Led: 34W - 3590 lm \neq OUTPUT 2345 lm - 2700K/CRI 80 - 220 \pm 240V / 34W - 3860 lm \neq OUTPUT 2521 lm - 3000K/CRI 80 - 220 \pm 240V / 34W - 4152 lm \neq OUTPUT 2712 lm - 4000K/CRI 80 - 220 \pm 240V

2700K

Non Dimmable

- FA533424 638,00 €
- FA533424-310 690,00 €
- FA533424-300 755,00 €

3000K

Non Dimmable

- FA533434 638,00 €
- FA533434-310 690,00 €
- FA533434-300 755,00 €

4000K

Non Dimmable

- FA533444 638,00 €
- FA533444-310 690,00 €
- FA533444-300 755,00 €

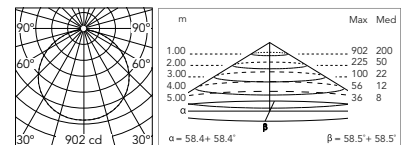

@ 4000K

Platter 310

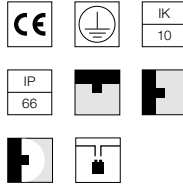
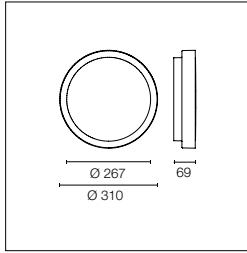

Source LED incluse. Source d'alimentation électrique intégrée 220-240V ON/OFF et intensité réglable entre 1 et 10V ou DALI. Équipé d'une gaine IP65 pour des câbles en caoutchouc de 5mmϕ<math><10\text{mm}</math> et d'une boîte de dérivation à 2 pôles pour des connexions rapides. Pour garantir l'étanchéité de la gaine il est conseillé d'utiliser des câbles électriques flexibles et conçus pour l'extérieur.

LED source included. Integrated power supply 220-240V ON/OFF and dimmable 1-10V or DALI. With IP65 cable guide for rubber cables 5mmϕ<math><10\text{mm}</math> and a 2-pole connection box for a fast connection. To ensure the tightness of the cable guide it's recommended to use flexible electric cables suitable for exterior use.

Mid-Power Led: 18W - 1874 lm \neq OUTPUT 1150 lm - 2700K/CRI 80 - 220 \div 240V / 18W - 2015 lm \neq OUTPUT 1237 lm - 3000K/CRI 80 - 220 \div 240V / 18W - 2168 lm \neq OUTPUT 1330 lm - 4000K/CRI 80 - 220 \div 240V

2700K		3000K		4000K	
Non Dimmable		Non Dimmable		Non Dimmable	
○ FA53305101	292,00 €	○ FA53301201	292,00 €	○ FA53301101	292,00 €
● FA53305106	292,00 €	● FA53301206	292,00 €	● FA53301106	292,00 €
● FA53305112	292,00 €	● FA53301212	292,00 €	● FA53301112	292,00 €
● FA53305118	292,00 €	● FA53301218	292,00 €	● FA53301118	292,00 €
● FA53305130	292,00 €	● FA53301230	292,00 €	● FA53301130	292,00 €
● FA53305133	292,00 €	● FA53301233	292,00 €	● FA53301133	292,00 €
1-10V		1-10V		1-10V	
○ FA53305101-310	359,00 €	○ FA53301201-310	359,00 €	○ FA53301101-310	359,00 €
● FA53305106-310	359,00 €	● FA53301206-310	359,00 €	● FA53301106-310	359,00 €
● FA53305112-310	359,00 €	● FA53301212-310	359,00 €	● FA53301112-310	359,00 €
● FA53305118-310	359,00 €	● FA53301218-310	359,00 €	● FA53301118-310	359,00 €
● FA53305130-310	359,00 €	● FA53301230-310	359,00 €	● FA53301130-310	359,00 €
● FA53305133-310	359,00 €	● FA53301233-310	359,00 €	● FA53301133-310	359,00 €
DALI		DALI		DALI	
○ FA53305101-300	468,00 €	○ FA53301201-300	468,00 €	○ FA53301101-300	468,00 €
● FA53305106-300	468,00 €	● FA53301206-300	468,00 €	● FA53301106-300	468,00 €
● FA53305112-300	468,00 €	● FA53301212-300	468,00 €	● FA53301112-300	468,00 €
● FA53305118-300	468,00 €	● FA53301218-300	468,00 €	● FA53301118-300	468,00 €
● FA53305130-300	468,00 €	● FA53301230-300	468,00 €	● FA53301130-300	468,00 €
● FA53305133-300	468,00 €	● FA53301233-300	468,00 €	● FA53301133-300	468,00 €

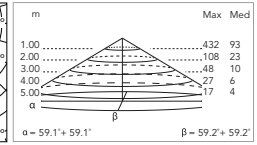
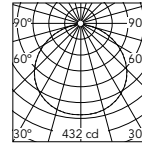

@ 4000K

Platter 310 Grey / Brown Brick

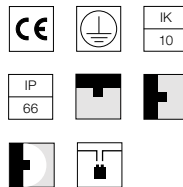
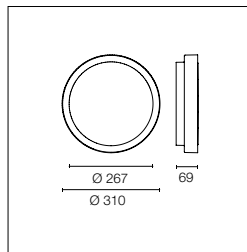

Source LED incluse. Source d'alimentation électrique intégrée 220-240V ON/OFF et intensité réglable entre 1 et 10V ou DALI. Équipé d'une gaine IP65 pour des câbles en caoutchouc de 5mmϕ<math><10\text{mm}</math> et d'une boîte de dérivation à 2 pôles pour des connexions rapides. Pour garantir l'étanchéité de la gaine il est conseillé d'utiliser des câbles électriques flexibles et conçus pour l'extérieur.

LED source included. Integrated power supply 220-240V ON/OFF and dimmable 1-10V or DALI. With IP65 cable guide for rubber cables 5mmϕ<math><10\text{mm}</math> and a 2-pole connection box for a fast connection. To ensure the tightness of the cable guide it's recommended to use flexible electric cables suitable for exterior use.

Mid-Power Led: 18W - 1874 lm \neq OUTPUT 1150 lm - 2700K/CRI 80 - 220 \div 240V / 18W - 2015 lm \neq OUTPUT 1237 lm - 3000K/CRI 80 - 220 \div 240V / 18W - 2168 lm \neq OUTPUT 1330 lm - 4000K/CRI 80 - 220 \div 240V

2700K		3000K		4000K	
Non Dimmable		Non Dimmable		Non Dimmable	
● FA533321	356,00 €	● FA533331	356,00 €	● FA533341	356,00 €
1-10V		1-10V		1-10V	
● FA533321-310	425,00 €	● FA533331-310	425,00 €	● FA533341-310	425,00 €
DALI		DALI		DALI	
● FA533321-300	534,00 €	● FA533331-300	534,00 €	● FA533341-300	534,00 €

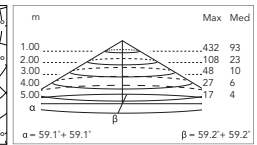
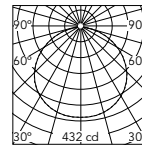

@ 4000K

Platter 310 Anthracite / Pale Blue

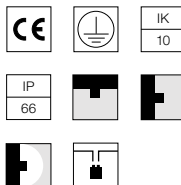
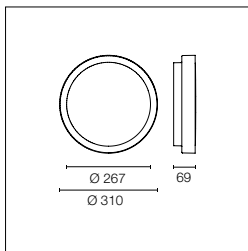

Source LED incluse. Source d'alimentation électrique intégrée 220-240V ON/OFF et intensité réglable entre 1 et 10V ou DALI. Équipé d'une gaine IP65 pour des câbles en caoutchouc de 5mmϕ<math><10\text{mm}</math> et d'une boîte de dérivation à 2 pôles pour des connexions rapides. Pour garantir l'étanchéité de la gaine il est conseillé d'utiliser des câbles électriques flexibles et conçus pour l'extérieur.

LED source included. Integrated power supply 220-240V ON/OFF and dimmable 1-10V or DALI. With IP65 cable guide for rubber cables 5mmϕ<math><10\text{mm}</math> and a 2-pole connection box for a fast connection. To ensure the tightness of the cable guide it's recommended to use flexible electric cables suitable for exterior use.

Mid-Power Led: 18W - 1874 lm \neq OUTPUT 1150 lm - 2700K/CRI 80 - 220÷240V / 18W - 2015 lm \neq OUTPUT 1237 lm - 3000K/CRI 80 - 220÷240V / 18W - 2168 lm \neq OUTPUT 1330 lm - 4000K/CRI 80 - 220÷240V

2700K

Non Dimmable

- FA533322 356,00 €
1-10V
- FA533322-310 425,00 €
Dali
- FA533322-300 534,00 €

3000K

Non Dimmable

- FA533332 356,00 €
1-10V
- FA533332-310 425,00 €
Dali
- FA533332-300 534,00 €

4000K

Non Dimmable

- FA533342 356,00 €
1-10V
- FA533342-310 425,00 €
Dali
- FA533342-300 534,00 €

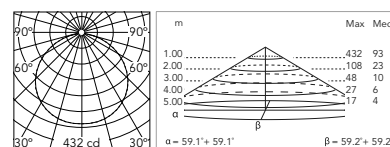

@ 4000K

Platter 310 Deep Brown / Pale Brown

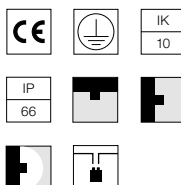
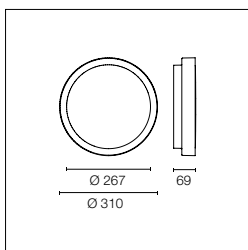

Source LED incluse. Source d'alimentation électrique intégrée 220-240V ON/OFF et intensité réglable entre 1 et 10V ou DALI. Équipé d'une gaine IP65 pour des câbles en caoutchouc de 5mmϕ<math><10\text{mm}</math> et d'une boîte de dérivation à 2 pôles pour des connexions rapides. Pour garantir l'étanchéité de la gaine il est conseillé d'utiliser des câbles électriques flexibles et conçus pour l'extérieur.

LED source included. Integrated power supply 220-240V ON/OFF and dimmable 1-10V or DALI. With IP65 cable guide for rubber cables 5mmϕ<math><10\text{mm}</math> and a 2-pole connection box for a fast connection. To ensure the tightness of the cable guide it's recommended to use flexible electric cables suitable for exterior use.

Mid-Power Led: 18W - 1874 lm \neq OUTPUT 1150 lm - 2700K/CRI 80 - 220÷240V / 18W - 2015 lm \neq OUTPUT 1237 lm - 3000K/CRI 80 - 220÷240V / 18W - 2168 lm \neq OUTPUT 1330 lm - 4000K/CRI 80 - 220÷240V

2700K

Non Dimmable

- FA533323 356,00 €
1-10V
- FA533323-310 425,00 €
Dali
- FA533323-300 534,00 €

3000K

Non Dimmable

- FA533333 356,00 €
1-10V
- FA533333-310 425,00 €
Dali
- FA533333-300 534,00 €

4000K

Non Dimmable

- FA533343 356,00 €
1-10V
- FA533343-310 425,00 €
Dali
- FA533343-300 534,00 €

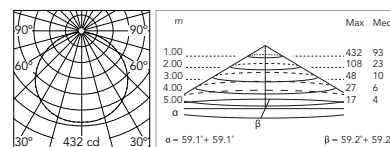

@ 4000K

Platter 310 Forest Green / Olive Green

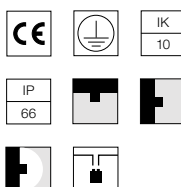
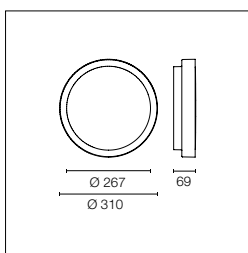

Source LED incluse. Source d'alimentation électrique intégrée 220-240V ON/OFF et intensité réglable entre 1 et 10V ou DALI. Équipé d'une gaine IP65 pour des câbles en caoutchouc de 5mmϕ<math><10\text{mm}</math> et d'une boîte de dérivation à 2 pôles pour des connexions rapides. Pour garantir l'étanchéité de la gaine il est conseillé d'utiliser des câbles électriques flexibles et conçus pour l'extérieur.

LED source included. Integrated power supply 220-240V ON/OFF and dimmable 1-10V or DALI. With IP65 cable guide for rubber cables 5mmϕ<math><10\text{mm}</math> and a 2-pole connection box for a fast connection. To ensure the tightness of the cable guide it's recommended to use flexible electric cables suitable for exterior use.

Mid-Power Led: 18W - 1874 lm \neq OUTPUT 1150 lm - 2700K/CRI 80 - 220÷240V / 18W - 2015 lm \neq OUTPUT 1237 lm - 3000K/CRI 80 - 220÷240V / 18W - 2168 lm \neq OUTPUT 1330 lm - 4000K/CRI 80 - 220÷240V

2700K

Non Dimmable

- FA533324 356,00 €
1-10V
- FA533324-310 425,00 €
Dali
- FA533324-300 534,00 €

3000K

Non Dimmable

- FA533334 356,00 €
1-10V
- FA533334-310 425,00 €
Dali
- FA533334-300 534,00 €

4000K

Non Dimmable

- FA533344 356,00 €
1-10V
- FA533344-310 425,00 €
Dali
- FA533344-300 534,00 €

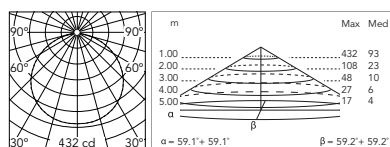

@ 4000K

Platter 210

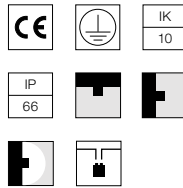
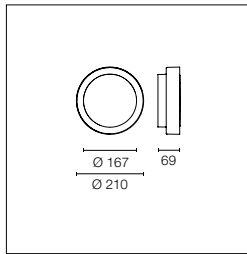

Source LED incluse. Source d'alimentation électrique intégrée 220-240V ON/OFF. Équipé d'une gaine IP65 pour des câbles en caoutchouc de 5mmϕ<math><10\text{mm}</math> et d'une boîte de dérivation à 2 pôles pour des connexions rapides. Pour garantir l'étanchéité de la gaine il est conseillé d'utiliser des câbles électriques flexibles et conçus pour l'extérieur.

LED source included. Integrated electrical power supply 220-240V ON/OFF. With IP65 cable guide for rubber cables 5mmϕ<math><10\text{mm}</math> and a 2-pole connection box for a fast connection. To ensure the tightness of the cable guide it's recommended to use flexible electric cables suitable for exterior use.

Mid-Power Led: 11W - 1202 lm \neq OUTPUT 732 lm - 2700K/CRI 80 - 220÷240V / 11W - 1292 lm \neq OUTPUT 787 lm - 3000K/CRI 80 - 220÷240V / 11W - 1334 lm \neq OUTPUT 812 lm - 4000K/CRI 80 - 220÷240V

2700K

- FA53305001 226,00 €
- FA53305006 226,00 €
- FA53305012 226,00 €
- FA53305018 226,00 €
- FA53305030 226,00 €
- FA53305033 226,00 €

3000K

- FA53300201 226,00 €
- FA53300206 226,00 €
- FA53300212 226,00 €
- FA53300218 226,00 €
- FA53300230 226,00 €
- FA53300233 226,00 €

4000K

- FA53300101 226,00 €
- FA53300106 226,00 €
- FA53300112 226,00 €
- FA53300118 226,00 €
- FA53300130 226,00 €
- FA53300133 226,00 €

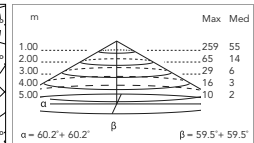
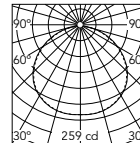

@ 4000K

Platter 210 Grey / Brown Brick

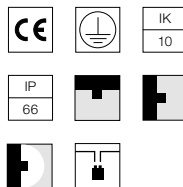
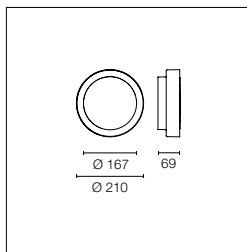

Source LED incluse. Source d'alimentation électrique intégrée 220-240V ON/OFF. Équipé d'une gaine IP65 pour des câbles en caoutchouc de 5mmϕ<math><10\text{mm}</math> et d'une boîte de dérivation à 2 pôles pour des connexions rapides. Pour garantir l'étanchéité de la gaine il est conseillé d'utiliser des câbles électriques flexibles et conçus pour l'extérieur.

LED source included. Integrated electrical power supply 220-240V ON/OFF. With IP65 cable guide for rubber cables 5mmϕ<math><10\text{mm}</math> and a 2-pole connection box for a fast connection. To ensure the tightness of the cable guide it's recommended to use flexible electric cables suitable for exterior use.

Mid-Power Led: 11W - 1261 lm \neq OUTPUT 765 lm - 2700K/CRI 80 - 220÷240V / 11W - 1292 lm \neq OUTPUT 787 lm - 3000K/CRI 80 - 220÷240V / 11W - 1334 lm \neq OUTPUT 812 lm - 4000K/CRI 80 - 220÷240V

2700K

- FA533221 285,00 €

3000K

- FA533231 285,00 €

4000K

- FA533241 285,00 €

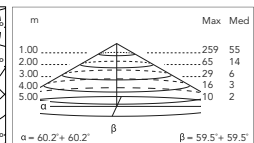
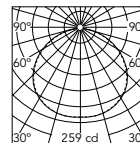

@ 4000K

Platter 210 Anthracite / Pale Blue

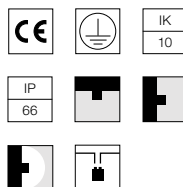
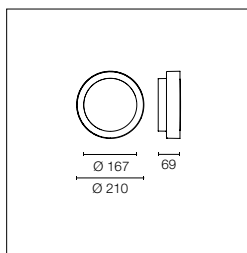

Source LED incluse. Source d'alimentation électrique intégrée 220-240V ON/OFF. Équipé d'une gaine IP65 pour des câbles en caoutchouc de 5mmϕ<math><10\text{mm}</math> et d'une boîte de dérivation à 2 pôles pour des connexions rapides. Pour garantir l'étanchéité de la gaine il est conseillé d'utiliser des câbles électriques flexibles et conçus pour l'extérieur.

LED source included. Integrated electrical power supply 220-240V ON/OFF. With IP65 cable guide for rubber cables 5mmϕ<math><10\text{mm}</math> and a 2-pole connection box for a fast connection. To ensure the tightness of the cable guide it's recommended to use flexible electric cables suitable for exterior use.

Mid-Power Led: 11W - 1202 lm \neq OUTPUT 732 lm - 2700K/CRI 80 - 220÷240V / 11W - 1292 lm \neq OUTPUT 787 lm - 3000K/CRI 80 - 220÷240V / 11W - 1334 lm \neq OUTPUT 812 lm - 4000K/CRI 80 - 220÷240V

2700K

- FA533222 285,00 €

3000K

- FA533232 285,00 €

4000K

- FA533242 285,00 €

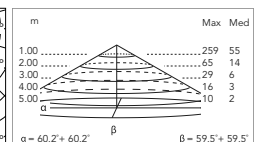
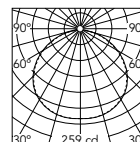

@ 4000K

Platter 210 Deep Brown / Pale Brown

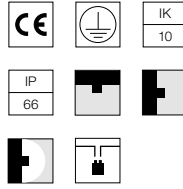
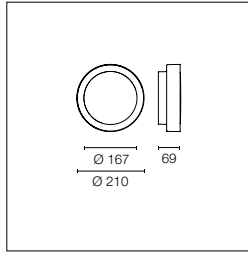

Source LED incluse. Source d'alimentation électrique intégrée 220-240V ON/OFF. Équipé d'une gaine IP65 pour des câbles en caoutchouc de 5mmϕ<math><10\text{mm}</math> et d'une boîte de dérivation à 2 pôles pour des connexions rapides. Pour garantir l'étanchéité de la gaine il est conseillé d'utiliser des câbles électriques flexibles et conçus pour l'extérieur.

LED source included. Integrated electrical power supply 220-240V ON/OFF. With IP65 cable guide for rubber cables 5mmϕ<math><10\text{mm}</math> and a 2-pole connection box for a fast connection. To ensure the tightness of the cable guide it's recommended to use flexible electric cables suitable for exterior use.

Mid-Power Led: 11W - 1202 lm \neq OUTPUT 732 lm - 2700K/CRI 80 - 220 \pm 240V / 11W - 1292 lm \neq OUTPUT 787 lm - 3000K/CRI 80 - 220 \pm 240V / 11W - 1334 lm \neq OUTPUT 812 lm - 4000K/CRI 80 - 220 \pm 240V

2700K

● FA533223

285,00 €

3000K

● FA533233

285,00 €

4000K

● FA533243

285,00 €

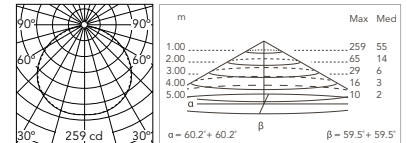

@ 4000K

Platter 210 Forest Green / Olive Green

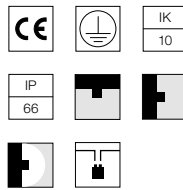
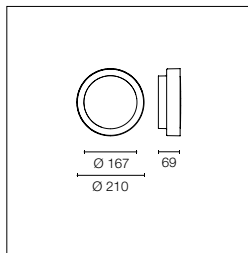

Source LED incluse. Source d'alimentation électrique intégrée 220-240V ON/OFF. Équipé d'une gaine IP65 pour des câbles en caoutchouc de 5mmϕ<math><10\text{mm}</math> et d'une boîte de dérivation à 2 pôles pour des connexions rapides. Pour garantir l'étanchéité de la gaine il est conseillé d'utiliser des câbles électriques flexibles et conçus pour l'extérieur.

LED source included. Integrated electrical power supply 220-240V ON/OFF. With IP65 cable guide for rubber cables 5mmϕ<math><10\text{mm}</math> and a 2-pole connection box for a fast connection. To ensure the tightness of the cable guide it's recommended to use flexible electric cables suitable for exterior use.

Mid-Power Led: 11W - 1202 lm \neq OUTPUT 732 lm - 2700K/CRI 80 - 220 \pm 240V / 11W - 1292 lm \neq OUTPUT 787 lm - 3000K/CRI 80 - 220 \pm 240V / 11W - 1334 lm \neq OUTPUT 812 lm - 4000K/CRI 80 - 220 \pm 240V

2700K

● FA533224

285,00 €

3000K

● FA533234

285,00 €

4000K

● FA533244

285,00 €

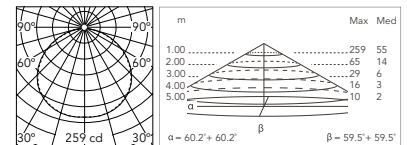

@ 4000K

Platter: Accessoires / Accessories

Dispositif de protection contre les surtensions. 275Vac. Courant de décharge maximal 10KA (8/20 μ s). Courant de fonctionnement maximal 5A. Adapté pour les connexions en séries. IP66.

Surge protection device. 275Vac. Maximum discharge current 10KA (8/20 μ s). Maximum operating current 5A. Suitable for series connection. IP66.

F990E00A000 116,00 €

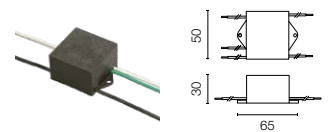

Leila







Famille / Family

Leila 1



CoB Led

up to 14W
up to 941 lm - 2700K/CRI 80
up to 980 lm - 3000K/CRI 80
up to 1073 lm - 4000K/CRI 80
* Net lumen output

Leila 2



CoB Led

up to 14W
up to 1457 lm - 2700K/CRI 80
up to 1567 lm - 3000K/CRI 80
up to 1653 lm - 4000K/CRI 80
* Net lumen output

Leila 3



CoB Led

up to 28W
up to 2380 lm - 2700K/CRI 80
up to 2559 lm - 3000K/CRI 80
up to 2700 lm - 4000K/CRI 80
* Net lumen output

Leila 4



CoB Led

up to 40W
up to 3443 lm - 2700K/CRI 80
up to 3742 lm - 3000K/CRI 80
up to 3929 lm - 4000K/CRI 80
* Net lumen output

Finitions / Colours



01 White

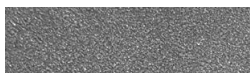

56 Matt Stainless Steel

Description / Description

Famille de luminaires avec source LED pour installation encastrée au plafond et sur des faux plafonds en placoplâtre. Les luminaires sont caractérisés par leur forme ronde. Disponibles en quatre tailles et avec différentes ouvertures du faisceau lumineux pour chaque taille. Structure en aluminium moulé sous pression EN AB-47100 (à faible teneur en cuivre), couvercle extérieur en acier inoxydable AISI 316L soumis à un procédé de grenailage ou verni en blanc mat. Diffuseur en verre texturé avec un bord sérigraphié, fixé au luminaire par un système d'encollage robotisé. Les vis de fixation sont en acier inoxydable AISI 316L. Équipés d'un raccord fileté M12 étanche qui empêche les infiltrations d'eau et facilite une connexion rapide à l'unité de câblage. La source d'alimentation est fournie avec un kit IP67 à distance à placer dans la boîte de dérivation pour l'encastrement aux plafonds de maçonnerie, ou à poser près du luminaire pour l'encastrement dans des faux plafonds. Une boîte de dérivation métallique est disponible en tant qu'accessoire optionnel. Elle est à encastrer pour des installations aux plafonds de maçonnerie ou de béton armé.

Luminaire family with LED source for recessed ceiling and plaster-board false ceiling mounting. Defined by their round shape. Available in four dimensions and different beam angles per dimension. EN AB-47100 die cast aluminum body (with low copper content), AISI 316L stainless steel outer lid, shot-blasted and varnished in matte white. Textured glass diffuser with silkscreen edge, attached to the luminaire with a robotic gluing system. The fixing screws are made of stainless steel AISI 316L. Equipped with a watertight M12 threaded connector that prevents water infiltration and facilitates quick connection to the wiring unit. The power supply is supplied together with a remote IP67 kit to be housed in the junction box in case of recessed installation in a masonry ceiling, or supported directly near the luminaire, in case of recessed installation in a false ceiling. The metal junction box to be recessed in case of installation in masonry or reinforced concrete ceilings is available as an accessory.

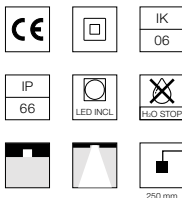
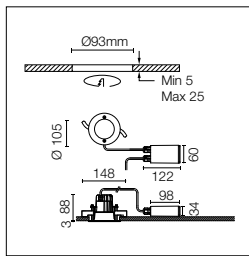

Source LED incluse. Source d'alimentation électrique 220-240V ON/OFF : * kit à distance équipé d'un câble de 400 mm avec un raccord fileté M12 étanche dans le luminaire, ainsi que d'un câble de 250 mm pour la connexion au réseau électrique, à loger dans la boîte de dérivation pour des plafonds de maçonnerie (à commander séparément) ou à poser près du luminaire pour des faux plafonds en placo-plâtre. Version à intensité réglable disponible sur demande.

LED source included. Electrical power supply 220-240V ON/OFF: remote kit with a 400mm cable section with watertight threaded M12 connector on the luminaire and a 250mm cable section for connection on the mains. This needs to be housed in the junction box for masonry ceilings (it needs to be ordered separately) or set next to the luminaire in case of plasterboard false ceilings. Dimmable version available upon request.

Optic Spot 19°

CoB Led: 14W - 941 lm ≠ OUTPUT 859 lm - 2700K/CRI 80 - 220÷240V / 14W - 980 lm ≠ OUTPUT 895 lm - 3000K/CRI 80 - 220÷240V / 14W - 1073 lm ≠ OUTPUT 980 lm - 4000K/CRI 80 - 220÷240V

2700K

3000K

4000K

- FA53610901 300,00 € ○ FA53600901 300,00 € ○ FA53600801 300,00 €
- FA53610356 300,00 € ● FA53600356 300,00 € ● FA53600256 300,00 €

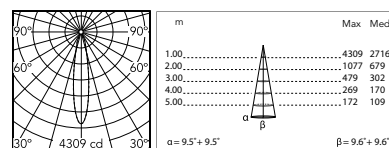

@ 3000K

Optic Medium 43°

CoB Led: 14W - 941 lm ≠ OUTPUT 941 lm - 2700K/CRI 80 - 220÷240V / 14W - 980 lm ≠ OUTPUT 980 lm - 3000K/CRI 80 - 220÷240V / 14W - 1073 lm ≠ OUTPUT 1073 lm - 4000K/CRI 80 - 220÷240V

2700K

3000K

4000K

- FA53611201 300,00 € ○ FA53601201 300,00 € ○ FA53601101 300,00 €
- FA53610656 300,00 € ● FA53600656 300,00 € ● FA53600556 300,00 €

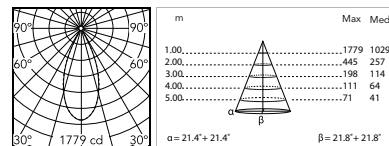

@ 3000K

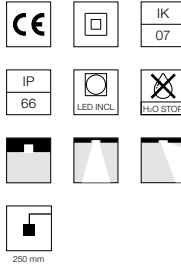
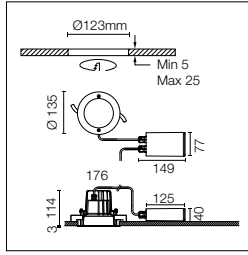

Source LED incluse. Source d'alimentation électrique intégrée 220-240V ON/ OFF et intensité réglable entre 1 y 10V o DALI: kit à distance équipé d'un câble de 400 mm avec un raccord fileté M12 étanche dans le luminaire, ainsi que d'un câble de 250 mm pour la connexion au réseau électrique, à loger dans la boîte de dérivation pour des plafonds de maçonnerie (à commander séparément) ou à poser près du luminaire pour des faux plafonds en placoplâtre. Version à intensité réglable disponible sur demande.

LED source included. Integrated power supply 220-240V ON/ OFF and dimmable 1-10V or DALI: remote kit with a 400mm cable section with watertight threaded M12 connector on the luminaire and a 250mm cable section for connection on the mains. This needs to be housed in the junction box for masonry ceilings (it needs to be ordered separately) or set next to the luminaire in case of plasterboard false ceilings. Dimmable version available upon request.

Optic Spot 24°

CoB Led: 14W - 1457 lm ≠ OUTPUT 1457 lm - 2700K/CRI 80 - 220÷240V / 14W - 1567 lm ≠ OUTPUT 1567 lm - 3000K/CRI 80 - 220÷240V / 14W - 1653 lm ≠ OUTPUT 1653 lm - 4000K/CRI 80 - 220÷240V

2700K		3000K		4000K	
Non Dimmable		Non Dimmable		Non Dimmable	
○ FA53612201.A	378,00 €	○ FA53602201	378,00 €	○ FA53602101.A	378,00 €
● FA53611456.A	378,00 €	● FA53601456	378,00 €	● FA53601356.A	378,00 €
1-10V					
○ FA53612201-310.A	474,00 €	○ FA53602201-310	474,00 €	○ FA53602101-310.A	474,00 €
● FA53611456-310.A	474,00 €	● FA53601456-310	474,00 €	● FA53601356-310.A	474,00 €
Dali					
○ FA53612201-300.A	478,00 €	○ FA53602201-300	478,00 €	○ FA53602101-300.A	478,00 €
● FA53611456-300.A	478,00 €	● FA53601456-300	478,00 €	● FA53601356-300.A	478,00 €

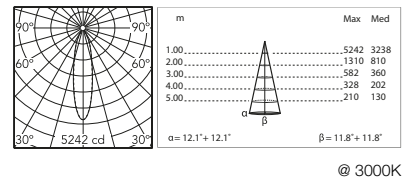

@ 3000K

Optic Medium 37°

CoB Led: 14W - 1457 lm ≠ OUTPUT 1365 lm - 2700K/CRI 80 - 220÷240V / 14W - 1567 lm ≠ OUTPUT 1468 lm - 3000K/CRI 80 - 220÷240V / 14W - 1653 lm ≠ OUTPUT 1549 lm - 4000K/CRI 80 - 220÷240V

2700K		3000K		4000K	
Non Dimmable		Non Dimmable		Non Dimmable	
○ FA53612401.A	378,00 €	○ FA53602401	378,00 €	○ FA53602301.A	378,00 €
● FA53611656.A	378,00 €	● FA53601656	378,00 €	● FA53601556.A	378,00 €
1-10V					
○ FA53612401-310.A	474,00 €	○ FA53602401-310	474,00 €	○ FA53602301-310.A	474,00 €
● FA53611656-310.A	474,00 €	● FA53601656-310	474,00 €	● FA53601556-310.A	474,00 €
Dali					
○ FA53612401-300.A	478,00 €	○ FA53602401-300	478,00 €	○ FA53602301-300.A	478,00 €
● FA53611656-300.A	478,00 €	● FA53601656-300	478,00 €	● FA53601556-300.A	478,00 €

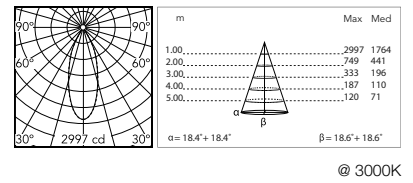

@ 3000K

Asymmetric Optic 12° - 19°

CoB Led: 14W - 1457 lm ≠ OUTPUT 974 lm - 2700K/CRI 80 - 220÷240V / 14W - 1567 lm ≠ OUTPUT 1015 lm - 3000K/CRI 80 - 220÷240V / 14W - 1653 lm ≠ OUTPUT 1111 lm - 4000K/CRI 80 - 220÷240V

2700K		3000K		4000K	
Non Dimmable		Non Dimmable		Non Dimmable	
○ FA53612601	378,00 €	○ FA53602601	378,00 €	○ FA53602501	378,00 €
● FA53611856	378,00 €	● FA53601856	378,00 €	● FA53601756	378,00 €
1-10V					
○ FA53612601-310	474,00 €	○ FA53602601-310	474,00 €	○ FA53602501-310	474,00 €
● FA53611856-310	474,00 €	● FA53601856-310	474,00 €	● FA53601756-310	474,00 €
Dali					
○ FA53612601-300	478,00 €	○ FA53602601-300	478,00 €	○ FA53602501-300	478,00 €
● FA53611856-300	478,00 €	● FA53601856-300	478,00 €	● FA53601756-300	478,00 €

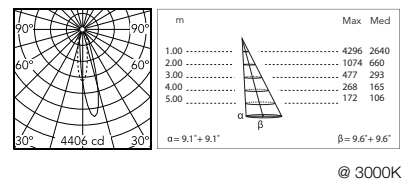

@ 3000K

Asymmetric Optic 12° - 53°

CoB Led: 14W - 1457 lm ≠ OUTPUT 1209 lm - 2700K/CRI 80 - 220÷240V / 14W - 1567 lm ≠ OUTPUT 1259 lm - 3000K/CRI 80 - 220÷240V / 14W - 1653 lm ≠ OUTPUT 1379 lm - 4000K/CRI 80 - 220÷240V

2700K		3000K		4000K	
Non Dimmable		Non Dimmable		Non Dimmable	
○ FA53612801	378,00 €	○ FA53602801	378,00 €	○ FA53602701	378,00 €
● FA53612056	378,00 €	● FA53602056	378,00 €	● FA53601956	378,00 €
1-10V					
○ FA53612801-310	474,00 €	○ FA53602801-310	474,00 €	○ FA53602701-310	474,00 €
● FA53612056-310	474,00 €	● FA53602056-310	474,00 €	● FA53601956-310	474,00 €
Dali					
○ FA53612801-300	478,00 €	○ FA53602801-300	478,00 €	○ FA53602701-300	478,00 €
● FA53612056-300	478,00 €	● FA53602056-300	478,00 €	● FA53601956-300	478,00 €

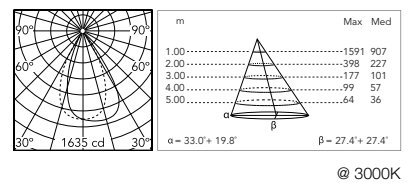

@ 3000K

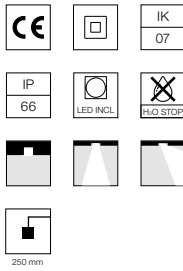
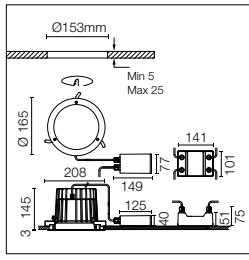

Source LED incluse. Source d'alimentation électrique intégrée 220-240V ON/ OFF et intensité réglable entre 1 y 10V o DALI: kit à distance équipé d'un câble de 400 mm avec un raccord fileté M12 étanche dans le luminaire, ainsi que d'un câble de 250 mm pour la connexion au réseau électrique, à loger dans la boîte de dérivation pour des plafonds de maçonnerie (à commander séparément) ou à poser près du luminaire pour des faux plafonds en placo-plâtre. Version à intensité réglable disponible sur demande.

LED source included. Integrated power supply 220-240V ON/ OFF and dimmable 1-10V or DALI: remote kit with a 400mm cable section with watertight threaded M12 connector on the luminaire and a 250mm cable section for connection on the mains. This needs to be housed in the junction box for masonry ceilings (it needs to be ordered separately) or set next to the luminaire in case of plasterboard false ceilings. Dimmable version available upon request.

Optic Spot 17°

CoB Led: 28W - 2380 lm ≠ OUTPUT 2380 lm - 2700K/CRI 80 - 220÷240V / 28W - 2559 lm ≠ OUTPUT 2559 lm - 3000K/CRI 80 - 220÷240V / 28W - 2700 lm ≠ OUTPUT 2700 lm - 4000K/CRI 80 - 220÷240V

2700K

Non Dimmable	
○ FA53613801.A	457,00 €
● FA53613056.A	457,00 €
1-10V	
○ FA53613801-310.A	535,00 €
● FA53613056-310.B	535,00 €
Dali	
○ FA53613801-300.B	547,00 €
● FA53613056-300.B	547,00 €

3000K

Non Dimmable	
○ FA53603801	457,00 €
● FA53603056	457,00 €
1-10V	
○ FA53603801-310	535,00 €
● FA53603056-310	535,00 €
Dali	
○ FA53603801-300.A	547,00 €
● FA53603056-300.B	547,00 €

4000K

Non Dimmable	
○ FA53603701.A	457,00 €
● FA53602956.A	457,00 €
1-10V	
○ FA53603701-310.A	535,00 €
● FA53602956-310.A	535,00 €
Dali	
○ FA53603701-300.B	547,00 €
● FA53602956-300.B	547,00 €

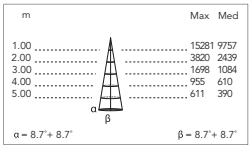
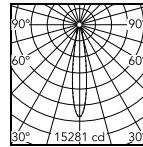

@ 3000K

Optic Medium 44°

CoB Led: 28W - 2380 lm ≠ OUTPUT 2325 lm - 2700K/CRI 80 - 220÷240V / 28W - 2559 lm ≠ OUTPUT 2500 lm - 3000K/CRI 80 - 220÷240V / 28W - 2700 lm ≠ OUTPUT 2638 lm - 4000K/CRI 80 - 220÷240V

2700K

Non Dimmable	
○ FA53614001.A	457,00 €
● FA53613256.A	457,00 €
1-10V	
○ FA53614001-310.A	535,00 €
● FA53613256-310.A	535,00 €
Dali	
○ FA53614001-300.B	547,00 €
● FA53613256-300.B	547,00 €

3000K

Non Dimmable	
○ FA53604001	457,00 €
● FA53603256	457,00 €
1-10V	
○ FA53604001-310	535,00 €
● FA53603256-310	535,00 €
Dali	
○ FA53604001-300.A	547,00 €
● FA53603256-300.A	547,00 €

4000K

Non Dimmable	
○ FA53603901.A	457,00 €
● FA53603156.A	457,00 €
1-10V	
○ FA53603901-310.A	535,00 €
● FA53603156-310.A	535,00 €
Dali	
○ FA53603901-300.B	547,00 €
● FA53603156-300.B	547,00 €

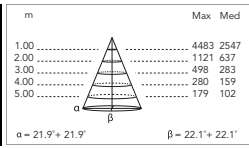
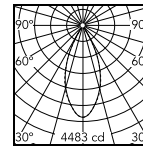

@ 3000K

Asymmetric Optic 12° - 29°

CoB Led: 28W - 2380 lm ≠ OUTPUT 2199 lm - 2700K/CRI 80 - 220÷240V / 28W - 2559 lm ≠ OUTPUT 2364 lm - 3000K/CRI 80 - 220÷240V / 28W - 2700 lm ≠ OUTPUT 2494 lm - 4000K/CRI 80 - 220÷240V

2700K

Non Dimmable	
○ FA53614201.A	457,00 €
● FA53613456.A	457,00 €
1-10V	
○ FA53614201-310.A	535,00 €
● FA53613456-310.A	535,00 €
Dali	
○ FA53614201-300.A	547,00 €
● FA53613456-300.B	547,00 €

3000K

Non Dimmable	
○ FA53604201	457,00 €
● FA53603456	457,00 €
1-10V	
○ FA53604201-310	535,00 €
● FA53603456-310.A	535,00 €
Dali	
○ FA53604201-300.A	547,00 €
● FA53603456-300.A	547,00 €

4000K

Non Dimmable	
○ FA53604101.A	457,00 €
● FA53603356.A	457,00 €
1-10V	
○ FA53604101-310.A	535,00 €
● FA53603356-310.A	535,00 €
Dali	
○ FA53604101-300.B	547,00 €
● FA53603356-300.A	547,00 €

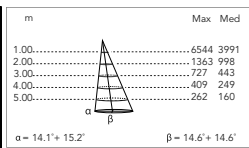
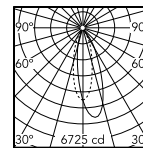

@ 3000K

Asymmetric Optic 12° - 37°

CoB Led: 28W - 2380 lm ≠ OUTPUT 2105 lm - 2700K/CRI 80 - 220÷240V / 28W - 2559 lm ≠ OUTPUT 2263 lm - 3000K/CRI 80 - 220÷240V / 28W - 2700 lm ≠ OUTPUT 2387 lm - 4000K/CRI 80 - 220÷240V

2700K

Non Dimmable	
○ FA53614401.A	457,00 €
● FA53613656.A	457,00 €
1-10V	
○ FA53614401-310.B	535,00 €
● FA53613656-310.A	535,00 €
Dali	
○ FA53614401-300.B	547,00 €
● FA53613656-300.B	547,00 €

3000K

Non Dimmable	
○ FA53604401	457,00 €
● FA53603656	457,00 €
1-10V	
○ FA53604401-310	535,00 €
● FA53603656-310	535,00 €
Dali	
○ FA53604401-300.A	547,00 €
● FA53603656-300.B	547,00 €

4000K

Non Dimmable	
○ FA53604301.A	457,00 €
● FA53603556.A	457,00 €
1-10V	
○ FA53604301-310.A	535,00 €
● FA53603556-310.A	535,00 €
Dali	
○ FA53604301-300.B	547,00 €
● FA53603556-300.B	547,00 €

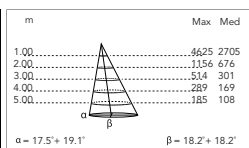
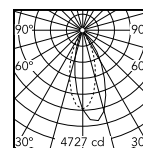

@ 3000K

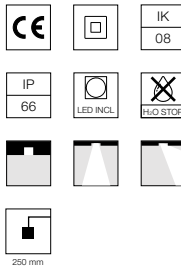
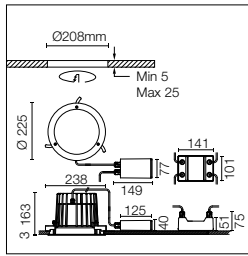

Source LED incluse. Source d'alimentation électrique intégrée 220-240V ON/ OFF et intensité réglable entre 1 y 10V o DALI: kit à distance équipé d'un câble de 400 mm avec un raccord fileté M12 étanche dans le luminaire, ainsi que d'un câble de 250 mm pour la connexion au réseau électrique, à loger dans la boîte de dérivation pour des plafonds de maçonnerie (à commander séparément) ou à poser près du luminaire pour des faux plafonds en placoplâtre. Version à intensité réglable disponible sur demande.

LED source included. Integrated power supply 220-240V ON/ OFF and dimmable 1-10V or DALI: remote kit with a 400mm cable section with watertight threaded M12 connector on the luminaire and a 250mm cable section for connection on the mains. This needs to be housed in the junction box for masonry ceilings (it needs to be ordered separately) or set next to the luminaire in case of plasterboard false ceilings. Dimmable version available upon request.

Optic Medium 45°

CoB Led: 40W - 3443 lm ≠ OUTPUT 3443 lm - 2700K/CRI 80 - 220÷240V / 40W - 3742 lm ≠ OUTPUT 3742 lm - 3000K/CRI 80 - 220÷240V / 40W - 3929 lm ≠ OUTPUT 3929 lm - 4000K/CRI 80 - 220÷240V

2700K		3000K		4000K	
Non Dimmable		Non Dimmable		Non Dimmable	
○ FA53615601.A	605,00 €	○ FA53605601.A	605,00 €	○ FA53605501.A	605,00 €
● FA53614856.A	605,00 €	● FA53604856.A	605,00 €	● FA53604756.A	605,00 €
1-10V					
○ FA53615601-310.A	715,00 €	○ FA53605601-310.A	715,00 €	○ FA53605501-310.A	715,00 €
● FA53614856-310.A	715,00 €	● FA53604856-310.A	715,00 €	● FA53604756-310.A	715,00 €
Dali					
○ FA53615601-300.A	736,00 €	○ FA53605601-300.A	736,00 €	○ FA53605501-300.A	736,00 €
● FA53614856-300.A	736,00 €	● FA53604856-300.A	736,00 €	● FA53604756-300.A	736,00 €

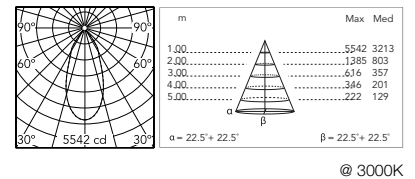

@ 3000K

Asymmetric Optic 12° - 21°

CoB Led: 40W - 3443 lm ≠ OUTPUT 3104 lm - 2700K/CRI 80 - 220÷240V / 40W - 3742 lm ≠ OUTPUT 3338 lm - 3000K/CRI 80 - 220÷240V / 40W - 3929 lm ≠ OUTPUT 3522 lm - 4000K/CRI 80 - 220÷240V

2700K		3000K		4000K	
Non Dimmable		Non Dimmable		Non Dimmable	
○ FA53615801.A	605,00 €	○ FA53605801.A	605,00 €	○ FA53605701.A	605,00 €
● FA53615056.A	605,00 €	● FA53605056.A	605,00 €	● FA53604956.A	605,00 €
1-10V					
○ FA53615801-310.A	715,00 €	○ FA53605801-310.A	715,00 €	○ FA53605701-310.A	715,00 €
● FA53615056-310.A	715,00 €	● FA53605056-310.A	715,00 €	● FA53604956-310.A	715,00 €
Dali					
○ FA53615801-300.A	736,00 €	○ FA53605801-300.A	736,00 €	○ FA53605701-300.A	736,00 €
● FA53615056-300.A	736,00 €	● FA53605056-300.A	736,00 €	● FA53604956-300.A	736,00 €

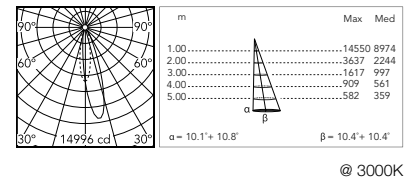

@ 3000K

Asymmetric Optic 12° - 41°

CoB Led: 40W - 3443 lm ≠ OUTPUT 3066 lm - 2700K/CRI 80 - 220÷240V / 40W - 3742 lm ≠ OUTPUT 3297 lm - 3000K/CRI 80 - 220÷240V / 40W - 3929 lm ≠ OUTPUT 3478 lm - 4000K/CRI 80 - 220÷240V

2700K		3000K		4000K	
Non Dimmable		Non Dimmable		Non Dimmable	
○ FA53616001.A	605,00 €	○ FA53606001.A	605,00 €	○ FA53605901.A	605,00 €
● FA53615256.A	605,00 €	● FA53605256.A	605,00 €	● FA53605156.A	605,00 €
1-10V					
○ FA53616001-310.A	715,00 €	○ FA53606001-310.A	715,00 €	○ FA53605901-310.A	715,00 €
● FA53615256-310.A	715,00 €	● FA53605256-310.A	715,00 €	● FA53605156-310.A	715,00 €
Dali					
○ FA53616001-300.A	736,00 €	○ FA53606001-300.A	736,00 €	○ FA53605901-300.A	736,00 €
● FA53615256-300.A	736,00 €	● FA53605256-300.A	736,00 €	● FA53605156-300.A	736,00 €

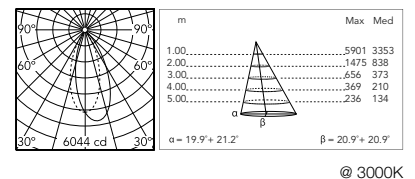

@ 3000K

Leila: Accessoires / Accessories

Boîte en métal pour installation sur des plafonds en ciment.	Metal installation box for concrete ceiling.	Leila 1 FA196	92,00 €		
Boîte en métal pour installation sur des plafonds en ciment.	Metal installation box for concrete ceiling.	Leila 2 FA197	92,00 €		
Boîte en métal pour installation sur des plafonds en ciment.	Metal installation box for concrete ceiling.	Leila 3 FA198	117,00 €		
Boîte en métal pour installation sur des plafonds en ciment.	Metal installation box for concrete ceiling.	Leila 4 FA199	117,00 €		
Système de jonction IP68 H ₂ O Stop anti-condensation à 2 voies 4 pôles. (ø5,5÷12mm câble).	2 way terminal block 4 poles IP68 H ₂ O Stop. (ø5,5÷12mm cable).	F990C00A000	33,00 €		
Système de jonction IP68 H ₂ O Stop anti-condensation à 3/4 voies 4 pôles. (ø5,5÷12mm câble).	3/4 way terminal block 4 poles IP68 H ₂ O Stop. (ø5,5÷12mm cable).	F990C010000	60,00 €		
Dispositif de protection contre les surtensions. 275Vac. Courant de décharge maximal 10KA (8/20µs). Courant de fonctionnement maximal 5A. Adapté pour les connexions en séries. IP66.	Surge protection device. 275Vac. Maximum discharge current 10KA (8/20µs). Maximum operating current 5A. Suitable for series connection. IP66.	F990E00A000	116,00 €		

Kirk





Kirk



Famille / Family

Kirk 1



CoB Led

up to 6W
up to 270 lm - 3000K/CRI 80
* Net lumen output

Kirk 2



CoB Led

up to 12W
up to 713 lm - 3000K/CRI 80
* Net lumen output

Kirk 3



CoB Led

up to 24W
up to 1610 lm - 3000K/CRI 80
* Net lumen output

Finitions / Colours



01 White



06 Grey

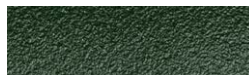

12 Forest Green



18 Deep Brown



30 Black



33 Anthracite

Description / Description

Famille de luminaires de projection ajustable, avec source LED, conçus pour des installations au plafond, au mur et au sol à l'aide d'un clou métallique à commander séparément. Les luminaires sont disponibles en trois tailles. Structure en aluminium usiné par tournage, alliage EN AW 6060 et équerre de maintien en acier inoxydable AISI 316L. Diffuseur en verre extra-clair avec un bord sérigraphié, fixé par un système d'encollage robotisé. Disponibles en différentes finitions avec un revêtement à poudre double couche et une surface traitée par procédé de conversion chimique pour garantir une haute résistance à la corrosion. L'unité de câblage est équipée d'un connecteur IP68 et elle est connectée à l'unité d'émission par un raccord réglable permettant une orientation d'environ 130° sur l'axe vertical. L'équerre de maintien permet une orientation de 90° sur l'axe horizontal pour pouvoir ajuster le faisceau lumineux en fonction des besoins.

Family of tiltable projection luminaires with LED source, designed for ceiling, wall and ground mounting with a metal nail that needs to be ordered separately. Available in three dimensions. Turned aluminum body, EN AW6060 alloy and AISI 316L stainless steel bracket. Extraclear glass diffuser with silkscreen edge, attached with a robotic gluing system. Available in different finishes, with double-layered powder coating and chemical conversion surface treatment to ensure high corrosion resistance. The cable unit has a IP68 connector, connected to the emission unit by means of an adjustable joint so it can be tilted approx. 130° on the vertical axis. The fixing bracket allows for a tilting of 90° on the horizontal axis, so the light beam can be directed according to your needs.

Kirk 1

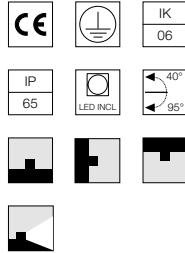
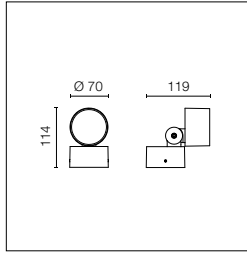

Source LED incluse. Module LED configuré pour travailler directement sur le réseau électrique 220-230V ON/OFF. Équerre de maintien incluse. Équipé d'un connecteur IP68 pour des câbles en caoutchouc de 6mm\varnothing<math><8\text{mm}</math>. Pour garantir l'étanchéité de la gaine il est conseillé d'utiliser des câbles électriques flexibles et conçus pour l'extérieur. Clou métallique pour installation au so doit être commandée séparément.

LED source included. LED module configured to work directly on the mains 220-230V ON/OFF. Fixing bracket included. IP68 connector for 6mm\varnothing<math><8\text{mm}</math> rubber cable. To ensure the tightness of the cable guide it's recommended to use flexible electric cables suitable for exterior use. Ground spike to be ordered separately.

Optic Medium 50°

CoB Led: 6W - 387 lm \neq OUTPUT 270 lm - 3000K/CRI 80 - 220-230V

3000K

○ FA54000101.A	228,00 €
● FA54000106.A	228,00 €
● FA54000112.A	228,00 €
● FA54000118.A	228,00 €
● FA54000130.A	228,00 €
● FA54000133.A	228,00 €

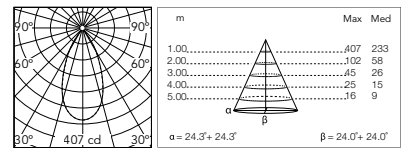

Kirk 2

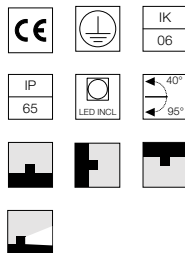
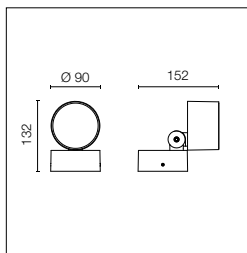

Source LED incluse. Module LED configuré pour travailler directement sur le réseau électrique 220-230V ON/OFF. Équerre de maintien incluse. Équipé d'un connecteur IP68 pour des câbles en caoutchouc de 6mm\varnothing<math><8\text{mm}</math>. Pour garantir l'étanchéité de la gaine il est conseillé d'utiliser des câbles électriques flexibles et conçus pour l'extérieur. Clou métallique pour installation au so doit être commandée séparément.

LED source included. LED module configured to work directly on the mains 220-230V ON/OFF. Fixing bracket included. IP68 connector for 6mm\varnothing<math><8\text{mm}</math> rubber cable. To ensure the tightness of the cable guide it's recommended to use flexible electric cables suitable for exterior use. Ground spike to be ordered separately.

Optic Medium 30°

CoB Led: 12W - 951 lm \neq OUTPUT 713 lm - 3000K/CRI 80 - 220-230V

3000K

○ FA54000201.A	306,00 €
● FA54000206.A	306,00 €
● FA54000212.A	306,00 €
● FA54000218.A	306,00 €
● FA54000230.A	306,00 €
● FA54000233.A	306,00 €

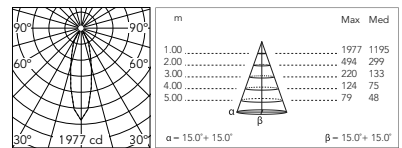

Kirk 3

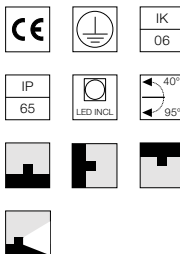
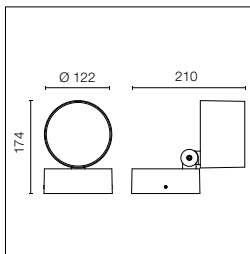

Source LED incluse. Module LED configuré pour travailler directement sur le réseau électrique 220-230V ON/OFF. Équerre de maintien incluse. Équipé d'un connecteur IP68 pour des câbles en caoutchouc de 6mm\times8mm. Pour garantir l'étanchéité de la gaine il est conseillé d'utiliser des câbles électriques flexibles et conçus pour l'extérieur. Clou métallique pour installation au sol doit être commandée séparément.

LED source included. LED module configured to work directly on the mains 220-230V ON/OFF. Fixing bracket included. IP68 connector for 6mm\times8mm rubber cable. To ensure the tightness of the cable guide it's recommended to use flexible electric cables suitable for exterior use. Ground spike to be ordered separately.

Optic Medium 40°





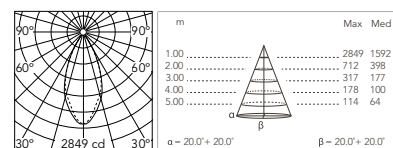

CoB Led: 24W - 2303 lm \neq OUTPUT 1610 lm - 3000K/CRI 80 - 220-230V

3000K

- FA54000301 383,00 €
- FA54000306 383,00 €
- FA54000312 383,00 €
- FA54000318 383,00 €
- FA54000330 383,00 €
- FA54000333 383,00 €

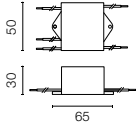

Kirk: Accessoires / Accessories

Pique pour la fixation au sol.	Ground spike.	Kirk 1 FA264	45,00 €		
Pique pour la fixation au sol.	Ground spike.	Kirk 2 FA266	49,00 €		
Pique pour la fixation au sol.	Ground spike.	Kirk 3 FA268	54,00 €		
Dispositif de protection contre les surtensions. 275Vac. Courant de décharge maximal 10KA (8/20 μ s). Courant de fonctionnement maximal 5A. Adapté pour les connexions en séries. IP66.	Surge protection device. 275Vac. Maximum discharge current 10KA (8/20 μ s). Maximum operating current 5A. Suitable for series connection. IP66.	F990E00A000	116,00 €		

Spock

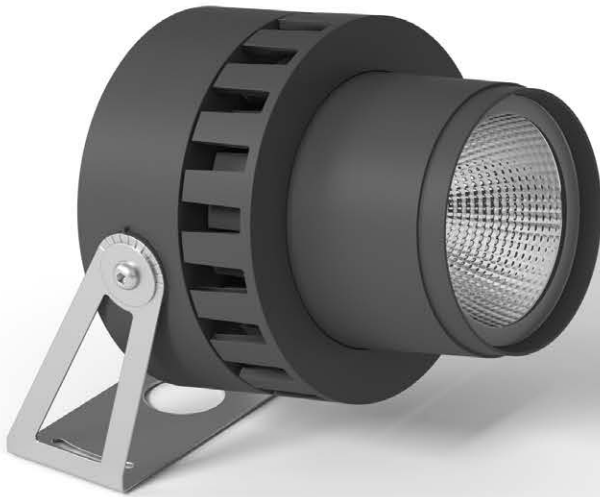



Spock



Famille / Family

Spock 1



CoB Led
up to 11W
up to 725 lm - 2700K/CRI 80
up to 780 lm - 3000K/CRI 80
up to 811 lm - 4000K/CRI 80
* Net lumen output

Spock 2



CoB Led
up to 27W
up to 2153 lm - 2700K/CRI 80
up to 2315 lm - 3000K/CRI 80
up to 2128 lm - 4000K/CRI 80
* Net lumen output

Spock 3



CoB Led
up to 43W
up to 4059 lm - 2700K/CRI 80
up to 4385 lm - 3000K/CRI 80
up to 4477 lm - 4000K/CRI 80
* Net lumen output

Tunable White

CoB Led
up to 38W
up to 2200 lm - 2700K/CRI 80
* Net lumen output

Finitions / Colours



01 White



06 Grey

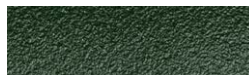

12 Forest Green



18 Deep Brown



30 Black



33 Anthracite

Description / Description

Famille de luminaires de projection ajustable, avec source LED, conçus pour des installations au plafond, au mur et au sol à l'aide d'un clou métallique à commander séparément. Les luminaires sont disponibles en trois tailles et avec deux ouvertures du faisceau lumineux pour chaque taille. Structure et dissipateur de chaleur en aluminium usiné par tournage, alliage EN AW 6060. Diffuseur en verre extra-clair pour la version standard et en verre albarino pour la version Tunable White, avec un bord sérigraphié et fixé par un système d'encollage robotisé. Disponibles en différentes finitions avec un revêtement à poudre double couche et une surface traitée par procédé de conversion chimique pour garantir une haute résistance à la corrosion. Équerre de maintien en acier inoxydable AISI 316L, graduée pour garantir un ajustement précis de l'unité d'émission et une orientation d'environ 180° sur l'axe vertical. L'équerre de maintien permet une orientation minimale de 30° sur l'axe horizontal pour ajuster le faisceau lumineux en fonction des besoins. Équipé d'un câble sortant pour faciliter la connexion. La série est complétée par des viseurs optiques optionnels pour régler le faisceau lumineux émis.

Family of tiltable projection luminaires with LED source, designed for ceiling, wall and ground mounting with a metal nail that needs to be ordered separately. Available in three dimensions and two beam angles per dimension. Body and heat sink made of turned aluminum, alloy EN AW 6060. Diffuser in extraclear glass for the standard version and in amber glass for the Tunable White version, with silkscreen edge and fixed with a robotic gluing system. Available in different finishes, with double-layered powder coating and chemical conversion surface treatment to ensure high corrosion resistance. AISI 316L stainless steel fixing bracket, graduated to guarantee precision in the adjustment of the emission unit and a tilting of approx. 180° in the vertical axis. The fixing bracket allows also for a tilting of 30° on the horizontal axis, so the light beam can be directed according to your needs. With a neoprene cable section to ease the connection. The series is completed with optional optical visors to graduate the emitted light beam.

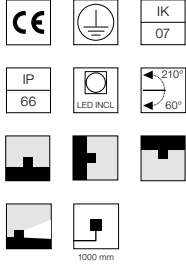
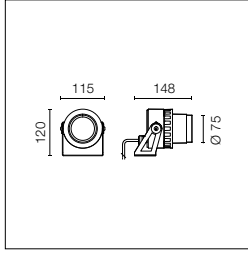

Source LED incluse. Source d'alimentation électrique intégrée 220-240V ON/OFF. Équerre de maintien incluse. Équipé d'un câble sortant de 1000 mm en néoprène, et d'un kit avec des connecteurs sertissables et des gaines thermorétractables adhésives qui garantissent l'étanchéité de la connexion. Des connecteurs IP68 sont disponibles en option. Clou métallique pour l'installation au sol, à commander séparément. Accessoires optionnels pour régler le faisceau lumineux. Version à intensité réglable disponible sur demande.

LED source included. Integrated electrical power supply 220-240V ON/OFF. Fixing bracket included. Equipped with a 1000 mm protruding section of neoprene cable and a kit with crimpable connectors and adhesive heat-shrinkable sleeves that guarantee the tightness of the connection. Optional IP68 connectors available. The metal nail for ground installation needs to be ordered separately. Optional accessories to regulate the light beam. Dimmable version available upon request.

Optic Spot 20°

CoB Led: 11W - 1005 lm ≠ OUTPUT 725 lm - 2700K/CRI 80 - 220-240V / 11W - 1081 lm ≠ OUTPUT 780 lm - 3000K/CRI 80 - 220-240V / 11W - 1124 lm ≠ OUTPUT 811 lm - 4000K/CRI 80 - 220-240V

2700K

○ FA54102301	298,00 €
● FA54102306	298,00 €
● FA54102312	298,00 €
● FA54102318	298,00 €
● FA54102330	298,00 €
● FA54102333	298,00 €

3000K

○ FA54100301	298,00 €
● FA54100306	298,00 €
● FA54100312	298,00 €
● FA54100318	298,00 €
● FA54100330	298,00 €
● FA54100333	298,00 €

4000K

○ FA54100201	298,00 €
● FA54100206	298,00 €
● FA54100212	298,00 €
● FA54100218	298,00 €
● FA54100230	298,00 €
● FA54100233	298,00 €

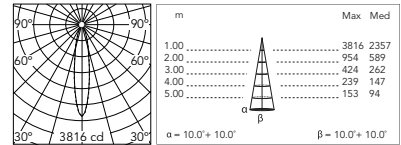

@ 4000K

Optic Medium 50°

CoB Led: 11W - 1005 lm ≠ OUTPUT 697 lm - 2700K/CRI 80 - 220-240V / 11W - 1081 lm ≠ OUTPUT 749 lm - 3000K/CRI 80 - 220-240V / 11W - 1124 lm ≠ OUTPUT 778 lm - 4000K/CRI 80 - 220-240V

2700K

○ FA54102601	298,00 €
● FA54102606	298,00 €
● FA54102612	298,00 €
● FA54102618	298,00 €
● FA54102630	298,00 €
● FA54102633	298,00 €

3000K

○ FA54100601	298,00 €
● FA54100606	298,00 €
● FA54100612	298,00 €
● FA54100618	298,00 €
● FA54100630	298,00 €
● FA54100633	298,00 €

4000K

○ FA54100501	298,00 €
● FA54100506	298,00 €
● FA54100512	298,00 €
● FA54100518	298,00 €
● FA54100530	298,00 €
● FA54100533	298,00 €

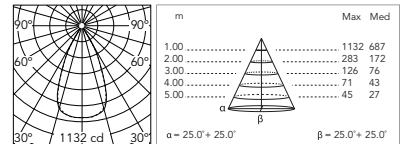

@ 4000K

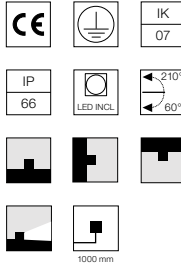
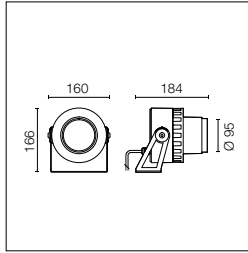

Source LED incluse. Source d'alimentation électrique intégrée 220-240V ON/OFF. Équerre de maintien incluse. Équipé d'un câble sortant de 1000 mm en néoprène, et d'un kit avec des connecteurs sertissables et des gaines thermorétractables adhésives qui garantissent l'étanchéité de la connexion. Des connecteurs IP68 sont disponibles en option. Clou métallique pour l'installation au sol, à commander séparément. Accessoires optionnels pour régler le faisceau lumineux. Version à intensité réglable disponible sur demande.

LED source included. Integrated electrical power supply 220-240V ON/OFF. Fixing bracket included. Equipped with a 1000 mm protruding section of neoprene cable and a kit with crimpable connectors and adhesive heat-shrinkable sleeves that guarantee the tightness of the connection. Optional IP68 connectors available. The metal nail for ground installation needs to be ordered separately. Optional accessories to regulate the light beam. Dimmable version available upon request.

Optic Spot 20°

CoB Led: 27W - 3022 lm ≠ OUTPUT 2141 lm - 2700K/CRI 80 - 220-240V / 27W - 3249 lm ≠ OUTPUT 2302 lm - 3000K/CRI 80 - 220-240V / 27W - 3408 lm ≠ OUTPUT 2415 lm - 4000K/CRI 80 - 220-240V

2700K

- FA54102801.A 453,00 €
- FA54102806.A 453,00 €
- FA54102812.A 453,00 €
- FA54102818.A 453,00 €
- FA54102830.A 453,00 €
- FA54102833.A 453,00 €

3000K

- FA54100801.A 453,00 €
- FA54100806.A 453,00 €
- FA54100812.A 453,00 €
- FA54100818.A 453,00 €
- FA54100830.A 453,00 €
- FA54100833.A 453,00 €

4000K

- FA54100701.A 453,00 €
- FA54100706.A 453,00 €
- FA54100712.A 453,00 €
- FA54100718.A 453,00 €
- FA54100730.A 453,00 €
- FA54100733.A 453,00 €

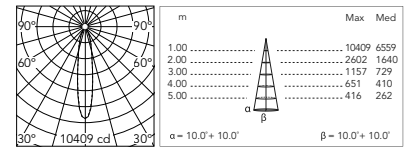

@ 4000K

Optic Medium 40°

CoB Led: 27W - 3022 lm ≠ OUTPUT 2153 lm - 2700K/CRI 80 - 220-240V / 27W - 3249 lm ≠ OUTPUT 2315 lm - 3000K/CRI 80 - 220-240V / 27W - 3408 lm ≠ OUTPUT 2428 lm - 4000K/CRI 80 - 220-240V

2700K

- FA54103001.A 453,00 €
- FA54103006.A 453,00 €
- FA54103012.A 453,00 €
- FA54103018.A 453,00 €
- FA54103030.A 453,00 €
- FA54103033.A 453,00 €

3000K

- FA54101001.A 453,00 €
- FA54101006.A 453,00 €
- FA54101012.A 453,00 €
- FA54101018.A 453,00 €
- FA54101030.A 453,00 €
- FA54101033.A 453,00 €

4000K

- FA54100901.A 453,00 €
- FA54100906.A 453,00 €
- FA54100912.A 453,00 €
- FA54100918.A 453,00 €
- FA54100930.A 453,00 €
- FA54100933.A 453,00 €

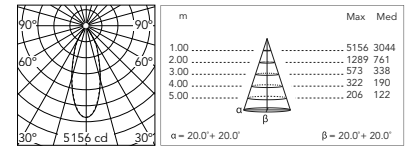

@ 4000K

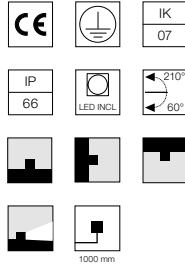
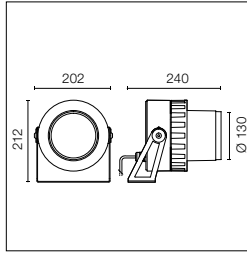

Source LED incluse. Source d'alimentation électrique intégrée 220-240V ON/OFF. Équerre de maintien incluse. Équipé d'un câble sortant de 1000 mm en néoprène, et d'un kit avec des connecteurs sertissables et des gaines thermorétractables adhésives qui garantissent l'étanchéité de la connexion. Des connecteurs IP68 sont disponibles en option. Clou métallique pour l'installation au sol, à commander séparément. Accessoires optionnels pour régler le faisceau lumineux. Version à intensité réglable disponible sur demande.

LED source included. Integrated electrical power supply 220-240V ON/OFF. Fixing bracket included. Equipped with a 1000 mm protruding section of neoprene cable and a kit with crimpable connectors and adhesive heat-shrinkable sleeves that guarantee the tightness of the connection. Optional IP68 connectors available. The metal nail for ground installation needs to be ordered separately. Optional accessories to regulate the light beam. Dimmable version available upon request.

Optic Spot 20°

CoB Led: 43W - 5408 lm ≠ OUTPUT 4059 lm - 2700K/CRI 80 - 220-240V / 43W - 5815 lm ≠ OUTPUT 4365 lm - 3000K/CRI 80 - 220-240V / 43W - 5963 lm ≠ OUTPUT 4477 lm - 4000K/CRI 80 - 220-240V

2700K

○ FA54103201.A	601,00 €
● FA54103206.A	601,00 €
● FA54103212.A	601,00 €
● FA54103218.A	601,00 €
● FA54103230.A	601,00 €
● FA54103233.A	601,00 €

3000K

○ FA54101201.A	601,00 €
● FA54101206.A	601,00 €
● FA54101212.A	601,00 €
● FA54101218.A	601,00 €
● FA54101230.A	601,00 €
● FA54101233.A	601,00 €

4000K

○ FA54101101.A	601,00 €
● FA54101106.A	601,00 €
● FA54101112.A	601,00 €
● FA54101118.A	601,00 €
● FA54101130.A	601,00 €
● FA54101133.A	601,00 €

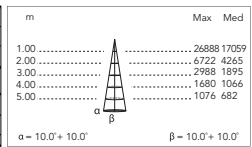
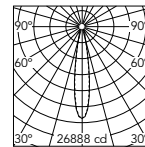

@ 4000K

Optic Medium 45°

CoB Led: 43W - 5408 lm ≠ OUTPUT 3981 lm - 2700K/CRI 80 - 220-240V / 43W - 5815 lm ≠ OUTPUT 4281 lm - 3000K/CRI 80 - 220-240V / 43W - 5963 lm ≠ OUTPUT 4390 lm - 4000K/CRI 80 - 220-240V

2700K

○ FA54103401.A	601,00 €
● FA54103406.A	601,00 €
● FA54103412.A	601,00 €
● FA54103418.A	601,00 €
● FA54103430.A	601,00 €
● FA54103433.A	601,00 €

3000K

○ FA54101401.A	601,00 €
● FA54101406.A	601,00 €
● FA54101412.A	601,00 €
● FA54101418.A	601,00 €
● FA54101430.A	601,00 €
● FA54101433.A	601,00 €

4000K

○ FA54101301.A	601,00 €
● FA54101306.A	601,00 €
● FA54101312.A	601,00 €
● FA54101318.A	601,00 €
● FA54101330.A	601,00 €
● FA54101333.A	601,00 €

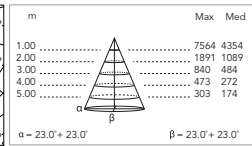
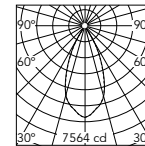

@ 4000K

Spock 3 Tunable White

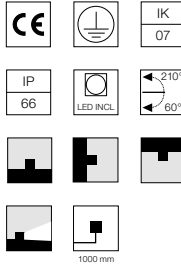
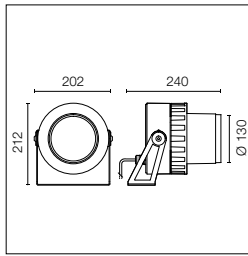

Source LED Tunable White incluse. Source d'alimentation électrique intégrée 120-240V DALI. Équerre de maintien incluse. Équipé d'un câble sortant de 1000 mm en néoprène, et d'un kit avec des connecteurs sertissables et des gaines thermorétractables adhésives qui garantissent l'étanchéité de la connexion. Des connecteurs IP68 sont disponibles en option. Clou métallique pour l'installation au sol, à commander séparément. Accessoires optionnels pour régler le faisceau lumineux. Version à intensité réglable disponible sur demande.

LED Tunable White source included. Integrated electrical power supply 120-240V DALI. Fixing bracket included. Equipped with a 1000 mm protruding section of neoprene cable and a kit with crimpable connectors and adhesive heat-shrinkable sleeves that guarantee the tightness of the connection. Optional IP68 connectors available. The metal nail for ground installation needs to be ordered separately. Optional accessories to regulate the light beam. Dimmable version available upon request.

Optic Spot 20°

CoB Led Tunable White: 38W - 2840 lm ≠ OUTPUT 2200 lm - 2700K ÷ 5700K/CRI>80 - 220-240V

2700K

○ FA54110001	966,00 €
● FA54110006	966,00 €
● FA54110012	966,00 €
● FA54110018	966,00 €
● FA54110030	966,00 €
● FA54110033	966,00 €



Optic Medium 40°

CoB Led Tunable White: 38W - 2840 lm ≠ OUTPUT 2250 lm - 2700K ÷ 5700K/CRI>80 - 220-240V

2700K

○ FA54110201	966,00 €
● FA54110206	966,00 €
● FA54110212	966,00 €
● FA54110218	966,00 €
● FA54110230	966,00 €
● FA54110233	966,00 €

Spock: Accessoires / Accessories

Visière Ø130	Visor Ø130	FA20530	50,00 €		
Visière Ø130	Visor Ø130	FA20630	90,00 €		
Visière Ø130	Visor Ø130	FA20730	102,00 €		
Diffuseur à faisceau large Ø75	Flood diffuser Ø75	FA20830	48,00 €		
Diffuseur à faisceau large Ø95	Flood diffuser Ø95	FA20930	49,00 €		
Diffuseur à faisceau large Ø130	Flood diffuser Ø130	FA21030	65,00 €		
Grille anti-reflet Ø75	Anti-glare louvre Ø75	FA21130	49,00 €		
Grille anti-reflet Ø95	Anti-glare louvre Ø95	FA21230	57,00 €		
Grille anti-reflet Ø130	Anti-glare louvre Ø130	FA21330	65,00 €		
Lentille elliptique Ø75	Elliptical lens Ø75	FA26130	68,00 €		
Lentille elliptique Ø95	Elliptical lens Ø95	FA26230	73,00 €		
Lentille elliptique Ø130	Elliptical lens Ø130	FA26330	94,00 €		

Spock: Accessoires / Accessories

<p>Kit avec 2 piquets pour la fixation au sol.</p>	<p>Kit of 2 ground spikes.</p>	<p>FA203</p>	<p>63,00 €</p>		
<p>Système de jonction IP68 H2O Stop anti-condensation à 3/4 voies 4 pôles. (Ø5,5÷12mm câble).</p>	<p>3/4 way terminal block 4 poles IP68 H2O Stop. (ø5,5÷12mm cable).</p>	<p>F990C010000</p>	<p>60,00 €</p>		
<p>Système de jonction IP68 H2O Stop anti-condensation à 2 voies 4 pôles. (Ø5,5÷12mm câble).</p>	<p>2 way terminal block 4 poles IP68 H2O Stop. (ø5,5÷12mm cable).</p>	<p>F990C00A000</p>	<p>33,00 €</p>		
<p>Dispositif de protection contre les surtensions. 275Vac. Courant de décharge maximal 10KA (8/20µs). Courant de fonctionnement maximal 5A. Adapté pour les connexions en séries. IP66.</p>	<p>Surge protection device. 275Vac. Maximum discharge current 10KA (8/20µs). Maximum operating current 5A. Suitable for series connection. IP66.</p>	<p>F990E00A000</p>	<p>116,00 €</p>		



Aimer





Aimer 2 Pole

Aimer 1 Aqua

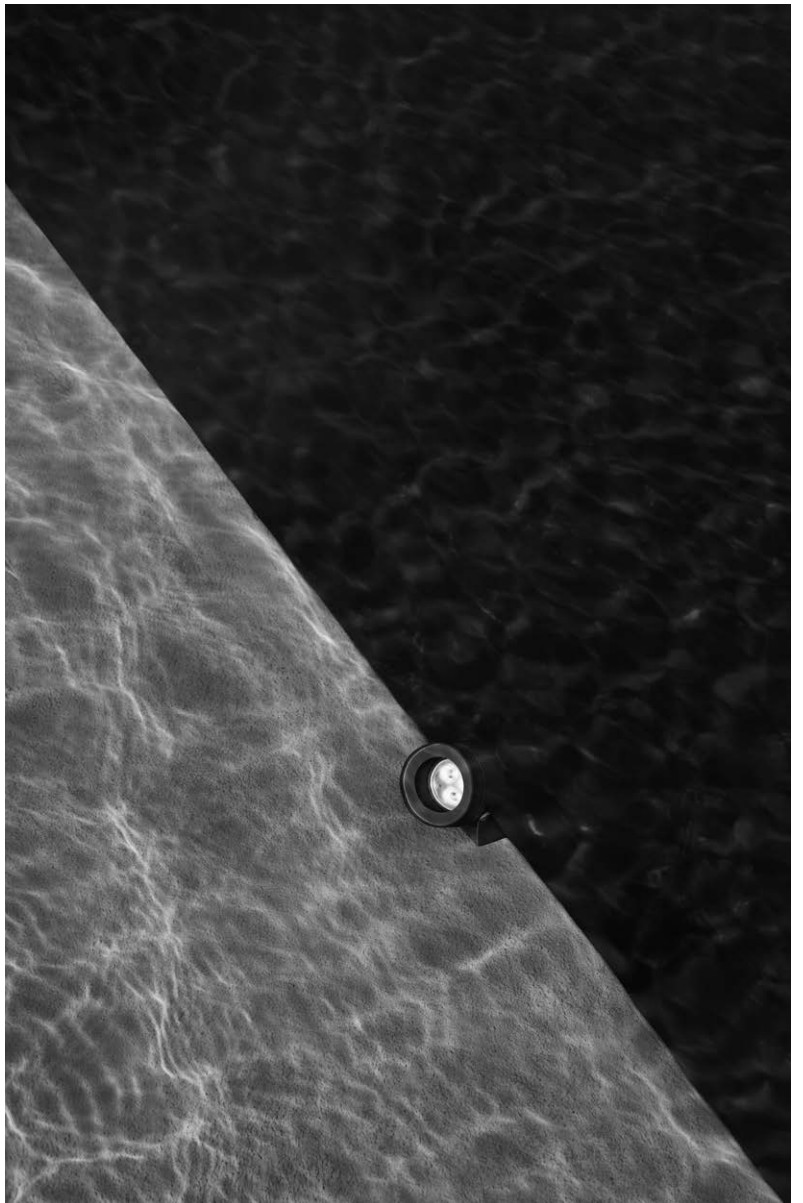



Aimer 1



Power Led

up to 1,1W@350mA / 1,6W@500mA
up to 98@350mA lm / 111@500mA lm - 2700K/CRI 80
up to 106@350mA lm / 121@500mA lm - 3000K/CRI 80
up to 110@350mA lm / 125@500mA lm - 4000K/CRI 80

* Net lumen output

2200K available on request.

Aimer 1 RGB



Power Led

up to 3,4W
up to 3CH x 350mA

* Net lumen output

Aimer 2

Aimer 2 Bollard

Aimer 2 Wall



Power Led

up to 3,4W
up to 138 lm - 2700K/CRI 80
up to 149 lm - 3000K/CRI 80
up to 155 lm - 4000K/CRI 80

* Net lumen output

2200K available on request.

Power Led

up to 3,4W
up to 138 lm - 2700K/CRI 80
up to 149 lm - 3000K/CRI 80
up to 155 lm - 4000K/CRI 80

* Net lumen output

2200K available on request.

Power Led

up to 3,4W
up to 138 lm - 2700K/CRI 80
up to 149 lm - 3000K/CRI 80
up to 155 lm - 4000K/CRI 80

* Net lumen output

2200K available on request.

Power Led

up to 4,5W
up to 246 lm - 2700K/CRI 80
up to 267 lm - 3000K/CRI 80
up to 277 lm - 4000K/CRI 80

* Net lumen output

2200K available on request.

Aimer 3



Power Led

up to 4,5W
up to 359 lm - 2700K/CRI 80
up to 395 lm - 3000K/CRI 80
up to 410 lm - 4000K/CRI 80

* Net lumen output

2200K available on request.

Power Led

up to 3,3W@350mA / 5,1W@500mA
up to 364@350mA lm / 364@500mA lm - 2700K/CRI 80
up to 297@350mA lm / 395@500mA lm - 3000K/CRI 80
up to 308@350mA lm / 410@500mA lm - 4000K/CRI 80

* Net lumen output

2200K available on request.

Aimer 3 RGB



Power Led

up to 3,4W
up to 3CH x 350mA

* Net lumen output

Aimer 4



Power Led

up to 10W
up to 498 lm - 2700K/CRI 80
up to 535 lm - 3000K/CRI 80
up to 570 lm - 4000K/CRI 80

* Net lumen output

2200K available on request.

Aimer 5



Power Led

up to 14W
up to 747 lm - 2700K/CRI 80
up to 803 lm - 3000K/CRI 80
up to 855 lm - 4000K/CRI 80

* Net lumen output

2200K available on request.

Aimer 5 RGB



Power Led

up to 13,6W
up to 3CH x 350mA

* Net lumen output

Famille / Family

Aimer 1 Aqua



Power Led

up to 1,1W
up to 395 lm - 3000K/CRI 80
up to 410 lm - 4000K/CRI 80

* Net lumen output

2200K available on request.

Aimer 1 Aqua RGB



Power Led

up to 3,4W
up to 3CH x 350mA

* Net lumen output

Aimer 3 Aqua



Power Led

up to 4,5W
up to 267 lm - 3000K/CRI 80
up to 278 lm - 4000K/CRI 80

* Net lumen output

2200K available on request.

Aimer 3 Aqua RGB



Power Led

up to 3,4W
up to 3CH x 350mA

* Net lumen output

Aimer 4 Aqua



Power Led

up to 8W
up to 409 lm - 3000K/CRI 80
up to 435 lm - 4000K/CRI 80

* Net lumen output

2200K available on request.

Aimer 5 Aqua



Power Led

up to 11W
up to 680 lm - 3000K/CRI 80
up to 723 lm - 4000K/CRI 80

* Net lumen output

2200K available on request.

Aimer 5 Aqua RGB



Power Led

up to 13,6W
up to 3CH x 350mA

* Net lumen output

Description / Description

Famille complète de luminaires de projection ajustable, avec source LED et conçus pour des installations au plafond, au sol et au mur. Les luminaires se caractérisent par leur forme cylindrique compacte. Disponibles en plusieurs tailles et avec différentes ouvertures du faisceau lumineux. Ils sont complétés par la version RGB pour créer des scénographies avec des lumières de différentes couleurs. Disponibles en différentes finitions avec un revêtement à poudre double couche et une surface traitée par procédé de conversion chimique pour garantir une haute résistance à la corrosion. Les vis de fixation sont en acier inoxydable AISI 316L.

Aimer

Projecteurs de lumière pour des installations au plafond, au mur et au sol à l'aide d'un clou métallique à commander séparément. Disponibles en trois diamètres et avec différentes ouvertures du faisceau lumineux. Structure en aluminium usiné par tournage (EN AW 6060) et anodisé. Diffuseur en verre transparent ou dépoli avec un bord sérigraphié, fixé au ras du bord du luminaire par un système d'encollage robotisé pour éviter les dépôts d'eau. Équerre de maintien en acier inoxydable AISI 316l incluse. Équipés d'un câble sortant pour faciliter la connexion. Disponibles en version 24V dc (connexion en parallèle) ou en version 350/500 mA (connexion en série). Une source d'alimentation à distance est nécessaire pour l'installation, à commander séparément. La série est complétée par des viseurs optionnels pour réduire l'éblouissement direct.

Aqua Aimer

Projecteurs de lumière pour des installations au plafond, au mur et au sol à l'aide d'un clou métallique à commander séparément. Peuvent être immergés à 1 mètre de profondeur (degré de protection IP68). Disponibles en trois diamètres et plusieurs ouvertures du faisceau lumineux. Structure en acier inoxydable AISI 316L. Diffuseur en verre transparent ou dépoli avec un bord sérigraphié, fixé au ras du bord du luminaire par un système d'encollage robotisé pour éviter les dépôts d'eau. Équerre de maintien en acier inoxydable AISI 316l incluse. Équipés d'un câble sortant pour faciliter la connexion. Disponibles en version 24V.

Complete family of tiltable projection luminaires with LED source for wall, ceiling, and ground mounting. Defined by their compact cylinder shape. Available in different dimensions with different beam angles. Completed with the RGB versions to create sceneries with colored light. Available in different finishes, with double-layered powder coating and chemical conversion surface treatment to ensure high corrosion resistance. The fixing screws are made of stainless steel AISI 316L.

Aimer

Light projectors designed for ceiling, wall and ground mounting with a metal nail that needs to be ordered separately. Available in three different diameters and different beam angles. Turned (EN AW 6060) and anodized aluminum body. Transparent or frosted glass diffuser with silkscreen edge, attached flush to the edge with a robotic gluing system to avoid water deposits. AISI 316L Stainless steel bracket included. With a protruding cable section to ease the connection. Available in 24V dc version (parallel connection) or 350/500 mA version (serial connection). A remote power supply is needed and must be ordered separately. The series is completed with optional optical visors to reduce direct dazzling.

Aqua Aimer

Light projectors designed for ceiling, wall and ground mounting with a metal nail that needs to be ordered separately. Suitable for submersion to a depth of 1 meter (IP68 protection degree). Available in three different diameters and different beam angles. AISI 316L stainless steel body. Transparent or frosted glass diffuser with silkscreen edge, attached flush to the edge of the lamp with a robotic gluing system to avoid water deposits. AISI 316L Stainless steel bracket included. With a protruding cable section to ease the connection. Available in 24V version.



01 White



06 Grey



12 Forest Green



18 Deep Brown



30 Black



33 Anthracite



57 Polished Stainless Steel*



70 Anodized Aluminium

* Uniquement pour la version Aimer Aqua. / Only for Aimer Aqua version.

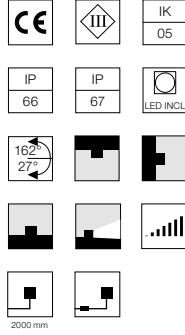
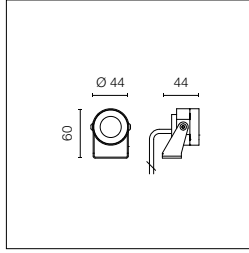

Source LED incluse. Source d'alimentation électrique à distance 350/500 mA ON/ OFF et intensité réglable entre 1 y 10V o DALI, à commander séparément. Connexion en série. Équipé d'un câble sortant de 2000 mm en néoprène, et d'un kit avec des connecteurs sertissables et des gaines thermorétractables adhésives qui garantissent l'étanchéité de la connexion. Verre transparent extra-clair. Clou métallique pour l'installation au sol, à commander séparément.

LED source included. Remote power supply 350/500 mA ON/ OFF and dimmable 1-10V or DALI. Must be ordered separately. Serial connection. Equipped with a 2000 mm protruding section of neoprene cable and a kit with crimpable connectors and adhesive heat-shrinkable sleeves that guarantee the tightness of the connection. Extraclear transparent glass. The metal nail for ground installation needs to be ordered separately.

2200K disponible sur demande.

2200K available on request.

Optic Spot 10°

Power Led: 1,1W@350mA - 110@350mA lm ≠ OUTPUT 98@350mA lm - 1,6W@500mA 144@500mA lm ≠ OUTPUT 111@500mA lm - 2700K/CRI 80
 1,1W@350mA - 120@350mA lm ≠ OUTPUT 106@350mA lm - 1,6W@500mA 155@500mA lm ≠ OUTPUT 121@500mA lm - 3000K/CRI 80
 1,1W@350mA - 124@350mA lm ≠ OUTPUT 110@350mA lm - 1,6W@500mA 161@500mA lm ≠ OUTPUT 125@500mA lm - 4000K/CRI 80

2700K

○ FA1051442201.A	141,00 €
● FA1051442206.A	141,00 €
● FA1051442212.A	141,00 €
● FA1051442218.A	141,00 €
● FA1051442230.A	141,00 €
● FA1051442233.A	141,00 €
● FA1051442270.A	141,00 €

3000K

○ FA1051441201.A	141,00 €
● FA1051441206.A	141,00 €
● FA1051441212.A	141,00 €
● FA1051441218.A	141,00 €
● FA1051441230.A	141,00 €
● FA1051441233.A	141,00 €
● FA1051441270.A	141,00 €

4000K

○ FA1051711201.A	141,00 €
● FA1051711206.A	141,00 €
● FA1051711212.A	141,00 €
● FA1051711218.A	141,00 €
● FA1051711230.A	141,00 €
● FA1051711233.A	141,00 €
● FA1051711270.A	141,00 €

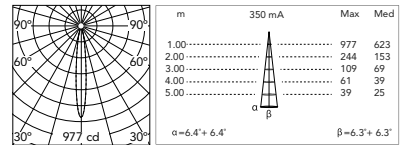

@ 3000K

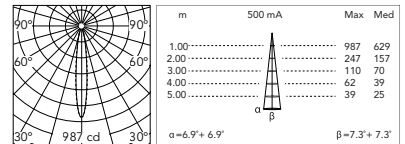

@ 3000K

Optic Medium 30°

Power Led: 1,1W@350mA - 110@350mA lm ≠ OUTPUT 91@350mA lm - 1,6W@500mA 144@500mA lm ≠ OUTPUT 102@500mA lm - 2700K/CRI 80
 1,1W@350mA - 120@350mA lm ≠ OUTPUT 99@350mA lm - 1,6W@500mA 155@500mA lm ≠ OUTPUT 110@500mA lm - 3000K/CRI 80
 1,1W@350mA - 124@350mA lm ≠ OUTPUT 103@350mA lm - 1,6W@500mA 161@500mA lm ≠ OUTPUT 114@500mA lm - 4000K/CRI 80

2700K

○ FA1051442001.A	141,00 €
● FA1051442006.A	141,00 €
● FA1051442012.A	141,00 €
● FA1051442018.A	141,00 €
● FA1051442030.A	141,00 €
● FA1051442033.A	141,00 €
● FA1051442070.A	141,00 €

3000K

○ FA1051440001.A	141,00 €
● FA1051440006.A	141,00 €
● FA1051440012.A	141,00 €
● FA1051440018.A	141,00 €
● FA1051440030.A	141,00 €
● FA1051440033.A	141,00 €
● FA1051440070.A	141,00 €

4000K

○ FA1051710001.A	141,00 €
● FA1051710006.A	141,00 €
● FA1051710012.A	141,00 €
● FA1051710018.A	141,00 €
● FA1051710030.A	141,00 €
● FA1051710033.A	141,00 €
● FA1051710070.A	141,00 €

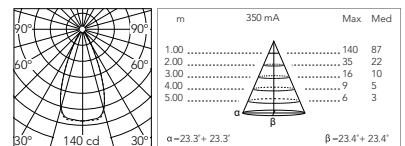

@ 3000K

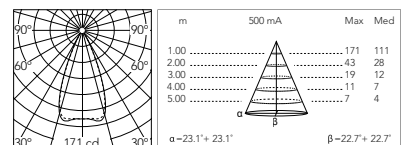

@ 3000K

* Nombre maximum de luminaires par source d'alimentation / Maximum number of luminaires per power supply.

Nombre maximum de luminaires par source d'alimentation (220-240 V). Ces données doivent être vérifiées en prenant en compte les conditions spécifiques d'installation.

Maximum number of luminaires per power supply. (220-240 V). These data must be checked taking into account the specific installation conditions.

Acc. RF25754	6
Acc. RF25748	6
Acc. FA68	10

Acc. FA129	**16
Acc. FA184	**16
Acc. FA135	**12
Acc. FA218	**12
Acc. FA238.A	**9
Acc. FA239.A	**9

**La tension entre les extrémités du système dépend du nombre de luminaires connectés en série. Veuillez vous en tenir à la norme CEI 64-8.

**The voltage at the end of the system depends on the number of fixtures connected in series, please comply with CEI 64-8 standards.

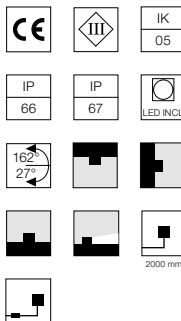
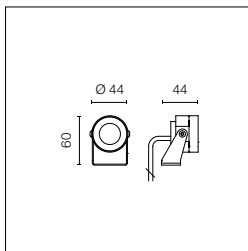

Source LED RGB incluse.
 Source d'alimentation électrique à distance avec interface DMX 3chx350mA à commander séparément. Connexion en série. Équipé d'un câble sortant de 2000 mm en néoprène, et d'un kit avec des connecteurs sertissables et des gaines thermorétractables adhésives qui garantissent l'étanchéité de la connexion.
 Verre sérigraphié sablé.
 Clou métallique pour l'installation au sol, à commander séparément.

RGB LED source included.
 Remote electrical power supply with DMX 3chx350mA interface to be ordered separately. Serial connection. Equipped with a 2000 mm protruding section of neoprene cable and a kit with crimpable connectors and adhesive heat-shrinkable sleeves that guarantee the tightness of the connection.
 Sandblasted screen-printed glass
 The metal nail for ground installation needs to be ordered separately.

Schéma électrique et installation système RGB.

Wiring diagram and installation scheme RGB.

10 luminaires Aimer 1 RGB maximum pour chaque code F990B22A000.

Max 10 luminaires Aimer 1 RGB for each code F990B22A000.

Voir schéma électrique n.5 Page 832.

See Wiring Diagram n.5 Page 832.

RGB Power Led: 3,4W - 3CH x 350mA

RGB

- FA1051730001.A 156,00 €
- FA1051730006.A 156,00 €
- FA1051730012.A 156,00 €
- FA1051730018.A 156,00 €
- FA1051730030.A 156,00 €
- FA1051730033.A 156,00 €
- FA1051730070.A 156,00 €

Photometric data on request.

* Nombre maximum de luminaires par source d'alimentation / Maximum number of luminaires per power supply.

Nombre maximum de luminaires par source d'alimentation (220÷240 V). Ces données doivent être vérifiées en prenant en compte les conditions spécifiques d'installation.

Maximum number of luminaires per power supply. (220÷240 V). These data must be checked taking into account the specific installation conditions.

Acc. F990B22A000 **10

**La tension entre les extrémités du système dépend du nombre de luminaires connectés en série. Veuillez vous en tenir à la norme CEI 64-8.

**The voltage at the end of the system depends on the number of fixtures connected in series, please comply with CEI 64-8 standards.

Aimer 3 Constant Voltage

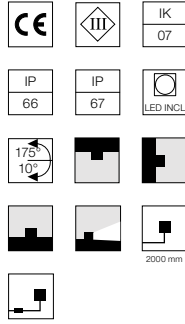
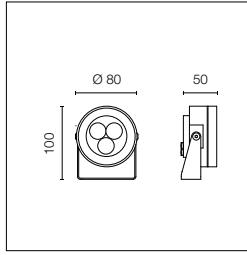

Source LED incluse. Source d'alimentation électrique à distance 24V dc ON/OFF, à commander séparément. Connexion en parallèle. Équipé d'un câble sortant de 2000 mm en néoprène, et d'un kit avec des connecteurs sertissables et des gaines thermorétractables adhésives qui garantissent l'étanchéité de la connexion. Équerre de maintien incluse. Verre transparent extra-clair. Clou métallique pour l'installation au sol, à commander séparément.

LED source included. Remote electrical power supply 24V dc ON/OFF to be ordered separately. Parallel connection. Equipped with a 2000 mm protruding section of neoprene cable and a kit with crimpable connectors and adhesive heat-shrinkable sleeves that guarantee the tightness of the connection. Fixing bracket included. Extraclear transparent glass. The metal nail for ground installation needs to be ordered separately.

2200K disponible sur demande.

2200K available on request.

Optic Spot 10°

Power Led: 4,5W - 431 lm ≠ OUTPUT 359 lm - 2700K/CRI 80 - 24Vdc / 4,5W - 466 lm ≠ OUTPUT 389 lm - 3000K/CRI 80 - 24Vdc / 4,5W - 484 lm ≠ OUTPUT 404 lm - 4000K/CRI 80 - 24Vdc

2700K

○ FA105562201	231,00 €
● FA105562206	231,00 €
● FA105562212	231,00 €
● FA105562218	231,00 €
● FA105562230	231,00 €
● FA105562233	231,00 €
● FA105562270	231,00 €

3000K

○ FA105561201	231,00 €
● FA105561206	231,00 €
● FA105561212	231,00 €
● FA105561218	231,00 €
● FA105561230	231,00 €
● FA105561233	231,00 €
● FA105561270	231,00 €

4000K

○ FA1051721201	231,00 €
● FA1051721206	231,00 €
● FA1051721212	231,00 €
● FA1051721218	231,00 €
● FA1051721230	231,00 €
● FA1051721233	231,00 €
● FA1051721270	231,00 €

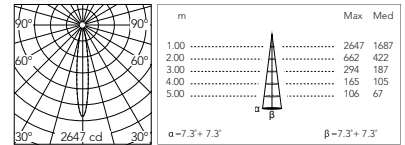

@ 3000K

Optic Medium 30°

Power Led: 4,5W - 431 lm ≠ OUTPUT 364 lm - 2700K/CRI 80 - 24Vdc / 4,5W - 466 lm ≠ OUTPUT 395 lm - 3000K/CRI 80 - 24Vdc / 4,5W - 484 lm ≠ OUTPUT 410 lm - 4000K/CRI 80 - 24Vdc

2700K

○ FA105562101	231,00 €
● FA105562106	231,00 €
● FA105562112	231,00 €
● FA105562118	231,00 €
● FA105562130	231,00 €
● FA105562133	231,00 €
● FA105562170	231,00 €

3000K

○ FA105561101	231,00 €
● FA105561106	231,00 €
● FA105561112	231,00 €
● FA105561118	231,00 €
● FA105561130	231,00 €
● FA105561133	231,00 €
● FA105561170	231,00 €

4000K

○ FA1051721101	231,00 €
● FA1051721106	231,00 €
● FA1051721112	231,00 €
● FA1051721118	231,00 €
● FA1051721130	231,00 €
● FA1051721133	231,00 €
● FA1051721170	231,00 €

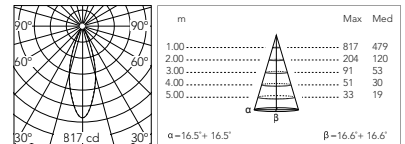

@ 3000K

Optic Flood 50°

Power Led: 4,5W - 431 lm ≠ OUTPUT 329 lm - 2700K/CRI 80 - 24Vdc / 4,5W - 466 lm ≠ OUTPUT 357 lm - 3000K/CRI 80 - 24Vdc / 4,5W - 484 lm ≠ OUTPUT 371 lm - 4000K/CRI 80 - 24Vdc

2700K

○ FA105562001	231,00 €
● FA105562006	231,00 €
● FA105562012	231,00 €
● FA105562018	231,00 €
● FA105562030	231,00 €
● FA105562033	231,00 €
● FA105562070	231,00 €

3000K

○ FA105560001	231,00 €
● FA105560006	231,00 €
● FA105560012	231,00 €
● FA105560018	231,00 €
● FA105560030	231,00 €
● FA105560033	231,00 €
● FA105560070	231,00 €

4000K

○ FA1051720001	231,00 €
● FA1051720006	231,00 €
● FA1051720012	231,00 €
● FA1051720018	231,00 €
● FA1051720030	231,00 €
● FA1051720033	231,00 €
● FA1051720070	231,00 €

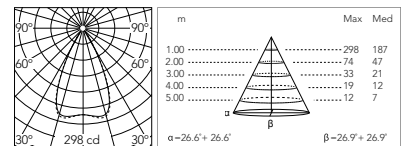

@ 3000K

* Nombre maximum de luminaires par source d'alimentation / Maximum number of luminaires per power supply.

Nombre maximum de luminaires par source d'alimentation (220÷240 V). Ces données doivent être vérifiées en prenant en compte les conditions spécifiques d'installation.

Maximum number of luminaires per power supply. (220÷240 V). These data must be checked taking into account the specific installation conditions.

Acc. RF25754	1	Acc. RF25752	3
Acc. RF25748	1	Acc. F990B28A000	7
Acc. RF25747	2	Acc. F990B27A000	14
Acc. RF25757	2		

Aimer 3 Constant Current

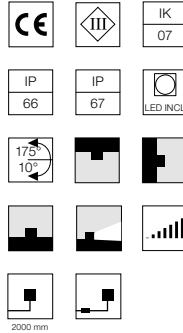
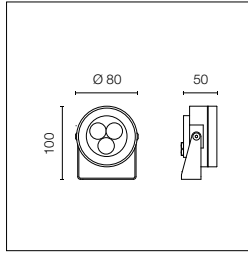

Source LED incluse. Source d'alimentation électrique à distance 350/500 mA ON/OFF et intensité réglable entre 1 y 10V o DALI, à commander séparément. Connexion en série. Équipé d'un câble sortant de 2000 mm en néoprène, et d'un kit avec des connecteurs sertissables et des gaines thermorétractables adhésives qui garantissent l'étanchéité de la connexion. Verre transparent extra-clair. Clou métallique pour l'installation au sol, à commander séparément.

LED source included. Remote power supply 350/500 mA ON/OFF and dimmable 1-10V or DALI. Must be ordered separately. Serial connection. Equipped with a 2000 mm protruding section of neoprene cable and a kit with crimpable connectors and adhesive heat-shrinkable sleeves that guarantee the tightness of the connection. Extraclear transparent glass. The metal nail for ground installation needs to be ordered separately.

2200K disponible sur demande.

2200K available on request.

Optic Spot 10°

Power Led: 3,3W@350mA - 331@350mA lm ≠ OUTPUT 270@350mA lm / 5,1W@500mA - 431@500mA lm ≠ OUTPUT 359@500mA lm - 2700K/CRI 80
 3,3W@350mA - 359@350mA lm ≠ OUTPUT 293@350mA lm - 5,1W@500mA - 466@500mA lm ≠ OUTPUT 389@500mA lm - 3000K/CRI 80
 3,3W@350mA - 373@350mA lm ≠ OUTPUT 304@350mA lm - 5,1W@500mA - 484@500mA lm ≠ OUTPUT 404@500mA lm - 4000K/CRI 80

2700K

- FA1051072201 219,00 €
- FA1051072206 219,00 €
- FA1051072212 219,00 €
- FA1051072218 219,00 €
- FA1051072230 219,00 €
- FA1051072233 219,00 €
- FA1051072270 219,00 €

3000K

- FA1051071201 219,00 €
- FA1051071206 219,00 €
- FA1051071212 219,00 €
- FA1051071218 219,00 €
- FA1051071230 219,00 €
- FA1051071233 219,00 €
- FA1051071270 219,00 €

4000K

- FA1051901201 219,00 €
- FA1051901206 219,00 €
- FA1051901212 219,00 €
- FA1051901218 219,00 €
- FA1051901230 219,00 €
- FA1051901233 219,00 €
- FA1051901270 219,00 €

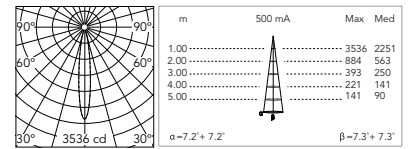

@ 3000K

Optic Medium 30°

Power Led: 3,3W@350mA - 331@350mA lm ≠ OUTPUT 274@350mA lm / 5,1W@500mA - 431@500mA lm ≠ OUTPUT 364@500mA lm - 2700K/CRI 80
 3,3W@350mA - 359@350mA lm ≠ OUTPUT 297@350mA lm - 5,1W@500mA - 466@500mA lm ≠ OUTPUT 395@500mA lm - 3000K/CRI 80
 3,3W@350mA - 373@350mA lm ≠ OUTPUT 308@350mA lm - 5,1W@500mA - 484@500mA lm ≠ OUTPUT 410@500mA lm - 4000K/CRI 80

2700K

- FA1051072101 219,00 €
- FA1051072106 219,00 €
- FA1051072112 219,00 €
- FA1051072118 219,00 €
- FA1051072130 219,00 €
- FA1051072133 219,00 €
- FA1051072170 219,00 €

3000K

- FA1051071101 219,00 €
- FA1051071106 219,00 €
- FA1051071112 219,00 €
- FA1051071118 219,00 €
- FA1051071130 219,00 €
- FA1051071133 219,00 €
- FA1051071170 219,00 €

4000K

- FA1051901101 219,00 €
- FA1051901106 219,00 €
- FA1051901112 219,00 €
- FA1051901118 219,00 €
- FA1051901130 219,00 €
- FA1051901133 219,00 €
- FA1051901170 219,00 €

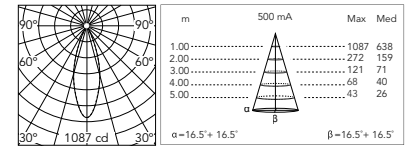

@ 3000K

Optic Flood 50°

Power Led: 3,3W@350mA - 331@350mA lm ≠ OUTPUT 247@350mA lm / 5,1W@500mA - 431@500mA lm ≠ OUTPUT 329@500mA lm - 2700K/CRI 80
 3,3W@350mA - 359@350mA lm ≠ OUTPUT 267@350mA lm - 5,1W@500mA - 466@500mA lm ≠ OUTPUT 357@500mA lm - 3000K/CRI 80
 3,3W@350mA - 373@350mA lm ≠ OUTPUT 278@350mA lm - 5,1W@500mA - 484@500mA lm ≠ OUTPUT 371@500mA lm - 4000K/CRI 80

2700K

- FA1051072001 219,00 €
- FA1051072006 219,00 €
- FA1051072012 219,00 €
- FA1051072018 219,00 €
- FA1051072030 219,00 €
- FA1051072033 219,00 €
- FA1051072070 219,00 €

3000K

- FA1051070001 219,00 €
- FA1051070006 219,00 €
- FA1051070012 219,00 €
- FA1051070018 219,00 €
- FA1051070030 219,00 €
- FA1051070033 219,00 €
- FA1051070070 219,00 €

4000K

- FA1051900001 219,00 €
- FA1051900006 219,00 €
- FA1051900012 219,00 €
- FA1051900018 219,00 €
- FA1051900030 219,00 €
- FA1051900033 219,00 €
- FA1051900070 219,00 €

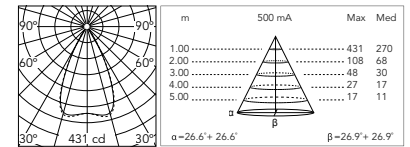

@ 3000K

* Nombre maximum de luminaires par source d'alimentation / Maximum number of luminaires per power supply.

Nombre maximum de luminaires par source d'alimentation (220-240 V). Ces données doivent être vérifiées en prenant en compte les conditions spécifiques d'installation.

Maximum number of luminaires per power supply. (220-240 V). These data must be checked taking into account the specific installation conditions.

Acc. RF25754	2
Acc. RF25748	2
Acc. FA68	3
Acc. FA129	**5
Acc. FA184	**5

Acc. FA135	**2
Acc. FA218	**2
Acc. FA238.A	**3
Acc. FA239.A	**3

**La tension entre les extrémités du système dépend du nombre de luminaires connectés en série. Veuillez vous en tenir à la norme CEI 64-8.

**The voltage at the end of the system depends on the number of fixtures connected in series, please comply with CEI 64-8 standards.

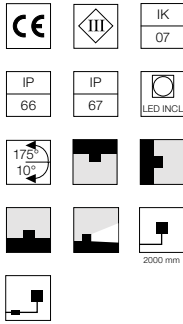
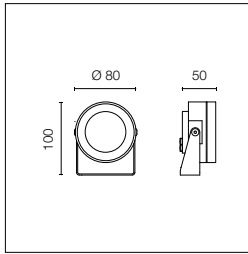

Source LED RGB incluse.
 Source d'alimentation électrique à distance avec interface DMX 3chx350mA à commander séparément. Connexion en série. Équipé d'un câble sortant de 2000 mm en néoprène, et d'un kit avec des connecteurs sertissables et des gaines thermorétractables adhésives qui garantissent l'étanchéité de la connexion.
 Verre sérigraphié transparent.
 Clou métallique pour l'installation au sol, à commander séparément.

RGB LED source included.
 Remote electrical power supply with DMX 3chx350mA interface to be ordered separately. Serial connection. Equipped with a 2000 mm protruding section of neoprene cable and a kit with crimpable connectors and adhesive heat-shrinkable sleeves that guarantee the tightness of the connection.
 Transparent screen-printed glass.
 The metal nail for ground installation needs to be ordered separately.

Schéma électrique et installation système RGB.

10 luminaires Aimer 3 RGB maximum pour chaque code F990B22A000.

Voir schéma électrique n.5 Page 832.

Wiring diagram and installation scheme RGB.

Max 10 luminaires Aimer 3 RGB for each code F990B22A000.

See Wiring Diagram n.5 Page 832.

Optic Spot 10°

Power Led: 3, 4W - 3CH x 350mA

RGB

- FA1051741201 219,00 €
- FA1051741206 219,00 €
- FA1051741212 219,00 €
- FA1051741218 219,00 €
- FA1051741230 219,00 €
- FA1051741233 219,00 €
- FA1051741270 219,00 €

Optic Medium 35°

Power Led: 3, 4W - 3CH x 350mA

RGB

- FA1051740001 219,00 €
- FA1051740006 219,00 €
- FA1051740012 219,00 €
- FA1051740018 219,00 €
- FA1051740030 219,00 €
- FA1051740033 219,00 €
- FA1051740070 219,00 €

Photometric data on request.

* Nombre maximum de luminaires par source d'alimentation / Maximum number of luminaires per power supply.

Nombre maximum de luminaires par source d'alimentation (220÷240 V). Ces données doivent être vérifiées en prenant en compte les conditions spécifiques d'installation.

Maximum number of luminaires per power supply. (220÷240 V). These data must be checked taking into account the specific installation conditions.

Acc. F990B22A000 **10

**La tension entre les extrémités du système dépend du nombre de luminaires connectés en série. Veuillez vous en tenir à la norme CEI 64-8.

**The voltage at the end of the system depends on the number of fixtures connected in series, please comply with CEI 64-8 standards.

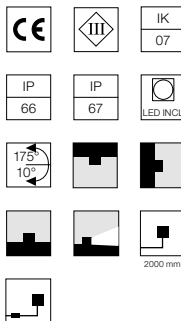
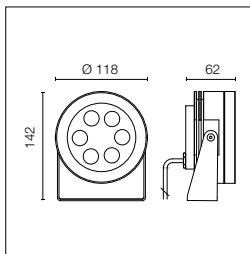

Source LED incluse. Source d'alimentation électrique à distance 24V dc ON/OFF, à commander séparément. Connexion en parallèle. Équipé d'un câble sortant de 2000 mm en néoprène, et d'un kit avec des connecteurs sertissables et des gaines thermorétractables adhésives qui garantissent l'étanchéité de la connexion. Équerre de maintien incluse. Verre transparent extra-clair. Clou métallique pour l'installation au sol, à commander séparément.

LED source included. Remote electrical power supply 24V dc ON/OFF to be ordered separately. Parallel connection. Equipped with a 2000 mm protruding section of neoprene cable and a kit with crimpable connectors and adhesive heat-shrinkable sleeves that guarantee the tightness of the connection. Fixing bracket included. Extraclear transparent glass. The metal nail for ground installation needs to be ordered separately.

2200K disponible sur demande.

2200K available on request.

Optic Spot 8°

Power Led: 10W - 776 lm ≠ OUTPUT 498 lm - 2700K/CRI 80 - 24Vdc / 10W - 834 lm ≠ OUTPUT 535 lm - 3000K/CRI 80 - 24Vdc / 10W - 889 lm ≠ OUTPUT 570 lm - 4000K/CRI 80 - 24Vdc

2700K		3000K		4000K	
○ FA1052552201	461,00 €	○ FA1052551201	461,00 €	○ FA1052541201	461,00 €
● FA1052552206	461,00 €	● FA1052551206	461,00 €	● FA1052541206	461,00 €
● FA1052552212	461,00 €	● FA1052551212	461,00 €	● FA1052541212	461,00 €
● FA1052552218	461,00 €	● FA1052551218	461,00 €	● FA1052541218	461,00 €
● FA1052552230	461,00 €	● FA1052551230	461,00 €	● FA1052541230	461,00 €
● FA1052552233	461,00 €	● FA1052551233	461,00 €	● FA1052541233	461,00 €
● FA1052552270	461,00 €	● FA1052551270	461,00 €	● FA1052541270	461,00 €

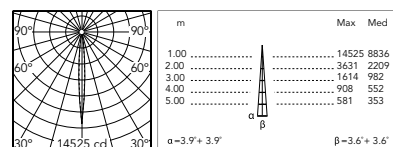

@ 4000K

Optic Medium 26°

Power Led: 10W - 776 lm ≠ OUTPUT 486 lm - 2700K/CRI 80 - 24Vdc / 10W - 834 lm ≠ OUTPUT 523 lm - 3000K/CRI 80 - 24Vdc / 10W - 889 lm ≠ OUTPUT 558 lm - 4000K/CRI 80 - 24Vdc

2700K		3000K		4000K	
○ FA1052552001	461,00 €	○ FA1052550001	461,00 €	○ FA1052540001	461,00 €
● FA1052552006	461,00 €	● FA1052550006	461,00 €	● FA1052540006	461,00 €
● FA1052552012	461,00 €	● FA1052550012	461,00 €	● FA1052540012	461,00 €
● FA1052552018	461,00 €	● FA1052550018	461,00 €	● FA1052540018	461,00 €
● FA1052552030	461,00 €	● FA1052550030	461,00 €	● FA1052540030	461,00 €
● FA1052552033	461,00 €	● FA1052550033	461,00 €	● FA1052540033	461,00 €
● FA1052552070	461,00 €	● FA1052550070	461,00 €	● FA1052540070	461,00 €

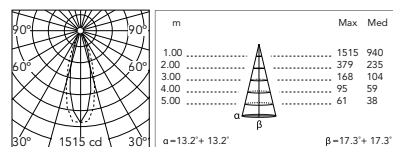

@ 4000K

* Nombre maximum de luminaires par source d'alimentation / Maximum number of luminaires per power supply.

Nombre maximum de luminaires par source d'alimentation (220÷240 V). Ces données doivent être vérifiées en prenant en compte les conditions spécifiques d'installation.	Maximum number of luminaires per power supply. (220÷240 V). These data must be checked taking into account the specific installation conditions.	Acc. RF25752	1
		Acc. F990B28A000	2
		Acc. F990B27A000	5

Aimer 5 Constant Voltage

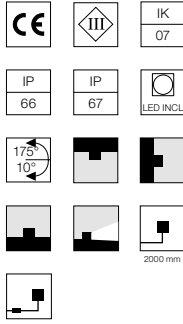
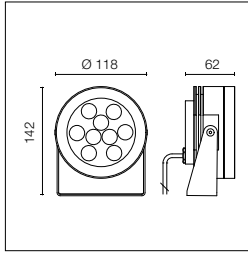

Source LED incluse. Source d'alimentation électrique à distance 24V dc ON/OFF, à commander séparément. Connexion en parallèle. Équipé d'un câble sortant de 2000 mm en néoprène, et d'un kit avec des connecteurs sertissables et des gaines thermorétractables adhésives qui garantissent l'étanchéité de la connexion. Équerre de maintien incluse. Verre transparent extra-clair. Clou métallique pour l'installation au sol, à commander séparément.

LED source included. Remote electrical power supply 24V dc ON/OFF to be ordered separately. Parallel connection. Equipped with a 2000 mm protruding section of neoprene cable and a kit with crimpable connectors and adhesive heat-shrinkable sleeves that guarantee the tightness of the connection. Fixing bracket included. Extraclear transparent glass. The metal nail for ground installation needs to be ordered separately.

2200K disponible sur demande.

2200K available on request.

Optic Spot 8°

Power Led: 14W - 1164 lm ≠ OUTPUT 747 lm - 2700K/CRI 80 - 24Vdc / 14W - 1252 lm ≠ OUTPUT 803 lm - 3000K/CRI 80 - 24Vdc / 14W - 1333 lm ≠ OUTPUT 855 lm - 4000K/CRI 80 - 24Vdc

2700K

○ FA1052522201	551,00 €
● FA1052522206	551,00 €
● FA1052522212	551,00 €
● FA1052522218	551,00 €
● FA1052522230	551,00 €
● FA1052522233	551,00 €
● FA1052522270	551,00 €

3000K

○ FA1052521201	551,00 €
● FA1052521206	551,00 €
● FA1052521212	551,00 €
● FA1052521218	551,00 €
● FA1052521230	551,00 €
● FA1052521233	551,00 €
● FA1052521270	551,00 €

4000K

○ FA1052511201	551,00 €
● FA1052511206	551,00 €
● FA1052511212	551,00 €
● FA1052511218	551,00 €
● FA1052511230	551,00 €
● FA1052511233	551,00 €
● FA1052511270	551,00 €

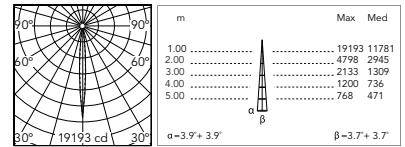

@ 3000K

Optic Medium 28°

Power Led: 14W - 1164 lm ≠ OUTPUT 730 lm - 2700K/CRI 80 - 24Vdc / 14W - 1252 lm ≠ OUTPUT 785 lm - 3000K/CRI 80 - 24Vdc / 14W - 1333 lm ≠ OUTPUT 836 lm - 4000K/CRI 80 - 24Vdc

2700K

○ FA1052522001	551,00 €
● FA1052522006	551,00 €
● FA1052522012	551,00 €
● FA1052522018	551,00 €
● FA1052522030	551,00 €
● FA1052522033	551,00 €
● FA1052522070	551,00 €

3000K

○ FA1052520001	551,00 €
● FA1052520006	551,00 €
● FA1052520012	551,00 €
● FA1052520018	551,00 €
● FA1052520030	551,00 €
● FA1052520033	551,00 €
● FA1052520070	551,00 €

4000K

○ FA1052510001	551,00 €
● FA1052510006	551,00 €
● FA1052510012	551,00 €
● FA1052510018	551,00 €
● FA1052510030	551,00 €
● FA1052510033	551,00 €
● FA1052510070	551,00 €

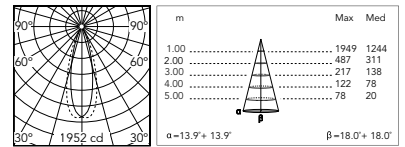

@ 3000K

* Nombre maximum de luminaires par source d'alimentation / Maximum number of luminaires per power supply.

Nombre maximum de luminaires par source d'alimentation (220÷240 V). Ces données doivent être vérifiées en prenant en compte les conditions spécifiques d'installation.	Maximum number of luminaires per power supply. (220÷240 V). These data must be checked taking into account the specific installation conditions.	Acc.F990B28A000 1	Acc.F990B27A000 3
--	--	----------------------	----------------------

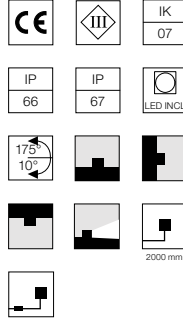
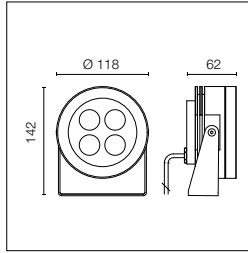

Source LED RGB incluse.
 Source d'alimentation électrique à distance avec interface DMX 3chx350mA à commander séparément. Connexion en série. Équipé d'un câble sortant de 2000 mm en néoprène, et d'un kit avec des connecteurs sertissables et des gaines thermorétractables adhésives qui garantissent l'étanchéité de la connexion.
 Verre sérigraphié transparent.
 Clou métallique pour l'installation au sol, à commander séparément.

RGB LED source included.
 Remote electrical power supply with DMX 3chx350mA interface to be ordered separately. Serial connection. Equipped with a 2000 mm protruding section of neoprene cable and a kit with crimpable connectors and adhesive heat-shrinkable sleeves that guarantee the tightness of the connection.
 Transparent screen-printed glass.
 The metal nail for ground installation needs to be ordered separately.

Optic Spot 10°

RGB Power Led: 13,6W - 3CH x 350mA

RGB

- FA1052561201 461,00 €
- FA1052561206 461,00 €
- FA1052561212 461,00 €
- FA1052561218 461,00 €
- FA1052561230 461,00 €
- FA1052561233 461,00 €
- FA1052561270 461,00 €

Schéma électrique et installation système RGB.

2 luminaires Aimer 5 RGB maximum pour chaque code F990B22A000.

Voir schéma électrique n.5 Page 832.

Wiring diagram and installation scheme RGB.

Max 2 luminaires Aimer 5 RGB for each code F990B22A000.

See Wiring Diagram n.5 Page 832.

Optic Medium 35°

RGB Power Led: 13,6W - 3CH x 350mA

RGB

- FA1052560001 461,00 €
- FA1052560006 461,00 €
- FA1052560012 461,00 €
- FA1052560018 461,00 €
- FA1052560030 461,00 €
- FA1052560033 461,00 €
- FA1052560070 461,00 €

Photometric data on request.

* Nombre maximum de luminaires par source d'alimentation / Maximum number of luminaires per power supply.

Nombre maximum de luminaires par source d'alimentation (220÷240 V). Ces données doivent être vérifiées en prenant en compte les conditions spécifiques d'installation.

Maximum number of luminaires per power supply. (220÷240 V). These data must be checked taking into account the specific installation conditions.

Acc. F990B22A000

**La tension entre les extrémités du système dépend du nombre de luminaires connectés en série. Veuillez vous en tenir à la norme CEI 64-8.

**The voltage at the end of the system depends on the number of fixtures connected in series, please comply with CEI 64-8 standards.







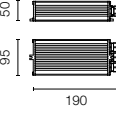



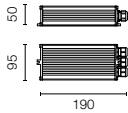

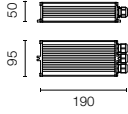

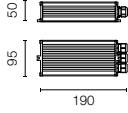
Aimer: Accessoires / Accessories

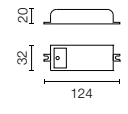
Visière Aimer 1.	Visor Aimer 1.	Aimer 1 FA5230	36,00 €		
Visière Aimer 3.	Visor Aimer 3.	Aimer 3 FA5130	40,00 €		
Pique pour la fixation au sol.	Ground spike.	Aimer 1 / 3 / 4 / 5 FA136	34,00 €		
Système de jonction IP68 H2O Stop anti-condensation à 3/4 voies 4 pôles. (Ø5,5÷12mm câble).	3/4 way terminal block 4 poles IP68 H2O Stop. (Ø5,5÷12mm cable).	Aimer 3 / 4 / 5 F990C010000	60,00 €		
Système de jonction IP68 H2O Stop anti-condensation à 2 voies 4 pôles. (Ø5,5÷12mm câble).	2 way terminal block 4 poles IP68 H2O Stop. (Ø5,5÷12mm cable).	Aimer 3 / 4 / 5 F990C00A000	33,00 €		

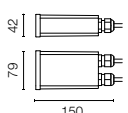
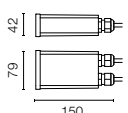

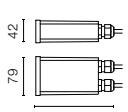

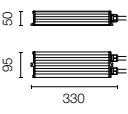

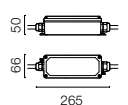



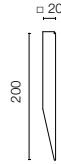

Aimer: Appareillages électriques / Drivers

Source d'alimentation avec fonction dual Vout 24Vdc : 8W/100÷240V Iout 350ma: 6x1W/100÷240V IP20 Classe II Selv Eq.	Power supply dual function Vout 24Vdc: 8W/100÷240V Iout 350ma: 6x1W/100÷240V IP20 Class II Selv Eq.	Aimer 1 / 3 *RF25754	36,00 €		
Équipement d'alimentation 24V 8W / 110-240V IP65 Classe II selv.	Power supply 24V 8W / 110-240V IP65 Class II selv.	Aimer 1 / 3 *RF25748	63,00 €		
Équipement d'alimentation 10 x 1W/ 100÷265V - Iout 350mA (7x1W/110V) IP40 Classe II selv. Eq.	Power supply 10 x 1W/ 100÷265V - Iout 350mA (7x1W/110V) IP40 Class II Selv Eq.	Aimer 1 / 3 *FA68	49,00 €		
Équipement d'alimentation 16 x 1W/ 110÷240V - Iout 350mA (12x1W@110V) IP20 Classe II selv. Eq.	Power supply 16 x 1W/ 110÷240V - Iout 350mA (12x1W@110V) IP20 Class II Selv Eq.	Aimer 1 / 3 *FA129 	96,00 €		
Équipement d'alimentation 16 x 1W/ 110÷240V - Iout 350mA (12x1W@110V) IP67 Classe II selv.	Power supply 16 x 1W/ 110÷240V - Iout 350mA (12x1W@110V) IP67 Class II Selv.	Aimer 1 / 3 *FA184 	155,00 €		
Équipement d'alimentation 13 x 2W/ 110÷240V - Iout 500mA (7x2W@110V) IP20 Classe II selv. Eq.	Power supply 13 x 2W/ 110÷240V - Iout 500mA (7x2W@110V) IP20 Class II Selv. Eq.	Aimer 1 / 3 *FA135 	96,00 €		

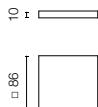
Aimer: Appareillages électriques / Drivers

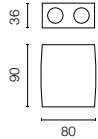
Équipement d'alimentation 13 x 2W/ 110÷240V - Iout 500mA (7x2W@110V) IP67 Classe II selv.	Power supply 13 x 2W/ 110÷240V - Iout 500mA (7x2W@110V) IP67 Class II Selv.	Aimer 1 / 3 *FA218	155,00 €		
		Dimmable Push-Dim Or 1-10V See Wiring Diagram n.3. Page Page 830			
Équipement d'alimentation 18W/ 110÷240V - Iout 350mA (15W@110V) IP67 Classe II selv. C	Power supply 18W/ 110÷240V - Iout 350mA (15W@110V) IP67 Class II Selv. C.	Aimer 1 / 3 *FA238.A	159,00 €		
		Dimmable DALI See Wiring Diagram n.3. Page Page 830			
Équipement d'alimentation 24W/ 110÷240V - Iout 500mA (15W@110V) IP67 Classe II selv.	Power supply 24W/ 110÷240V - Iout 500mA (15W@110V) IP67 Class II Selv.	Aimer 1 / 3 *FA239.A	159,00 €		
		Dimmable DALI See Wiring Diagram n.3. Page Page 830			
Équipement d'alimentation 24V 10W / 110-240V IP20 Classe II selv.	Power supply 24V 10W /110- 240V IP20 Class II selv.	Aimer 3 *RF25747	48,00 €		
Équipement d'alimentation 24V 10W / 110-240V IP67 Classe II selv.	Power supply 24V 10W / 110-240V IP67 Class II selv.	Aimer 3 *RF25757	86,00 €		
Équipement d'alimentation pour installation à distance 24Vdc 20W / 220-240V IP67 Classe II selv.	Power supply for remote installation 24Vdc 20W / 220- 240V IP67 Class II selv.	Aimer 3 / 4 / 5 *RF25752	133,00 €		
Alimentation 24Vdc 35W / 120-270V IP67 Class II selv.	Power supply 24Vdc 35W / 120-270V IP67 Class II selv.	F990B23AZ00	180,00 €		
Équipement d'alimentation pour installation à distance 24Vdc 50W / 120-240V IP67 Classe II selv.	Power supply for remote installation 24Vdc 50W / 120- 240V IP67 Class II selv.	Aimer 3 / 4 / 5 *F990B28A000	251,00 €		
Équipement d'alimentation pour installation à distance 24Vdc 70W / 220-240V IP67 Classe II selv.	Power supply for remote installation 24Vdc 70W / 220- 240V IP67 Class II selv.	Aimer 3 / 4 / 5 *F990B27A000	212,00 €		

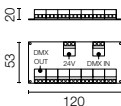
Aimer RGB: Accessoires / Accessories

Visière Aimer 1.	Visor Aimer 1.	Aimer 1 RGB FA5230	36,00 €		
Visière Aimer 3.	Visor Martina.	Aimer 3 RGB FA5130	40,00 €		
Pique pour la fixation au sol.	Ground spike.	Aimer 1 / 3 / 4 / 5 RGB FA136	34,00 €		
Contrôleur DMX pour boîtes encastrables. (60 mm d'entraxe)	DMX controller; dimmer switch for recessed box (60mm hole centres).	F990B10A000	1.006,00 €		
Contrôleur DMX. Interface stand/alone PC.	DMX controller; stand-alone/PC interface.	F990B11A000	1.306,00 €		
DMX splitter 512- dispositif électronique pour régénérer le signal dmx monodirectionnel. 1 entrée et 7 sorties, 12-24 Vdc. Source d'alimentation non incluse.	DMX splitter 512 - electronic device to regenerate the monodirectional DMX signal 1 Input and 7 output, 12-24Vdc.	F990B13A000	227,00 €		
Câble DMX blindé à impédance constante 110 Ohm.	DMX cable - shielded twisted pair with 110 Ohm constant impedance.	F990B12A000	19,00 €		

Aimer RGB: Appareillages électriques / Drivers

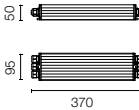
Source d'alimentation avec interface dmx pour luminaires RGB 36W/220÷240V-3CH x 350mA (3CH x 10 x 1W) réglage préalable DMX IP67 Classe I Selv Eq.	Power supply with DMX interface for RGB fixtures 36W/220÷240v-3CH x 350mA (3CH x 10 x 1W) DMX control allowed IP67 Class I Selv Eq.	*F990B22A000	246,00 €		
--	---	--------------	----------	---	---

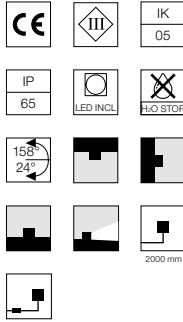
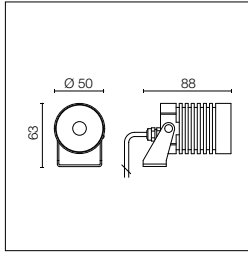

Source LED incluse. Source d'alimentation électrique à distance 24v dc ON/OFF, à commander séparément. Équipé d'un câble sortant de 2000 mm en néoprène, et d'un kit avec des connecteurs sertissables et des gaines thermorétractables adhésives qui garantissent l'étanchéité de la connexion. Équerre de maintien incluse. Verre transparent extra-clair. Clou métallique pour l'installation au sol, à commander séparément. Version à intensité réglable disponible sur demande.

LED source included. Remote electrical power supply 24V dc ON/OFF to be ordered separately. Equipped with a 2000 mm protruding section of neoprene cable and a kit with crimpable connectors and adhesive heat-shrinkable sleeves that guarantee the tightness of the connection. Fixing bracket included. Extraclear transparent glass. The metal nail for ground installation needs to be ordered separately. Dimmable version available upon request.

2200K disponible sur demande.

2200K available on request.

Optic Spot 10°

Power Led: 3,4W - 199 lm ≠ OUTPUT 138 lm - 2700K/CRI 80 - 24Vdc / 3,4W - 215 lm ≠ OUTPUT 149 lm - 3000K/CRI 80 - 24Vdc / 3,4W - 224 lm ≠ OUTPUT 155 lm - 4000K/CRI 80 - 24Vdc

2700K

○ FA51308001	198,00 €
● FA51308006	198,00 €
● FA51308012	198,00 €
● FA51308018	198,00 €
● FA51308030	198,00 €
● FA51308033	198,00 €

3000K

○ FA51300301	198,00 €
● FA51300306	198,00 €
● FA51300312	198,00 €
● FA51300318	198,00 €
● FA51300330	198,00 €
● FA51300333	198,00 €

4000K

○ FA51300201	198,00 €
● FA51300206	198,00 €
● FA51300212	198,00 €
● FA51300218	198,00 €
● FA51300230	198,00 €
● FA51300233	198,00 €

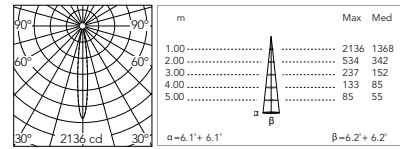

@3000K

Optic Medium 30°

Power Led: 3,4W - 199 lm ≠ OUTPUT 121 lm - 2700K/CRI 80 - 24Vdc / 3,4W - 215 lm ≠ OUTPUT 131 lm - 3000K/CRI 80 - 24Vdc / 3,4W - 224 lm ≠ OUTPUT 136 lm - 4000K/CRI 80 - 24Vdc

2700K

○ FA51308201	198,00 €
● FA51308206	198,00 €
● FA51308212	198,00 €
● FA51308218	198,00 €
● FA51308230	198,00 €
● FA51308233	198,00 €

3000K

○ FA51301301	198,00 €
● FA51301306	198,00 €
● FA51301312	198,00 €
● FA51301318	198,00 €
● FA51301330	198,00 €
● FA51301333	198,00 €

4000K

○ FA51301201	198,00 €
● FA51301206	198,00 €
● FA51301212	198,00 €
● FA51301218	198,00 €
● FA51301230	198,00 €
● FA51301233	198,00 €

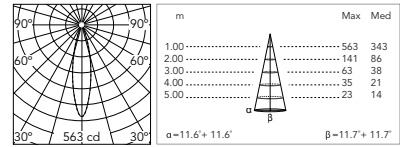

@3000K

* Nombre maximum de luminaires par source d'alimentation / Maximum number of luminaires per power supply.

Nombre maximum de luminaires par source d'alimentation (220÷240 V). Ces données doivent être vérifiées en prenant en compte les conditions spécifiques d'installation.	Maximum number of luminaires per power supply. (220÷240 V). These data must be checked taking into account the specific installation conditions.	Acc. RF25754	1	Acc. RF25752	3
		Acc. RF25748	1	Acc.F990B28A000	9
		Acc. RF25747	2	Acc. F990B27A000	17
		Acc. RF25757	2		

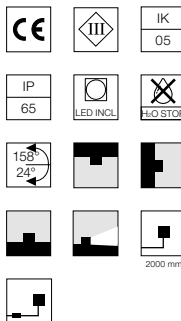
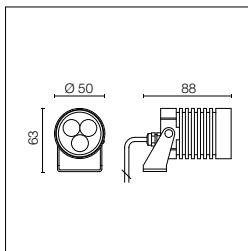

Source LED incluse. Source d'alimentation électrique à distance 24v dc ON/OFF, à commander séparément. Équipé d'un câble sortant de 2000 mm en néoprène, et d'un kit avec des connecteurs sertissables et des gaines thermorétractables adhésives qui garantissent l'étanchéité de la connexion. Équerre de maintien incluse. Verre transparent extra-clair. Clou métallique pour l'installation au sol, à commander séparément. Version à intensité réglable disponible sur demande.

LED source included. Remote electrical power supply 24V dc ON/OFF to be ordered separately. Equipped with a 2000 mm protruding section of neoprene cable and a kit with crimpable connectors and adhesive heat-shrinkable sleeves that guarantee the tightness of the connection. Fixing bracket included. Extraclear transparent glass. The metal nail for ground installation needs to be ordered separately. Dimmable version available upon request.

2200K disponible sur demande.

2200K available on request.

Optic Spot 10°

Power Led: 4,5W - 331 lm ≠ OUTPUT 246 lm - 2700K/CRI 80 - 24Vdc / 4,5W - 359 lm ≠ OUTPUT 267 lm - 3000K/CRI 80 - 24Vdc / 4,5W - 373 lm ≠ OUTPUT 277 lm - 4000K/CRI 80 - 24Vdc

2700K		3000K		4000K	
○ FA51308401	215,00 €	○ FA51302301	215,00 €	○ FA51302201	215,00 €
● FA51308406	215,00 €	● FA51302306	215,00 €	● FA51302206	215,00 €
● FA51308412	215,00 €	● FA51302312	215,00 €	● FA51302212	215,00 €
● FA51308418	215,00 €	● FA51302318	215,00 €	● FA51302218	215,00 €
● FA51308430	215,00 €	● FA51302330	215,00 €	● FA51302230	215,00 €
● FA51308433	215,00 €	● FA51302333	215,00 €	● FA51302233	215,00 €

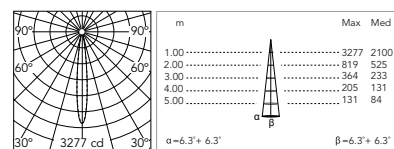

@3000K

Optic Medium 30°

Power Led: 4,5W - 331 lm ≠ OUTPUT 218 lm - 2700K/CRI 80 - 24Vdc / 4,5W - 359 lm ≠ OUTPUT 236 lm - 3000K/CRI 80 - 24Vdc / 4,5W - 373 lm ≠ OUTPUT 245 lm - 4000K/CRI 80 - 24Vdc

2700K		3000K		4000K	
○ FA51308601	215,00 €	○ FA51303301	215,00 €	○ FA51303201	215,00 €
● FA51308606	215,00 €	● FA51303306	215,00 €	● FA51303206	215,00 €
● FA51308612	215,00 €	● FA51303312	215,00 €	● FA51303212	215,00 €
● FA51308618	215,00 €	● FA51303318	215,00 €	● FA51303218	215,00 €
● FA51308630	215,00 €	● FA51303330	215,00 €	● FA51303230	215,00 €
● FA51308633	215,00 €	● FA51303333	215,00 €	● FA51303233	215,00 €

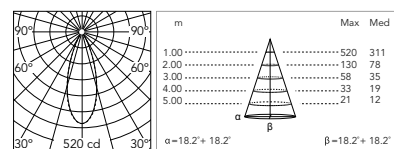

@3000K

* Nombre maximum de luminaires par source d'alimentation / Maximum number of luminaires per power supply.

Nombre maximum de luminaires par source d'alimentation (220-240 V). Ces données doivent être vérifiées en prenant en compte les conditions spécifiques d'installation.	Maximum number of luminaires per power supply. (220-240 V). These data must be checked taking into account the specific installation conditions.	Acc. RF25754	1	Acc. RF25757	2
		Acc. RF25748	1	Acc.F990B28A000	9
		Acc. RF25747	2	Acc. F990B27A000	17

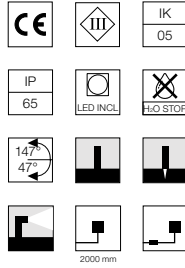
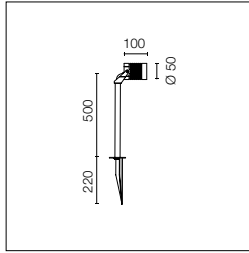

Source LED incluse. Source d'alimentation électrique à distance 24v dc ON/OFF, à commander séparément. Équipé d'un câble sortant de 2000 mm en néoprène et d'une boîte de dérivation à 2 pôles et 3 voies, avec système H2O0 STOP qui garantit l'étanchéité de la connexion. Verre transparent extra-clair Clou métallique pour l'installation au sol inclus. . Version à intensité réglable disponible sur demande.

LED source included. Remote electrical power supply 24V dc ON/OFF to be ordered separately. Equipped with a 2000 mm protruding section of neoprene cable and a 2-pole and 3-way connection box with H2O STOP system that guarantee the tightness of the connection. Extraclear transparent glass. Metal nail for ground installation included. Dimmable version available upon request.

2200K disponible sur demande.

2200K available on request.

Optic Spot 10°

Power Led: 3,4W - 199 lm ≠ OUTPUT 138 lm - 2700K/CRI 80 - 24Vdc / 3,4W - 215 lm ≠ OUTPUT 149 lm - 3000K/CRI 80 - 24Vdc / 3,4W - 224 lm ≠ OUTPUT 155 lm - 4000K/CRI 80 - 24Vdc

2700K

- FA51308801 288,00 €
- FA51308806 288,00 €
- FA51308812 288,00 €
- FA51308818 288,00 €
- FA51308830 288,00 €
- FA51308833 288,00 €

3000K

- FA51303601 288,00 €
- FA51303606 288,00 €
- FA51303612 288,00 €
- FA51303618 288,00 €
- FA51303630 288,00 €
- FA51303633 288,00 €

4000K

- FA51303501 288,00 €
- FA51303506 288,00 €
- FA51303512 288,00 €
- FA51303518 288,00 €
- FA51303530 288,00 €
- FA51303533 288,00 €

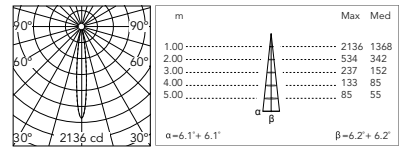

@3000K

Optic Medium 30°

Power Led: 3,4W - 199 lm ≠ OUTPUT 121 lm - 2700K/CRI 80 - 24Vdc / 3,4W - 215 lm ≠ OUTPUT 131 lm - 3000K/CRI 80 - 24Vdc / 3,4W - 224 lm ≠ OUTPUT 136 lm - 4000K/CRI 80 - 24Vdc

2700K

- FA51309001 288,00 €
- FA51309006 288,00 €
- FA51309012 288,00 €
- FA51309018 288,00 €
- FA51309030 288,00 €
- FA51309033 288,00 €

3000K

- FA51303901 288,00 €
- FA51303906 288,00 €
- FA51303912 288,00 €
- FA51303918 288,00 €
- FA51303930 288,00 €
- FA51303933 288,00 €

4000K

- FA51303801 288,00 €
- FA51303806 288,00 €
- FA51303812 288,00 €
- FA51303818 288,00 €
- FA51303830 288,00 €
- FA51303833 288,00 €

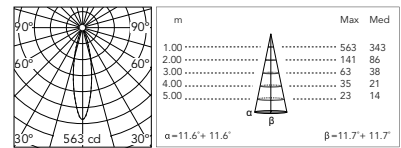

@3000K

* Nombre maximum de luminaires par source d'alimentation / Maximum number of luminaires per power supply.

Nombre maximum de luminaires par source d'alimentation (220÷240 V). Ces données doivent être vérifiées en prenant en compte les conditions spécifiques d'installation.	Maximum number of luminaires per power supply. (220÷240 V). These data must be checked taking into account the specific installation conditions.	Acc. RF25754	1	Acc. RF25757	2
		Acc. RF25748	1	Acc. RF25752	3
		Acc. FA235	1	Acc. F990B28A000	9
		Acc. RF25747	2	Acc. F990B27A000	17

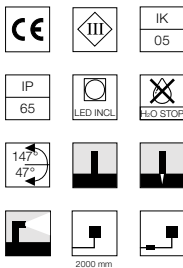
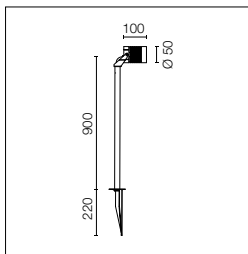

Source LED incluse. Source d'alimentation électrique à distance 24v dc ON/OFF, à commander séparément. Équipé d'un câble sortant de 2000 mm en néoprène et d'une boîte de dérivation à 2 pôles et 3 voies, avec système H200 STOP qui garantit l'étanchéité de la connexion. Verre transparent extra-clair Clou métallique pour l'installation au sol inclus. . Version à intensité réglable disponible sur demande.

LED source included. Remote electrical power supply 24V dc ON/OFF to be ordered separately. Equipped with a 2000 mm protruding section of neoprene cable and a 2-pole and 3-way connection box with H2O STOP system that guarantee the tightness of the connection. Extraclear transparent glass. Metal nail for ground installation included. Dimmable version available upon request.

2200K disponible sur demande.

2200K available on request.

Optic Spot 10°

Power Led: 3,4W - 199 lm ≠ OUTPUT 138 lm - 2700K/CRI 80 - 24Vdc / 3,4W - 215 lm ≠ OUTPUT 149 lm - 3000K/CRI 80 - 24Vdc / 3,4W - 224 lm ≠ OUTPUT 155 lm - 4000K/CRI 80 - 24Vdc

2700K

- FA51309201 288,00 €
- FA51309206 288,00 €
- FA51309212 288,00 €
- FA51309218 288,00 €
- FA51309230 288,00 €
- FA51309233 288,00 €

3000K

- FA51304801 288,00 €
- FA51304806 288,00 €
- FA51304812 288,00 €
- FA51304818 288,00 €
- FA51304830 288,00 €
- FA51304833 288,00 €

4000K

- FA51304701 288,00 €
- FA51304706 288,00 €
- FA51304712 288,00 €
- FA51304718 288,00 €
- FA51304730 288,00 €
- FA51304733 288,00 €

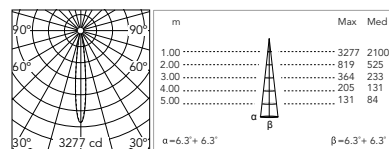

@3000K

Optic Medium 30°

Power Led: 3,4W - 199 lm ≠ OUTPUT 121 lm - 2700K/CRI 80 - 24Vdc / 3,4W - 215 lm ≠ OUTPUT 131 lm - 3000K/CRI 80 - 24Vdc / 3,4W - 224 lm ≠ OUTPUT 136 lm - 4000K/CRI 80 - 24Vdc

2700K

- FA51309401 288,00 €
- FA51309406 288,00 €
- FA51309412 288,00 €
- FA51309418 288,00 €
- FA51309430 288,00 €
- FA51309433 288,00 €

3000K

- FA51305101 288,00 €
- FA51305106 288,00 €
- FA51305112 288,00 €
- FA51305118 288,00 €
- FA51305130 288,00 €
- FA51305133 288,00 €

4000K

- FA51305001 288,00 €
- FA51305006 288,00 €
- FA51305012 288,00 €
- FA51305018 288,00 €
- FA51305030 288,00 €
- FA51305033 288,00 €

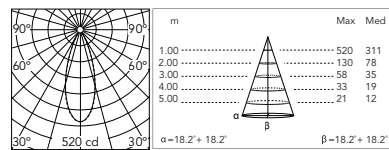

@3000K

* Nombre maximum de luminaires par source d'alimentation / Maximum number of luminaires per power supply.

Acc.	RF25754	1	RF25757	2
Acc. RF25748	1		Acc. RF25752	3
Acc. FA235	1		Acc. F990B28A000	9
Acc. RF25747	2		Acc. F990B27A000	17

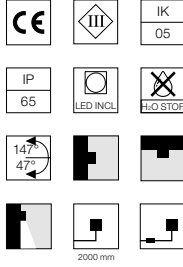
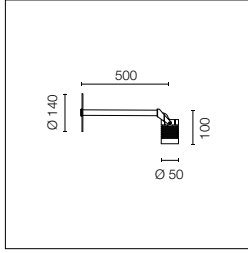

Source LED incluse. Source d'alimentation électrique à distance 24v dc ON/OFF, à commander séparément. Équipé d'un câble sortant de 2000 mm en néoprène et d'une boîte de dérivation à 2 pôles et 3 voies, avec système H2O0 STOP qui garantit l'étanchéité de la connexion. Verre transparent extra-clair Clou métallique pour l'installation au sol inclus. . Version à intensité réglable disponible sur demande.

LED source included. Remote electrical power supply 24V dc ON/OFF to be ordered separately. Equipped with a 2000 mm protruding section of neoprene cable and a 2-pole and 3-way connection box with H2O STOP system that guarantee the tightness of the connection. Extraclear transparent glass. Metal nail for ground installation included. Dimmable version available upon request.

2200K disponible sur demande.

2200K available on request.

Optic Spot 10°

Power Led: 3,4W - 199 lm ≠ OUTPUT 138 lm - 2700K/CRI 80 - 24Vdc / 3,4W - 215 lm ≠ OUTPUT 149 lm - 3000K/CRI 80 - 24Vdc / 3,4W - 224 lm ≠ OUTPUT 155 lm - 4000K/CRI 80 - 24Vdc

2700K

○ FA51309601	288,00 €
● FA51309606	288,00 €
● FA51309612	288,00 €
● FA51309618	288,00 €
● FA51309630	288,00 €
● FA51309633	288,00 €

3000K

○ FA51306001	288,00 €
● FA51306006	288,00 €
● FA51306012	288,00 €
● FA51306018	288,00 €
● FA51306030	288,00 €
● FA51306033	288,00 €

4000K

○ FA51305901	288,00 €
● FA51305906	288,00 €
● FA51305912	288,00 €
● FA51305918	288,00 €
● FA51305930	288,00 €
● FA51305933	288,00 €

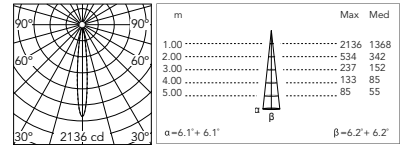

@3000K

Optic Medium 30°

Power Led: 3,4W - 199 lm ≠ OUTPUT 121 lm - 2700K/CRI 80 - 24Vdc / 3,4W - 215 lm ≠ OUTPUT 131 lm - 3000K/CRI 80 - 24Vdc / 3,4W - 224 lm ≠ OUTPUT 136 lm - 4000K/CRI 80 - 24Vdc

2700K

○ FA51309801	288,00 €
● FA51309806	288,00 €
● FA51309812	288,00 €
● FA51309818	288,00 €
● FA51309830	288,00 €
● FA51309833	288,00 €

3000K

○ FA51306301	288,00 €
● FA51306306	288,00 €
● FA51306312	288,00 €
● FA51306318	288,00 €
● FA51306330	288,00 €
● FA51306333	288,00 €

4000K

○ FA51306201	288,00 €
● FA51306206	288,00 €
● FA51306212	288,00 €
● FA51306218	288,00 €
● FA51306230	288,00 €
● FA51306233	288,00 €

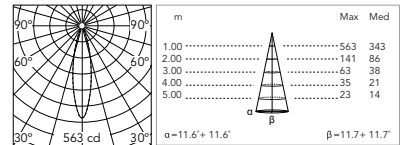

@3000K

* Nombre maximum de luminaires par source d'alimentation / Maximum number of luminaires per power supply.

Nombre maximum de luminaires par source d'alimentation (220-240 V). Ces données doivent être vérifiées en prenant en compte les conditions spécifiques d'installation.	Maximum number of luminaires per power supply. (220-240 V). These data must be checked taking into account the specific installation conditions.	Acc. RF25754	1	Acc. F990B28A000	9
		Acc. RF25748	1	Acc. F990B27A000	17
		Acc. RF25752	3		

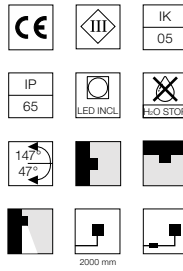
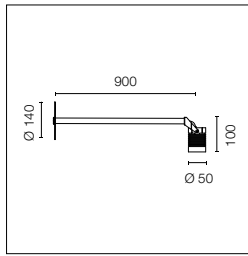

Source LED incluse. Source d'alimentation électrique à distance 24v dc ON/OFF, à commander séparément. Équipé d'un câble sortant de 2000 mm en néoprène et d'une boîte de dérivation à 2 pôles et 3 voies, avec système H2O STOP qui garantit l'étanchéité de la connexion. Verre transparent extra-clair
Clou métallique pour l'installation au sol inclus. .
Version à intensité réglable disponible sur demande.

LED source included. Remote electrical power supply 24V dc ON/OFF to be ordered separately. Equipped with a 2000 mm protruding section of neoprene cable and a 2-pole and 3-way connection box with H2O STOP system that guarantee the tightness of the connection. Extraclear transparent glass.
Metal nail for ground installation included. Dimmable version available upon request.

2200K disponible sur demande.

2200K available on request.

Optic Spot 10°

Power Led: 3,4W - 199 lm ≠ OUTPUT 138 lm - 2700K/CRI 80 - 24Vdc / 3,4W - 215 lm ≠ OUTPUT 149 lm - 3000K/CRI 80 - 24Vdc / 3,4W - 224 lm ≠ OUTPUT 155 lm - 4000K/CRI 80 - 24Vdc

2700K		3000K		4000K	
○ FA51310001	288,00 €	○ FA51306601	288,00 €	○ FA51306501	288,00 €
● FA51310006	288,00 €	● FA51306606	288,00 €	● FA51306506	288,00 €
● FA51310012	288,00 €	● FA51306612	288,00 €	● FA51306512	288,00 €
● FA51310018	288,00 €	● FA51306618	288,00 €	● FA51306518	288,00 €
● FA51310030	288,00 €	● FA51306630	288,00 €	● FA51306530	288,00 €
● FA51310033	288,00 €	● FA51306633	288,00 €	● FA51306533	288,00 €

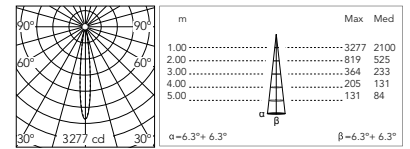

@3000K

Optic Medium 30°

Power Led: 3,4W - 199 lm ≠ OUTPUT 121 lm - 2700K/CRI 80 - 24Vdc / 3,4W - 215 lm ≠ OUTPUT 131 lm - 3000K/CRI 80 - 24Vdc / 3,4W - 224 lm ≠ OUTPUT 136 lm - 4000K/CRI 80 - 24Vdc

2700K		3000K		4000K	
○ FA51310201	288,00 €	○ FA51306901	288,00 €	○ FA51306801	288,00 €
● FA51310206	288,00 €	● FA51306906	288,00 €	● FA51306806	288,00 €
● FA51310212	288,00 €	● FA51306912	288,00 €	● FA51306812	288,00 €
● FA51310218	288,00 €	● FA51306918	288,00 €	● FA51306818	288,00 €
● FA51310230	288,00 €	● FA51306930	288,00 €	● FA51306830	288,00 €
● FA51310233	288,00 €	● FA51306933	288,00 €	● FA51306833	288,00 €

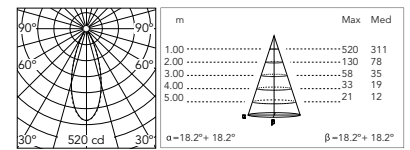





@3000K

* Nombre maximum de luminaires par source d'alimentation / Maximum number of luminaires per power supply.

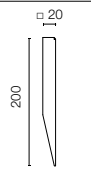
Configuration	Maximum number of luminaires per power supply (220÷240 V). These data must be checked taking into account the specific installation conditions.
Acc. RF25754	1
Acc. RF25748	1
Acc. RF25752	3
Acc. F990B28A000	9
Acc. F990B27A000	17

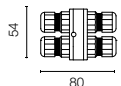

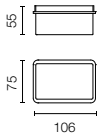



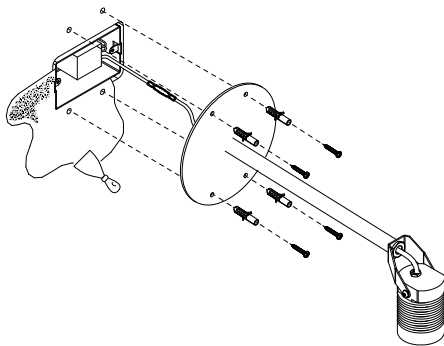



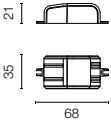

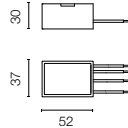

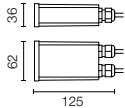
Aimer 2: Accessoires / Accessories

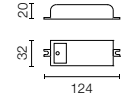
Pique pour la fixation au sol.	Ground spike.	Spot / Bollard FA136	34,00 €		
Système de jonction IP68 H2O Stop anti-condensation à 3/4 voies 4 pôles. (Ø5,5÷12mm câble).	3/4 way terminal block 4 poles IP68 H2O Stop. (ø5,5÷12mm cable).	Bollard F990C010000	60,00 €		
Boitier de dérivation à encastrer 3 modules (modèle 503)	Recessed 3-module junction box (model 503)	Wall F990H010000	12,00 €		

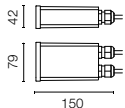
Aimer 2 Wall Bracket with box cod. F990H010000

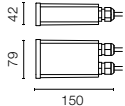

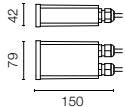
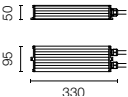
Aimer 2: Appareillages électriques / Drivers

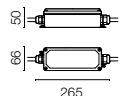
Source d'alimentation avec fonction dual Vout 24Vdc : 8W/100÷240V Iout 350ma: 6x1W/100÷240V IP20 Classe II Selv Eq.	Power supply dual function Vout 24Vdc: 8W/100÷240V Iout 350ma: 6x1W/100÷240V IP20 Class II Selv Eq.	*RF25754	36,00 €		
Équipement d'alimentation 24V 8W / 110-240V IP65 Classe II selv.	Power supply 24V 8W / 110-240V IP65 Class II selv.	*RF25748	63,00 €		
Équipement d'alimentation 8W/110÷240V - 24Vdc IP67 Classe II selv. Eq.	Power supply 8W/110÷240V - 24Vdc IP67 Class II selv. Eq.	Bollard *FA235	86,00 €		
Équipement d'alimentation 24V 10W / 110-240V IP20 Classe II selv.	Power supply 24V 10W / 110-240V IP20 Class II selv.	Spot / Bollard *RF25747	48,00 €		
Équipement d'alimentation 24V 10W / 110-240V IP67 Classe II selv.	Power supply 24V 10W / 110-240V IP67 Class II selv.	Spot / Bollard *RF25757	86,00 €		
Équipement d'alimentation pour installation à distance 24Vdc 20W / 220-240V IP67 Classe II selv.	Power supply for remote installation 24Vdc 20W / 220-240V IP67 Class II selv.	Bollard / Wall *RF25752	133,00 €		
Alimentation 24Vdc 35W / 120-270V IP67 Classe II selv.	Power supply 24Vdc 35W / 120-270V IP67 Class II selv.	F990B23AZ00	180,00 €		
Équipement d'alimentation pour installation à distance 24Vdc 50W / 120-240V IP67 Classe II selv.	Power supply for remote installation 24Vdc 50W / 120-240V IP67 Class II selv.	*F990B28A000	251,00 €		
Équipement d'alimentation pour installation à distance 24Vdc 70W / 220-240V IP67 Classe II selv.	Power supply for remote installation 24Vdc 70W / 220-240V IP67 Class II selv.	*F990B27A000	212,00 €		

Aimer 1 Aqua

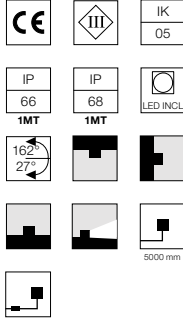
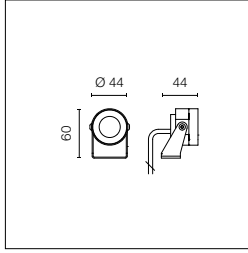

Source LED incluse. Structure et équerre en acier inoxydable 316L pouvant être immergées. Source d'alimentation électrique à distance 350 mA ON/ OFF et intensité réglable entre 1 y 10V o DALI, à commander séparément. Connexion en série. Équipé d'un câble sortant de 5000 mm en néoprène, et d'un kit avec des connecteurs sertissables et des gaines thermorétractables adhésives qui garantissent l'étanchéité de la connexion. Verre transparent extra-clair. Clou métallique pour l'installation au sol, à commander séparément. Modèles 2700K et 3000 K disponibles sur demande.

LED source. 316L stainless steel body and bracket, suitable for submersion. Remote power supply 350 mA ON/OFF and dimmable 1-10V or DALI. Must be ordered separately. Serial connection. Equipped with a 5000 mm protruding section of neoprene cable and a kit with crimpable connectors and adhesive heat-shrinkable sleeves that guarantee the tightness of the connection. Extraclear transparent glass. The metal nail for ground installation needs to be ordered separately. 2700K and 3000K models available upon request.

2200K disponible sur demande.

2200K available on request.

Optic Medium 30°

Power Led: 1,1W - LED 120 lm ≠ OUTPUT 99 lm - 3000K/CRI 80 - 350 mA / 1,1W - 124 lm ≠ OUTPUT 103 lm - 4000K/CRI 80 - 350 mA

3000K

FA10517114557.A 186,00 €

4000K

FA10517114357.A 186,00 €

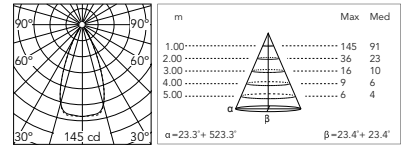

@ 4000K

* Nombre maximum de luminaires par source d'alimentation / Maximum number of luminaires per power supply.

Nombre maximum de luminaires par source d'alimentation (220-240 V). Ces données doivent être vérifiées en prenant en compte les conditions spécifiques d'installation.

Maximum number of luminaires per power supply. (220-240 V). These data must be checked taking into account the specific installation conditions.

Acc. RF25748 6
Acc. FA184 **16
Acc. FA238.A **9

**La tension entre les extrémités du système dépend du nombre de luminaires connectés en série. Veuillez vous en tenir à la norme CEI 64-8.

**The voltage at the end of the system depends on the number of fixtures connected in series, please comply with CEI 64-8 standards.

Aimer 1 Aqua RGB

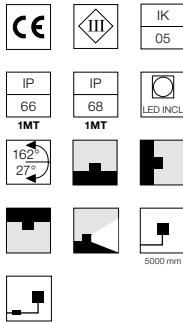
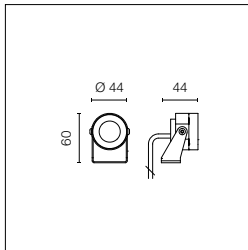

Source LED RGB incluse. Structure et équerre en acier inoxydable 316L pouvant être immergées. Source d'alimentation électrique à distance avec interface DMX 3CHx350mA à commander séparément. Connexion en série. Équipé d'un câble sortant de 5000 mm en néoprène, et d'un kit avec des connecteurs sertissables et des gaines thermorétractables adhésives qui garantissent l'étanchéité de la connexion. Verre sérigraphié sablé. Équerre de maintien incluse. Clou métallique pour l'installation au sol, à commander séparément.

RGB LED source included. 316L stainless steel body and bracket, suitable for submersion. Remote electrical power supply with DMX 3CHx350mA interface to be ordered separately. Serial connection. Equipped with a 5000 mm protruding section of neoprene cable and a kit with crimpable connectors and adhesive heat-shrinkable sleeves that guarantee the tightness of the connection. Sandblasted screen-printed glass. Fixing bracket included. The metal nail for ground installation needs to be ordered separately.

Schéma électrique et installation système RGB.

10 luminaires Aimer 1 Aqua RGB maximum pour chaque code F990B22A000.

Voir schéma électrique n.5 Page 832.

Wiring diagram and installation scheme RGB.

Max 10 luminaires Aimer 1 Aqua RGB for each code F990B22A000.

See Wiring Diagram n.5 Page 832.

RGB Power Led: 3,4W - 3CH x 350mA

RGB

FA10517314357.A 198,00 €

Photometric data on request.

* Nombre maximum de luminaires par source d'alimentation / Maximum number of luminaires per power supply.

Nombre maximum de luminaires par source d'alimentation (220-240 V). Ces données doivent être vérifiées en prenant en compte les conditions spécifiques d'installation.

Maximum number of luminaires per power supply. (220-240 V). These data must be checked taking into account the specific installation conditions.

Acc. F990B22A000 **10

**La tension entre les extrémités du système dépend du nombre de luminaires connectés en série. Veuillez vous en tenir à la norme CEI 64-8.

**The voltage at the end of the system depends on the number of fixtures connected in series, please comply with CEI 64-8 standards.

Aimer 3 Aqua

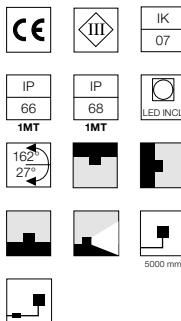
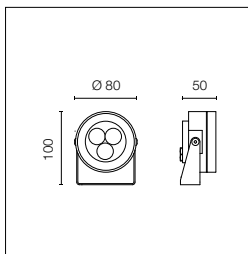

Source LED incluse. Structure et équerre en acier inoxydable 316L pouvant être immergées. Source d'alimentation électrique à distance 24v dc ON/OFF, à commander séparément. Connexion en parallèle. Équipé d'un câble sortant de 5000 mm en néoprène, et d'un kit avec des connecteurs sertissables et des gaines thermorétractables adhésives qui garantissent l'étanchéité de la connexion. Équerre de maintien incluse. Verre transparent extra-clair. Clou métallique pour l'installation au sol, à commander séparément. Modèles 2700K et 3000K disponibles sur demande.

LED source included. 316L stainless steel body and bracket, suitable for submersion. Remote electrical power supply 24V dc ON/OFF to be ordered separately. Parallel connection. Equipped with a 5000 mm protruding section of neoprene cable and a kit with crimpable connectors and adhesive heat-shrinkable sleeves that guarantee the tightness of the connection. Fixing bracket included. Extraclear transparent glass. The metal nail for ground installation needs to be ordered separately. 2700K and 3000K models available upon request.

2200K disponible sur demande.

2200K available on request.

Optic Medium 50°

Power Led: 3,3W - 359 lm ≠ OUTPUT 267 lm - 3000K/CRI 80 - 24Vdc / 3,3W - 373 lm ≠ OUTPUT 278 lm - 4000K/CRI 80 - 24Vdc

3000K

● FA10517214657 309,00 €

4000K

● FA10517214457 309,00 €

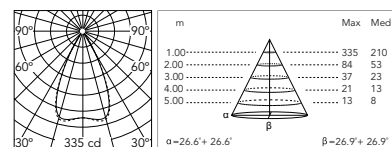

@ 4000K

* Nombre maximum de luminaires par source d'alimentation / Maximum number of luminaires per power supply.

Nombre maximum de luminaires par source d'alimentation (220-240 V). Ces données doivent être vérifiées en prenant en compte les conditions spécifiques d'installation.

Maximum number of luminaires per power supply. (220-240 V). These data must be checked taking into account the specific installation conditions.

Acc. RF25748 1
Acc. RF25757 2
Acc. RF25752 3

Acc. F990B28A000 7
Acc. F990B27A000 14

Aimer 3 Aqua RGB

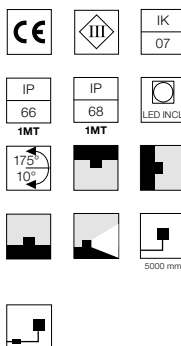
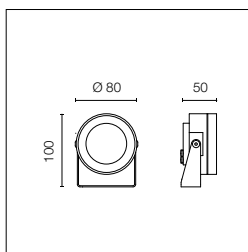

Source LED RGB incluse. Structure et équerre en acier inoxydable 316L pouvant être immergées. Source d'alimentation électrique à distance avec interface DMX 3CHx350mA à commander séparément. Connexion en série. Équipé d'un câble sortant de 5000 mm en néoprène, et d'un kit avec des connecteurs sertissables et des gaines thermorétractables adhésives qui garantissent l'étanchéité de la connexion. Verre sérigraphié transparent. Équerre de maintien incluse. Clou métallique pour l'installation au sol, à commander séparément.

RGB LED source included. 316L stainless steel body and bracket, suitable for submersion. Remote electrical power supply with DMX 3CHx350mA interface to be ordered separately. Serial connection. Equipped with a 5000 mm protruding section of neoprene cable and a kit with crimpable connectors and adhesive heat-shrinkable sleeves that guarantee the tightness of the connection. Transparent screen-printed glass. Fixing bracket included. The metal nail for ground installation needs to be ordered separately.

Schéma électrique et installation système RGB.

10 luminaires Aimer 3 Aqua RGB maximum pour chaque code F990B22A000.

Voir schéma électrique n.5 Page 832.

Wiring diagram and installation scheme RGB.

Max 10 luminaires Aimer 3 Aqua RGB for each code F990B22A000.

See Wiring Diagram n.5 Page 832.

Optic Medium 35°

RGB Power Led: 3,4W - 3CH x 350mA

RGB

● FA10517414457 309,00 €

Photometric data on request.

* Nombre maximum de luminaires par source d'alimentation / Maximum number of luminaires per power supply.

Nombre maximum de luminaires par source d'alimentation (220-240 V). Ces données doivent être vérifiées en prenant en compte les conditions spécifiques d'installation.

Maximum number of luminaires per power supply. (220-240 V). These data must be checked taking into account the specific installation conditions.

Acc. F990B22A000 **10

**La tension entre les extrémités du système dépend du nombre de luminaires connectés en série. Veuillez vous en tenir à la norme CEI 64-8.

**The voltage at the end of the system depends on the number of fixtures connected in series, please comply with CEI 64-8 standards.

Aimer 4 Aqua

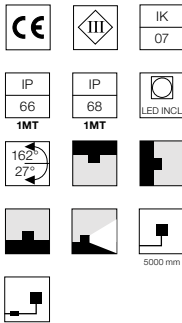
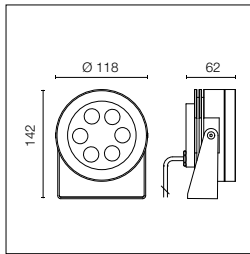

Source LED incluse. Structure et équerre en acier inoxydable 316L pouvant être immergées. Source d'alimentation électrique à distance 24v dc ON/OFF, à commander séparément. Connexion en parallèle. Équipé d'un câble sortant de 5000 mm en néoprène, et d'un kit avec des connecteurs sertissables et des gaines thermorétractables adhésives qui garantissent l'étanchéité de la connexion. Équerre de maintien incluse. Verre transparent extra-clair. Clou métallique pour l'installation au sol, à commander séparément. Modèles 2700K et 3000K disponibles sur demande.

LED source included. 316L stainless steel body and bracket, suitable for submersion. Remote electrical power supply 24V dc ON/OFF to be ordered separately. Parallel connection. Equipped with a 5000 mm protruding section of neoprene cable and a kit with crimpable connectors and adhesive heat-shrinkable sleeves that guarantee the tightness of the connection. Fixing bracket included. Extraclear transparent glass. The metal nail for ground installation needs to be ordered separately. 2700K and 3000K models available upon request.

2200K disponible sur demande.

2200K available on request.

Optic Medium 26°

Power Led: 8W - 646 lm ≠ OUTPUT 409 lm - 3000K/CRI 80 - 24Vdc / 8W - 687 lm ≠ OUTPUT 435 lm - 4000K/CRI 80 - 24Vdc

3000K

FA10526614757 615,00 €

4000K

FA10526614557 615,00 €

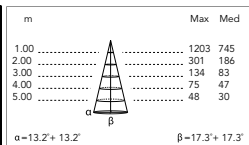
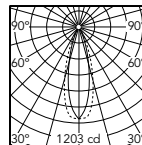

@ 4000K

* Nombre maximum de luminaires par source d'alimentation / Maximum number of luminaires per power supply.

Nombre maximum de luminaires par source d'alimentation (220÷240 V). Ces données doivent être vérifiées en prenant en compte les conditions spécifiques d'installation.

Maximum number of luminaires per power supply. (220÷240 V). These data must be checked taking into account the specific installation conditions.

Acc. F990B28A000 3
Acc. F990B27A000 6

Aimer 5 Aqua

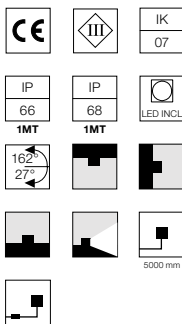
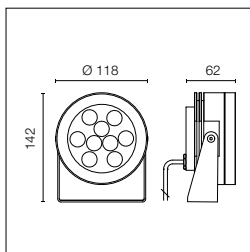

Source LED incluse. Structure et équerre en acier inoxydable 316L pouvant être immergées. Source d'alimentation électrique à distance 24v dc ON/OFF, à commander séparément. Connexion en parallèle. Équipé d'un câble sortant de 5000 mm en néoprène, et d'un kit avec des connecteurs sertissables et des gaines thermorétractables adhésives qui garantissent l'étanchéité de la connexion. Équerre de maintien incluse. Verre transparent extra-clair. Clou métallique pour l'installation au sol, à commander séparément. Modèles 2700K et 3000K disponibles sur demande.

LED source included. 316L stainless steel body and bracket, suitable for submersion. Remote electrical power supply 24V dc ON/OFF to be ordered separately. Parallel connection. Equipped with a 5000 mm protruding section of neoprene cable and a kit with crimpable connectors and adhesive heat-shrinkable sleeves that guarantee the tightness of the connection. Fixing bracket included. Extraclear transparent glass. The metal nail for ground installation needs to be ordered separately. 2700K and 3000K models available upon request.

2200K disponible sur demande.

2200K available on request.

Optic Medium 28°

Power Led: 11W - 969 lm ≠ OUTPUT 680 lm - 3000K/CRI 80 - 24Vdc / 11W - 1031 lm ≠ OUTPUT 723 lm - 4000K/CRI 80 - 24Vdc

3000K

FA10521114757 689,00 €

4000K

FA10521114557 689,00 €

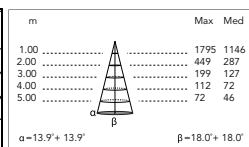
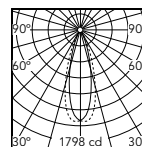

@ 4000K

* Nombre maximum de luminaires par source d'alimentation / Maximum number of luminaires per power supply.

Nombre maximum de luminaires par source d'alimentation (220÷240 V). Ces données doivent être vérifiées en prenant en compte les conditions spécifiques d'installation.

Maximum number of luminaires per power supply. (220÷240 V). These data must be checked taking into account the specific installation conditions.

Acc. F990B28A000 3
Acc. F990B27A000 7
Acc. FA184 1

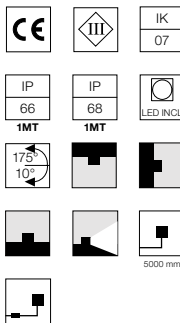
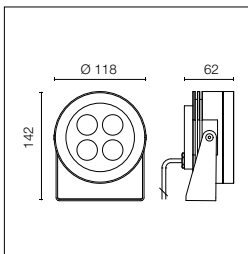

Source LED RGB incluse. Structure et équerre en acier inoxydable 316L pouvant être immergées. Source d'alimentation électrique à distance avec interface DMX 3CHx350mA à commander séparément. Connexion en série. Équipé d'un câble sortant de 5000 mm en néoprène, et d'un kit avec des connecteurs sertissables et des gaines thermorétractables adhésives qui garantissent l'étanchéité de la connexion. Transparentes Glas mit Siebdruck. Équerre de maintien incluse. Clou métallique pour l'installation au sol, à commander séparément.

RGB LED source included. 316L stainless steel body and bracket, suitable for submersion. Remote electrical power supply with DMX 3CHx350mA interface to be ordered separately. Serial connection. Equipped with a 5000 mm protruding section of neoprene cable and a kit with crimpable connectors and adhesive heat-shrinkable sleeves that guarantee the tightness of the connection. Transparent screen-printed glass. Fixing bracket included. The metal nail for ground installation needs to be ordered separately.

Schéma électrique et installation système RGB.

2 luminaires Aimer 5 Aqua RGB maximum pour chaque code F990B22A000.

Voir schéma électrique n.5 Page 832.

Wiring diagram and installation scheme RGB.

Max 2 luminaires Aimer 5 Aqua RGB for each code F990B22A000.

See Wiring Diagram n.5 Page 832.

Optic Medium 50°

RGB Power Led: 13,6W - 3CH x 350mA

RGB

FA10525614557 615,00 €

Photometric data on request.

* Nombre maximum de luminaires par source d'alimentation / Maximum number of luminaires per power supply.

Nombre maximum de luminaires par source d'alimentation (220÷240 V). Ces données doivent être vérifiées en prenant en compte les conditions spécifiques d'installation.





Maximum number of luminaires per power supply, (220÷240 V). These data must be checked taking into account the specific installation conditions.

Acc. *F990B22A000 **2



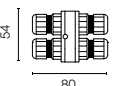

**La tension entre les extrémités du système dépend du nombre de luminaires connectés en série. Veuillez vous en tenir à la norme CEI 64-8.

**The voltage at the end of the system depends on the number of fixtures connected in series, please comply with CEI 64-8 standards.





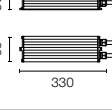

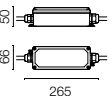

Aimer Aqua: Accessoires / Accessories

Pique pour la fixation au sol.	Ground spike.	Aqua Aimer 1 / 3 / 4 / 5 FA136	34,00 €		
Système de jonction IP68 H2O Stop anti-condensation à 3/4 voies 4 pôles. (Ø5,5÷12mm câble).	3/4 way terminal block 4 poles IP68 H2O Stop. (ø5,5÷12mm cable).	Aqua Aimer 3 / 4 / 5 F990C010000	60,00 €		
Système de jonction IP68 H2O Stop anti-condensation à 2 voies 4 pôles. (Ø5,5÷12mm câble).	2 way terminal block 4 poles IP68 H2O Stop. (ø5,5÷12mm cable).	Aqua Aimer 3 / 4 / 5 F990C00A000	33,00 €		

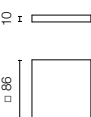
Aimer Aqua: Appareillages électriques / Drivers

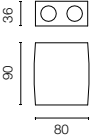
Équipement d'alimentation 24V 8W / 110-240V IP65 Classe II selv.	Power supply 24V 8W / 110-240V IP65 Class II selv.	Aqua Aimer 1 / 3 *RF25748	63,00 €		
Équipement d'alimentation 16 x 1W/ 110÷240V - Iout 350mA (12x1W@110V) IP67 Classe II selv.	Power supply 16 x 1W/ 110÷240V - Iout 350mA (12x1W@110V) IP67 Class II Selv.	Aqua Aimer 1 / 5 *FA184  Dimmable Push-Dim Or 1-10V See Wiring Diagram n.3. Page 830	155,00 €		
Équipement d'alimentation 18W/ 110÷240V - Iout 350mA (15W@110V) IP67 Classe II selv. C	Power supply 18W/ 110÷240V - Iout 350mA (15W@110V) IP67 Class II Selv. C.	Aqua Aimer 1 / 3 *FA238.A  Dimmable DALI See Wiring Diagram n.3. Page 830	159,00 €		
Équipement d'alimentation 24V 10W / 110-240V IP67 Classe II selv.	Power supply 24V 10W / 110-240V IP67 Class II selv.	Aqua Aimer 3 / 4 / 5 *RF25757	86,00 €		
Équipement d'alimentation pour installation à distance 24Vdc 20W / 220-240V IP67 Classe II selv.	Power supply for remote installation 24Vdc 20W / 220-240V IP67 Class II selv.	Aqua Aimer 3 / 4 / 5 *RF25752	133,00 €		
Alimentation 24Vdc 35W / 120-270V IP67 Classe II selv.	Power supply 24Vdc 35W / 120-270V IP67 Class II selv.	F990B23AZ00	180,00 €		
Équipement d'alimentation pour installation à distance 24Vdc 50W / 120-240V IP67 Classe II selv.	Power supply for remote installation 24Vdc 50W / 120-240V IP67 Class II selv.	Aqua Aimer 3 / 4 / 5 *F990B28A000	251,00 €		
Équipement d'alimentation pour installation à distance 24Vdc 70W / 220-240V IP67 Classe II selv.	Power supply for remote installation 24Vdc 70W / 220-240V IP67 Class II selv.	Aqua Aimer 3 / 4 / 5 *F990B27A000	212,00 €		

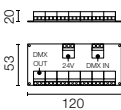
Aimer Aqua RGB: Accessoires / Accessories

Pique pour la fixation au sol.	Ground spike.	Aqua Aimer 1 / 3 / 4 / 5 RGB FA136	34,00 €		
Contrôleur DMX pour boîtes encastrables. (60 mm d'entraxe)	DMX controller; dimmer switch for recessed box (60mm hole centres).	F990B10A000	1.006,00 €		
Contrôleur DMX. Interface stand/alone PC.	DMX controller; stand-alone/PC interface.	F990B11A000	1.306,00 €		
DMX splitter 512- dispositif électronique pour régénérer le signal dmx monodirectionnel. 1 entrée et 7 sorties, 12-24 Vdc. Source d'alimentation non incluse.	DMX splitter 512 - electronic device to regenerate the monodirectional DMX signal 1 Input and 7 output, 12-24Vdc.	F990B13A000	227,00 €		
Câble DMX blindé à impédance constante 110 Ohm.	DMX cable - shielded twisted pair with 110 Ohm constant impedance.	F990B12A000	19,00 €		

Aimer Aqua RGB: Appareillages électriques / Drivers

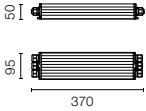
Source d'alimentation avec interface dmx pour luminaires RGB 36W/220÷240V-3CH x 350mA (3CH x 10 x 1W) réglage préalable DMX IP67 Classe I Selv Eq.	Power supply with DMX interface for RGB fixtures 36W/220÷240V-3CH x 350mA (3CH x 10 x 1W) DMX control allowed IP67 Class I Selv Eq.	*F990B22A000	246,00 €		
--	---	--------------	----------	---	---

Franco





Franco



Famille / Family

Franco 1



CoB Led

up to 24W
up to 1920 lm - 2700K/CRI 80
up to 2065 lm - 3000K/CRI 80
up to 2166 lm - 4000K/CRI 80

Power Led

up to 20W
up to 1506 lm - 2700K/CRI 80
up to 1619 lm - 3000K/CRI 80
up to 1698 lm - 4000K/CRI 80

2200K available on request.

Franco 2



CoB Led

up to 43W
up to 3143 lm - 2700K/CRI 80
up to 3380 lm - 3000K/CRI 80
up to 3465 lm - 4000K/CRI 80

Franco 3



CoB Led

up to 52W
up to 3757 lm - 2700K/CRI 80
up to 4040 lm - 3000K/CRI 80
up to 4142 lm - 4000K/CRI 80

Power Led

up to 43W
up to 3676 lm - 2700K/CRI 80
up to 3939 lm - 3000K/CRI 80
up to 4070 lm - 4000K/CRI 80

2200K available on request.

Finitions / Colours



01 White



06 Grey



12 Forest Green



18 Deep Brown



30 Black



33 Anthracite

Description / Description

Famille de luminaires de projection ajustable avec source LED, conçus pour être installés au mur et avec un support type mât. Disponibles en trois tailles et avec des différents faisceaux lumineux pour chaque taille. Ils incluent des optiques pour une utilisation en milieu urbain. Structure en aluminium moulé sous pression EN AB-47100 (à faible teneur en cuivre) et réflecteur en aluminium extra-pur. Diffuseur en verre extra-clair avec un bord sérigraphié, fixé au cadre par un système d'encollage robotisé. Disponibles en différentes finitions avec un revêtement à poudre double couche et une surface traitée par procédé de conversion chimique pour garantir une haute résistance à la corrosion. Équerre de maintien en acier inoxydable AISI 316L, graduée pour garantir un ajustement précis de l'unité d'émission et une orientation d'environ 120° sur l'axe vertical. Complétés par une gaine en métal. Pour garantir l'étanchéité de la gaine il est conseillé d'utiliser des câbles électriques flexibles et conçus pour l'extérieur. Les luminaires sont complétés par une série de poteaux cylindriques avec des diamètres et hauteurs différents et qui peuvent être encastrés au sol ou être fixés à l'aide d'une plaque d'ancrage et des tire-fonds. La version MiniFranco est équipée d'un bras sortant pour être fixée au mur pour l'éclairage de panneaux.

Family of tiltable projection luminaires with LED source for wall and post mounting. Available in three dimensions and with different light beams for every dimension, including optics for urban uses. Die cast aluminum body EN AB-47100 (with low copper content) and super pure aluminum reflector. Extraclear glass diffuser with silkscreen edge, attached to the frame with a robotic gluing system. Available in different finishes, with double-layered powder coating and chemical conversion surface treatment to ensure high corrosion resistance. AISI 316L stainless steel fixing bracket, graduated to guarantee precision in the adjustment of the emission unit and a tilting of approx. 120° on the vertical axis. Completed with a metal cable guide. To ensure the tightness of the cable guide it's recommended to use flexible electric cables suitable for exterior use. Completed with a series of cylinder posts in different diameters and heights that can be ground recessed or fixed with an anchor plate and lag screws. The MiniFranco version is equipped with a protruding arm for wall mounting and sign lighting.

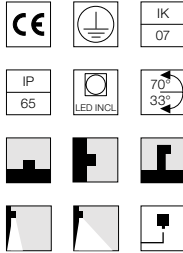
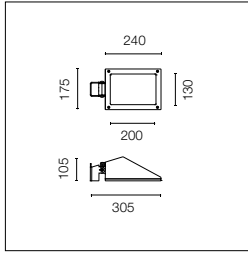

Source LED incluse. Source d'alimentation électrique intégrée 220-240V ON/OFF. Équerre de maintien incluse. Équipé d'une gaine en métal M16x1,5 (pour des câbles de 4,5mm-ø<10mm) et d'un connecteur IP68. Pour garantir l'étanchéité de la gaine il est conseillé d'utiliser des câbles électriques flexibles et conçus pour l'extérieur. Accessoires optionnels : poteaux ; supports et bras pour une installation en tant que mât; bras sortant mural.

LED source included. Integrated electrical power supply 220-240V ON/OFF. Fixing bracket included. Equipped with a M16x1.5 cable guide (for 4.5mm-ø<10mm cables) and IP68 connector. To ensure the tightness of the cable guide it's recommended to use flexible electric cables suitable for exterior use. Optional accessories: posts; mounts and arms to install as a mast; protruding arm for wall mounting.

Symmetric Optic

CoB Led: 24W - 2856 lm ≠ OUTPUT 1920 lm - 2700K/CRI 80 - 220-240V / 24W - 3071 lm ≠ OUTPUT 2065 lm - 3000K/CRI 80 - 220-240V / 24W - 3221 lm ≠ OUTPUT 2166 lm - 4000K/CRI 80 - 220-240V

2700K

- FA162812301.A 432,00 €
- FA162812306.A 432,00 €
- FA162812312.A 432,00 €
- FA162812318.A 432,00 €
- FA162812330.A 432,00 €
- FA162812333.A 432,00 €

3000K

- FA162811301 432,00 €
- FA162811306 432,00 €
- FA162811312 432,00 €
- FA162811318 432,00 €
- FA162811330 432,00 €
- FA162811333 432,00 €

4000K

- FA162801301.A 432,00 €
- FA162801306.A 432,00 €
- FA162801312.A 432,00 €
- FA162801318.A 432,00 €
- FA162801330.A 432,00 €
- FA162801333.A 432,00 €

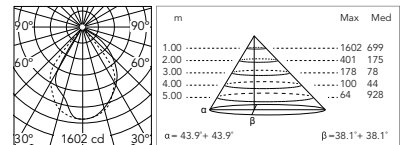

@ 3000K

Asymmetric Optic

CoB Led: 24W - 2856 lm ≠ OUTPUT 1506 lm - 2700K/CRI 80 - 220-240V / 24W - 3071 lm ≠ OUTPUT 1619 lm - 3000K/CRI 80 - 220-240V / 24W - 3221 lm ≠ OUTPUT 1698 lm - 4000K/CRI 80 - 220-240V

2700K

- FA162812401.A 432,00 €
- FA162812406.A 432,00 €
- FA162812412.A 432,00 €
- FA162812418.A 432,00 €
- FA162812430.A 432,00 €
- FA162812433.A 432,00 €

3000K

- FA162811401 432,00 €
- FA162811406 432,00 €
- FA162811412 432,00 €
- FA162811418 432,00 €
- FA162811430 432,00 €
- FA162811433 432,00 €

4000K

- FA162801401.A 432,00 €
- FA162801406.A 432,00 €
- FA162801412.A 432,00 €
- FA162801418.A 432,00 €
- FA162801430.A 432,00 €
- FA162801433.A 432,00 €

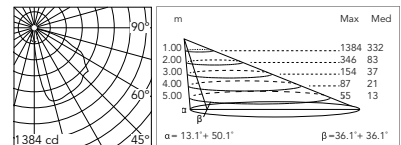

@ 3000K

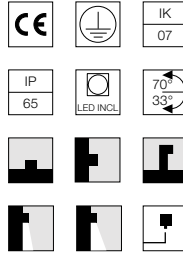
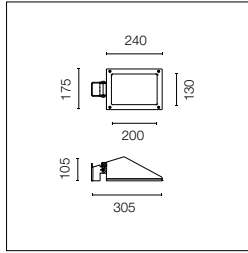
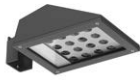

Source LED incluse. Source d'alimentation électrique intégrée 220-240V ON/OFF. Équerre de maintien incluse. Équipé d'une gaine en métal M16x1,5 (pour des câbles de 4,5mmϕ<math><10\text{mm}</math>). Pour garantir l'étanchéité de la gaine il est conseillé d'utiliser des câbles électriques flexibles et conçus pour l'extérieur. Accessoires optionnels : poteaux ; supports et bras pour une installation en tant que mât; bras sortant mural.

LED source included. Integrated electrical power supply 220-240V ON- OFF. Fixing bracket included. Equipped with a M16x1.5 cable guide (for 4.5mmϕ<math><10\text{mm}</math> cables) and IP68 connector. To ensure the tightness of the cable guide it's recommended to use flexible electric cables suitable for exterior use. Optional accessories: posts; mounts and arms to install as a mast; protruding arm for wall mounting.

2200K disponible sur demande.

2200K available on request.

Optic Spot 10°

Power Led: 20W - 1776 lm \neq OUTPUT 1371 lm - 2700K/CRI 80 - 220÷240V / 20W - 1914 lm \neq OUTPUT 1486 lm - 3000K/CRI 80 - 220÷240V / 20W - 1987 lm \neq OUTPUT 1543 lm - 4000K/CRI 80 - 220÷240V

2700K

- FA161012201 535,00 €
- FA161012206 535,00 €
- FA161012212 535,00 €
- FA161012218 535,00 €
- FA161012230 535,00 €
- FA161012233 535,00 €

3000K

- FA161011201 535,00 €
- FA161011206 535,00 €
- FA161011212 535,00 €
- FA161011218 535,00 €
- FA161011230 535,00 €
- FA161011233 535,00 €

4000K

- FA162241201 535,00 €
- FA162241206 535,00 €
- FA162241212 535,00 €
- FA162241218 535,00 €
- FA162241230 535,00 €
- FA162241233 535,00 €

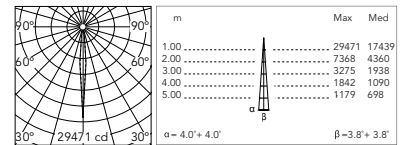

@ 3000K

Optic Medium 40°

Power Led: 20W - 1776 lm \neq OUTPUT 1281 lm - 2700K/CRI 80 - 220÷240V / 20W - 1914 lm \neq OUTPUT 1388 lm - 3000K/CRI 80 - 220÷240V / 20W - 1987 lm \neq OUTPUT 1442 lm - 4000K/CRI 80 - 220÷240V

2700K

- FA161012301 535,00 €
- FA161012306 535,00 €
- FA161012312 535,00 €
- FA161012318 535,00 €
- FA161012330 535,00 €
- FA161012333 535,00 €

3000K

- FA161011301 535,00 €
- FA161011306 535,00 €
- FA161011312 535,00 €
- FA161011318 535,00 €
- FA161011330 535,00 €
- FA161011333 535,00 €

4000K

- FA162241301 535,00 €
- FA162241306 535,00 €
- FA162241312 535,00 €
- FA162241318 535,00 €
- FA162241330 535,00 €
- FA162241333 535,00 €

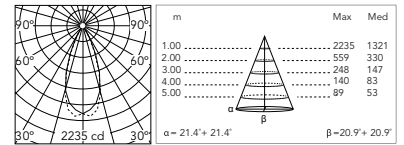

@ 3000K

Franco 1 / Ø 60mm - Poles

Avec base.
Complété avec un ancrage fixe sur la partie supérieure de la structure. Projecteur non ajustable.

With Base
With fixed pole head hooking. Non-adjustable projector



H 500mm	
○ FA100501	91,00 €
● FA100506	91,00 €
● FA100512	91,00 €
● FA100518	91,00 €
● FA100530	91,00 €
● FA100533	91,00 €
H 900mm	
○ FA100901	106,00 €
● FA100906	106,00 €
● FA100912	106,00 €
● FA100918	106,00 €
● FA100930	106,00 €
● FA100933	106,00 €
H 2000mm	
○ FA11701	140,00 €
● FA11706	140,00 €
● FA11712	140,00 €
● FA11718	140,00 €
● FA11730	140,00 €
● FA11733	140,00 €

Da Interrare (+300 mm Interrati)

Encastrable (+300 mm en dessous du sol)



H 500mm	
○ FA110501	67,00 €
● FA110506	67,00 €
● FA110512	67,00 €
● FA110518	67,00 €
● FA110530	67,00 €
● FA110533	67,00 €
H 900mm	
○ FA110901	82,00 €
● FA110906	82,00 €
● FA110912	82,00 €
● FA110918	82,00 €
● FA110930	82,00 €
● FA110933	82,00 €

Franco 1 / Ø 76mm - Poles

Avec base et boîte de dérivation.

With Base and Access Door.
With Terminal Block 4x1,5-16mmq.



H 3500mm	
● FA24806	702,00 €
● FA24833	702,00 €
H 4500mm	
● FA24906	852,00 €
● FA24933	852,00 €

Encastrable (+500 mm en dessous du sol)
Avec boîte de dérivation

In-Ground (+500 mm Root) With Access Door
With Terminal Block 4x1,5-16mmq



H 3500mm	
● FA25006	644,00 €
● FA25033	644,00 €
H 4500mm	
● FA25106	759,00 €
● FA25133	759,00 €

Franco 1 / Ø 102mm - Poles

Avec base et boîte de dérivation.

With Base and Access Door .
With Terminal Block 4x1,5-16mmq.



H 4000mm	
● FA414006	852,00 €
● FA414033	852,00 €
H 5000mm	
● FA415006	978,00 €
● FA415033	978,00 €

Encastrable (+500 mm en dessous du sol)
Avec boîte de dérivation

In-Ground (+500 mm Root) With Access Door
With Terminal Block 4x1,5-16mmq

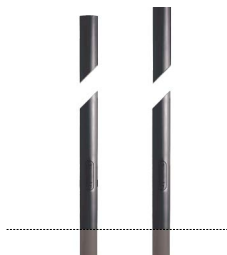

H 4000mm	
● FA414506	773,00 €
● FA414533	773,00 €
H 5000mm	
● FA415506	932,00 €
● FA415533	932,00 €

Projecteur mural ajustable / Adjustable Projector on Wall

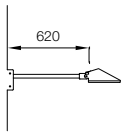



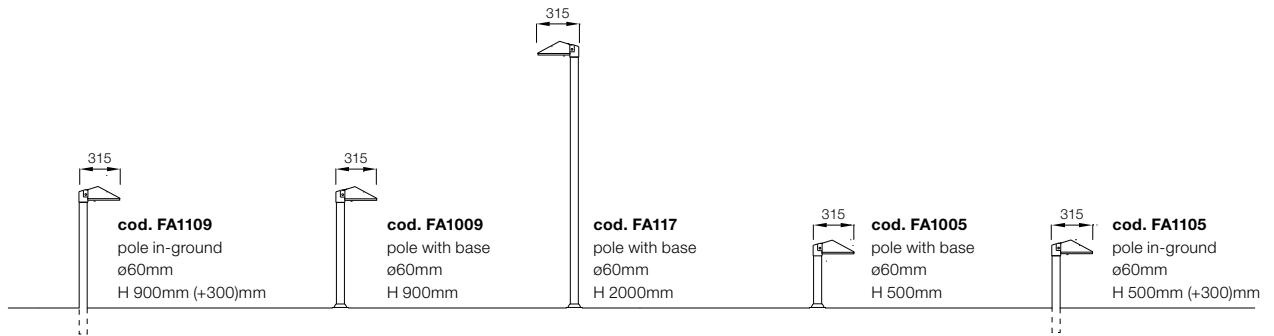

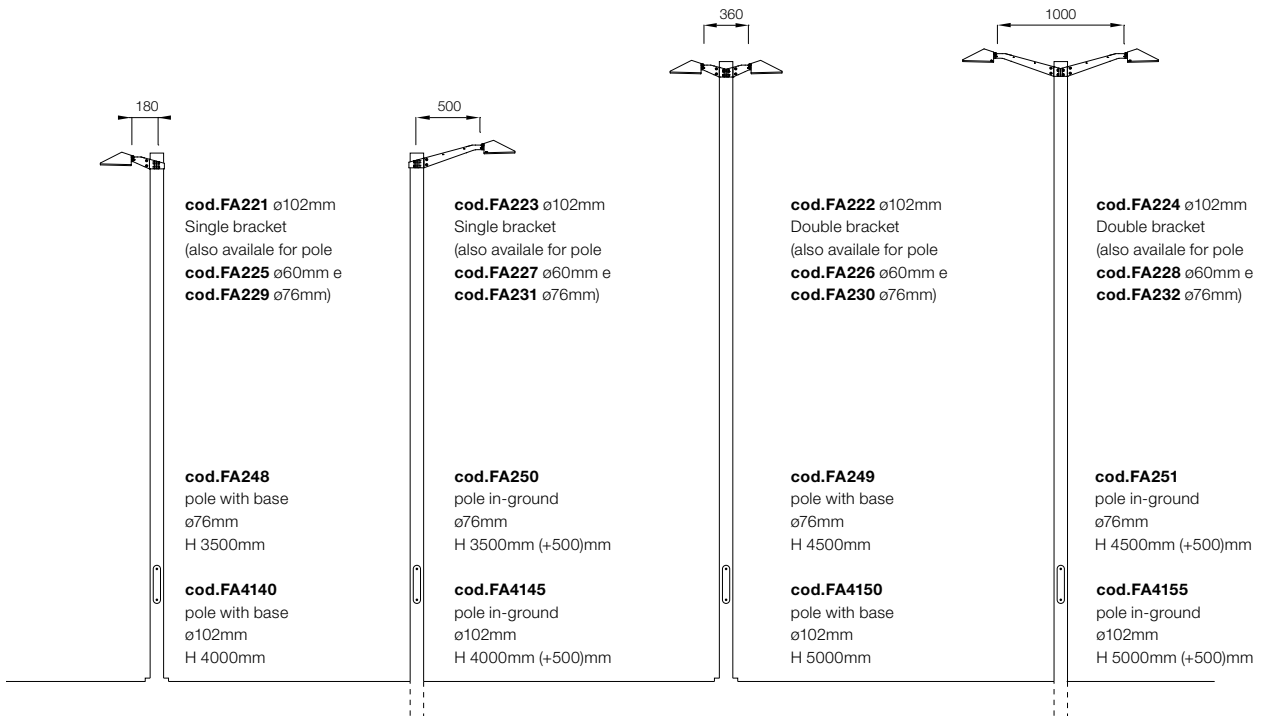

Projecteur avec support fixe non ajustable / Non-Adjustable Projector on Pole



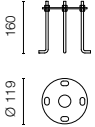

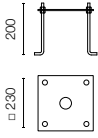
Projecteur avec support ajustable / Adjustable Projector on Pole

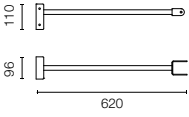

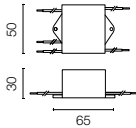
Franco 1: Accessoires / Accessories

Plaque de boulons.	Base plate with bolt.	H: 500 / 900 / 2000mm FA243	42,00 €		
Plaque de boulons.	Base plate with bolt.	H: 3500 / 4500mm with base FA116	97,00 €		
Bras 620mm.	Wall bracket 620mm.	○ FA8801 ● FA8806 ● FA8812 ● FA8818 ● FA8830 ● FA8833	140,00 € 140,00 € 140,00 € 140,00 € 140,00 € 140,00 €		
Dispositif de protection contre les surtensions. 275Vac. Courant de décharge maximal 10KA (8/20µs). Courant de fonctionnement maximal 5A. Adapté pour les connexions en séries. IP66.	Surge protection device. 275Vac. Maximum discharge current 10KA (8/20µs). Maximum operating current 5A. Suitable for series connection. IP66.	F990E00A000	116,00 €		

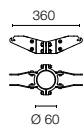
Franco 1 Ø 60mm

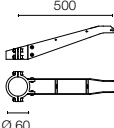
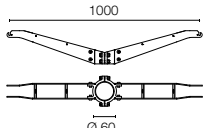
Bras individuel 180 mm. Pour support Ø 60 mm.	Single bracket 180mm. For pole Ø 60mm.	● FA22506 ● FA22533	153,00 € 153,00 €		
Bras double 180 mm. Pour support Ø 60 mm.	Double bracket 180mm. For pole Ø 60mm.	● FA22606 ● FA22633	281,00 € 281,00 €		
Bras individuel 500 mm. Pour support Ø 60 mm.	Single bracket 500mm. For pole Ø 60mm.	● FA22706 ● FA22733	198,00 € 198,00 €		
Bras double 500 mm. Pour support Ø 60 mm.	Double bracket 500mm. For pole Ø 60mm.	● FA22806 ● FA22833	336,00 € 336,00 €		

Franco 1 Ø 76mm

Bras individuel 180 mm.
Pour support Ø 76 mm.

Single bracket 180mm.
For pole Ø 76mm.

● FA22906
● FA22933

115,00 €
115,00 €

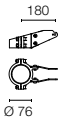

Bras double 180 mm.
Pour support Ø 76 mm.

Double bracket 180mm.
For pole Ø 76mm.

● FA23006
● FA23033

241,00 €
241,00 €

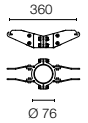

Bras individuel 500 mm.
Pour support Ø 76 mm.

Single bracket 500mm.
For pole Ø 76mm.

● FA23106
● FA23133

171,00 €
171,00 €

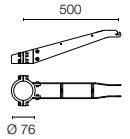

Bras double 500 mm.
Pour support Ø 76 mm.

Double bracket 500mm.
For pole Ø 76mm.

● FA23206
● FA23233

336,00 €
336,00 €

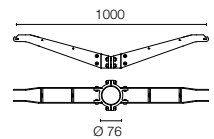

Franco 1 Ø 102mm

Bras individuel 180 mm.
Pour support Ø 102 mm.

Single bracket 180mm.
For pole Ø 102mm.

● FA22106
● FA22133

111,00 €
111,00 €

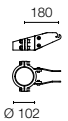

Bras double 180 mm.
Pour support Ø 102 mm.

Double bracket 180mm.
For pole Ø 102mm.

● FA22206
● FA22233

159,00 €
159,00 €

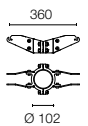

Bras individuel 500 mm.
Pour support Ø 102 mm.

Single bracket 500mm.
For pole Ø 102mm.

● FA22306
● FA22333

177,00 €
177,00 €

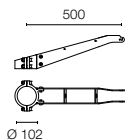

Bras double 500 mm.
Pour support Ø 102 mm.

Double bracket 500mm.
For pole Ø 102mm.

● FA22406
● FA22433

336,00 €
336,00 €

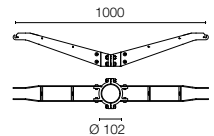

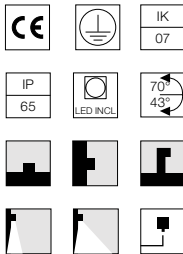
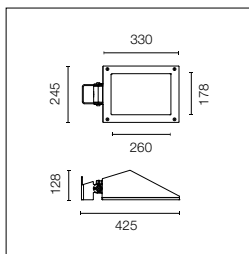

Source LED incluse. Source d'alimentation électrique intégrée 220-240V ON/OFF. Équerre de maintien graduée incluse. Équipé d'une gaine en métal M20x1,5 (pour des câbles de 7mm- ϕ <13mm) et d'un connecteur IP68. Pour garantir l'étanchéité de la gaine il est conseillé d'utiliser des câbles électriques flexibles et conçus pour l'extérieur. Accessoires optionnels : des poteaux et des bras pour une installation en tant que mât.

LED source included. Integrated electrical power supply 220-240V ON/OFF. Graduated fixing bracket included. Equipped with a M20x1.5 cable guide (for 7mm- ϕ <13mm cables) and IP68 connector. To ensure the tightness of the cable guide it's recommended to use flexible electric cables suitable for exterior use. Optional accessories: posts and arms for mast mounting.

Symmetric Optic

CoB Led: 43W - 5043 lm \neq OUTPUT 3143 lm - 2700K/CRI 80 - 220 \pm 240V / 43W - 5423 lm \neq OUTPUT 3380 lm - 3000K/CRI 80 - 220 \pm 240V / 43W - 5560 lm \neq OUTPUT 3465 lm - 4000K/CRI 80 - 220 \pm 240V

2700K

- FA962832301.A 535,00 €
- FA962832306.A 535,00 €
- FA962832312.A 535,00 €
- FA962832318.A 535,00 €
- FA962832330.A 535,00 €
- FA962832333.A 535,00 €

3000K

- FA962831301.A 535,00 €
- FA962831306.A 535,00 €
- FA962831312.A 535,00 €
- FA962831318.A 535,00 €
- FA962831330.A 535,00 €
- FA962831333.A 535,00 €

4000K

- FA962821301.A 535,00 €
- FA962821306.A 535,00 €
- FA962821312.A 535,00 €
- FA962821318.A 535,00 €
- FA962821330.A 535,00 €
- FA962821333.A 535,00 €

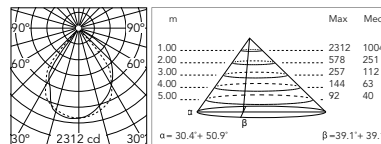

@ 3000K

Asymmetric Optic

CoB Led: 43W - 5043 lm \neq OUTPUT 2648 lm - 2700K/CRI 80 - 220 \pm 240V / 43W - 5423 lm \neq OUTPUT 2847 lm - 3000K/CRI 80 - 220 \pm 240V / 43W - 5560 lm \neq OUTPUT 2919 lm - 4000K/CRI 80 - 220 \pm 240V

2700K

- FA962832401.A 535,00 €
- FA962832406.A 535,00 €
- FA962832412.A 535,00 €
- FA962832418.A 535,00 €
- FA962832430.A 535,00 €
- FA962832433.A 535,00 €

3000K

- FA962831401.A 535,00 €
- FA962831406.A 535,00 €
- FA962831412.A 535,00 €
- FA962831418.A 535,00 €
- FA962831430.A 535,00 €
- FA962831433.A 535,00 €

4000K

- FA962821401.A 535,00 €
- FA962821406.A 535,00 €
- FA962821412.A 535,00 €
- FA962821418.A 535,00 €
- FA962821430.A 535,00 €
- FA962821433.A 535,00 €

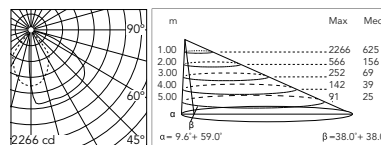

@ 3000K

Franco 2 / Ø 76mm - Poles

Avec base et boîte de dérivation.

With Base and Access Door.
With Terminal Block 4x1,5-16mmq.



H 3500mm

- FA24806 702,00 €
- FA24833 702,00 €

H 4500mm

- FA24906 852,00 €
- FA24933 852,00 €

Encastrable (+500 mm en dessous du sol)
Avec boîte de dérivation

In-Ground (+500 mm Root) With Access Door
With Terminal Block 4x1,5-16mmq

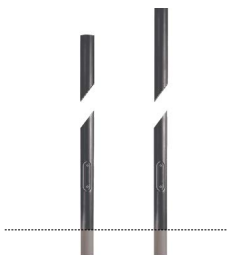

H 3500mm

- FA25006 644,00 €
- FA25033 644,00 €

H 4500mm

- FA25106 759,00 €
- FA25133 759,00 €

Franco 2 / Ø 102mm - Poles

Avec base et boîte de dérivation.

With Base and Access Door.
With Terminal Block 4x1,5-16mmq.



H 4000mm

- FA414006 852,00 €
- FA414033 852,00 €

H 5000mm

- FA415006 978,00 €
- FA415033 978,00 €

Encastrable (+500 mm en dessous du sol)
Avec boîte de dérivation

In-Ground (+500 mm Root) With Access Door
With Terminal Block 4x1,5-16mmq

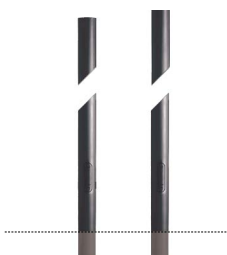

H 4000mm

- FA414506 773,00 €
- FA414533 773,00 €

H 5000mm

- FA415506 932,00 €
- FA415533 932,00 €

Installation scheme: Franco 2

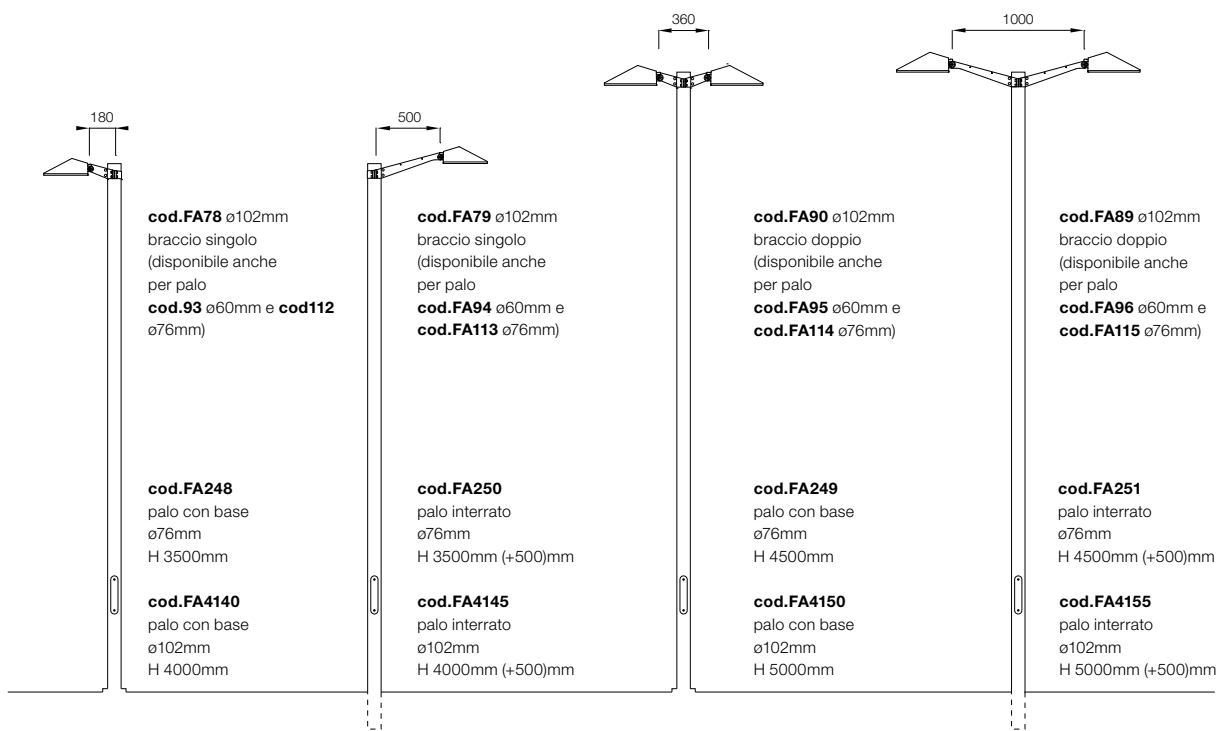

Franco 2: Accessoires / Accessories

Plaque de boulons.	Base plate with bolt.	FA116	97,00 €		
Dispositif de protection contre les surtensions. 275Vac. Courant de décharge maximal 10KA (8/20µs). Courant de fonctionnement maximal 5A. Adapté pour les connexions en séries. IP66.	Surge protection device. 275Vac. Maximum discharge current 10KA (8/20µs). Maximum operating current 5A. Suitable for series connection. IP66.	CoB LED F990E00A000	116,00 €		

Franco 2 Ø 60mm

Bras individuel 180 mm. Pour support Ø 60 mm.	Single bracket 180mm. For pole Ø 60mm.	● FA9306 ● FA9333	123,00 € 123,00 €		
Bras double 180 mm. Pour support Ø 60 mm.	Double bracket 180mm. For pole Ø 60mm.	● FA9506 ● FA9533	188,00 € 188,00 €		
Bras individuel 500 mm. Pour support Ø 60 mm.	Single bracket 500mm. For pole Ø 60mm.	● FA9406 ● FA9433	193,00 € 193,00 €		
Bras double 500 mm. Pour support Ø 60 mm.	Double bracket 500mm. For pole Ø 60mm.	● FA9606 ● FA9633	336,00 € 336,00 €		

Franco 2 Ø 76mm

Bras individuel 180 mm.
Pour support Ø 76 mm.

Single bracket 180mm.
For pole Ø 76mm.

● FA11206
● FA11233

90,00 €
90,00 €

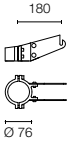

Bras double 180 mm.
Pour support Ø 76 mm.

Double bracket 180mm.
For pole Ø 76mm.

● FA11406
● FA11433

153,00 €
153,00 €

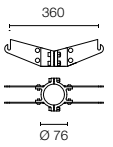

Bras individuel 500 mm.
Pour support Ø 76 mm.

Single bracket 500mm.
For pole Ø 76mm.

● FA11306
● FA11333

169,00 €
169,00 €

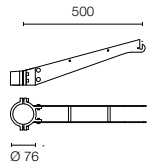

Bras double 500 mm.
Pour support Ø 76 mm.

Double bracket 500mm.
For pole Ø 76mm.

● FA11506
● FA11533

330,00 €
330,00 €

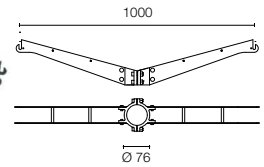

Franco 2 Ø 102mm

Bras individuel 180 mm.
Pour support Ø 102 mm.

Single bracket 180mm.
For pole Ø 102mm.

● FA7806
● FA7833

86,00 €
86,00 €

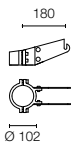

Bras double 180 mm.
Pour support Ø 102 mm.

Double bracket 180mm.
For pole Ø 102mm.

● FA9006
● FA9033

158,00 €
158,00 €

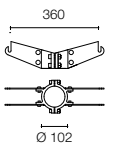

Bras individuel 500 mm.
Pour support Ø 102 mm.

Single bracket 500mm.
For pole Ø 102mm.

● FA7906
● FA7933

174,00 €
174,00 €

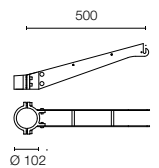

Bras double 500 mm.
Pour support Ø 102 mm.

Double bracket 500mm.
For pole Ø 102mm.

● FA8906
● FA8933

336,00 €
336,00 €

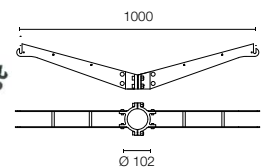

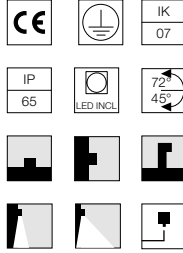
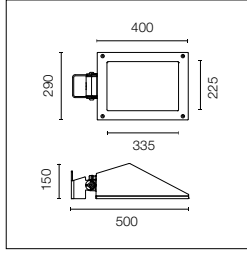

Source LED incluse. Source d'alimentation électrique intégrée 220-240V ON/OFF. Équerre de maintien graduée incluse. Équipé d'une gaine en métal M20x1,5 (pour des câbles de 7mmϕ<math><13\text{mm}</math>) et d'un connecteur IP68. Pour garantir l'étanchéité de la gaine il est conseillé d'utiliser des câbles électriques flexibles et conçus pour l'extérieur. Accessoires optionnels : des poteaux et des bras pour une installation en tant que mât.

LED source included. Integrated electrical power supply 220-240V ON/OFF. Graduated fixing bracket included. Equipped with a M20x1.5 cable guide (for 7mmϕ<math><13\text{mm}</math> cables) and IP68 connector. To ensure the tightness of the cable guide it's recommended to use flexible electric cables suitable for exterior use. Optional accessories: posts and arms for mast mounting.

Symmetric Optic

CoB Led: 52W - 5847 lm \neq OUTPUT 3757 lm - 2700K/CRI 80 - 220 \div 240V / 52W - 6287 lm \neq OUTPUT 4040 lm - 3000K/CRI 80 - 220 \div 240V / 52W - 6446 lm \neq OUTPUT 4142 lm - 4000K/CRI 80 - 220 \div 240V

2700K

- FA972842301.A 614,00 €
- FA972842306.A 614,00 €
- FA972842312.A 614,00 €
- FA972842318.A 614,00 €
- FA972842330.A 614,00 €
- FA972842333.A 614,00 €

3000K

- FA972851301.A 614,00 €
- FA972851306.A 614,00 €
- FA972851312.A 614,00 €
- FA972851318.A 614,00 €
- FA972851330.A 614,00 €
- FA972851333.A 614,00 €

4000K

- FA972841301.A 614,00 €
- FA972841306.A 614,00 €
- FA972841312.A 614,00 €
- FA972841318.A 614,00 €
- FA972841330.A 614,00 €
- FA972841333.A 614,00 €

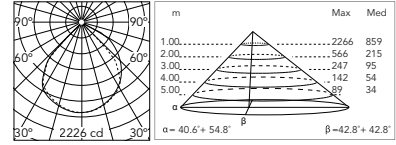

@ 3000K

Asymmetric Optic

CoB Led: 52W - 5847 lm \neq OUTPUT 3072 lm - 2700K/CRI 80 - 220 \div 240V / 52W - 6287 lm \neq OUTPUT 3303 lm - 3000K/CRI 80 - 220 \div 240V / 52W - 6446 lm \neq OUTPUT 3386 lm - 4000K/CRI 80 - 220 \div 240V

2700K

- FA942842401.A 614,00 €
- FA942842406.A 614,00 €
- FA942842412.A 614,00 €
- FA942842418.A 614,00 €
- FA942842430.A 614,00 €
- FA942842433.A 614,00 €

3000K

- FA942851401.A 614,00 €
- FA942851406.A 614,00 €
- FA942851412.A 614,00 €
- FA942851418.A 614,00 €
- FA942851430.A 614,00 €
- FA942851433.A 614,00 €

4000K

- FA972841401.A 614,00 €
- FA972841406.A 614,00 €
- FA972841412.A 614,00 €
- FA972841418.A 614,00 €
- FA972841430.A 614,00 €
- FA972841433.A 614,00 €

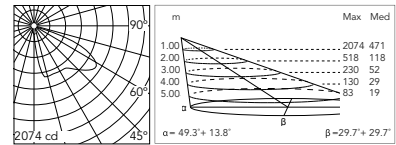

@ 3000K

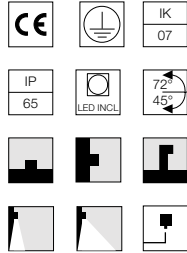
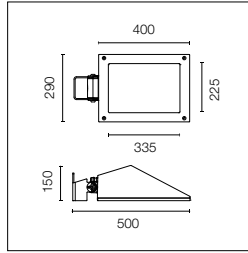

Source LED incluse. Source d'alimentation électrique intégrée 220-240V ON/OFF. Équerre de maintien graduée incluse. Équipé d'une gaine en métal M20x1,5 (pour des câbles de 7mm\varnothing<math><13\text{mm}</math>) et d'un connecteur IP68. Pour garantir l'étanchéité de la gaine il est conseillé d'utiliser des câbles électriques flexibles et conçus pour l'extérieur. Accessoires optionnels : des poteaux et des bras pour une installation en tant que mât.

LED source included. Integrated electrical power supply 220-240V ON/OFF. Graduated fixing bracket included. Equipped with a M20x1.5 cable guide (for 7mm\varnothing<math><13\text{mm}</math>) and IP68 connector. To ensure the tightness of the cable guide it's recommended to use flexible electric cables suitable for exterior use. Optional accessories: posts and arms for mast mounting.

Asymmetric Optic

Power Led: 43W - 5775 lm \neq OUTPUT 3676 lm - 2700K/CRI 80 - 220÷240V / 43W - 5589 lm \neq OUTPUT 3939 lm - 3000K/CRI 80 - 220÷240V / 43W - 5216 lm \neq OUTPUT 4070 lm - 4000K/CRI 80 - 220÷240V

2700K

Non Dimmable

- FA972472301 762,00 €
- FA972472306 762,00 €
- FA972472312 762,00 €
- FA972472318 762,00 €
- FA972472330 762,00 €
- FA972472333 762,00 €
- 1-10V
- FA972472301-310 839,00 €
- FA972472306-310 839,00 €
- FA972472312-310 839,00 €
- FA972472318-310 839,00 €
- FA972472330-310 839,00 €
- FA972472333-310 839,00 €
- Dali
- FA972472301-300 860,00 €
- FA972472306-300 860,00 €
- FA972472312-300 860,00 €
- FA972472318-300 860,00 €
- FA972472330-300 860,00 €
- FA972472333-300 860,00 €

3000K

Non Dimmable

- FA972481301 762,00 €
- FA972481306 762,00 €
- FA972481312 762,00 €
- FA972481318 762,00 €
- FA972481330 762,00 €
- FA972481333 762,00 €
- 1-10V
- FA972481301-310 839,00 €
- FA972481306-310 839,00 €
- FA972481312-310 839,00 €
- FA972481318-310 839,00 €
- FA972481330-310 839,00 €
- FA972481333-310 839,00 €
- Dali
- FA972481301-300 860,00 €
- FA972481306-300 860,00 €
- FA972481312-300 860,00 €
- FA972481318-300 860,00 €
- FA972481330-300 860,00 €
- FA972481333-300 860,00 €

4000K

Non Dimmable

- FA972471301.A 762,00 €
- FA972471306.A 762,00 €
- FA972471312.A 762,00 €
- FA972471318.A 762,00 €
- FA972471330.A 762,00 €
- FA972471333.A 762,00 €
- 1-10V
- FA972471301-310.A 839,00 €
- FA972471306-310.A 839,00 €
- FA972471312-310.A 839,00 €
- FA972471318-310.A 839,00 €
- FA972471330-310.A 839,00 €
- FA972471333-310.A 839,00 €
- Dali
- FA972471301-300.A 860,00 €
- FA972471306-300.A 860,00 €
- FA972471312-300.A 860,00 €
- FA972471318-300.A 860,00 €
- FA972471330-300.A 860,00 €
- FA972471333-300.A 860,00 €

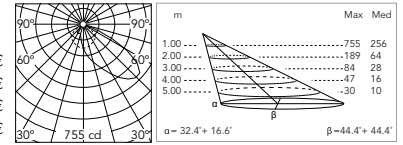

@ 3000K

Street Light Optic

Power Led: 43W - 5775 lm \neq OUTPUT 3130 lm - 2700K/CRI 80 - 220÷240V / 43W - 5589 lm \neq OUTPUT 3354 lm - 3000K/CRI 80 - 220÷240V / 43W - 5216 lm \neq OUTPUT 3466 lm - 4000K/CRI 80 - 220÷240V

2700K

Non Dimmable

- FA972472401 762,00 €
- FA972472406 762,00 €
- FA972472412 762,00 €
- FA972472418 762,00 €
- FA972472430 762,00 €
- FA972472433 762,00 €
- 1-10V
- FA972472401-310 839,00 €
- FA972472406-310 839,00 €
- FA972472412-310 839,00 €
- FA972472418-310 839,00 €
- FA972472430-310 839,00 €
- FA972472433-310 839,00 €
- Dali
- FA972472401-300 860,00 €
- FA972472406-300 860,00 €
- FA972472412-300 860,00 €
- FA972472418-300 860,00 €
- FA972472430-300 860,00 €
- FA972472433-300 860,00 €

3000K

Non Dimmable

- FA972481401 762,00 €
- FA972481406 762,00 €
- FA972481412 762,00 €
- FA972481418 762,00 €
- FA972481430 762,00 €
- FA972481433 762,00 €
- 1-10V
- FA972481401-310 839,00 €
- FA972481406-310 839,00 €
- FA972481412-310 839,00 €
- FA972481418-310 839,00 €
- FA972481430-310 839,00 €
- FA972481433-310 839,00 €
- Dali
- FA972481401-300 860,00 €
- FA972481406-300 860,00 €
- FA972481412-300 860,00 €
- FA972481418-300 860,00 €
- FA972481430-300 860,00 €
- FA972481433-300 860,00 €

4000K

Non Dimmable

- FA972471401.A 762,00 €
- FA972471406.A 762,00 €
- FA972471412.A 762,00 €
- FA972471418.A 762,00 €
- FA972471430.A 762,00 €
- FA972471433.A 762,00 €
- 1-10V
- FA972471401-310.A 839,00 €
- FA972471406-310.A 839,00 €
- FA972471412-310.A 839,00 €
- FA972471418-310.A 839,00 €
- FA972471430-310.A 839,00 €
- FA972471433-310.A 839,00 €
- Dali
- FA972471401-300.A 860,00 €
- FA972471406-300.A 860,00 €
- FA972471412-300.A 860,00 €
- FA972471418-300.A 860,00 €
- FA972471430-300.A 860,00 €
- FA972471433-300.A 860,00 €

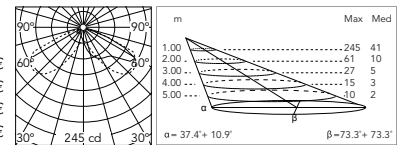

@ 3000K

Franco 3 / Ø 76mm - Poles

Avec base et boîte de dérivation.

With Base and Access Door.
With Terminal Block 4x1,5-16mmq.



H 3500mm

- FA24806 702,00 €
- FA24833 702,00 €

H 4500mm

- FA24906 852,00 €
- FA24933 852,00 €

Encastrable (+500 mm en dessous du sol)
Avec boîte de dérivation

In-Ground (+500 mm Root) With Access Door
With Terminal Block 4x1,5-16mmq



H 3500mm

- FA25006 644,00 €
- FA25033 644,00 €

H 4500mm

- FA25106 759,00 €
- FA25133 759,00 €

Franco 3 / Ø 102mm - Poles

Avec base et boîte de dérivation.

With Base and Access Door .
With Terminal Block 4x1,5-16mmq.



H 4000mm

- FA414006 852,00 €
- FA414033 852,00 €

H 5000mm

- FA415006 978,00 €
- FA415033 978,00 €

Encastrable (+500 mm en dessous du sol)
Avec boîte de dérivation

In-Ground (+500 mm Root) With Access Door
With Terminal Block 4x1,5-16mmq

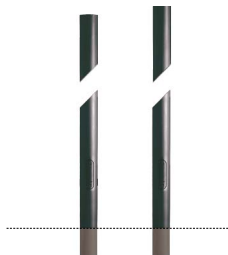

H 4000mm

- FA414506 773,00 €
- FA414533 773,00 €

H 5000mm

- FA415506 932,00 €
- FA415533 932,00 €

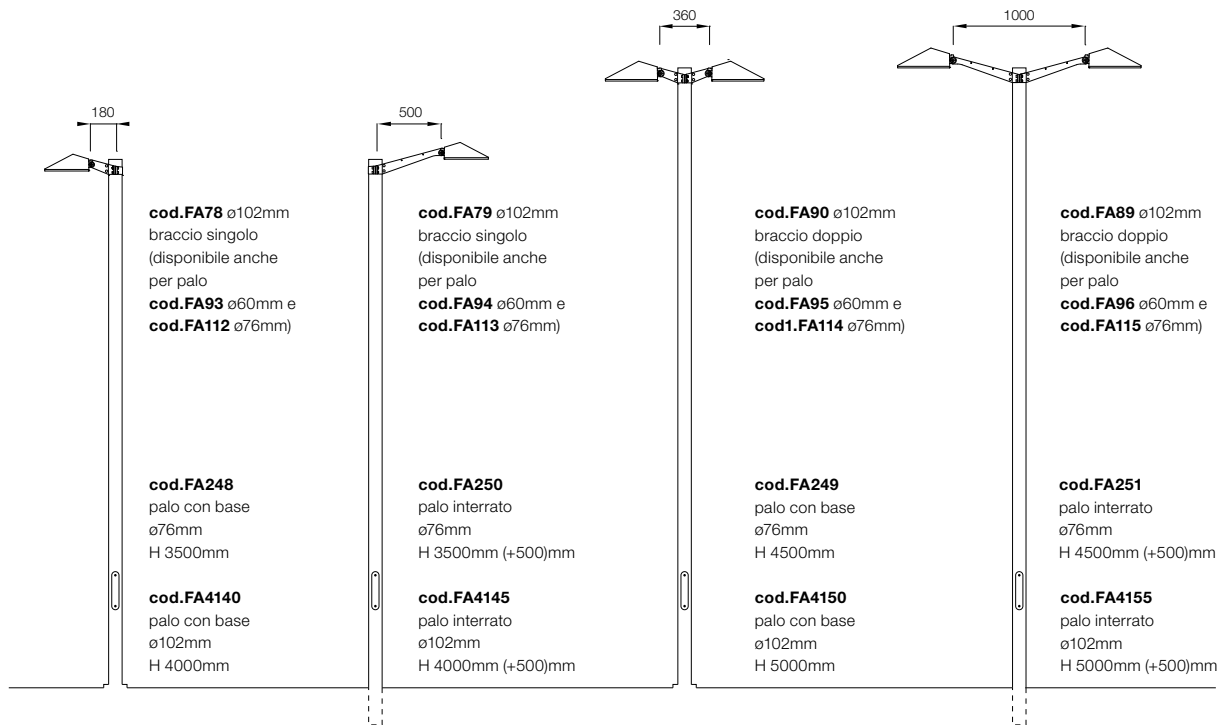







Franco 3: Accessoires / Accessories

Plaque de boulons.	Base plate with bolt.	FA116	97,00 €		
Dispositif de protection contre les surtensions. 275Vac. Courant de décharge maximal 10KA (8/20µs). Courant de fonctionnement maximal 5A. Adapté pour les connexions en séries. IP66.	Surge protection device. 275Vac. Maximum discharge current 10KA (8/20µs). Maximum operating current 5A. Suitable for series connection. IP66.	CoB LED / Power LED F990E00A000	116,00 €		

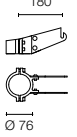
Franco 3 Ø 60mm

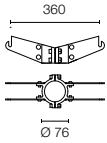
Bras individuel 180 mm. Pour support Ø 60 mm.	Single bracket 180mm. For pole Ø 60mm.	● FA9306 ● FA9333	123,00 € 123,00 €		
Bras double 180 mm. Pour support Ø 60 mm.	Double bracket 180mm. For pole Ø 60mm.	● FA9506 ● FA9533	188,00 € 188,00 €		
Bras individuel 500 mm. Pour support Ø 60 mm.	Single bracket 500mm. For pole Ø 60mm.	● FA9406 ● FA9433	193,00 € 193,00 €		
Bras double 500 mm. Pour support Ø 60 mm.	Double bracket 500mm. For pole Ø 60mm.	● FA9606 ● FA9633	336,00 € 336,00 €		

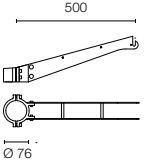
Franco 3 Ø 76mm

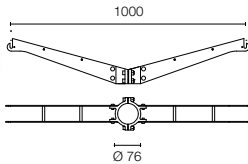
Bras individuel 180 mm. Pour support Ø 76 mm.	Single bracket 180mm. For pole Ø 76mm.	● FA11206 ● FA11233	90,00 € 90,00 €		
Bras double 180 mm. Pour support Ø 76 mm.	Double bracket 180mm. For pole Ø 76mm.	● FA11406 ● FA11433	153,00 € 153,00 €		
Bras individuel 500 mm. Pour support Ø 76 mm.	Single bracket 500mm. For pole Ø 76mm.	● FA11306 ● FA11333	169,00 € 169,00 €		
Bras double 500 mm. Pour support Ø 76 mm.	Double bracket 500mm. For pole Ø 76mm.	● FA11506 ● FA11533	330,00 € 330,00 €		

Franco 3 Ø 102mm

Bras individuel 180 mm. Pour support Ø 102 mm.	Single bracket 180mm. For pole Ø 102mm.	● FA7806 ● FA7833	86,00 € 86,00 €		
Bras double 180 mm. Pour support Ø 102 mm.	Double bracket 180mm. For pole Ø 102mm.	● FA9006 ● FA9033	158,00 € 158,00 €		
Bras individuel 500 mm. Pour support Ø 102 mm.	Single bracket 500mm. For pole Ø 102mm.	● FA7906 ● FA7933	174,00 € 174,00 €		
Bras double 500 mm. Pour support Ø 102 mm.	Double bracket 500mm. For pole Ø 102mm.	● FA8906 ● FA8933	336,00 € 336,00 €		

Perseo





Perseo

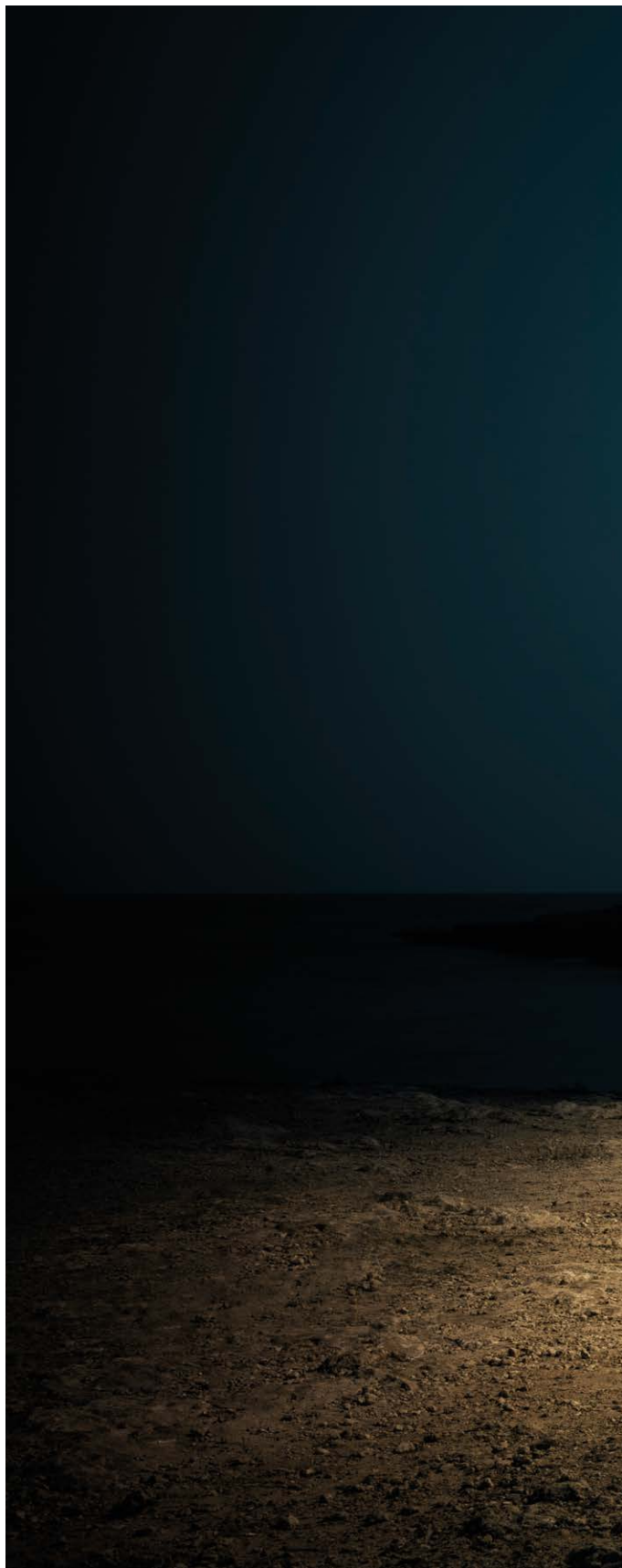



Famille / Family

Perseo 1



Power Led

up to 7W
up to 373 lm - 2700K/CRI 80
up to 401 lm - 3000K/CRI 80
up to 427 lm - 4000K/CRI 80
[2200K available on request.](#)

Mid-Power Led

up to 9W
up to 435 lm - 2700K/CRI 80
up to 468 lm - 3000K/CRI 80
up to 491 lm - 4000K/CRI 80

Perseo 2



Power Led

up to 12W
up to 866 lm - 2700K/CRI 80
up to 963 lm - 3000K/CRI 80
up to 984 lm - 4000K/CRI 80
[2200K available on request.](#)

Mid-Power Led

up to 11W
up to 580 lm - 2700K/CRI 80
up to 624 lm - 3000K/CRI 80
up to 655 lm - 4000K/CRI 80

Perseo 3



Power Led

up to 20W
up to 1559 lm - 2700K/CRI 80
up to 1732 lm - 3000K/CRI 80
up to 1771 lm - 4000K/CRI 80
[2200K available on request.](#)

Perseo 4



Power Led

up to 53W
up to 3989 lm - 2700K/CRI 80
up to 4332 lm - 3000K/CRI 80
up to 4533 lm - 4000K/CRI 80
[2200K available on request.](#)

RGB - Power Led

up to 40W + 220-240V
DMX interface.

Finitions / Colours



01 White

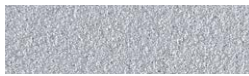

06 Grey



12 Forest Green



18 Deep Brown



30 Black



33 Anthracite

Famille complète de luminaires de projection ajustable, avec source LED, conçus pour des installations au mur, support pour mât, au plafond et au sol, à l'aide d'un clou métallique à commander séparément. Disponibles en quatre tailles et avec différentes optiques pour chaque taille. Ils incluent des optiques pour une utilisation en milieu urbain. Structure en aluminium moulé sous pression EN AB-47100 (à faible teneur en cuivre) et réflecteur en aluminium extra-pur. Diffuseur en verre extra-clair ou dépoli avec un bord sérigraphié, fixé au cadre par un système d'encollage robotisé. Disponibles en différentes finitions avec un revêtement à poudre double couche et une surface traitée par procédé de conversion chimique pour garantir une haute résistance à la corrosion. Équerre de maintien en acier inoxydable AISI 316L avec la même finition que la structure du luminaire.

Perseo 1 / Perseo 2

Luminaires de projection ajustable, conçus pour être installés au mur, au plafond ou au sol. Disponibles en trois ouvertures du faisceau lumineux : étroite, moyenne (verre transparent) et diffuse (verre dépoli). Équipés d'un câble sortant en néoprène et d'un kit avec des connecteurs sertissables et des gaines thermorétractables adhésives qui garantissent l'étanchéité de la connexion. L'équerre de maintien en acier inoxydable AISI316L permet une orientation d'environ 180° sur l'axe vertical. Accessoires optionnels complétant la gamme : piquet de terre ; pieds pour installation en tant que borne ; bras sortants du mur pour l'éclairage de panneaux. Des connecteurs IP68 sont inclus dans les pieds et bras pour garantir un câblage facile et sécurisé.

Perseo 3 / Perseo 4

Luminaires de projection ajustable, conçus pour être installés au mur, sur un poteau en tant que mât, au plafond ou au sol. Disponibles avec quatre ouvertures du faisceau lumineux : étroite, moyenne, asymétrique et des optiques urbaines. Équipés d'une gaine en métal. Pour garantir l'étanchéité de la gaine il est conseillé d'utiliser des câbles électriques flexibles et conçus pour l'extérieur. Équerre de maintien en acier inoxydable AISI316L, graduée pour garantir un ajustement précis de l'unité d'émission et une orientation d'environ 150° sur l'axe vertical. La gamme est complétée par des accessoires optionnels : des pieds pour une installation en tant que borne ; des bras pour mur, idéaux pour un éclairage à distance de panneaux (des connecteurs IP68 sont inclus dans les pieds et bras pour garantir un câblage facile et sécurisé) ; une série complète de pieds cylindriques, en plusieurs diamètres et hauteurs, à encastrer au sol ou à fixer à l'aide de plaques d'ancrage et des tire-fonds ; des bras individuels et doubles en deux longueurs, pour des poteaux de plusieurs diamètres ; viseur wall-washer et couvercle protecteur anti-vandalisme. Le modèle Perseo 4 est disponible en version RGB pour créer des scénographies avec des lumières de différentes couleurs.

Complete family of tiltable projection luminaires with LED source, designed for wall, post, ceiling and ground mounting with a metal nail that needs to be ordered separately. Available in four dimensions and with different light beams for every dimension, including optics for urban uses. Die cast aluminum body EN AB-47100 (with low copper content) and super pure aluminum reflector. Extraclear or frosted glass diffuser with silkscreen edge, attached to the frame with a robotic gluing system. Available in different finishes, with double-layered powder coating and chemical conversion surface treatment to ensure high corrosion resistance. AISI 316L stainless steel fixing bracket with the same finish as the luminaire body.

Perseo 1 / Perseo 2

Tiltable projection luminaires for wall, ceiling, and ground mounting. Three beam angles available: slim, medium (transparent glass) and diffused (frosted glass). Equipped with a protruding section of neoprene cable and a kit with crimpable connectors and adhesive heat-shrinkable sleeves that guarantee the tightness of the connection. The AISI 316L stainless steel fixing bracket allows for a tilting of approx. 180° on the vertical axis. The range is completed with the following optional accessories: ground spike; feet to install the luminaire as a bollard; and protruding arms for sign lighting. The feet and arms include IP68 connectors to guarantee an easy and safe cabling.

Perseo 3 / Perseo 4

Tiltable projection luminaires for wall, post, ceiling, and ground mounting. Four beam angles available: slim, medium, asymmetrical, and urban optics. Equipped with a metal cable guide. To ensure the tightness of the cable guide it's recommended to use flexible electric cables suitable for exterior use. AISI316L stainless steel fixing bracket, graduated to guarantee precision in the adjustment of the emission unit and a tilting of approx. 150° on the vertical axis. The range is completed with the following optional accessories: feet to install the luminaire as a bollard; arms for wall mounting, suitable for sign lighting at a distance (the feet and arms include IP68 connectors for an easy and safe cabling); a complete series of cylinder feet in different diameters and heights to be ground recessed or fixed with anchor plates and lag screws; single and double arms in two lengths for posts with different diameters, wall-washer visor and anti-vandalism protection lid. The Perseo 4 model is completed with the RGB version to create sceneries with colored light.

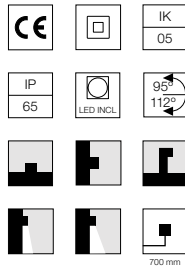
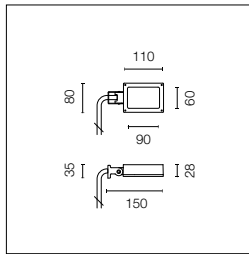

Source LED incluse. Source d'alimentation électrique intégrée 100-240V ON/OFF. Équerre de maintien incluse. Équipé d'un câble sortant de 700 mm en néoprène, et d'un kit avec des connecteurs sertissables et des gaines thermorétractables adhésives qui garantissent l'étanchéité de la connexion. Accessoires optionnels : piquet de terre ; pieds pour une installation au sol et bras pour une connexion au mur (connecteur IP68 inclus). Verre transparent extra-clair. Verre dépoli.

LED source included. Integrated electrical power supply 100-240V ON- OFF. Fixing bracket included. Equipped with a 700 mm protruding section of neoprene cable and a kit with crimpable connectors and adhesive heat-shrinkable sleeves that guarantee the tightness of the connection. Optional accessories: ground spike; feet for ground mounting and arms for wall mounting (IP68 connector included). Extraclear transparent glass. Verre dépoli.

2200K disponible sur demande.

2200K available on request.

Optic Narrow Spot 8°

Power LED: 7W - 398 lm ≠ OUTPUT 373 lm - 2700K/CRI 80 - 100-240V / 7W - 428 lm ≠ OUTPUT 401 lm - 3000K/CRI 80 - 100-240V / 7W - 456 lm ≠ OUTPUT 427 lm - 4000K/CRI 80 - 100-240V

2700K

- FA52514001.A 229,00 €
- FA52514006.A 229,00 €
- FA52514012.A 229,00 €
- FA52514018.A 229,00 €
- FA52514030.A 229,00 €
- FA52514033.A 229,00 €

3000K

- FA52501301.A 229,00 €
- FA52501306.A 229,00 €
- FA52501312.A 229,00 €
- FA52501318.A 229,00 €
- FA52501330.A 229,00 €
- FA52501333.A 229,00 €

4000K

- FA52501201.A 229,00 €
- FA52501206.A 229,00 €
- FA52501212.A 229,00 €
- FA52501218.A 229,00 €
- FA52501230.A 229,00 €
- FA52501233.A 229,00 €

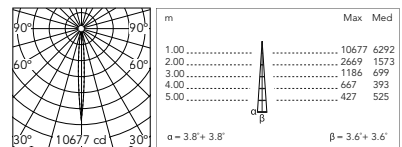

@ 4000K

Optic Medium 40°

Power LED: 7W - 398 lm ≠ OUTPUT 332 lm - 2700K/CRI 80 - 100-240V / 7W - 428 lm ≠ OUTPUT 357 lm - 3000K/CRI 80 - 100-240V / 7W - 456 lm ≠ OUTPUT 381 lm - 4000K/CRI 80 - 100-240V

2700K

- FA52514201.A 229,00 €
- FA52514206.A 229,00 €
- FA52514212.A 229,00 €
- FA52514218.A 229,00 €
- FA52514230.A 229,00 €
- FA52514233.A 229,00 €

3000K

- FA52502301.A 229,00 €
- FA52502306.A 229,00 €
- FA52502312.A 229,00 €
- FA52502318.A 229,00 €
- FA52502330.A 229,00 €
- FA52502333.A 229,00 €

4000K

- FA52502201.A 229,00 €
- FA52502206.A 229,00 €
- FA52502212.A 229,00 €
- FA52502218.A 229,00 €
- FA52502230.A 229,00 €
- FA52502233.A 229,00 €

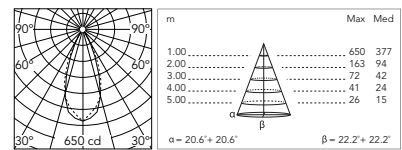

@ 4000K

Perseo 1 Opal

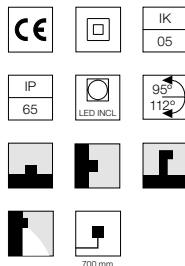
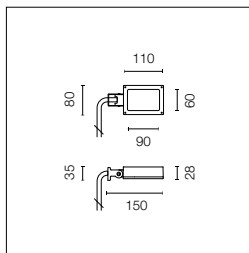

Source LED incluse. Source d'alimentation électrique intégrée 100-240V ON/OFF. Équerre de maintien incluse. Équipé d'un câble sortant de 700 mm en néoprène, et d'un kit avec des connecteurs sertissables et des gaines thermorétractables adhésives qui garantissent l'étanchéité de la connexion. Accessoires optionnels : piquet de terre ; pieds pour une installation au sol et bras pour une connexion au mur (connecteur IP68 inclus). Verre dépoli.

LED source included. Integrated electrical power supply 100-240V ON- OFF. Fixing bracket included. Equipped with a 700 mm protruding section of neoprene cable and a kit with crimpable connectors and adhesive heat-shrinkable sleeves that guarantee the tightness of the connection. Optional accessories: ground spike; feet for ground mounting and arms for wall mounting (IP68 connector included). Frosted glass.

Diffused Light

Mid-Power LED: 9W - 836 lm ≠ OUTPUT 435 lm - 2700K/CRI 80 - 100-240V / 9W - 899 lm ≠ OUTPUT 468 lm - 3000K/CRI 80 - 100-240V / 9W - 943 lm ≠ OUTPUT 491 lm - 4000K/CRI 80 - 100-240V

2700K

- FA52514401.A 199,00 €
- FA52514406.A 199,00 €
- FA52514412.A 199,00 €
- FA52514418.A 199,00 €
- FA52514430.A 199,00 €
- FA52514433.A 199,00 €

3000K

- FA52500301.A 199,00 €
- FA52500306.A 199,00 €
- FA52500312.A 199,00 €
- FA52500318.A 199,00 €
- FA52500330.A 199,00 €
- FA52500333.A 199,00 €





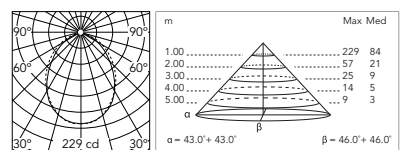

4000K

- FA52500201.A 199,00 €
- FA52500206.A 199,00 €
- FA52500212.A 199,00 €
- FA52500218.A 199,00 €
- FA52500230.A 199,00 €
- FA52500233.A 199,00 €

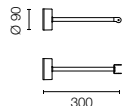

@ 4000K

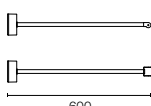
Perseo 1: Accessoires / Accessories

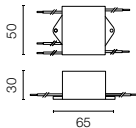
Pique pour la fixation au sol.	Ground spike.	FA136	34,00 €		
Bras / Support 300mm.	Wall bracket / Pole 300mm.	<ul style="list-style-type: none"> ○ FA15701 104,00 € ● FA15706 104,00 € ● FA15712 104,00 € ● FA15718 104,00 € ● FA15730 104,00 € ● FA15733 104,00 € 			
Bras / Support 600mm.	Wall bracket / Pole 600mm.	<ul style="list-style-type: none"> ○ FA15801 110,00 € ● FA15806 110,00 € ● FA15812 110,00 € ● FA15818 110,00 € ● FA15830 110,00 € ● FA15833 110,00 € 			
Dispositif de protection contre les surtensions. 275Vac. Courant de décharge maximal 10KA (8/20µs). Courant de fonctionnement maximal 5A. Adapté pour les connexions en séries. IP66.	Surge protection device. 275Vac. Maximum discharge current 10KA (8/20µs). Maximum operating current 5A. Suitable for series connection. IP66.	F990E00A000	116,00 €		

Installation scheme: Perseo 1

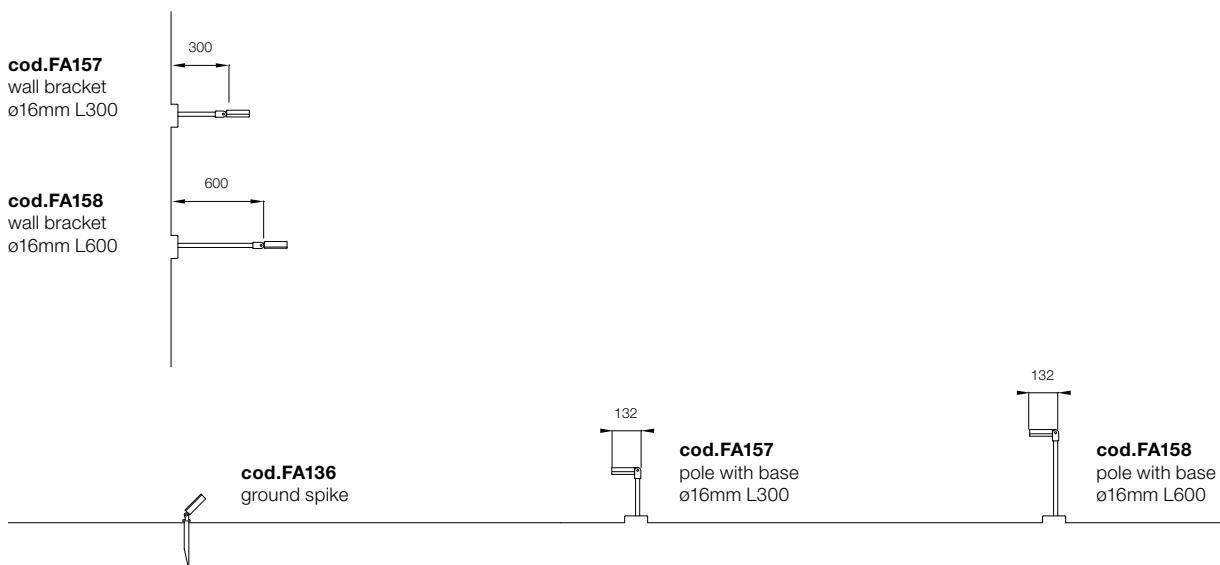

Perseo 2

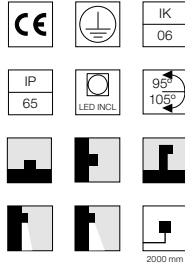
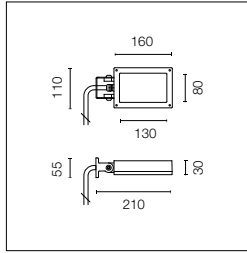

Source LED incluse. Source d'alimentation électrique intégrée 220-240V ON/OFF. Équerre de maintien incluse. Équipé d'un câble sortant de 700 mm en néoprène, et d'un kit avec des connecteurs sertissables et des gaines thermorétractables adhésives qui garantissent l'étanchéité de la connexion. Accessoires optionnels : piquet de terre ; pieds pour une installation au sol et bras pour une connexion au mur (connecteur IP68 inclus). Verre transparent extra-clair. Verre dépoli.

LED source included. Integrated electrical power supply 220-240V ON- OFF. Fixing bracket included. Equipped with a 700 mm protruding section of neoprene cable and a kit with crimpable connectors and adhesive heat-shrinkable sleeves that guarantee the tightness of the connection. Optional accessories: ground spike; feet for ground mounting and arms for wall mounting (IP68 connector included). Extraclear transparent glass. Frosted glass.

2200K disponible sur demande.

2200K available on request.

Optic Spot 13°

Power Led: 12W - 1256 lm ≠ OUTPUT 866 lm - 2700K/CRI 80 - 220-240V / 12W - 1395 lm ≠ OUTPUT 963 lm - 3000K/CRI 80 - 220-240V / 12W - 1465 lm ≠ OUTPUT 984 lm - 4000K/CRI 80 - 220-240V

2700K

○ FA52514601	308,00 €
● FA52514606	308,00 €
● FA52514612	308,00 €
● FA52514618	308,00 €
● FA52514630	308,00 €
● FA52514633	308,00 €

3000K

○ FA52504301	308,00 €
● FA52504306	308,00 €
● FA52504312	308,00 €
● FA52504318	308,00 €
● FA52504330	308,00 €
● FA52504333	308,00 €

4000K

○ FA52504201	308,00 €
● FA52504206	308,00 €
● FA52504212	308,00 €
● FA52504218	308,00 €
● FA52504230	308,00 €
● FA52504233	308,00 €

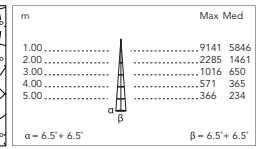
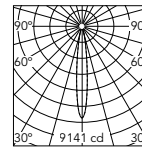

@ 4000K

Optic Medium 42°

Power Led: 12W - 1256 lm ≠ OUTPUT 745 lm - 2700K/CRI 80 - 220-240V / 12W - 1395 lm ≠ OUTPUT 828 lm - 3000K/CRI 80 - 220-240V / 12W - 1465 lm ≠ OUTPUT 846 lm - 4000K/CRI 80 - 220-240V

2700K

○ FA52514801	308,00 €
● FA52514806	308,00 €
● FA52514812	308,00 €
● FA52514818	308,00 €
● FA52514830	308,00 €
● FA52514833	308,00 €

3000K

○ FA52505301	308,00 €
● FA52505306	308,00 €
● FA52505312	308,00 €
● FA52505318	308,00 €
● FA52505330	308,00 €
● FA52505333	308,00 €

4000K

○ FA52505201	308,00 €
● FA52505206	308,00 €
● FA52505212	308,00 €
● FA52505218	308,00 €
● FA52505230	308,00 €
● FA52505233	308,00 €

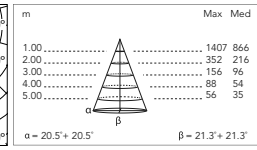
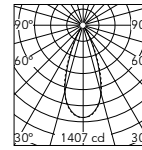

@ 4000K

Perseo 2 Opal

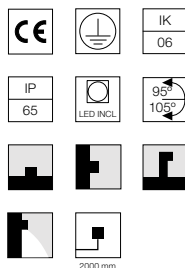
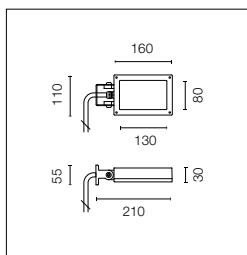

Source LED incluse. Source d'alimentation électrique intégrée 220-240V ON/OFF. Équerre de maintien incluse. Équipé d'un câble sortant de 700 mm en néoprène, et d'un kit avec des connecteurs sertissables et des gaines thermorétractables adhésives qui garantissent l'étanchéité de la connexion. Accessoires optionnels : piquet de terre ; pieds pour une installation au sol et bras pour une connexion au mur (connecteur IP68 inclus). Verre dépoli.

LED source included. Integrated electrical power supply 220-240V ON- OFF. Fixing bracket included. Equipped with a 700 mm protruding section of neoprene cable and a kit with crimpable connectors and adhesive heat-shrinkable sleeves that guarantee the tightness of the connection. Optional accessories: ground spike; feet for ground mounting and arms for wall mounting (IP68 connector included). Frosted glass.

Diffused Light

Mid-Power Led: 11W - 1114 lm ≠ OUTPUT 580 lm - 2700K/CRI 80 - 220-240V / 11W - 1198 lm ≠ OUTPUT 624 lm - 3000K/CRI 80 - 220-240V / 11W - 1258 lm ≠ OUTPUT 655 lm - 4000K/CRI 80 - 220-240V

2700K

○ FA52515001	229,00 €
● FA52515006	229,00 €
● FA52515012	229,00 €
● FA52515018	229,00 €
● FA52515030	229,00 €
● FA52515033	229,00 €

3000K

○ FA52503301	229,00 €
● FA52503306	229,00 €
● FA52503312	229,00 €
● FA52503318	229,00 €
● FA52503330	229,00 €
● FA52503333	229,00 €

4000K

○ FA52503201	229,00 €
● FA52503206	229,00 €
● FA52503212	229,00 €
● FA52503218	229,00 €
● FA52503230	229,00 €
● FA52503233	229,00 €

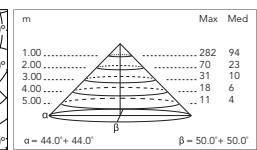
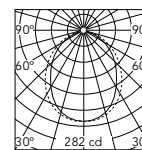

@ 4000K

Perseo 2 / Ø 48mm - Poles With Base



H 500mm

○ FA17701	85,00 €
● FA17706	85,00 €
● FA17712	85,00 €
● FA17718	85,00 €
● FA17730	85,00 €
● FA17733	85,00 €

H 800mm

○ FA17801	116,00 €
● FA17806	116,00 €
● FA17812	116,00 €
● FA17818	116,00 €
● FA17830	116,00 €
● FA17833	116,00 €

Perseo 2: Accessoires / Accessories

Pique pour la fixation au sol.

Ground spike.

FA136

34,00 €



Bras / Support 300mm.

Wall bracket / Pole 300mm.

○ FA16101	102,00 €
● FA16106	102,00 €
● FA16112	102,00 €
● FA16118	102,00 €
● FA16130	102,00 €
● FA16133	102,00 €

102,00 €



Bras / Support 600mm.

Wall bracket / Pole 600mm.

○ FA16201	111,00 €
● FA16206	111,00 €
● FA16212	111,00 €
● FA16218	111,00 €
● FA16230	111,00 €
● FA16233	111,00 €

111,00 €

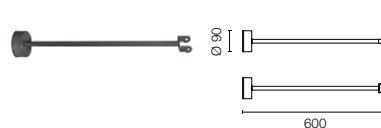

Plaque de boulons.

Base plate with bolt.

FA182

26,00 €

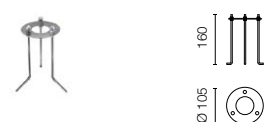

Dispositif de protection contre les surtensions. 275Vac. Courant de décharge maximal 10KA (8/20µs). Courant de fonctionnement maximal 5A. Adapté pour les connexions en série. IP66.

Surge protection device. 275Vac. Maximum discharge current 10KA (8/20µs). Maximum operating current 5A. Suitable for series connection. IP66.

F990E00A000

116,00 €

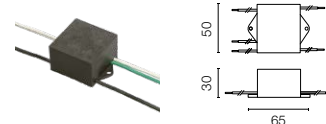

Installation scheme: Perseo 2

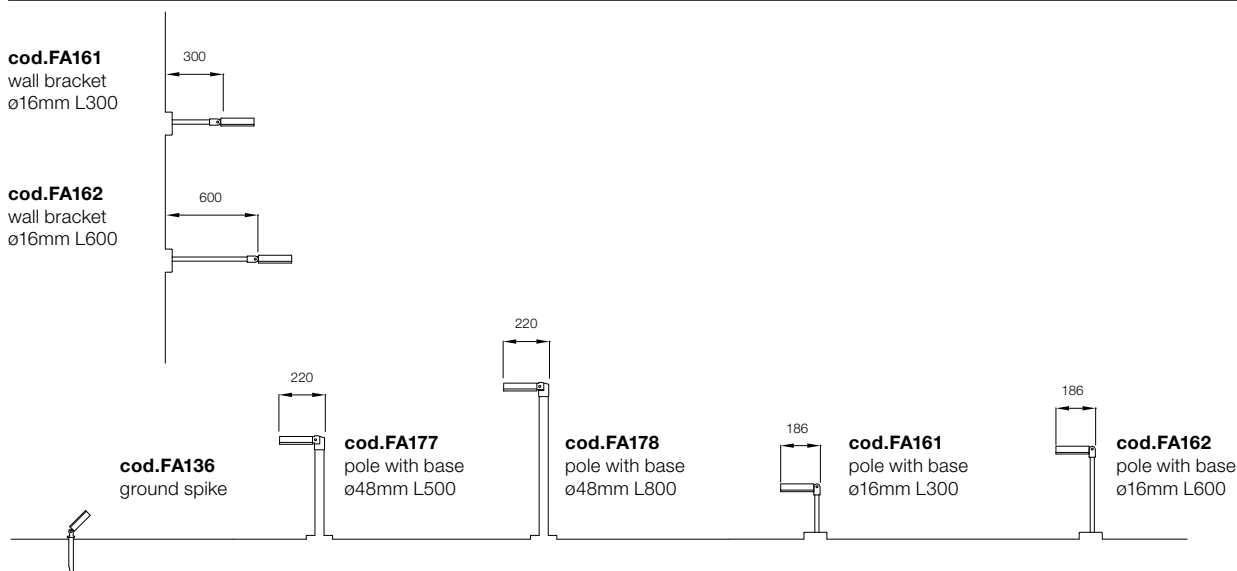

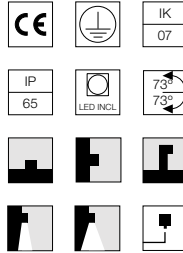
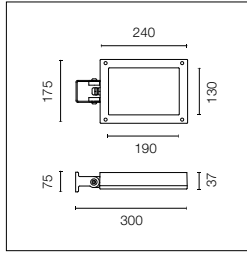

Source LED incluse. Source d'alimentation électrique intégrée 220-240V ON/OFF et intensité réglable entre 1 y 10V ou DALI. Équerre de maintien incluse. Équipé d'une gaine en métal M16x1,5 (pour des câbles de 4,5mmϕ<math><10\text{mm}</math>). Pour garantir l'étanchéité de la gaine il est conseillé d'utiliser des câbles électriques flexibles et conçus pour l'extérieur. Accessoires optionnels : bras sortant pour mur ; pieds et bras pour être installé en tant que mât ; viseur wall-washer et couvercle protecteur anti-vandalisme. Verre transparent.

LED source included. Integrated power supply 220-240V ON/OFF and dimmable 1-10V or DALI. Fixing bracket included. Equipped with a M16x1.5 cable guide (for 4.5mmϕ<math><10\text{mm}</math> cables) and IP68 connector. To ensure the tightness of the cable guide it's recommended to use flexible electric cables suitable for exterior use. Optional accessories: protruding arm for walls; feet and arms to install the luminaire on a mast; wall-washer visor and anti-vandalism protection lid. Extraclear transparent glass.

2200K disponible sur demande.

2200K available on request.

Optic Spot 11°

Power Led: 20W - 2232 lm ≠ OUTPUT 1559 lm - 2700K/CRI 80 - 220-240V / 20W - 2424 lm ≠ OUTPUT 1732 lm - 3000K/CRI 80 - 220-240V / 20W - 2536 lm ≠ OUTPUT 1771 lm - 4000K/CRI 80 - 220-240V

2700K

Non Dimmable	
○ FA52515201	533,00 €
● FA52515206	533,00 €
● FA52515212	533,00 €
● FA52515218	533,00 €
● FA52515230	533,00 €
● FA52515233	533,00 €
1-10V	
○ FA52515201-310	621,00 €
● FA52515206-310	621,00 €
● FA52515212-310	621,00 €
● FA52515218-310	621,00 €
● FA52515230-310	621,00 €
● FA52515233-310	621,00 €
Dali	
○ FA52515201-300	682,00 €
● FA52515206-300	682,00 €
● FA52515212-300	682,00 €
● FA52515218-300	682,00 €
● FA52515230-300	682,00 €
● FA52515233-300	682,00 €

3000K

Non Dimmable	
○ FA52509301	533,00 €
● FA52509306	533,00 €
● FA52509312	533,00 €
● FA52509318	533,00 €
● FA52509330	533,00 €
● FA52509333	533,00 €
1-10V	
○ FA52509301-310	621,00 €
● FA52509306-310	621,00 €
● FA52509312-310	621,00 €
● FA52509318-310	621,00 €
● FA52509330-310	621,00 €
● FA52509333-310	621,00 €
Dali	
○ FA52509301-300	682,00 €
● FA52509306-300	682,00 €
● FA52509312-300	682,00 €
● FA52509318-300	682,00 €
● FA52509330-300	682,00 €
● FA52509333-300	682,00 €

4000K

Non Dimmable	
○ FA52509201	533,00 €
● FA52509206	533,00 €
● FA52509212	533,00 €
● FA52509218	533,00 €
● FA52509230	533,00 €
● FA52509233	533,00 €
1-10V	
○ FA52509201-310	621,00 €
● FA52509206-310	621,00 €
● FA52509212-310	621,00 €
● FA52509218-310	621,00 €
● FA52509230-310	621,00 €
● FA52509233-310	621,00 €
Dali	
○ FA52509201-300	682,00 €
● FA52509206-300	682,00 €
● FA52509212-300	682,00 €
● FA52509218-300	682,00 €
● FA52509230-300	682,00 €
● FA52509233-300	682,00 €

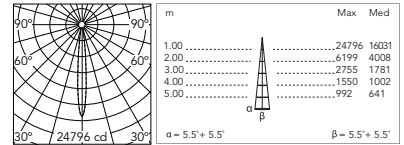

@ 4000K

Optic Medium 34°

Power Led: 20W - 2232 lm ≠ OUTPUT 1582 lm - 2700K/CRI 80 - 220-240V / 20W - 2424 lm ≠ OUTPUT 1757 lm - 3000K/CRI 80 - 220-240V / 20W - 2536 lm ≠ OUTPUT 1797 lm - 4000K/CRI 80 - 220-240V

2700K

Non Dimmable	
○ FA52515401	533,00 €
● FA52515406	533,00 €
● FA52515412	533,00 €
● FA52515418	533,00 €
● FA52515430	533,00 €
● FA52515433	533,00 €
1-10V	
○ FA52515401-310	621,00 €
● FA52515406-310	621,00 €
● FA52515412-310	621,00 €
● FA52515418-310	621,00 €
● FA52515430-310	621,00 €
● FA52515433-310	621,00 €
Dali	
○ FA52515401-300	682,00 €
● FA52515406-300	682,00 €
● FA52515412-300	682,00 €
● FA52515418-300	682,00 €
● FA52515430-300	682,00 €
● FA52515433-300	682,00 €

3000K

Non Dimmable	
○ FA52508301	533,00 €
● FA52508306	533,00 €
● FA52508312	533,00 €
● FA52508318	533,00 €
● FA52508330	533,00 €
● FA52508333	533,00 €
1-10V	
○ FA52508301-310	621,00 €
● FA52508306-310	621,00 €
● FA52508312-310	621,00 €
● FA52508318-310	621,00 €
● FA52508330-310	621,00 €
● FA52508333-310	621,00 €
Dali	
○ FA52508301-300	682,00 €
● FA52508306-300	682,00 €
● FA52508312-300	682,00 €
● FA52508318-300	682,00 €
● FA52508330-300	682,00 €
● FA52508333-300	682,00 €

4000K

Non Dimmable	
○ FA52508201	533,00 €
● FA52508206	533,00 €
● FA52508212	533,00 €
● FA52508218	533,00 €
● FA52508230	533,00 €
● FA52508233	533,00 €
1-10V	
○ FA52508201-310	621,00 €
● FA52508206-310	621,00 €
● FA52508212-310	621,00 €
● FA52508218-310	621,00 €
● FA52508230-310	621,00 €
● FA52508233-310	621,00 €
Dali	
○ FA52508201-300	682,00 €
● FA52508206-300	682,00 €
● FA52508212-300	682,00 €
● FA52508218-300	682,00 €
● FA52508230-300	682,00 €
● FA52508233-300	682,00 €

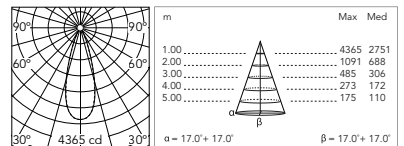

@ 4000K

Perseo 3 LED / Ø 48mm - Poles

Avec base / With Base



H 800mm

○ FA17901	114,00 €
● FA17906	114,00 €
● FA17912	114,00 €
● FA17918	114,00 €
● FA17930	114,00 €
● FA17933	114,00 €

Da Interrare (+300 mm Interrati)

Encastrable (+300 mm en dessous du sol)



H 2000mm

○ FA18001	115,00 €
● FA18006	115,00 €
● FA18012	115,00 €
● FA18018	115,00 €
● FA18030	115,00 €
● FA18033	115,00 €

Perseo 3 LED / Ø 76mm - Poles

Avec base et boîte de dérivation.

With Base and Access Door.
With Terminal Block 4x1,5-16mmq.



H 3500mm

● FA24806	702,00 €
● FA24833	702,00 €

H 4500mm

● FA24906	852,00 €
● FA24933	852,00 €

Encastrable (+500 mm en dessous du sol)

Avec boîte de dérivation

In-Ground (+500 mm Root) With Access Door
With Terminal Block 4x1,5-16mmq



H 3500mm

● FA25006	644,00 €
● FA25033	644,00 €

H 4500mm

● FA25106	759,00 €
● FA25133	759,00 €

Perseo 3 LED / Ø 102mm - Poles

Avec base et boîte de dérivation.

With Base and Access Door .
With Terminal Block 4x1,5-16mmq.



H 4000mm

● FA414006	852,00 €
● FA414033	852,00 €

H 5000mm

● FA415006	978,00 €
● FA415033	978,00 €

Encastrable (+500 mm en dessous du sol)

Avec boîte de dérivation

In-Ground (+500 mm Root) With Access Door
With Terminal Block 4x1,5-16mmq



H 4000mm

● FA414506	773,00 €
● FA414533	773,00 €

H 5000mm

● FA415506	932,00 €
● FA415533	932,00 €

Installation scheme: Perseo 3

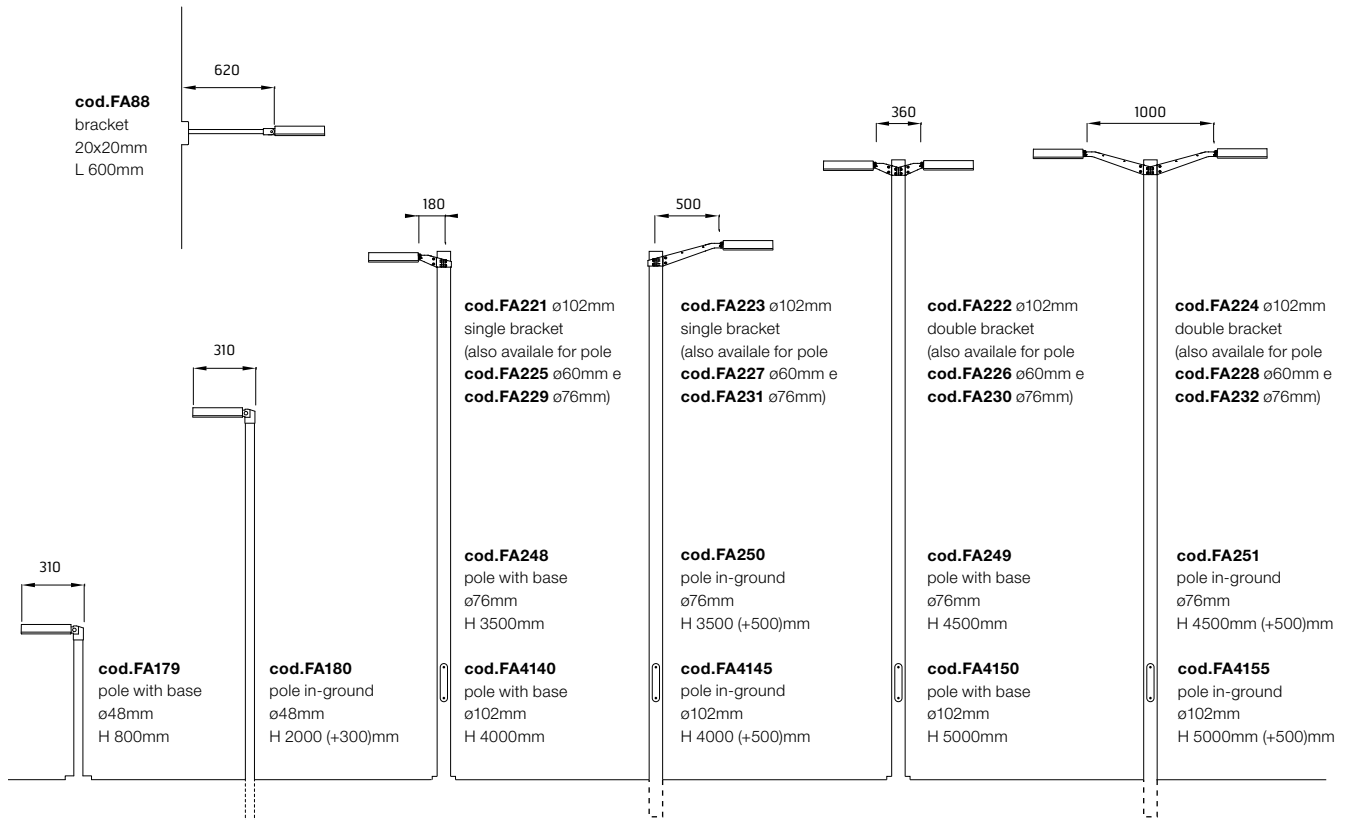

Perseo 3: Accessoires / Accessories



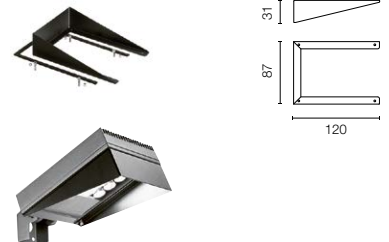

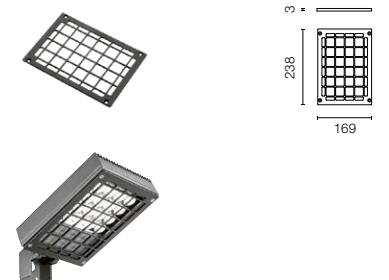

Viseur Wall-Washer Wall Washer Visor FA16530 77,00 €

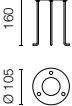

Couvercle extérieur anti-vandalisme Anti vandal louvre FA16630 78,00 €

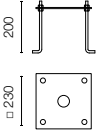

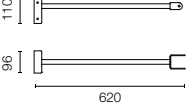
Perseo 3: Accessoires / Accessories

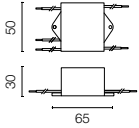
Plaque de boulons.	Base plate with bolt.	FA182	26,00 €		
Plaque de boulons.	Base plate with bolt.	FA116	97,00 €		
Bras 620 mm.	Wall bracket 620mm.	<ul style="list-style-type: none"> ○ FA8801 ● FA8806 ● FA8812 ● FA8818 ● FA8830 ● FA8833 	<ul style="list-style-type: none"> 140,00 € 140,00 € 140,00 € 140,00 € 140,00 € 140,00 € 		
Dispositif de protection contre les surtensions. 275Vac. Courant de décharge maximal 10KA (8/20µs). Courant de fonctionnement maximal 5A. Adapté pour les connexions en séries. IP66.	Surge protection device. 275Vac. Maximum discharge current 10KA (8/20µs). Maximum operating current 5A. Suitable for series connection. IP66.	F990E00A000	116,00 €		

Perseo 3 Ø 60mm

Bras individuel 180 mm. Pour support Ø 60 mm.	Single bracket 180mm. For pole Ø 60mm.	<ul style="list-style-type: none"> ● FA22506 ● FA22533 	<ul style="list-style-type: none"> 153,00 € 153,00 € 		
Bras double 180 mm. Pour support Ø 60 mm.	Double bracket 180mm. For pole Ø 60mm.	<ul style="list-style-type: none"> ● FA22606 ● FA22633 	<ul style="list-style-type: none"> 281,00 € 281,00 € 		
Bras individuel 500 mm. Pour support Ø 60 mm.	Single bracket 500mm. For pole Ø 60mm.	<ul style="list-style-type: none"> ● FA22706 ● FA22733 	<ul style="list-style-type: none"> 198,00 € 198,00 € 		
Bras double 500 mm. Pour support Ø 60 mm.	Double bracket 500mm. For pole Ø 60mm.	<ul style="list-style-type: none"> ● FA22806 ● FA22833 	<ul style="list-style-type: none"> 336,00 € 336,00 € 		

Perseo 3 Ø 76mm

Bras individuel 180 mm.
Pour support Ø 76 mm.

Single bracket 180mm.
For pole Ø 76mm.

● FA22906
● FA22933

115,00 €
115,00 €

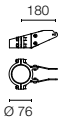

Bras double 180 mm.
Pour support Ø 76 mm.

Double bracket 180mm.
For pole Ø 76mm.

● FA23006
● FA23033

241,00 €
241,00 €

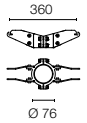

Bras individuel 500 mm.
Pour support Ø 76 mm.

Single bracket 500mm.
For pole Ø 76mm.

● FA23106
● FA23133

171,00 €
171,00 €

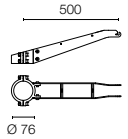

Bras double 500 mm.
Pour support Ø 76 mm.

Double bracket 500mm.
For pole Ø 76mm.

● FA23206
● FA23233

336,00 €
336,00 €

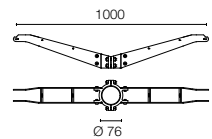

Perseo 3 Ø 102mm

Bras individuel 180 mm.
Pour support Ø 102 mm.

Single bracket 180mm.
For pole Ø 102mm.

● FA22106
● FA22133

111,00 €
111,00 €

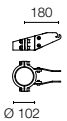

Bras double 180 mm.
Pour support Ø 102 mm.

Double bracket 180mm.
For pole Ø 102mm.

● FA22206
● FA22233

159,00 €
159,00 €

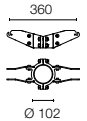

Bras individuel 500 mm.
Pour support Ø 102 mm.

Single bracket 500mm.
For pole Ø 102mm.

● FA22306
● FA22333

177,00 €
177,00 €

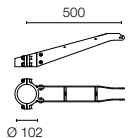

Bras double 500 mm.
Pour support Ø 102 mm.

Double bracket 500mm.
For pole Ø 102mm.

● FA22406
● FA22433

336,00 €
336,00 €

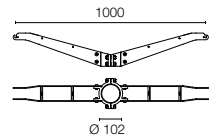

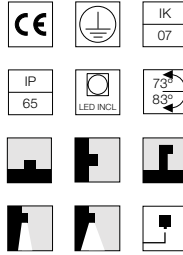
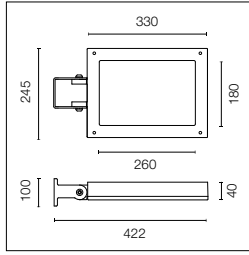

Source LED incluse. Source d'alimentation électrique intégrée 220-240V. Équerre de maintien graduée incluse. Équipé d'une gaine en métal M20x1,5 (pour des câbles de 7mmϕ<math><13\text{mm}</math>). Pour garantir l'étanchéité de la gaine il est conseillé d'utiliser des câbles électriques flexibles et conçus pour l'extérieur. Accessoires optionnels : Bras sortant pour mur ; pieds et bras pour être installé en tant que mât ; viseur wall-washer et couvercle protecteur anti-vandalisme. Verre transparent.

LED source included. Integrated power supply 220-240V. Graduated fixing bracket included. Equipped with a M20x1.5 cable guide (for 7mmϕ<math><13\text{mm}</math> cables) and IP68 connector. To ensure the tightness of the cable guide it's recommended to use flexible electric cables suitable for exterior use. Optional accessories: protruding arm for walls; feet and arms to install the luminaire on a mast; wall-washer visor and anti-vandalism protection lid. Extraclear transparent glass.

2200K disponible sur demande.

2200K available on request.

Optic Spot 11°

Power Led: 53W - 5859 lm \neq OUTPUT 3989 lm - 2700K/CRI 80 - 220-240V / 53W - 6363 lm \neq OUTPUT 4332 lm - 3000K/CRI 80 - 220-240V / 53W - 6657 lm \neq OUTPUT 4533 lm - 4000K/CRI 80 - 220-240V

2700K

3000K

4000K

Non Dimmable		Non Dimmable		Non Dimmable	
○ FA52516001	759,00 €	○ FA52513301	759,00 €	○ FA52513201	759,00 €
● FA52516006	759,00 €	● FA52513306	759,00 €	● FA52513206	759,00 €
● FA52516012	759,00 €	● FA52513312	759,00 €	● FA52513212	759,00 €
● FA52516018	759,00 €	● FA52513318	759,00 €	● FA52513218	759,00 €
● FA52516030	759,00 €	● FA52513330	759,00 €	● FA52513230	759,00 €
● FA52516033	759,00 €	● FA52513333	759,00 €	● FA52513233	759,00 €
1-10V		1-10V		1-10V	
○ FA52516001-310	773,00 €	○ FA52513301-310	773,00 €	○ FA52513201-310	773,00 €
● FA52516006-310	773,00 €	● FA52513306-310	773,00 €	● FA52513206-310	773,00 €
● FA52516012-310	773,00 €	● FA52513312-310	773,00 €	● FA52513212-310	773,00 €
● FA52516018-310	773,00 €	● FA52513318-310	773,00 €	● FA52513218-310	773,00 €
● FA52516030-310	773,00 €	● FA52513330-310	773,00 €	● FA52513230-310	773,00 €
● FA52516033-310	773,00 €	● FA52513333-310	773,00 €	● FA52513233-310	773,00 €
Dali		Dali		Dali	
○ FA52516001-300	846,00 €	○ FA52513301-300	846,00 €	○ FA52513201-300	846,00 €
● FA52516006-300	846,00 €	● FA52513306-300	846,00 €	● FA52513206-300	846,00 €
● FA52516012-300	846,00 €	● FA52513312-300	846,00 €	● FA52513212-300	846,00 €
● FA52516018-300	846,00 €	● FA52513318-300	846,00 €	● FA52513218-300	846,00 €
● FA52516030-300	846,00 €	● FA52513330-300	846,00 €	● FA52513230-300	846,00 €
● FA52516033-300	846,00 €	● FA52513333-300	846,00 €	● FA52513233-300	846,00 €

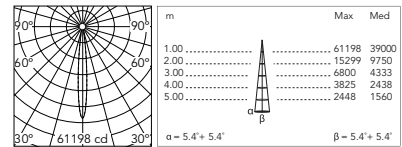

@ 4000K

Optic Medium 34°

Power Led: 53W - 5859 lm \neq OUTPUT 4056 lm - 2700K/CRI 80 - 220-240V / 53W - 6363 lm \neq OUTPUT 4405 lm - 3000K/CRI 80 - 220-240V / 53W - 6657 lm \neq OUTPUT 4609 lm - 4000K/CRI 80 - 220-240V

2700K

3000K

4000K

Non Dimmable		Non Dimmable		Non Dimmable	
○ FA52516201	759,00 €	○ FA52512301	759,00 €	○ FA52512201	759,00 €
● FA52516206	759,00 €	● FA52512306	759,00 €	● FA52512206	759,00 €
● FA52516212	759,00 €	● FA52512312	759,00 €	● FA52512212	759,00 €
● FA52516218	759,00 €	● FA52512318	759,00 €	● FA52512218	759,00 €
● FA52516230	759,00 €	● FA52512330	759,00 €	● FA52512230	759,00 €
● FA52516233	759,00 €	● FA52512333	759,00 €	● FA52512233	759,00 €
1-10V		1-10V		1-10V	
○ FA52516201-310	773,00 €	○ FA52512301-310	773,00 €	○ FA52512201-310	773,00 €
● FA52516206-310	773,00 €	● FA52512306-310	773,00 €	● FA52512206-310	773,00 €
● FA52516212-310	773,00 €	● FA52512312-310	773,00 €	● FA52512212-310	773,00 €
● FA52516218-310	773,00 €	● FA52512318-310	773,00 €	● FA52512218-310	773,00 €
● FA52516230-310	773,00 €	● FA52512330-310	773,00 €	● FA52512230-310	773,00 €
● FA52516233-310	773,00 €	● FA52512333-310	773,00 €	● FA52512233-310	773,00 €
Dali		Dali		Dali	
○ FA52516201-300	846,00 €	○ FA52512301-300	846,00 €	○ FA52512201-300	846,00 €
● FA52516206-300	846,00 €	● FA52512306-300	846,00 €	● FA52512206-300	846,00 €
● FA52516212-300	846,00 €	● FA52512312-300	846,00 €	● FA52512212-300	846,00 €
● FA52516218-300	846,00 €	● FA52512318-300	846,00 €	● FA52512218-300	846,00 €
● FA52516230-300	846,00 €	● FA52512330-300	846,00 €	● FA52512230-300	846,00 €
● FA52516233-300	846,00 €	● FA52512333-300	846,00 €	● FA52512233-300	846,00 €

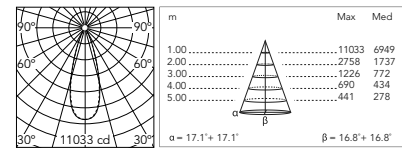

@ 4000K

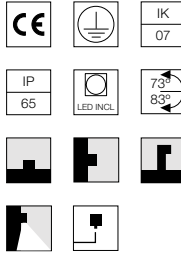
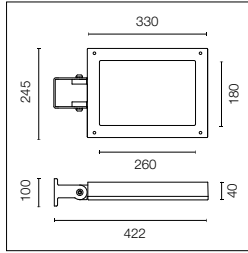

Source LED incluse. Source d'alimentation électrique intégrée 220-240V ON/OFF et intensité réglable entre 1 y 10V ou DALI. Équerre de maintien graduée incluse. Équipé d'une gaine en métal M20x1,5 (pour des câbles de 7mm\varnothing<math><13\text{mm}</math>). Pour garantir l'étanchéité de la gaine il est conseillé d'utiliser des câbles électriques flexibles et conçus pour l'extérieur. Accessoires optionnels : Bras sortant pour mur ; pieds et bras pour être installé en tant que mât ; viseur wall-washer et couverture protecteur anti-vandalisme. Verre transparent.

LED source included. Integrated power supply 220-240V ON-OFF and dimmable 1-10V or DALI. Graduated fixing bracket included. Equipped with a M20x1.5 cable guide (for 7mm- \varnothing <math><13\text{mm}</math> cables) and IP68 connector. To ensure the tightness of the cable guide it's recommended to use flexible electric cables suitable for exterior use. Optional accessories: protruding arm for walls; feet and arms to install the luminaire on a mast; wall-washer visor and anti-vandalism protection lid. Extraclear transparent glass.

2200K disponible sur demande.

2200K available on request.

Asymmetric Optic

Power Led: 53W - 5859 lm \neq OUTPUT 3085 lm - 2700K/CRI 80 - 220-240V / 53W - 6363 lm \neq OUTPUT 3350 lm - 3000K/CRI 80 - 220-240V / 53W - 6657 lm \neq OUTPUT 3505 lm - 4000K/CRI 80 - 220-240V

2700K

Non Dimmable	
○ FA52516401	759,00 €
● FA52516406	759,00 €
● FA52516412	759,00 €
● FA52516418	759,00 €
● FA52516430	759,00 €
● FA52516433	759,00 €
1-10V	
○ FA52516401-310	773,00 €
● FA52516406-310	773,00 €
● FA52516412-310	773,00 €
● FA52516418-310	773,00 €
● FA52516430-310	773,00 €
● FA52516433-310	773,00 €
Dali	
○ FA52516401-300	846,00 €
● FA52516406-300	846,00 €
● FA52516412-300	846,00 €
● FA52516418-300	846,00 €
● FA52516430-300	846,00 €
● FA52516433-300	846,00 €

3000K

Non Dimmable	
○ FA52510301	759,00 €
● FA52510306	759,00 €
● FA52510312	759,00 €
● FA52510318	759,00 €
● FA52510330	759,00 €
● FA52510333	759,00 €
1-10V	
○ FA52510301-310	773,00 €
● FA52510306-310	773,00 €
● FA52510312-310	773,00 €
● FA52510318-310	773,00 €
● FA52510330-310	773,00 €
● FA52510333-310	773,00 €
Dali	
○ FA52510301-300	846,00 €
● FA52510306-300	846,00 €
● FA52510312-300	846,00 €
● FA52510318-300	846,00 €
● FA52510330-300	846,00 €
● FA52510333-300	846,00 €

4000K

Non Dimmable	
○ FA52510201	759,00 €
● FA52510206	759,00 €
● FA52510212	759,00 €
● FA52510218	759,00 €
● FA52510230	759,00 €
● FA52510233	759,00 €
1-10V	
○ FA52510201-310	773,00 €
● FA52510206-310	773,00 €
● FA52510212-310	773,00 €
● FA52510218-310	773,00 €
● FA52510230-310	773,00 €
● FA52510233-310	773,00 €
Dali	
○ FA52510201-300	846,00 €
● FA52510206-300	846,00 €
● FA52510212-300	846,00 €
● FA52510218-300	846,00 €
● FA52510230-300	846,00 €
● FA52510233-300	846,00 €

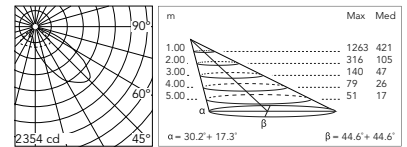

@ 4000K

Street Light 120°

Power Led: 53W - 5859 lm \neq OUTPUT 2609 lm - 2700K/CRI 80 - 220-240V / 53W - 6363 lm \neq OUTPUT 2834 lm - 3000K/CRI 80 - 220-240V / 53W - 6657 lm \neq OUTPUT 2965 lm - 4000K/CRI 80 - 220-240V

2700K

Non Dimmable	
○ FA52516601	759,00 €
● FA52516606	759,00 €
● FA52516612	759,00 €
● FA52516618	759,00 €
● FA52516630	759,00 €
● FA52516633	759,00 €
1-10V	
○ FA52516601-310	773,00 €
● FA52516606-310	773,00 €
● FA52516612-310	773,00 €
● FA52516618-310	773,00 €
● FA52516630-310	773,00 €
● FA52516633-310	773,00 €
Dali	
○ FA52516601-300	846,00 €
● FA52516606-300	846,00 €
● FA52516612-300	846,00 €
● FA52516618-300	846,00 €
● FA52516630-300	846,00 €
● FA52516633-300	846,00 €

3000K

Non Dimmable	
○ FA52511301	759,00 €
● FA52511306	759,00 €
● FA52511312	759,00 €
● FA52511318	759,00 €
● FA52511330	759,00 €
● FA52511333	759,00 €
1-10V	
○ FA52511301-310	773,00 €
● FA52511306-310	773,00 €
● FA52511312-310	773,00 €
● FA52511318-310	773,00 €
● FA52511330-310	773,00 €
● FA52511333-310	773,00 €
Dali	
○ FA52511301-300	846,00 €
● FA52511306-300	846,00 €
● FA52511312-300	846,00 €
● FA52511318-300	846,00 €
● FA52511330-300	846,00 €
● FA52511333-300	846,00 €

4000K

Non Dimmable	
○ FA52511201	759,00 €
● FA52511206	759,00 €
● FA52511212	759,00 €
● FA52511218	759,00 €
● FA52511230	759,00 €
● FA52511233	759,00 €
1-10V	
○ FA52511201-310	773,00 €
● FA52511206-310	773,00 €
● FA52511212-310	773,00 €
● FA52511218-310	773,00 €
● FA52511230-310	773,00 €
● FA52511233-310	773,00 €
Dali	
○ FA52511201-300	846,00 €
● FA52511206-300	846,00 €
● FA52511212-300	846,00 €
● FA52511218-300	846,00 €
● FA52511230-300	846,00 €
● FA52511233-300	846,00 €

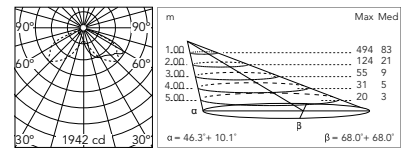

@ 4000K

Perseo 4 RGB

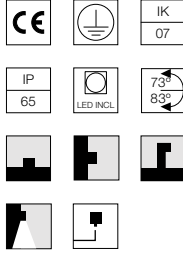
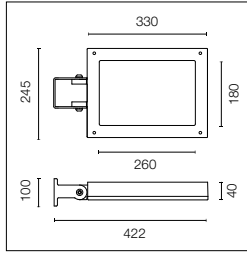

Source LED incluse. Source d'alimentation électrique intégrée 220-240V. Équerre de maintien graduée incluse. Équipé d'une gaine en métal M20x1,5 (pour des câbles de 7mm\varnothing<math><13\text{mm}</math>). Pour garantir l'étanchéité de la gaine il est conseillé d'utiliser des câbles électriques flexibles et conçus pour l'extérieur. Accessoires optionnels : Bras sortant pour mur ; pieds et bras pour être installé en tant que mât ; viseur wall-washer et couverture protecteur anti-vandalisme. Verre transparent.

LED source included. Integrated power supply 220-240V. Graduated fixing bracket included. Equipped with a M20x1.5 cable guide (for 7mm\varnothing<math><13\text{mm}</math> cables) and IP68 connector. To ensure the tightness of the cable guide it's recommended to use flexible electric cables suitable for exterior use. Optional accessories: protruding arm for walls; feet and arms to install the luminaire on a mast; wall-washer visor and anti-vandalism protection lid. Extraclear transparent glass.

Schéma électrique et installation système RGB.

Voir schéma électrique n.8 Page 833.

Wiring diagram and installation scheme RGB.

See Wiring Diagram n.8 Page 833.

Optic Medium 40°

RGB Power Led: 35W - 220-240V with DMX interface.

RGB

○ FA52512401	1.359,00 €
● FA52512406	1.359,00 €
● FA52512412	1.359,00 €
● FA52512418	1.359,00 €
● FA52512430	1.359,00 €
● FA52512433	1.359,00 €

Perseo 4 LED / Ø 76mm - Poles

Avec base et boîte de dérivation.

With Base and Access Door.
With Terminal Block 4x1,5-16mmq.



H 3500mm

- FA24806 702,00 €
- FA24833 702,00 €

H 4500mm

- FA24906 852,00 €
- FA24933 852,00 €

Encastrable (+500 mm en dessous du sol)
Avec boîte de dérivation

In-Ground (+500 mm Root) With Access Door
With Terminal Block 4x1,5-16mmq

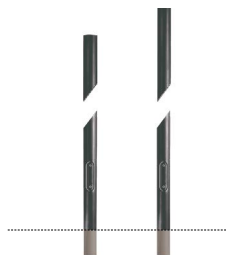

H 3500mm

- FA25006 644,00 €
- FA25033 644,00 €

H 4500mm

- FA25106 759,00 €
- FA25133 759,00 €

Perseo 4 LED / Ø 102mm - Poles

Avec base et boîte de dérivation.

With Base and Access Door .
With Terminal Block 4x1,5-16mmq.



H 4000mm

- FA414006 852,00 €
- FA414033 852,00 €

H 5000mm

- FA415006 978,00 €
- FA415033 978,00 €

Encastrable (+500 mm en dessous du sol)
Avec boîte de dérivation

In-Ground (+500 mm Root) With Access Door
With Terminal Block 4x1,5-16mmq

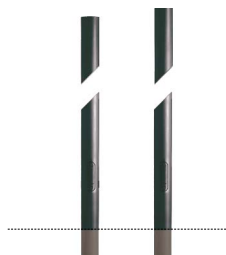

H 4000mm







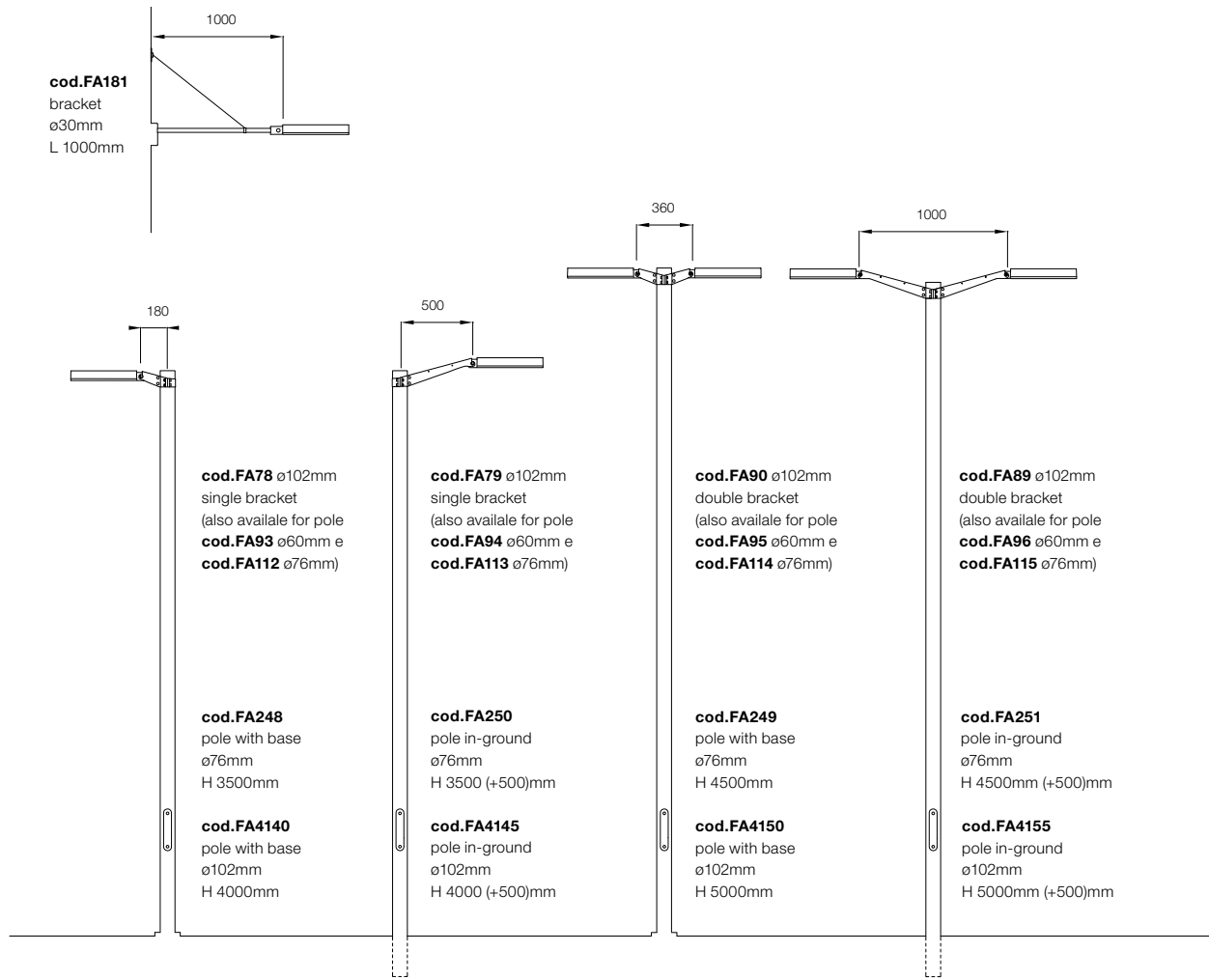



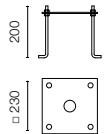

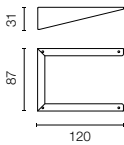

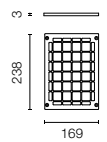
- FA414506 773,00 €
- FA414533 773,00 €

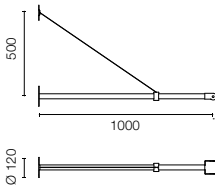
H 5000mm

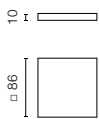
- FA415506 932,00 €
- FA415533 932,00 €

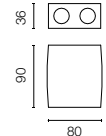

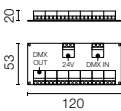
Perseo 4: Accessoires / Accessories

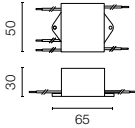
Plaque de boulons.	Base plate with bolt.	FA116	97,00 €		
Viseur Wall-Washerr	Wall Washer Visor	FA16730	86,00 €		
Couvercle extérieur anti-vandalisme	Anti vandal louvre	FA16830	93,00 €		
Bras 1000 mm.	Wall bracket 1000mm.	<ul style="list-style-type: none"> ○ FA18101 ● FA18106 ● FA18112 ● FA18118 ● FA18130 ● FA18133 	<ul style="list-style-type: none"> 254,00 € 254,00 € 254,00 € 254,00 € 254,00 € 254,00 € 		
Contrôleur DMX pour boîtes encastrables. (60 mm d'entraxe)	DMX controller; dimmer switch for recessed box (60mm hole centres).	RGB version F990B10A000	1.006,00 €		
Contrôleur DMX. Interface stand-alone PC.	DMX controller; stand-alone/PC interface.	RGB version F990B11A000	1.306,00 €		
DMX splitter 512- dispositif électronique pour régénérer le signal DMX monodirectionnel. 1 entrée et 7 sorties, 12-24 Vdc. Source d'alimentation non incluse.	DMX splitter 512 - electronic device to regenerate the monodirectional DMX signal 1 Input and 7 output, 12-24Vdc. Power supply not included.	RGB version F990B13A000	227,00 €		
Câble DMX blindé à impédance constante 110 Ohm.	DMX cable - shielded twisted pair with 110 Ohm constant impedance.	RGB version F990B12A000	19,00 €		
Dispositif de protection contre les surtensions. 275Vac. Courant de décharge maximal 10KA (8/20µs). Maximum operating current 5A. Suitable for series connection. IP66. Adapté pour les connexions en séries. IP66.	Surge protection device. 275Vac. Maximum discharge current 10KA (8/20µs). Maximum operating current 5A. Suitable for series connection. IP66.	F990E00A000	116,00 €		

Perseo 4 Ø 60mm

Bras individuel 180 mm.
Pour support Ø 60 mm.

Single bracket 180mm.
For pole Ø 60mm.

- FA9306
- FA9333

123,00 €
123,00 €

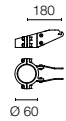

Bras double 180 mm.
Pour support Ø 60 mm.

Double bracket 180mm.
For pole Ø 60mm.

- FA9506
- FA9533

188,00 €
188,00 €

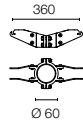

Bras individuel 500 mm.
Pour support Ø 60 mm.

Single bracket 500mm.
For pole Ø 60mm.

- FA9406
- FA9433

193,00 €
193,00 €

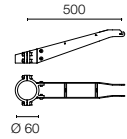

Bras double 500 mm.
Pour support Ø 60 mm.

Double bracket 500mm.
For pole Ø 60mm.

- FA9606
- FA9633

336,00 €
336,00 €

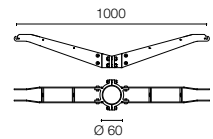

Perseo 4 Ø 76mm

Bras individuel 180 mm.
Pour support Ø 76 mm.

Single bracket 180mm.
For pole Ø 76mm.

- FA11206
- FA11233

90,00 €
90,00 €

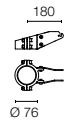

Bras double 180 mm.
Pour support Ø 76 mm.

Double bracket 180mm.
For pole Ø 76mm.

- FA11406
- FA11433

153,00 €
153,00 €

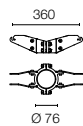

Bras individuel 500 mm.
Pour support Ø 76 mm.

Single bracket 500mm.
For pole Ø 76mm.

- FA11306
- FA11333

169,00 €
169,00 €

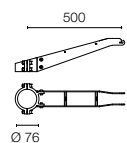

Bras double 500 mm.
Pour support Ø 76 mm.

Double bracket 500mm.
For pole Ø 76mm.

- FA11506
- FA11533

330,00 €
330,00 €

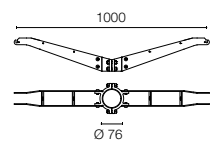

Perseo 4 Ø 102mm

Bras individuel 180 mm.
Pour support Ø 102 mm.

Single bracket 180mm.
For pole Ø 102mm.

- FA7806
- FA7833

86,00 €
86,00 €

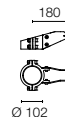

Bras double 180 mm.
Pour support Ø 102 mm.

Double bracket 180mm.
For pole Ø 102mm.

- FA9006
- FA9033

158,00 €
158,00 €

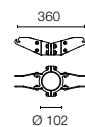

Bras individuel 500 mm.
Pour support Ø 102 mm.

Single bracket 500mm.
For pole Ø 102mm.

- FA7906
- FA7933

174,00 €
174,00 €

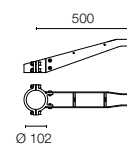

Bras double 500 mm.
Pour support Ø 102 mm.

Double bracket 500mm.
For pole Ø 102mm.

- FA8906
- FA8933

336,00 €
336,00 €

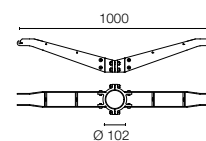

Dooku







Famille / Family

Dooku 400 Wall



Power Led

up to 39W
up to 2946 lm - 2700K/CRI 80
up to 3168 lm - 3000K/CRI 80
up to 3374 lm - 4000K/CRI 80

* Net lumen output

2200K available on request.

Dooku 400 Pole/Double Pole Ø76

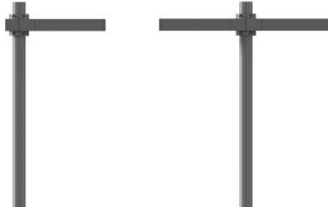

Power Led

up to 39W
up to 3389 lm - 2700K/CRI 80
up to 3631 lm - 3000K/CRI 80
up to 3752 lm - 4000K/CRI 80

* Net lumen output

2200K available on request.

Power Led

up to 2x39W
up to 2x3389 lm - 2700K/CRI 80
up to 2x3631 lm - 3000K/CRI 80
up to 2x3752 lm - 4000K/CRI 80

* Net lumen output

2200K available on request.

Dooku 400 Pole/Double Pole Ø102

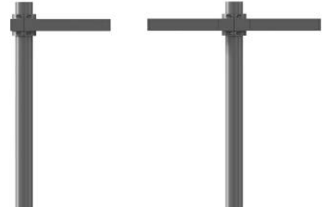

Power Led

up to 39W
up to 3389 lm - 2700K/CRI 80
up to 3631 lm - 3000K/CRI 80
up to 3752 lm - 4000K/CRI 80

* Net lumen output

2200K available on request.

Power Led

up to 2x39W
up to 2x3389 lm - 2700K/CRI 80
up to 2x3631 lm - 3000K/CRI 80
up to 2x3752 lm - 4000K/CRI 80

* Net lumen output

2200K available on request.

Dooku 600 Pole/Double Pole Ø76

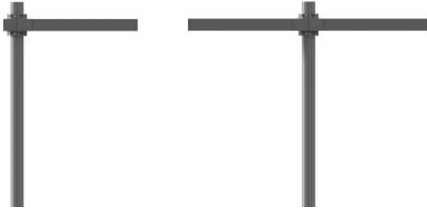

Power Led

up to 78W
up to 6779 lm - 2700K/CRI 80
up to 7263 lm - 3000K/CRI 80
up to 7505 lm - 4000K/CRI 80

* Net lumen output

2200K available on request.

Power Led

up to 2x78W
up to 2x6779 lm - 2700K/CRI 80
up to 2x7263 lm - 3000K/CRI 80
up to 2x7505 lm - 4000K/CRI 80

* Net lumen output

2200K available on request.

Dooku 600 Pole/Double Pole Ø102

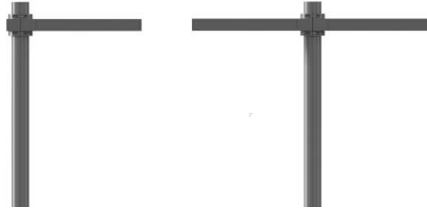

Power Led

up to 78W
up to 6779 lm - 2700K/CRI 80
up to 7263 lm - 3000K/CRI 80
up to 7505 lm - 4000K/CRI 80

* Net lumen output

2200K available on request.

Power Led

up to 2x78W
up to 2x6779 lm - 2700K/CRI 80
up to 2x7263 lm - 3000K/CRI 80
up to 2x7505 lm - 4000K/CRI 80

* Net lumen output

2200K available on request.

Finitions / Colours



06 Grey



33 Anthracite

Description / Description

Famille complète de luminaires de projection avec source LED, conçus pour être installés au mur et sur un poteau en tant que mât. Disponibles en deux longueurs et avec différentes optiques pour chaque taille. Ils incluent des optiques spécifiques pour le milieu urbain. Structure en aluminium extrudé et parties de la fermeture en aluminium moulé sous pression EN AB-47100 (à faible teneur en cuivre). Diffuseur en verre extra-clair avec un bord sérigraphié, fixé par un système d'encollage robotisé. Disponibles en différentes finitions avec un revêtement à poudre double couche et une surface traitée par procédé de conversion chimique pour garantir une haute résistance à la corrosion. Équipés d'un câble en néoprène et d'un connecteur IP68 qui garantissent un câblage facile, sécurisé et étanche.

Dooku 400 Wall

Luminaires de projection ajustable, conçus pour être installés au mur. Disponibles avec deux ouvertures du faisceau lumineux : symétrique et asymétrique, pour les espaces publics et privés, les espaces urbains, les espaces ouverts et les parkings. Équipés d'un câble en néoprène et des connecteurs IP68 qui garantissent un câblage facile, sécurisé et étanche. L'équerre de maintien zinguée permet une orientation d'environ 90° sur l'axe vertical.

Dooku 400 / 600 Top Pole

Luminaires de type mât conçus pour être installés sur des poteaux. Disponibles en deux longueurs, avec plusieurs puissances et quatre ouvertures du faisceau lumineux : symétrique, asymétrique, faisceau urbain standard et faisceau urbain spécifique pour les parcours cyclo-piétons dans le milieu urbain. Équipés d'un câble en néoprène et des connecteurs IP68 qui garantissent un câblage facile, sécurisé et étanche. La gamme est complétée par une série de poteaux cylindriques, avec des diamètres et hauteurs différents, qui peuvent être encastrés ou fixés à l'aide d'une plaque d'ancrage et des tire-fonds.

Complete family of tiltable projection luminaires with LED source for wall mounting and installation on masts. Available in two lengths and with different optics for every dimension, including optics for urban uses. Extruded EN AB-47100 die cast aluminum body and closing parts (with low copper content). Extraclear glass diffuser with silkscreen edge, attached with a robotic gluing system. Available in different finishes, with double-layered powder coating and chemical conversion surface treatment to ensure high corrosion resistance. Equipped with a neoprene cable section and IP68 connector to guarantee an easy, safe, and watertight connection.

Dooku 400 Wall

Tiltable projection luminaires for wall mounting. Available with two beam angles: symmetrical and asymmetrical for public, private, and urban areas, open spaces, or parking lots. Equipped with a neoprene cable section and IP68 connector to guarantee an easy, safe, and watertight connection. The zinc fixing bracket allows for a tilting of approx. 90° on the vertical axis.

Dooku 400 / 600 Top Pole

Mast luminaires for mounting on poles. Available in two lengths, with different output and four beam angles: symmetrical, asymmetrical, urban standard beam and a specific urban beam for pedestrian and bicycle lanes in urban contexts. Equipped with a neoprene cable section and IP68 connectors to guarantee an easy, safe, and watertight connection. Completed with a series of cylinder posts in different diameters and heights that can be ground recessed or fixed with an anchor plate and lag screws.

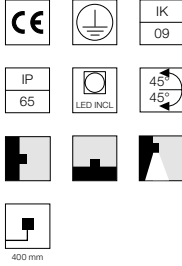
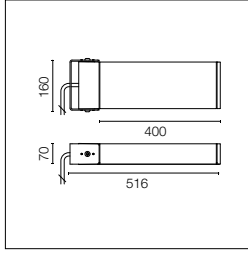

Source LED incluse. Source d'alimentation électrique intégrée 220-240V ON/OFF et intensité réglable entre 1 y 10V ou DALI. Équerre de maintien incluse. Équipé d'un câble sortant de 400 mm en néoprène et des connecteurs IP68. Version Smart-City disponible sur demande.

LED source included. Integrated power supply 220-240V ON/OFF and dimmable 1-10V or DALI. Fixing bracket included. Equipped with a 400mm protruding neoprene cable section and IP68 connectors. Smart-City version available upon request.

2200K disponible sur demande.

2200K available on request.

Optic 120° (Wide Spaces - Public Areas - Parking Areas)

Power Led: 39W - 4122 lm ≠ OUTPUT 3389 lm - 2700K/CRI 80 - 220÷240V / 39W - 4416 lm ≠ OUTPUT 3631 lm - 3000K/CRI 80 - 220÷240V / 39W - 4563 lm ≠ OUTPUT 3752 lm - 4000K/CRI 80 - 220÷240V

2700K

- Non Dimmable
- FA53907606 904,00 €
- FA53907633 904,00 €
- 1-10V
- FA53907606-310 1.025,00 €
- FA53907633-310 1.025,00 €
- Dali
- FA53907606-300 1.025,00 €
- FA53907633-300 1.025,00 €

3000K

- Non Dimmable
- FA53907506 904,00 €
- FA53907533 904,00 €
- 1-10V
- FA53907506-310 1.025,00 €
- FA53907533-310 1.025,00 €
- Dali
- FA53907506-300 1.025,00 €
- FA53907533-300 1.025,00 €

4000K

- Non Dimmable
- FA53907406 904,00 €
- FA53907433 904,00 €
- 1-10V
- FA53907406-310 1.025,00 €
- FA53907433-310 1.025,00 €
- Dali
- FA53907406-300 1.025,00 €
- FA53907433-300 1.025,00 €

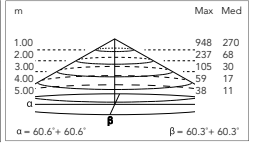
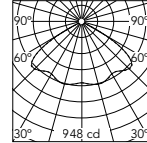

@ 3000K

Asymmetric Optic

Power Led: 39W - 4122 lm ≠ OUTPUT 3173 lm - 2700K/CRI 80 - 220÷240V / 39W - 4416 lm ≠ OUTPUT 3400 lm - 3000K/CRI 80 - 220÷240V / 39W - 4563 lm ≠ OUTPUT 3513 lm - 4000K/CRI 80 - 220÷240V

2700K

- Non Dimmable
- FA53913006 880,00 €
- FA53913033 880,00 €
- 1-10V
- FA53913006-310 1.001,00 €
- FA53913033-310 1.001,00 €
- Dali
- FA53913006-300 1.001,00 €
- FA53913033-300 1.001,00 €

3000K

- Non Dimmable
- FA53914806 880,00 €
- FA53914833 880,00 €
- 1-10V
- FA53914806-310 1.001,00 €
- FA53914833-310 1.001,00 €
- Dali
- FA53914806-300 1.001,00 €
- FA53914833-300 1.001,00 €

4000K

- Non Dimmable
- FA53916606 880,00 €
- FA53916633 880,00 €
- 1-10V
- FA53916606-310 1.001,00 €
- FA53916633-310 1.001,00 €
- Dali
- FA53916606-300 1.001,00 €
- FA53916633-300 1.001,00 €

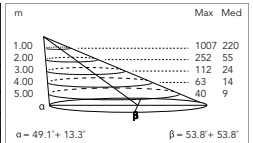
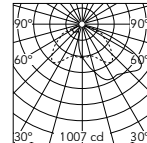

@ 3000K

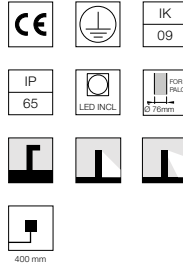
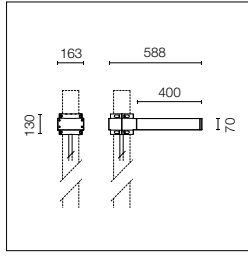

Source LED incluse. Source d'alimentation électrique intégrée 220-240V ON/OFF et intensité réglable entre 1 y 10V ou DALI. Équerre de maintien incluse. Équipé d'un câble sortant de 400 mm en néoprène et des connecteurs IP68. Prise individuelle pour poteaux de 76 mm de diamètre. Le poteau est à commander séparément. Version Smart-City disponible sur demande.

LED source included. Integrated power supply 220-240V ON/OFF and dimmable 1-10V or DALI. Fixing bracket included. Equipped with a 400mm protruding neoprene cable section and IP68 connectors. Single socket for 76mm diameter post. The post must be ordered separately. Smart-City version available upon request.

2200K disponible sur demande.

2200K available on request.

Optic 120° (Wide Spaces - Public Areas - Parking Areas)

Power Led: 39W - 4122 lm ≠ OUTPUT 3389 lm - 2700K/CRI 80 - 220÷240V / 39W - 4416 lm ≠ OUTPUT 3631 lm - 3000K/CRI 80 - 220÷240V / 39W - 4563 lm ≠ OUTPUT 3752 lm - 4000K/CRI 80 - 220÷240V

2700K

Non Dimmable	
● FA53907806	904,00 €
● FA53907833	904,00 €
1-10V	
● FA53907806-310	1.025,00 €
● FA53907833-310	1.025,00 €
Dali	
● FA53907806-300	1.025,00 €
● FA53907833-300	1.025,00 €

3000K

Non Dimmable	
● FA53903906	904,00 €
● FA53903933	904,00 €
1-10V	
● FA53903906-310	1.025,00 €
● FA53903933-310	1.025,00 €
Dali	
● FA53903906-300	1.025,00 €
● FA53903933-300	1.025,00 €

4000K

Non Dimmable	
● FA53903806	904,00 €
● FA53903833	904,00 €
1-10V	
● FA53903806-310	1.025,00 €
● FA53903833-310	1.025,00 €
Dali	
● FA53903806-300	1.025,00 €
● FA53903833-300	1.025,00 €

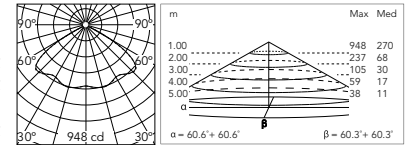

@ 3000K

Asymmetric Optic

Power Led: 39W - 4122 lm ≠ OUTPUT 3173 lm - 2700K/CRI 80 - 220÷240V / 39W - 4416 lm ≠ OUTPUT 3400 lm - 3000K/CRI 80 - 220÷240V / 39W - 4563 lm ≠ OUTPUT 3513 lm - 4000K/CRI 80 - 220÷240V

2700K

Non Dimmable	
● FA53913206	880,00 €
● FA53913233	880,00 €
1-10V	
● FA53913206-310	1.001,00 €
● FA53913233-310	1.001,00 €
Dali	
● FA53913206-300	1.001,00 €
● FA53913233-300	1.001,00 €

3000K

Non Dimmable	
● FA53915006	880,00 €
● FA53915033	880,00 €
1-10V	
● FA53915006-310	1.001,00 €
● FA53915033-310	1.001,00 €
Dali	
● FA53915006-300	1.001,00 €
● FA53915033-300	1.001,00 €

4000K

Non Dimmable	
● FA53916806	880,00 €
● FA53916833	880,00 €
1-10V	
● FA53916806-310	1.001,00 €
● FA53916833-310	1.001,00 €
Dali	
● FA53916806-300	1.001,00 €
● FA53916833-300	1.001,00 €

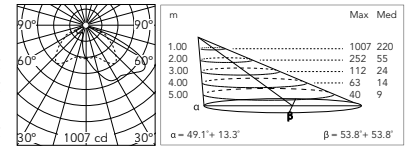

@ 3000K

Street Light Optic

Power Led: 39W - 4122 lm ≠ OUTPUT 3102 lm - 2700K/CRI 80 - 220÷240V / 39W - 4416 lm ≠ OUTPUT 3323 lm - 3000K/CRI 80 - 220÷240V / 39W - 4563 lm ≠ OUTPUT 3434 lm - 4000K/CRI 80 - 220÷240V

2700K

Non Dimmable	
● FA53908006	904,00 €
● FA53908033	904,00 €
1-10V	
● FA53908006-310	1.025,00 €
● FA53908033-310	1.025,00 €
Dali	
● FA53908006-300	1.025,00 €
● FA53908033-300	1.025,00 €

3000K

Non Dimmable	
● FA53904206	904,00 €
● FA53904233	904,00 €
1-10V	
● FA53904206-310	1.025,00 €
● FA53904233-310	1.025,00 €
Dali	
● FA53904206-300	1.025,00 €
● FA53904233-300	1.025,00 €

4000K

Non Dimmable	
● FA53904106	904,00 €
● FA53904133	904,00 €
1-10V	
● FA53904106-310	1.025,00 €
● FA53904133-310	1.025,00 €
Dali	
● FA53904106-300	1.025,00 €
● FA53904133-300	1.025,00 €

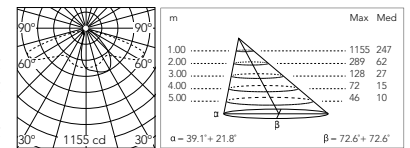

@ 3000K

Street Light Optic (Foot and Cycle Paths)

Power Led: 39W - 4122 lm ≠ OUTPUT 3130 lm - 2700K/CRI 80 - 220÷240V / 39W - 4416 lm ≠ OUTPUT 3354 lm - 3000K/CRI 80 - 220÷240V / 39W - 4563 lm ≠ OUTPUT 3466 lm - 4000K/CRI 80 - 220÷240V

2700K

Non Dimmable	
● FA53908206	904,00 €
● FA53908233	904,00 €
1-10V	
● FA53908206-310	1.025,00 €
● FA53908233-310	1.025,00 €
Dali	
● FA53908206-300	1.025,00 €
● FA53908233-300	1.025,00 €

3000K

Non Dimmable	
● FA53904506	904,00 €
● FA53904533	904,00 €
1-10V	
● FA53904506-310	1.025,00 €
● FA53904533-310	1.025,00 €
Dali	
● FA53904506-300	1.025,00 €
● FA53904533-300	1.025,00 €

4000K

Non Dimmable	
● FA53904406	904,00 €
● FA53904433	904,00 €
1-10V	
● FA53904406-310	1.025,00 €
● FA53904433-310	1.025,00 €
Dali	
● FA53904406-300	1.025,00 €
● FA53904433-300	1.025,00 €

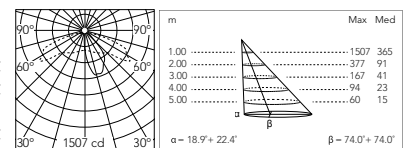

@ 3000K

Dooku 400 - Double Top Pole ø76

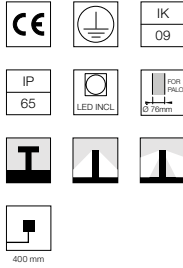
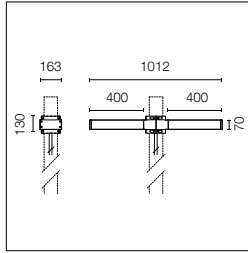

Source LED incluse. Source d'alimentation électrique intégrée 220-240V ON/OFF et intensité réglable entre 1 y 10V ou DALI. Équerre de maintien incluse. Équipé d'un câble sortant de 400 mm en néoprène et des connecteurs IP68. Prise individuelle pour poteaux de 76 mm de diamètre. Le poteau est à commander séparément. Version Smart-City disponible sur demande.

LED source included. Integrated power supply 220-240V ON/OFF and dimmable 1-10V or DALI. Fixing bracket included. Equipped with a 400mm protruding neoprene cable section and IP68 connectors. Double socket for 76mm diameter post. The post must be ordered separately. Smart-City version available upon request.

Optic 120° (Wide Spaces - Public Areas - Parking Areas)

2200K disponible sur demande. 2200K available on request.

Power Led: 39W - 2x4122 lm ≠ OUTPUT 2x3389 lm - 2700K/CRI 80 - 220÷240V / 39W - 2x4416 lm ≠ OUTPUT 2x3631 lm - 3000K/CRI 80 - 220÷240V / 39W - 2x4563 lm ≠ OUTPUT 2x3752 lm - 4000K/CRI 80 - 220÷240V

2700K

3000K

4000K

Non Dimmable		Non Dimmable		Non Dimmable	
● FA53908406	1.802,00 €	● FA53904806	1.802,00 €	● FA53904706	1.802,00 €
● FA53908433	1.802,00 €	● FA53904833	1.802,00 €	● FA53904733	1.802,00 €
1-10V					
● FA53908406-310	2.045,00 €	● FA53904806-310	2.045,00 €	● FA53904706-310	2.045,00 €
● FA53908433-310	2.045,00 €	● FA53904833-310	2.045,00 €	● FA53904733-310	2.045,00 €
Dali					
● FA53908406-300	2.045,00 €	● FA53904806-300	2.045,00 €	● FA53904706-300	2.045,00 €
● FA53908433-300	2.045,00 €	● FA53904833-300	2.045,00 €	● FA53904733-300	2.045,00 €

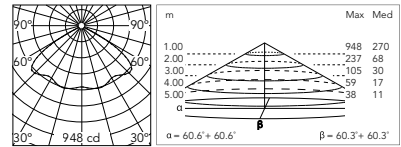

Asymmetric Optic

Power Led: 39W - 2x4122 lm ≠ OUTPUT 2x3173 lm - 2700K/CRI 80 - 220÷240V / 39W - 2x4416 lm ≠ OUTPUT 2x3400 lm - 3000K/CRI 80 - 220÷240V / 39W - 2x4563 lm ≠ OUTPUT 2x3513 lm - 4000K/CRI 80 - 220÷240V

2700K

3000K

4000K

Non Dimmable		Non Dimmable		Non Dimmable	
● FA53913406	1.758,00 €	● FA53915206	1.758,00 €	● FA53917006	1.758,00 €
● FA53913433	1.758,00 €	● FA53915233	1.758,00 €	● FA53917033	1.758,00 €
1-10V					
● FA53913406-310	1.998,00 €	● FA53915206-310	1.998,00 €	● FA53917006-310	1.998,00 €
● FA53913433-310	1.998,00 €	● FA53915233-310	1.998,00 €	● FA53917033-310	1.998,00 €
Dali					
● FA53913406-300	1.998,00 €	● FA53915206-300	1.998,00 €	● FA53917006-300	1.998,00 €
● FA53913433-300	1.998,00 €	● FA53915233-300	1.998,00 €	● FA53917033-300	1.998,00 €

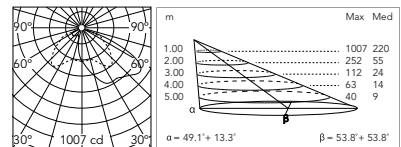

Street Light Optic

Power Led: 39W - 2x4122 lm ≠ OUTPUT 2x3102 lm - 2700K/CRI 80 - 220÷240V / 39W - 2x4416 lm ≠ OUTPUT 2x3323 lm - 3000K/CRI 80 - 220÷240V / 39W - 2x4563 lm ≠ OUTPUT 2x3434 lm - 4000K/CRI 80 - 220÷240V

2700K

3000K

4000K

Non Dimmable		Non Dimmable		Non Dimmable	
● FA53908606	1.802,00 €	● FA53905106	1.802,00 €	● FA53905006	1.802,00 €
● FA53908633	1.802,00 €	● FA53905133	1.802,00 €	● FA53905033	1.802,00 €
1-10V					
● FA53908606-310	2.045,00 €	● FA53905106-310	2.045,00 €	● FA53905006-310	2.045,00 €
● FA53908633-310	2.045,00 €	● FA53905133-310	2.045,00 €	● FA53905033-310	2.045,00 €
Dali					
● FA53908606-300	2.045,00 €	● FA53905106-300	2.045,00 €	● FA53905006-300	2.045,00 €
● FA53908633-300	2.045,00 €	● FA53905133-300	2.045,00 €	● FA53905033-300	2.045,00 €

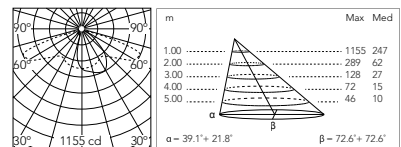

Street Light Optic (Foot and Cycle Paths)

Power Led: 39W - 2x4122 lm ≠ OUTPUT 2x3130 lm - 2700K/CRI 80 - 220÷240V / 39W - 2x4416 lm ≠ OUTPUT 2x3354 lm - 3000K/CRI 80 - 220÷240V / 39W - 2x4563 lm ≠ OUTPUT 2x3466 lm - 4000K/CRI 80 - 220÷240V

2700K

3000K

4000K

Non Dimmable		Non Dimmable		Non Dimmable	
● FA53908806	1.802,00 €	● FA53905406	1.802,00 €	● FA53905306	1.802,00 €
● FA53908833	1.802,00 €	● FA53905433	1.802,00 €	● FA53905333	1.802,00 €
1-10V					
● FA53908806-310	2.045,00 €	● FA53905406-310	2.045,00 €	● FA53905306-310	2.045,00 €
● FA53908833-310	2.045,00 €	● FA53905433-310	2.045,00 €	● FA53905333-310	2.045,00 €
Dali					
● FA53908806-300	2.045,00 €	● FA53905406-300	2.045,00 €	● FA53905306-300	2.045,00 €
● FA53908833-300	2.045,00 €	● FA53905433-300	2.045,00 €	● FA53905333-300	2.045,00 €

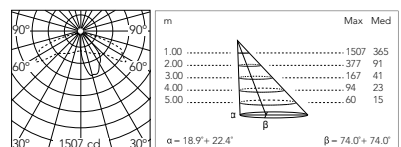

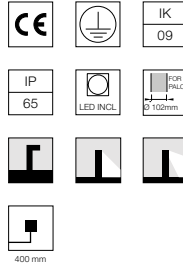
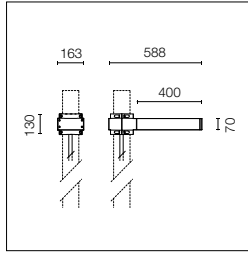

Source LED incluse. Source d'alimentation électrique intégrée 220-240V ON/OFF et intensité réglable entre 1 y 10V ou DALI. Équerre de maintien incluse. Équipé d'un câble sortant de 400 mm en néoprène et des connecteurs IP68. Prise individuelle pour poteaux de 102mm de diamètre. Le poteau est à commander séparément. Version Smart-City disponible sur demande.

LED source included. Integrated power supply 220-240V ON/OFF and dimmable 1-10V or DALI. Fixing bracket included. Equipped with a 400mm protruding neoprene cable section and IP68 connectors. Smart-City version available upon request. Single socket for 102mm diameter post. The post must be ordered separately. Smart-City version available upon request.

Optic 120° (Wide Spaces - Public Areas - Parking Areas)

2200K disponible sur demande.

2200K available on request.

Power Led: 39W - 4122 lm ≠ OUTPUT 3389 lm - 2700K/CRI 80 - 220÷240V / 39W - 4416 lm ≠ OUTPUT 3631 lm - 3000K/CRI 80 - 220÷240V / 39W - 4563 lm ≠ OUTPUT 3752 lm - 4000K/CRI 80 - 220÷240V

2700K

3000K

4000K

Non Dimmable		Non Dimmable		Non Dimmable	
● FA53909006	904,00 €	● FA53905706	904,00 €	● FA53905606	904,00 €
● FA53909033	904,00 €	● FA53905733	904,00 €	● FA53905633	904,00 €
1-10V		1-10V		1-10V	
● FA53909006-310	1.025,00 €	● FA53905706-310	1.025,00 €	● FA53905606-310	1.025,00 €
● FA53909033-310	1.025,00 €	● FA53905733-310	1.025,00 €	● FA53905633-310	1.025,00 €
Dali		Dali		Dali	
● FA53909006-300	1.025,00 €	● FA53905706-300	1.025,00 €	● FA53905606-300	1.025,00 €
● FA53909033-300	1.025,00 €	● FA53905733-300	1.025,00 €	● FA53905633-300	1.025,00 €

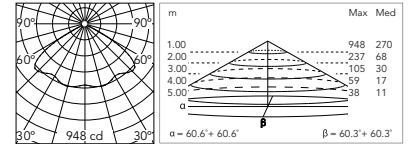

@ 3000K

Asymmetric Optic

Power Led: 39W - 4122 lm ≠ OUTPUT 3173 lm - 2700K/CRI 80 - 220÷240V / 39W - 4416 lm ≠ OUTPUT 3400 lm - 3000K/CRI 80 - 220÷240V / 39W - 4563 lm ≠ OUTPUT 3513 lm - 4000K/CRI 80 - 220÷240V

2700K

3000K

4000K

Non Dimmable		Non Dimmable		Non Dimmable	
● FA53913606	880,00 €	● FA53915406	880,00 €	● FA53917206	880,00 €
● FA53913633	880,00 €	● FA53915433	880,00 €	● FA53917233	880,00 €
1-10V		1-10V		1-10V	
● FA53913606-310	1.001,00 €	● FA53915406-310	1.001,00 €	● FA53917206-310	1.001,00 €
● FA53913633-310	1.001,00 €	● FA53915433-310	1.001,00 €	● FA53917233-310	1.001,00 €
Dali		Dali		Dali	
● FA53913606-300	1.001,00 €	● FA53915406-300	1.001,00 €	● FA53917206-300	1.001,00 €
● FA53913633-300	1.001,00 €	● FA53915433-300	1.001,00 €	● FA53917233-300	1.001,00 €

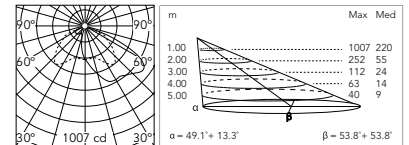

@ 3000K

Street Light Optic

Power Led: 39W - 4122 lm ≠ OUTPUT 3102 lm - 2700K/CRI 80 - 220÷240V / 39W - 4416 lm ≠ OUTPUT 3323 lm - 3000K/CRI 80 - 220÷240V / 39W - 4563 lm ≠ OUTPUT 3434 lm - 4000K/CRI 80 - 220÷240V

2700K

3000K

4000K

Non Dimmable		Non Dimmable		Non Dimmable	
● FA53909206	904,00 €	● FA53906006	904,00 €	● FA53905906	904,00 €
● FA53909233	904,00 €	● FA53906033	904,00 €	● FA53905933	904,00 €
1-10V		1-10V		1-10V	
● FA53909206-310	1.025,00 €	● FA53906006-310	1.025,00 €	● FA53905906-310	1.025,00 €
● FA53909233-310	1.025,00 €	● FA53906033-310	1.025,00 €	● FA53905933-310	1.025,00 €
Dali		Dali		Dali	
● FA53909206-300	1.025,00 €	● FA53906006-300	1.025,00 €	● FA53905906-300	1.025,00 €
● FA53909233-300	1.025,00 €	● FA53906033-300	1.025,00 €	● FA53905933-300	1.025,00 €

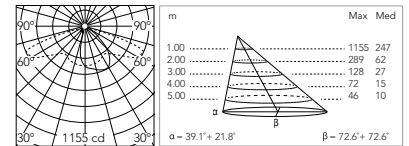

@ 3000K

Street Light Optic (Foot and Cycle Paths)

Power Led: 39W - 4122 lm ≠ OUTPUT 3130 lm - 2700K/CRI 80 - 220÷240V / 39W - 4416 lm ≠ OUTPUT 3354 lm - 3000K/CRI 80 - 220÷240V / 39W - 4563 lm ≠ OUTPUT 3466 lm - 4000K/CRI 80 - 220÷240V

2700K

3000K

4000K

Non Dimmable		Non Dimmable		Non Dimmable	
● FA53909406	904,00 €	● FA53906306	904,00 €	● FA53906206	904,00 €
● FA53909433	904,00 €	● FA53906333	904,00 €	● FA53906233	904,00 €
1-10V		1-10V		1-10V	
● FA53909406-310	1.025,00 €	● FA53906306-310	1.025,00 €	● FA53906206-310	1.025,00 €
● FA53909433-310	1.025,00 €	● FA53906333-310	1.025,00 €	● FA53906233-310	1.025,00 €
Dali		Dali		Dali	
● FA53909406-300	1.025,00 €	● FA53906306-300	1.025,00 €	● FA53906206-300	1.025,00 €
● FA53909433-300	1.025,00 €	● FA53906333-300	1.025,00 €	● FA53906233-300	1.025,00 €

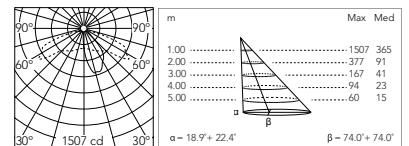

@ 3000K

Dooku 400 - Double Top Pole ø102

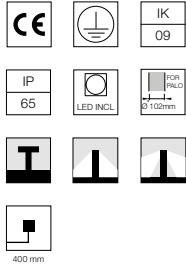
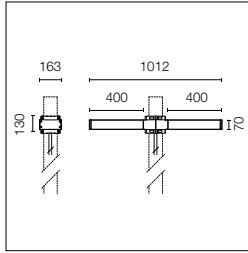

Source LED incluse. Source d'alimentation électrique intégrée 220-240V ON/OFF et intensité réglable entre 1 y 10V ou DALI. Équerre de maintien incluse. Équipé d'un câble sortant de 400 mm en néoprène et des connecteurs IP68. Prise individuelle pour poteaux de 102 mm de diamètre. Le poteau est à commander séparément. Version Smart-City disponible sur demande.

LED source included. Integrated power supply 220-240V ON/OFF and dimmable 1-10V or DALI. Fixing bracket included. Equipped with a 400mm protruding neoprene cable section and IP68 connectors. Double socket for 102mm diameter post. The post must be ordered separately. Smart-City version available upon request.

Optic 120° (Wide Spaces - Public Areas - Parking Areas)

2200K disponible sur demande. 2200K available on request.

Power Led: 39W - 2x4122 lm ≠ OUTPUT 2x3389 lm - 2700K/CRI 80 - 220÷240V / 39W - 2x4416 lm ≠ OUTPUT 2x3631 lm - 3000K/CRI 80 - 220÷240V / 39W - 2x4563 lm ≠ OUTPUT 2x3752 lm - 4000K/CRI 80 - 220÷240V

2700K

3000K

4000K

2700K		3000K		4000K	
Non Dimmable		Non Dimmable		Non Dimmable	
● FA53909606	1.802,00 €	● FA53906606	1.802,00 €	● FA53906506	1.802,00 €
● FA53909633	1.802,00 €	● FA53906633	1.802,00 €	● FA53906533	1.802,00 €
1-10V		1-10V		1-10V	
● FA53909606-310	2.045,00 €	● FA53906606-310	2.045,00 €	● FA53906506-310	2.045,00 €
● FA53909633-310	2.045,00 €	● FA53906633-310	2.045,00 €	● FA53906533-310	2.045,00 €
Dali		Dali		Dali	
● FA53909606-300	2.045,00 €	● FA53906606-300	2.045,00 €	● FA53906506-300	2.045,00 €
● FA53909633-300	2.045,00 €	● FA53906633-300	2.045,00 €	● FA53906533-300	2.045,00 €

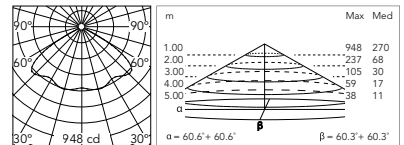
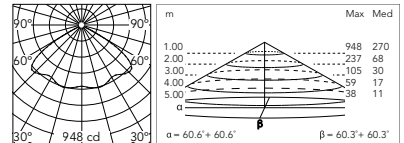

@ 3000K

Asymmetric Optic

Power Led: 39W - 2x4122 lm ≠ OUTPUT 2x3173 lm - 2700K/CRI 80 - 220÷240V / 39W - 2x4416 lm ≠ OUTPUT 2x3400 lm - 3000K/CRI 80 - 220÷240V / 39W - 2x4563 lm ≠ OUTPUT 2x3513 lm - 4000K/CRI 80 - 220÷240V

2700K

3000K

4000K

2700K		3000K		4000K	
Non Dimmable		Non Dimmable		Non Dimmable	
● FA53913806	1.758,00 €	● FA53915606	1.758,00 €	● FA53917406	1.758,00 €
● FA53913833	1.758,00 €	● FA53915633	1.758,00 €	● FA53917433	1.758,00 €
1-10V		1-10V		1-10V	
● FA53913806-310	1.998,00 €	● FA53915606-310	1.998,00 €	● FA53917406-310	1.998,00 €
● FA53913833-310	1.998,00 €	● FA53915633-310	1.998,00 €	● FA53917433-310	1.998,00 €
Dali		Dali		Dali	
● FA53913806-300	1.998,00 €	● FA53915606-300	1.998,00 €	● FA53917406-300	1.998,00 €
● FA53913833-300	1.998,00 €	● FA53915633-300	1.998,00 €	● FA53917433-300	1.998,00 €

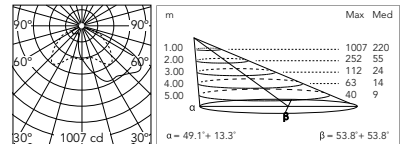
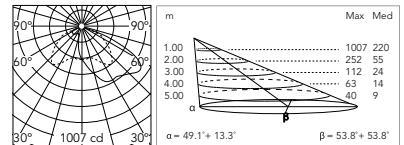

@ 3000K

Street Light Optic

Power Led: 39W - 2x4122 lm ≠ OUTPUT 2x3102 lm - 2700K/CRI 80 - 220÷240V / 39W - 2x4416 lm ≠ OUTPUT 2x3323 lm - 3000K/CRI 80 - 220÷240V / 39W - 2x4563 lm ≠ OUTPUT 2x3434 lm - 4000K/CRI 80 - 220÷240V

2700K

3000K

4000K

2700K		3000K		4000K	
Non Dimmable		Non Dimmable		Non Dimmable	
● FA53909806	1.802,00 €	● FA53906906	1.802,00 €	● FA53906806	1.802,00 €
● FA53909833	1.802,00 €	● FA53906933	1.802,00 €	● FA53906833	1.802,00 €
1-10V		1-10V		1-10V	
● FA53909806-310	2.045,00 €	● FA53906906-310	2.045,00 €	● FA53906806-310	2.045,00 €
● FA53909833-310	2.045,00 €	● FA53906933-310	2.045,00 €	● FA53906833-310	2.045,00 €
Dali		Dali		Dali	
● FA53909806-300	2.045,00 €	● FA53906906-300	2.045,00 €	● FA53906806-300	2.045,00 €
● FA53909833-300	2.045,00 €	● FA53906933-300	2.045,00 €	● FA53906833-300	2.045,00 €

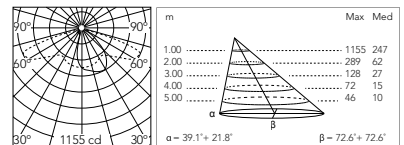
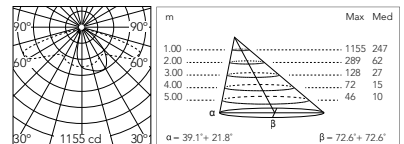

@ 3000K

Street Light Optic (Foot and Cycle Paths)

Power Led: 39W - 2x4122 lm ≠ OUTPUT 2x3130 lm - 2700K/CRI 80 - 220÷240V / 39W - 2x4416 lm ≠ OUTPUT 2x3354 lm - 3000K/CRI 80 - 220÷240V / 39W - 2x4563 lm ≠ OUTPUT 2x3466 lm - 4000K/CRI 80 - 220÷240V

2700K

3000K

4000K

2700K		3000K		4000K	
Non Dimmable		Non Dimmable		Non Dimmable	
● FA53910006	1.802,00 €	● FA53907206	1.802,00 €	● FA53907106	1.802,00 €
● FA53910033	1.802,00 €	● FA53907233	1.802,00 €	● FA53907133	1.802,00 €
1-10V		1-10V		1-10V	
● FA53910006-310	2.045,00 €	● FA53907206-310	2.045,00 €	● FA53907106-310	2.045,00 €
● FA53910033-310	2.045,00 €	● FA53907233-310	2.045,00 €	● FA53907133-310	2.045,00 €
Dali		Dali		Dali	
● FA53910006-300	2.045,00 €	● FA53907206-300	2.045,00 €	● FA53907106-300	2.045,00 €
● FA53910033-300	2.045,00 €	● FA53907233-300	2.045,00 €	● FA53907133-300	2.045,00 €

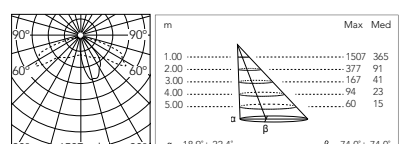
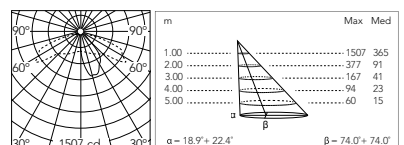

@ 3000K

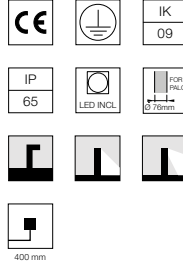
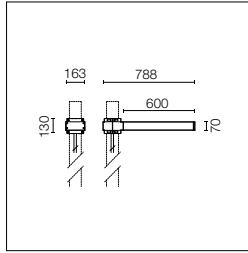

Source LED incluse. Source d'alimentation électrique intégrée 220-240V ON/OFF et intensité réglable entre 1 y 10V ou DALI. Équerre de maintien incluse. Équipé d'un câble sortant de 400 mm en néoprène et des connecteurs IP68. Prise individuelle pour poteaux de 76mm de diamètre. Le poteau est à commander séparément. Version Smart-City disponible sur demande.

LED source included. Integrated power supply 220-240V ON/OFF and dimmable 1-10V or DALI. Fixing bracket included. Equipped with a 400mm protruding neoprene cable section and IP68 connectors. Smart-City version available upon request. Single socket for 76mm diameter post. The post must be ordered separately. Smart-City version available upon request.

Optic 120° (Wide Spaces - Public Areas - Parking Areas)

2200K disponible sur demande.

2200K available on request.

Power Led: 78W - 8243 lm ≠ OUTPUT 6779 lm - 2700K/CRI 80 - 220÷240V / 78W - 8832 lm ≠ OUTPUT 7263 lm - 3000K/CRI 80 - 220÷240V / 78W - 9126 lm ≠ OUTPUT 7505 lm - 4000K/CRI 80 - 220÷240V

2700K

Non Dimmable

- FA53910206 1.352,00 €
- FA53910233 1.352,00 €
- FA53910206-310 1.605,00 €
- FA53910233-310 1.605,00 €
- FA53910206-300 1.605,00 €
- FA53910233-300 1.605,00 €

3000K

Non Dimmable

- FA53900306 1.352,00 €
- FA53900333 1.352,00 €
- FA53900306-310 1.605,00 €
- FA53900333-310 1.605,00 €
- FA53900306-300 1.605,00 €
- FA53900333-300 1.605,00 €

4000K

Non Dimmable

- FA53900206 1.352,00 €
- FA53900233 1.352,00 €
- FA53900206-310 1.605,00 €
- FA53900233-310 1.605,00 €
- FA53900206-300 1.605,00 €
- FA53900233-300 1.605,00 €

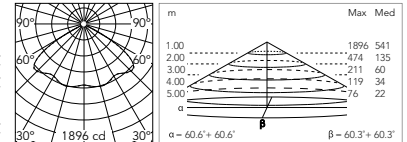

@ 3000K

Asymmetric Optic

Power Led: 78W - 8243 lm ≠ OUTPUT 6347 lm - 2700K/CRI 80 - 220÷240V / 78W - 8832 lm ≠ OUTPUT 6800 lm - 3000K/CRI 80 - 220÷240V / 78W - 9126 lm ≠ OUTPUT 7027 lm - 4000K/CRI 80 - 220÷240V

2700K

Non Dimmable

- FA53914006 1.319,00 €
- FA53914033 1.319,00 €
- FA53914006-310 1.571,00 €
- FA53914033-310 1.571,00 €
- FA53914006-300 1.571,00 €
- FA53914033-300 1.571,00 €

3000K

Non Dimmable

- FA53915806 1.319,00 €
- FA53915833 1.319,00 €
- FA53915806-310 1.571,00 €
- FA53915833-310 1.571,00 €
- FA53915806-300 1.571,00 €
- FA53915833-300 1.571,00 €

4000K

Non Dimmable

- FA53917606 1.319,00 €
- FA53917633 1.319,00 €
- FA53917606-310 1.571,00 €
- FA53917633-310 1.571,00 €
- FA53917606-300 1.571,00 €
- FA53917633-300 1.571,00 €

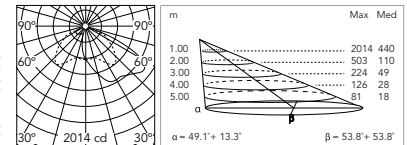

@ 3000K

Street Light Optic

Power Led: 78W - 8243 lm ≠ OUTPUT 6203 lm - 2700K/CRI 80 - 220÷240V / 78W - 8832 lm ≠ OUTPUT 6646 lm - 3000K/CRI 80 - 220÷240V / 78W - 9126 lm ≠ OUTPUT 6868 lm - 4000K/CRI 80 - 220÷240V

2700K

Non Dimmable

- FA53910406 1.352,00 €
- FA53910433 1.352,00 €
- FA53910406-310 1.605,00 €
- FA53910433-310 1.605,00 €
- FA53910406-300 1.605,00 €
- FA53910433-300 1.605,00 €

3000K

Non Dimmable

- FA53900606 1.352,00 €
- FA53900633 1.352,00 €
- FA53900606-310 1.605,00 €
- FA53900633-310 1.605,00 €
- FA53900606-300 1.605,00 €
- FA53900633-300 1.605,00 €

4000K

Non Dimmable

- FA53900506 1.352,00 €
- FA53900533 1.352,00 €
- FA53900506-310 1.605,00 €
- FA53900533-310 1.605,00 €
- FA53900506-300 1.605,00 €
- FA53900533-300 1.605,00 €

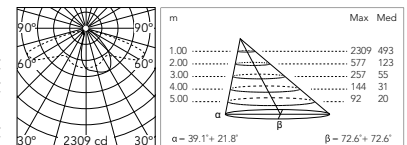

@ 3000K

Street Light Optic (Foot and Cycle Paths)

Power Led: 78W - 8243 lm ≠ OUTPUT 6261 lm - 2700K/CRI 80 - 220÷240V / 78W - 8832 lm ≠ OUTPUT 6708 lm - 3000K/CRI 80 - 220÷240V / 78W - 9126 lm ≠ OUTPUT 6932 lm - 4000K/CRI 80 - 220÷240V

2700K

Non Dimmable

- FA53910606 1.352,00 €
- FA53910633 1.352,00 €
- FA53910606-310 1.605,00 €
- FA53910633-310 1.605,00 €
- FA53910606-300 1.605,00 €
- FA53910633-300 1.605,00 €

3000K

Non Dimmable

- FA53900906 1.352,00 €
- FA53900933 1.352,00 €
- FA53900906-310 1.605,00 €
- FA53900933-310 1.605,00 €
- FA53900906-300 1.605,00 €
- FA53900933-300 1.605,00 €

4000K

Non Dimmable

- FA53900806 1.352,00 €
- FA53900833 1.352,00 €
- FA53900806-310 1.605,00 €
- FA53900833-310 1.605,00 €
- FA53900806-300 1.605,00 €
- FA53900833-300 1.605,00 €

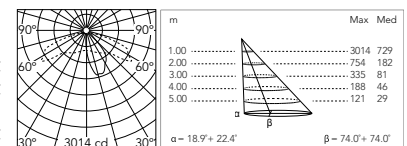

@ 3000K

Dooku 600 - Double Top Pole ø76

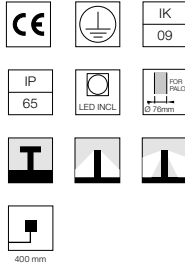
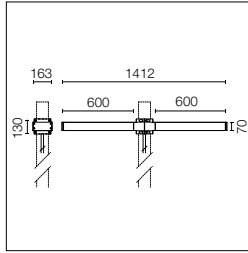

Source LED incluse. Source d'alimentation électrique intégrée 220-240V ON/OFF et intensité réglable entre 1 y 10V ou DALI. Équerre de maintien incluse. Équipé d'un câble sortant de 400 mm en néoprène et des connecteurs IP68. Prise individuelle pour poteaux de 76 mm de diamètre. Le poteau est à commander séparément. Version Smart-City disponible sur demande.

LED source included. Integrated power supply 220-240V ON/OFF and dimmable 1-10V or DALI. Fixing bracket included. Equipped with a 400mm protruding neoprene cable section and IP68 connectors. Double socket for 76mm diameter post. The post must be ordered separately. Smart-City version available upon request.

Optic 120° (Wide Spaces - Public Areas - Parking Areas)

2200K disponible sur demande. 2200K available on request.

Power Led: 78W - 2x8243 lm ≠ OUTPUT 2x6779 lm - 2700K/CRI 80 - 220÷240V / 78W - 2x8832 lm ≠ OUTPUT 2x7263 lm - 3000K/CRI 80 - 220÷240V / 78W - 2x9126 lm ≠ OUTPUT 2x7505 lm - 4000K/CRI 80 - 220÷240V

2700K		3000K		4000K	
Non Dimmable		Non Dimmable		Non Dimmable	
● FA53910806	2.701,00 €	● FA53901206	2.701,00 €	● FA53901106	2.701,00 €
● FA53910833	2.701,00 €	● FA53901233	2.701,00 €	● FA53901133	2.701,00 €
1-10V					
● FA53910806-310	3.205,00 €	● FA53901206-310	3.205,00 €	● FA53901106-310	3.205,00 €
● FA53910833-310	3.205,00 €	● FA53901233-310	3.205,00 €	● FA53901133-310	3.205,00 €
Dali					
● FA53910806-300	3.205,00 €	● FA53901206-300	3.205,00 €	● FA53901106-300	3.205,00 €
● FA53910833-300	3.205,00 €	● FA53901233-300	3.205,00 €	● FA53901133-300	3.205,00 €

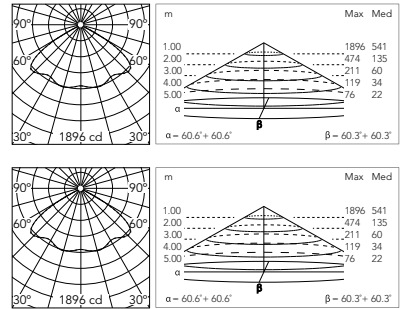

Asymmetric Optic

Power Led: 78W - 2x8243 lm ≠ OUTPUT 2x6347 lm - 2700K/CRI 80 - 220÷240V / 78W - 2x8832 lm ≠ OUTPUT 2x6800 lm - 3000K/CRI 80 - 220÷240V / 78W - 2x9126 lm ≠ OUTPUT 2x7027 lm - 4000K/CRI 80 - 220÷240V

2700K		3000K		4000K	
Non Dimmable		Non Dimmable		Non Dimmable	
● FA53914206	2.636,00 €	● FA53916006	2.636,00 €	● FA53917806	2.636,00 €
● FA53914233	2.636,00 €	● FA53916033	2.636,00 €	● FA53917833	2.636,00 €
1-10V					
● FA53914206-310	3.138,00 €	● FA53916006-310	3.138,00 €	● FA53917806-310	3.138,00 €
● FA53914233-310	3.138,00 €	● FA53916033-310	3.138,00 €	● FA53917833-310	3.138,00 €
Dali					
● FA53914206-300	3.138,00 €	● FA53916006-300	3.138,00 €	● FA53917806-300	3.138,00 €
● FA53914233-300	3.138,00 €	● FA53916033-300	3.138,00 €	● FA53917833-300	3.138,00 €

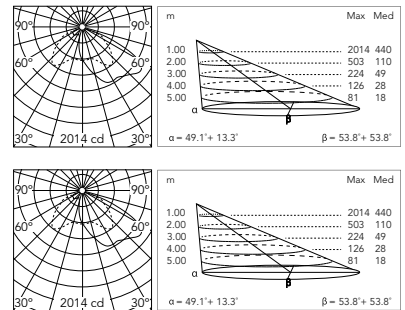

Street Light Optic

Power Led: 78W - 2x8243 lm ≠ OUTPUT 2x6203 lm - 2700K/CRI 80 - 220÷240V / 78W - 2x8832 lm ≠ OUTPUT 2x6646 lm - 3000K/CRI 80 - 220÷240V / 78W - 2x9126 lm ≠ OUTPUT 2x6868 lm - 4000K/CRI 80 - 220÷240V

2700K		3000K		4000K	
Non Dimmable		Non Dimmable		Non Dimmable	
● FA53911006	2.701,00 €	● FA53901506	2.701,00 €	● FA53901406	2.701,00 €
● FA53911033	2.701,00 €	● FA53901533	2.701,00 €	● FA53901433	2.701,00 €
1-10V					
● FA53911006-310	3.205,00 €	● FA53901506-310	3.205,00 €	● FA53901406-310	3.205,00 €
● FA53911033-310	3.205,00 €	● FA53901533-310	3.205,00 €	● FA53901433-310	3.205,00 €
Dali					
● FA53911006-300	3.205,00 €	● FA53901506-300	3.205,00 €	● FA53901406-300	3.205,00 €
● FA53911033-300	3.205,00 €	● FA53901533-300	3.205,00 €	● FA53901433-300	3.205,00 €

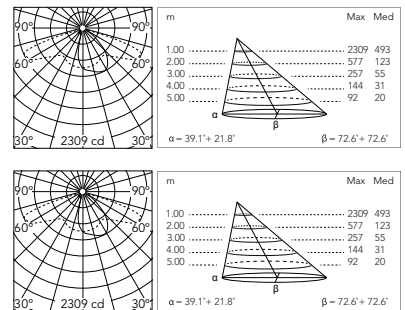

Street Light Optic (Foot and Cycle Paths)

Power Led: 78W - 2x8243 lm ≠ OUTPUT 2x6261 lm - 2700K/CRI 80 - 220÷240V / 78W - 2x8832 lm ≠ OUTPUT 2x6708 lm - 3000K/CRI 80 - 220÷240V / 78W - 2x9126 lm ≠ OUTPUT 2x6932 lm - 4000K/CRI 80 - 220÷240V

2700K		3000K		4000K	
Non Dimmable		Non Dimmable		Non Dimmable	
● FA53911206	2.701,00 €	● FA53901806	2.701,00 €	● FA53901706	2.701,00 €
● FA53911233	2.701,00 €	● FA53901833	2.701,00 €	● FA53901733	2.701,00 €
1-10V					
● FA53911206-310	3.205,00 €	● FA53901806-310	3.205,00 €	● FA53901706-310	3.205,00 €
● FA53911233-310	3.205,00 €	● FA53901833-310	3.205,00 €	● FA53901733-310	3.205,00 €
Dali					
● FA53911206-300	3.205,00 €	● FA53901806-300	3.205,00 €	● FA53901706-300	3.205,00 €
● FA53911233-300	3.205,00 €	● FA53901833-300	3.205,00 €	● FA53901733-300	3.205,00 €

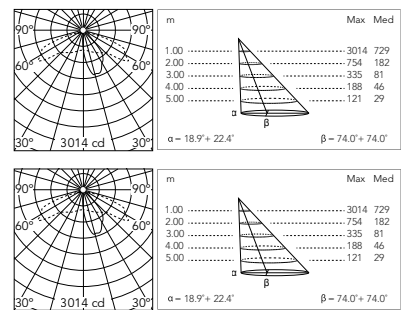

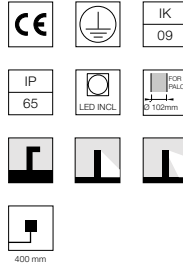
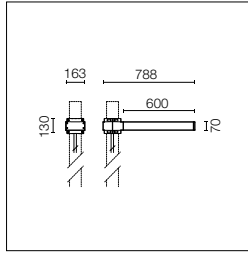

Source LED incluse. Source d'alimentation électrique intégrée 220-240V ON/OFF et intensité réglable entre 1 y 10V ou DALI. Équerre de maintien incluse. Équipé d'un câble sortant de 400 mm en néoprène et des connecteurs IP68. Prise individuelle pour poteaux de 102mm de diamètre. Le poteau est à commander séparément. Version Smart-City disponible sur demande.

LED source included. Integrated power supply 220-240V ON/OFF and dimmable 1-10V or DALI. Fixing bracket included. Equipped with a 400mm protruding neoprene cable section and IP68 connectors. Smart-City version available upon request. Single socket for 102mm diameter post. The post must be ordered separately. Smart-City version available upon request.

Optic 120° (Wide Spaces - Public Areas - Parking Areas)

2200K disponible sur demande.

2200K available on request.

Power Led: 78W - 8243 lm ≠ OUTPUT 6779 lm - 2700K/CRI 80 - 220÷240V / 78W - 8832 lm ≠ OUTPUT 7263 lm - 3000K/CRI 80 - 220÷240V / 78W - 9126 lm ≠ OUTPUT 7505 lm - 4000K/CRI 80 - 220÷240V

2700K

Non Dimmable

● FA53911406	1.352,00 €
● FA53911433	1.352,00 €
1-10V	
● FA53911406-310	1.605,00 €
● FA53911433-310	1.605,00 €
Dali	
● FA53911406-300	1.605,00 €
● FA53911433-300	1.605,00 €

3000K

Non Dimmable

● FA53902106	1.352,00 €
● FA53902133	1.352,00 €
1-10V	
● FA53902106-310	1.605,00 €
● FA53902133-310	1.605,00 €
Dali	
● FA53902106-300	1.605,00 €
● FA53902133-300	1.605,00 €

4000K

Non Dimmable

● FA53902006	1.352,00 €
● FA53902033	1.352,00 €
1-10V	
● FA53902006-310	1.605,00 €
● FA53902033-310	1.605,00 €
Dali	
● FA53902006-300	1.605,00 €
● FA53902033-300	1.605,00 €

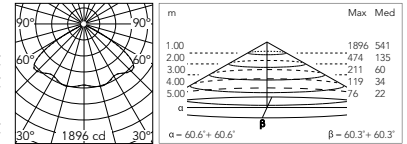

@ 3000K

Asymmetric Optic

Power Led: 78W - 8243 lm ≠ OUTPUT 6347 lm - 2700K/CRI 80 - 220÷240V / 78W - 8832 lm ≠ OUTPUT 6800 lm - 3000K/CRI 80 - 220÷240V / 78W - 9126 lm ≠ OUTPUT 7027 lm - 4000K/CRI 80 - 220÷240V

2700K

Non Dimmable

● FA53914406	1.319,00 €
● FA53914433	1.319,00 €
1-10V	
● FA53914406-310	1.571,00 €
● FA53914433-310	1.571,00 €
Dali	
● FA53914406-300	1.571,00 €
● FA53914433-300	1.571,00 €

3000K

Non Dimmable

● FA53916206	1.319,00 €
● FA53916233	1.319,00 €
1-10V	
● FA53916206-310	1.571,00 €
● FA53916233-310	1.571,00 €
Dali	
● FA53916206-300	1.571,00 €
● FA53916233-300	1.571,00 €

4000K

Non Dimmable

● FA53918006	1.319,00 €
● FA53918033	1.319,00 €
1-10V	
● FA53918006-310	1.571,00 €
● FA53918033-310	1.571,00 €
Dali	
● FA53918006-300	1.571,00 €
● FA53918033-300	1.571,00 €

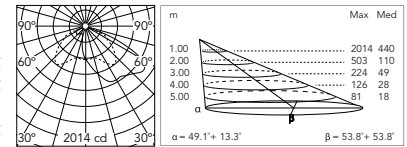

@ 3000K

Street Light Optic

Power Led: 78W - 8243 lm ≠ OUTPUT 6203 lm - 2700K/CRI 80 - 220÷240V / 78W - 8832 lm ≠ OUTPUT 6646 lm - 3000K/CRI 80 - 220÷240V / 78W - 9126 lm ≠ OUTPUT 6868 lm - 4000K/CRI 80 - 220÷240V

2700K

Non Dimmable

● FA53911606	1.352,00 €
● FA53911633	1.352,00 €
1-10V	
● FA53911606-310	1.605,00 €
● FA53911633-310	1.605,00 €
Dali	
● FA53911606-300	1.605,00 €
● FA53911633-300	1.605,00 €

3000K

Non Dimmable

● FA53902406	1.352,00 €
● FA53902433	1.352,00 €
1-10V	
● FA53902406-310	1.605,00 €
● FA53902433-310	1.605,00 €
Dali	
● FA53902406-300	1.605,00 €
● FA53902433-300	1.605,00 €

4000K

Non Dimmable

● FA53902306	1.352,00 €
● FA53902333	1.352,00 €
1-10V	
● FA53902306-310	1.605,00 €
● FA53902333-310	1.605,00 €
Dali	
● FA53902306-300	1.605,00 €
● FA53902333-300	1.605,00 €

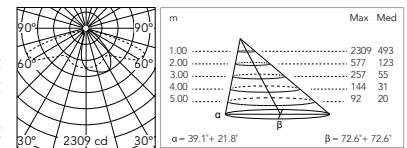

@ 3000K

Street Light Optic (Foot and Cycle Paths)

Power Led: 78W - 8243 lm ≠ OUTPUT 6261 lm - 2700K/CRI 80 - 220÷240V / 78W - 8832 lm ≠ OUTPUT 6708 lm - 3000K/CRI 80 - 220÷240V / 78W - 9126 lm ≠ OUTPUT 6932 lm - 4000K/CRI 80 - 220÷240V

2700K

Non Dimmable

● FA53911806	1.352,00 €
● FA53911833	1.352,00 €
1-10V	
● FA53911806-310	1.605,00 €
● FA53911833-310	1.605,00 €
Dali	
● FA53911806-300	1.605,00 €
● FA53911833-300	1.605,00 €

3000K

Non Dimmable

● FA53902706	1.352,00 €
● FA53902733	1.352,00 €
1-10V	
● FA53902706-310	1.605,00 €
● FA53902733-310	1.605,00 €
Dali	
● FA53902706-300	1.605,00 €
● FA53902733-300	1.605,00 €

4000K

Non Dimmable

● FA53902606	1.352,00 €
● FA53902633	1.352,00 €
1-10V	
● FA53902606-310	1.605,00 €
● FA53902633-310	1.605,00 €
Dali	
● FA53902606-300	1.605,00 €
● FA53902633-300	1.605,00 €

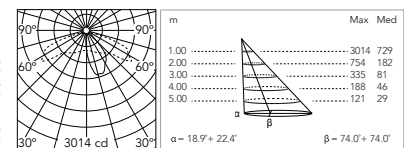

@ 3000K

Dooku 600 - Double Top Pole ø102

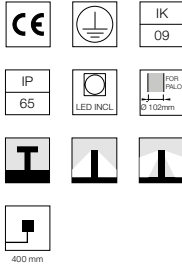
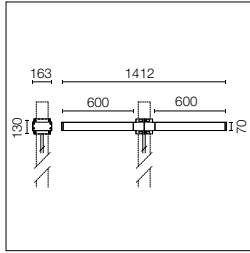

Source LED incluse. Source d'alimentation électrique intégrée 220-240V ON/OFF et intensité réglable entre 1 y 10V ou DALI. Équerre de maintien incluse. Équipé d'un câble sortant de 400 mm en néoprène et des connecteurs IP68. Prise individuelle pour poteaux de 102 mm de diamètre. Le poteau est à commander séparément. Version Smart-City disponible sur demande.

LED source included. Integrated power supply 220-240V ON/OFF and dimmable 1-10V or DALI. Fixing bracket included. Equipped with a 400mm protruding neoprene cable section and IP68 connectors. Double socket for 102mm diameter post. The post must be ordered separately. Smart-City version available upon request.

Optic 120° (Wide Spaces - Public Areas - Parking Areas)

2200K disponible sur demande. 2200K available on request.

Power Led: 78W - 2x8243 lm ≠ OUTPUT 2x6779 lm - 2700K/CRI 80 - 220÷240V / 78W - 2x8832 lm ≠ OUTPUT 2x7263 lm - 3000K/CRI 80 - 220÷240V / 78W - 2x9126 lm ≠ OUTPUT 2x7505 lm - 4000K/CRI 80 - 220÷240V

2700K

Non Dimmable	
● FA53912006	2.701,00 €
● FA53912033	2.701,00 €
1-10V	
● FA53912006-310	3.205,00 €
● FA53912033-310	3.205,00 €
Dali	
● FA53912006-300	3.205,00 €
● FA53912033-300	3.205,00 €

3000K

Non Dimmable	
● FA53903006	2.701,00 €
● FA53903033	2.701,00 €
1-10V	
● FA53903006-310	3.205,00 €
● FA53903033-310	3.205,00 €
Dali	
● FA53903006-300	3.205,00 €
● FA53903033-300	3.205,00 €

4000K

Non Dimmable	
● FA53902906	2.701,00 €
● FA53902933	2.701,00 €
1-10V	
● FA53902906-310	3.205,00 €
● FA53902933-310	3.205,00 €
Dali	
● FA53902906-300	3.205,00 €
● FA53902933-300	3.205,00 €

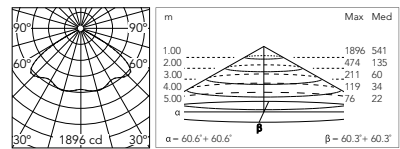
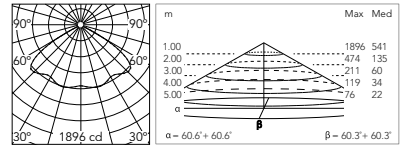

Asymmetric Optic

Power Led: 78W - 2x8243 lm ≠ OUTPUT 2x6347 lm - 2700K/CRI 80 - 220÷240V / 78W - 2x8832 lm ≠ OUTPUT 2x6800 lm - 3000K/CRI 80 - 220÷240V / 78W - 2x9126 lm ≠ OUTPUT 2x7027 lm - 4000K/CRI 80 - 220÷240V

2700K

Non Dimmable	
● FA53914606	2.636,00 €
● FA53914633	2.636,00 €
1-10V	
● FA53914606-310	3.138,00 €
● FA53914633-310	3.138,00 €
Dali	
● FA53914606-300	3.138,00 €
● FA53914633-300	3.138,00 €

3000K

Non Dimmable	
● FA53916406	2.636,00 €
● FA53916433	2.636,00 €
1-10V	
● FA53916406-310	3.138,00 €
● FA53916433-310	3.138,00 €
Dali	
● FA53916406-300	3.138,00 €
● FA53916433-300	3.138,00 €

4000K

Non Dimmable	
● FA53918206	2.636,00 €
● FA53918233	2.636,00 €
1-10V	
● FA53918206-310	3.138,00 €
● FA53918233-310	3.138,00 €
Dali	
● FA53918206-300	3.138,00 €
● FA53918233-300	3.138,00 €

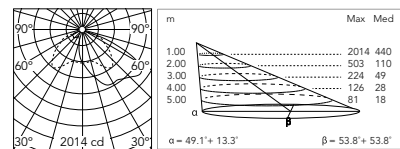
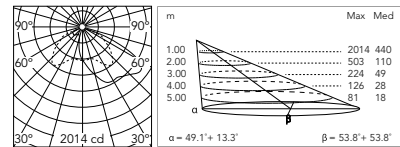

Street Light Optic

Power Led: 78W - 2x8243 lm ≠ OUTPUT 2x6203 lm - 2700K/CRI 80 - 220÷240V / 78W - 2x8832 lm ≠ OUTPUT 2x6646 lm - 3000K/CRI 80 - 220÷240V / 78W - 2x9126 lm ≠ OUTPUT 2x6868 lm - 4000K/CRI 80 - 220÷240V

2700K

Non Dimmable	
● FA53912206	2.701,00 €
● FA53912233	2.701,00 €
1-10V	
● FA53912206-310	3.205,00 €
● FA53912233-310	3.205,00 €
Dali	
● FA53912206-300	3.205,00 €
● FA53912233-300	3.205,00 €

3000K

Non Dimmable	
● FA53903306	2.701,00 €
● FA53903333	2.701,00 €
1-10V	
● FA53903306-310	3.205,00 €
● FA53903333-310	3.205,00 €
Dali	
● FA53903306-300	3.205,00 €
● FA53903333-300	3.205,00 €

4000K

Non Dimmable	
● FA53903206	2.701,00 €
● FA53903233	2.701,00 €
1-10V	
● FA53903206-310	3.205,00 €
● FA53903233-310	3.205,00 €
Dali	
● FA53903206-300	3.205,00 €
● FA53903233-300	3.205,00 €

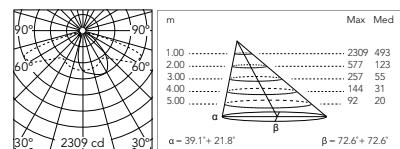
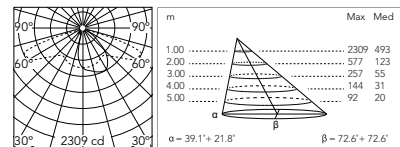

Street Light Optic (Foot and Cycle Paths)

Power Led: 78W - 2x8243 lm ≠ OUTPUT 2x6261 lm - 2700K/CRI 80 - 220÷240V / 78W - 2x8832 lm ≠ OUTPUT 2x6708 lm - 3000K/CRI 80 - 220÷240V / 78W - 2x9126 lm ≠ OUTPUT 2x6932 lm - 4000K/CRI 80 - 220÷240V

2700K

Non Dimmable	
● FA53912406	2.701,00 €
● FA53912433	2.701,00 €
1-10V	
● FA53912406-310	3.205,00 €
● FA53912433-310	3.205,00 €
Dali	
● FA53912406-300	3.205,00 €
● FA53912433-300	3.205,00 €

3000K

Non Dimmable	
● FA53903606	2.701,00 €
● FA53903633	2.701,00 €
1-10V	
● FA53903606-310	3.205,00 €
● FA53903633-310	3.205,00 €
Dali	
● FA53903606-300	3.205,00 €
● FA53903633-300	3.205,00 €

4000K

Non Dimmable	
● FA53903506	2.701,00 €
● FA53903533	2.701,00 €
1-10V	
● FA53903506-310	3.205,00 €
● FA53903533-310	3.205,00 €
Dali	
● FA53903506-300	3.205,00 €
● FA53903533-300	3.205,00 €

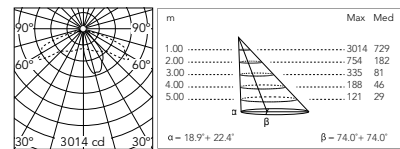
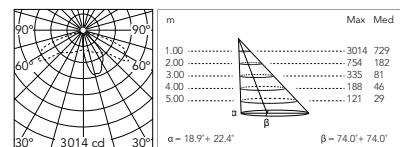

Dooku / Ø 76mm - Poles

Avec base et boîte de dérivation.

With Base and Access Door.
With Terminal Block 4x1,5-16mmq.



H 3500mm

- FA24806 702,00 €
- FA24833 702,00 €

H 4500mm

- FA24906 852,00 €
- FA24933 852,00 €

Encastrable (+500 mm en dessous du sol)
Avec boîte de dérivation

In-Ground (+500 mm Root) With Access Door
With Terminal Block 4x1,5-16mmq

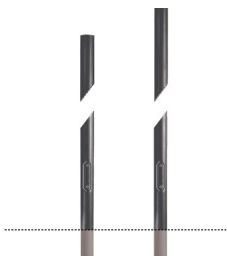

H 3500mm

- FA25006 644,00 €
- FA25033 644,00 €

H 4500mm

- FA25106 759,00 €
- FA25133 759,00 €

Dooku / Ø 102mm - Poles

Avec base et boîte de dérivation.

With Base and Access Door .
With Terminal Block 4x1,5-16mmq.



H 4000mm

- FA414006 852,00 €
- FA414033 852,00 €

H 5000mm

- FA415006 978,00 €
- FA415033 978,00 €

Encastrable (+500 mm en dessous du sol)
Avec boîte de dérivation

In-Ground (+500 mm Root) With Access Door
With Terminal Block 4x1,5-16mmq

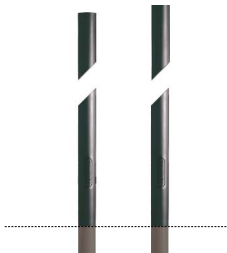

H 4000mm

- FA414506 773,00 €
- FA414533 773,00 €

H 5000mm

- FA415506 932,00 €
- FA415533 932,00 €

Dooku: Accessoires / Accessories

Plaque de boulons.

Base plate with bolt.

FA116

97,00 €

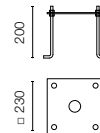

Dispositif de protection contre les surtensions. 275Vac. Courant de décharge maximal 10KA (8/20µs). Courant de fonctionnement maximal 5A. Adapté pour les connexions en séries. IP66.

Surge protection device. 275Vac. Maximum discharge current 10KA (8/20µs). Maximum operating current 5A. Suitable for series connection. IP66.

F990E00A000

116,00 €

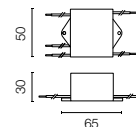

Classe d'isolation des lampes / Luminaires classification



Classe I: Lampe dont la protection contre les décharges électriques ne se base pas uniquement sur l'isolation de base de l'appareil, mais sur un autre système de sécurité qui consiste en un branchement des composants conducteurs accessibles à un conducteur de sécurité (mise à terre) faisant partie de l'installation électrique fixe.

Class I: Luminaire in which protection against electrical shocks is not just based on the basic insulation but also on an additional safety precautions consisting of connecting the accesible conductive parts to a safety conductor (earth).



Classe II: Lampe dont la protection contre les décharges électriques ne se base pas uniquement sur l'isolation de base de l'appareil, mais sur une autre mesure de sécurité qui consiste en une double isolation renforcée sans dispositif de mise à terre.

Class II: Luminaire in which protection against electrical shocks is not just based on the basic insulation but also on an additional safety precautions consisting of double reinforced insulation without conductive parts to a safety conductor (earth).



Classe III: Lampe dont la protection contre les décharges électriques se base sur un système à très basse tension, qui n'est jamais dépassée. Une lampe de Classe III ne doit jamais être fournie avec la mise à terre.

Class III: Luminaire in which protection against electrical shocks is based on the very low safety supply voltage and no voltages are produced higher than this. A Class III luminaire must never be provided with earthing.

Homologations / Homologations



Toutes les lampes produites et présentées dans ce programme ont été réalisées en conformité avec la Norme Européenne EN 60 598 et répondent aux conditions définies par la Directive CEE 73/23 (Directive pour la Basse Tension). Leur fabrication est également conforme à la Directive 89/336 au sujet de la Compatibilité Electromagnétique. Tous les produits faisant partie du champ d'application des Directives ci-dessus mentionnées portent la marque CE, qui atteste de la conformité aux conditions requises.

All lamps manufactured and illustrated in this catalog comply with European Standard EN 60 598 and consequently meet the requirements set forth in Directive 73/23 EEC (Low Voltage Directive). They also comply with Directive 89/336 covering electromagnetic compatibility. All products falling under the scope of the above-mentioned Directives bear the CE mark as proof of their compliance with the respective requirements.



L'apposition de la marque ENEC sur le produit confirme le respect de la Norme Européenne et garantit la fiabilité du système d'organisation et de production responsable de la fabrication du produit par un organisme de certification agréé. La marque ENEC confirme notre engagement et est la meilleure garantie en termes de sécurité et de qualité de tous nos produits.

The ENEC mark on the product stands for the compliance of European Standard as well as a trustworthy organisation and product system and is guaranteed by an accredited certification body. This agreed mark stands for our engagement and represents the best guarantee in security and quality matter of our products.



L'Association espagnole de Normalisation et de Certification AENOR certifie que le Système de garantie de qualité adopté par la société Antares Iluminación S. A. répond aux exigences de la Norme Européenne EN ISO 9001 : Système de Qualité.

The Spanish Association for Standards and Certification AENOR, certifies that quality assurance system adopted by Antares Iluminación, S.A. complies with the requirements of the standard UNE-EN ISO-9001 Quality Systems.

IP 20	Indice de protection contre la pénétration des corps solides et des liquides.	Protection degree offered by the fixture to the ingress of solids and liquids.
IP 20	1er chiffre, protection contre la pénétration de corps solide: 0 Sans protection. 1 Protection contre les corps solides de dimensions supérieures à 50 mm - 2 Protection contre les corps solides de dimensions supérieures à 12 mm - 3 Protection contre les corps solides de dimensions supérieures à 2,5 mm - 4 Protection contre les corps solides de dimensions supérieures à 1 mm - 5 Protection contre les poussières - 6 Totalement protégé contre les poussières.	1st figure, protection against penetration by solid bodies: 0 No protection - 1 Protected against solid bodies over 50 mm in diameter - 2 Protected against solid bodies over 12 mm in diameter - 3 Protected against solid bodies over 2,5 mm in diameter - 4 Protected against solid bodies over 1 mm in diameter - 5 Protected against dust - 6 Fully protected against dust.
IP 20	2ème chiffre, protection contre l'infiltration d'eau: 0 Sans protection. 1 Protection contre les chutes verticales de gouttes d'eau. 2 Protection contre les chutes verticales de gouttes d'eau avec angle d'inclinaison max. de 15°. 3 Protection contre les chutes verticales de gouttes d'eau avec angle d'inclinaison max. de 60°. 4 Protection contre les éclaboussures d'eau. 5 Protection contre les projections d'eau. 6 Protection contre les vagues d'eau. 7 Protection contre l'immersion. 8 Protection contre l'immersion prolongée.	2nd figure, protection against penetration by water: 0 No protection - 1 Protected against drops of water falling vertically - 2 Protected against drops of water at a max. inclination of 15 degrees - 3 Protected against drops of water at a max. inclination of 60 degrees - 4 Protected against splashed of water - 5 Protected against jets of water - 6 Protected against waves - 7 Protected against immersion - 8 Protected against long term immersion.

Pictogramme / Pictography

Conformément à la Réglementation 874/2012/EU, complétant la Directive 2010/30/UE concernant l'étiquetage énergétique des lampes électriques et la compatibilité des appareils d'éclairage avec les différentes sources lumineuses (intégrées ou compatibles), Flos SpA a mis en ligne sur son site internet les étiquettes au format électronique (www.flos.com) dans la rubrique « produits ».

Les modalités pour télécharger les étiquettes dans les différentes langues prévues au niveau communautaire sont les suivantes:

- Choisissez la collection/le produit qui vous intéresse (par ex. <http://www.flos.com/decorative/en/products/floor/Arco>)
- Cliquez sur " Voir fiche technique"
- Cliquez sur "Print Energy Label"
- Sélectionnez la langue et imprimez l'étiquette.

In accordance with the provisions of Regulation 874/2012/EU and integration of the Directive 2010/30/EU concerning labeling indicating the energy consumption of electric lamps and the compatibility of lighting appliances with different light sources (integrated or compatible with these), Flos SpA has inserted the required labels, in electronic form, on its website (www.flos.com) in the area relating to products.

The methods to download the labels in different languages envisaged at Community level are as follows:

- Choose the collection/product you are interested in (for ex: <http://www.flos.com/decorative/en/products/floor/Arco>)
- Click on "see specs sheet"
- Click on "Print Energy Label"
- Select the language and print the label.

Symbols

	<p>Charge statique : Résistance à la charge statique. Conforme à la norme CEI EN 60598-2-13.</p>	<p>Static load: Resistance to static load. In compliance with CEI EN 60598-2-13 standards.</p>		
	<p>Résistance aux charges de couple et de cisaillement. Conforme à la norme CEI EN 60598-2-13.</p>	<p>Drive over Resistance to torque and shear loads. In compliance with CEI EN 60598-2-13 standards.</p>		
	<p>Température du diffuseur conforme à la norme CEI EN 60598-2-13. Vérifier que la température du diffuseur "T max °C" (testé à 25°C) est conforme à votre réglementation locale. Température de la surface du verre <70°C pour la source LED.</p>	<p>Diffuser temperature according to CEI EN 60598-2-13. Check that diffuser's temperature "T max °C" (tested at 25°C) complies with your local regulation. Glass surface temperature <70°C for LED source</p>		
			<p>Conseils pour l'installation de luminaires encastrés : Il est important de prévoir une couche de gravier consistante ou un système de drainage adéquats pour assurer un bon écoulement et éviter la stagnation de l'eau. Le luminaire ne doit pas être installé sur des surfaces creuses.</p>	<p>Advice on installation of recessed luminaires: It is important to provide a consistent gravel layer or drain system to ensure good drainage and to avoid water stagnation. The luminaire must not be installed in hollow surfaces.</p>
			<p>Raccordement électrique : Câblage par entrée de câble, par deux entrées de câble ou par un transformateur d'alimentation installé à distance (à commander séparément).</p>	<p>Electric connection: Wiring through cable input, through two cable inputs or through a feeding transformer installed on remote position (to be ordered separately).</p>
			<p>Le luminaire est équipé de 1 ou 2 entrées de câble.</p>	<p>Luminaire is equipped with 1 or 2 cable input.</p>
			<p>Le luminaire est équipé d'un câble et d'une prise.</p>	<p>Luminaire is equipped with cable and plug.</p>
			<p>Protection contre la pénétration de l'eau par le câble.</p>	<p>Protection against water ingress from the cable</p>
			<p>Installation en surface au mur, au sol ou au plafond.</p>	<p>Surface installation on wall, on ground or on ceiling.</p>
			<p>Installation sur poteau.</p>	<p>Installation on pole.</p>
			<p>Installation au sol (luminaire encastré). Installation suspendue.</p>	<p>In-ground installation (recessed luminaire) Suspended fitting.</p>
			<p>Essai au fil incandescent IEC 60695-2-10 : l'essai au fil incandescent est utilisé pour simuler l'effet de la chaleur qui peut se produire en cas de dysfonctionnement d'un équipement électrique, par exemple en cas de composants surchargés (température spécifiée).</p>	<p>Glow wire test IEC 60695-2-10: the glow wire test is used to simulate the effect of heat as may arise in malfunctioning electrical equipment, such as with overloaded (specified temperature).</p>

Symbols

IK
09

Résistance aux impacts mécaniques externes :
Le code IK se réfère à l'impact externe maximal
que le luminaire est capable de supporter, sans
dommages irréversibles.
Conforme à la norme EN50102.

Resistance to external mechanical impacts:
IK code refers to the maximum external
impact the luminaire is capable to withstand,
without irreversible damage.
In compliance with EN50102 standards.

IK code	Impact Energy (Joule)	Mass/Height
IK00	0,00	-----
IK01	0,15	0,2Kg/70mm
IK02	0,20	0,2Kg/100mm
IK03	0,35	0,2Kg/175mm
IK04	0,50	0,2Kg/250mm
IK05	0,70	0,2Kg/350mm
IK06	1,00	0,5Kg/200mm
IK07	2,00	0,5Kg/400mm
IK08	5,00	1,7Kg/295mm
IK09	10,00	5,0Kg/200mm
IK10	20,00	5,0Kg/400mm

Tecnical Schemes

Schéma électrique et exemple d'installation en série / Wiring Diagram and sample series installation

n.1



Schéma électrique et exemple d'installation en parallèle / Wiring Diagram and sample parallel installation

n.2

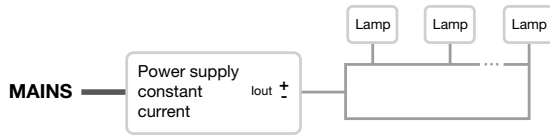

Schéma électrique et exemple d'installation en série à gradation / Wiring Diagram and sample dimmable series installation

n.3

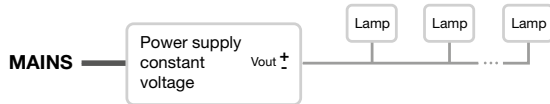

Schéma de câblage et exemple d'installation parallèle à gradation / Wiring Diagram and sample dimmable parallel installation

n.4

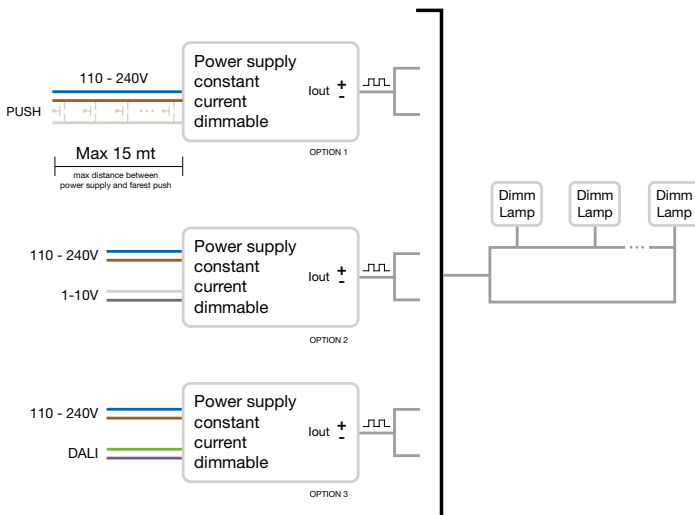
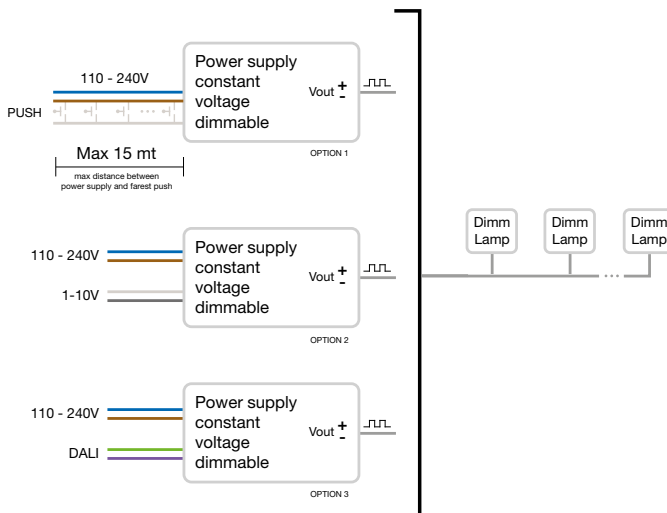

Basic DMX Wiring Scheme

Un système DMX peut inclure un nombre illimité de luminaires à condition de respecter les règles suivantes :

- Utiliser des câbles appropriés pour le bus DMX : paire torsadée blindée avec une impédance constante de 110 Ohm (par exemple Cod.186). L'utilisation de câbles différents ne garantit pas les mêmes performances.
- Tous les 400 m de câble, le signal du bus DMX doit être régénéré avec un Splitter. Cela permet d'étendre l'installation.
- Tous les 20 luminaires, le signal du bus DMX doit être régénéré par un Splitter. Cela permet d'étendre l'installation.
- Tous les luminaires doivent être connectés en série au bus DMX. Aucune connexion en étoile n'est autorisée. Il faut prendre en compte que l'utilisation d'un splitter peut résoudre le problème d'avoir une entrée du bus et plusieurs sorties du bus.
- Chaque câble doit avoir une résistance de terminaison de 120 Ohm.

A DMX system can include an unlimited number of fixtures on condition that the following rules are respected:

- Use suitable cables for DMX bus: shielded twisted pair with 110 Ohm constant impedance (e.g. Cod.186). The use of different cables doesn't assure the same performance.
- Every 400mt of cable the DMX bus signal needs to be regenerated with a Splitter. This allows to extend the installation.
- Every 20 fixtures the DMX bus signal needs to be regenerated with a Splitter. This allows to extend the installation.
- All fixtures have to be connected in series to the DMX bus. No star connection allowed. It has to be taken into account that the use of a splitter can solve the problem having one bus input and more bus output.
- Each cable must have a 120 Ohm termination resistor.

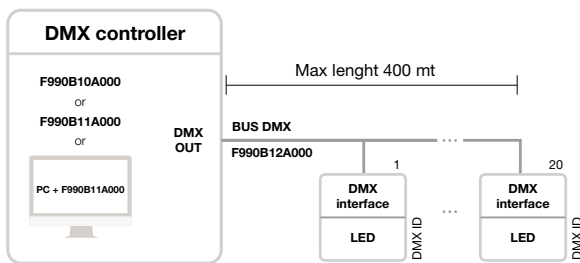

Extended DMX Wiring Pattern

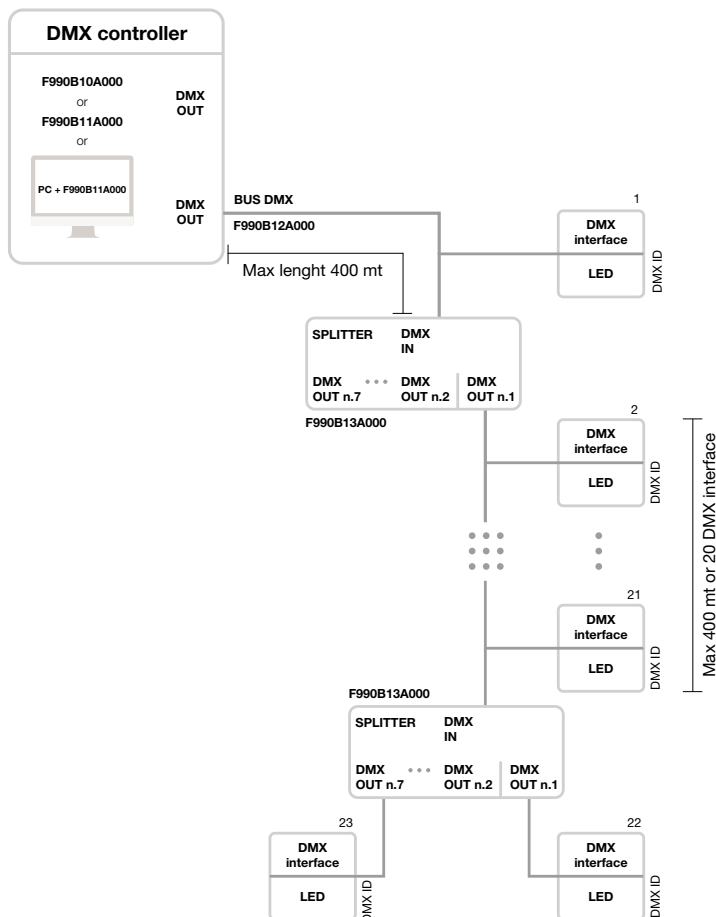

Technical Schemes

Schéma de câblage et exemple d'installation / Wiring Diagram and sample installation.

n.5



Schéma de câblage et exemple d'installation / Wiring Diagram and sample installation.

n.6

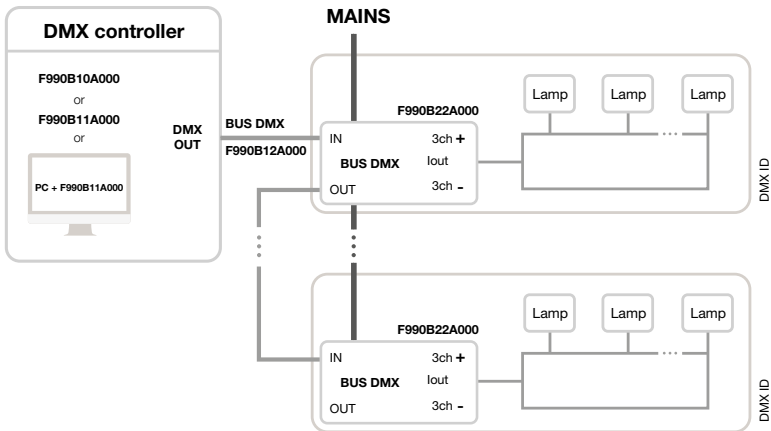
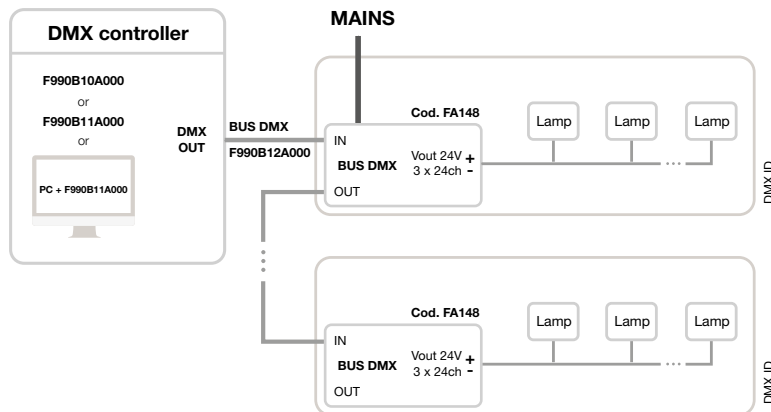

Technical Schemes

Schéma de câblage et exemple d'installation / Wiring Diagram and sample installation.

n.7



Schéma de câblage et exemple d'installation / Wiring Diagram and sample installation.

n.8

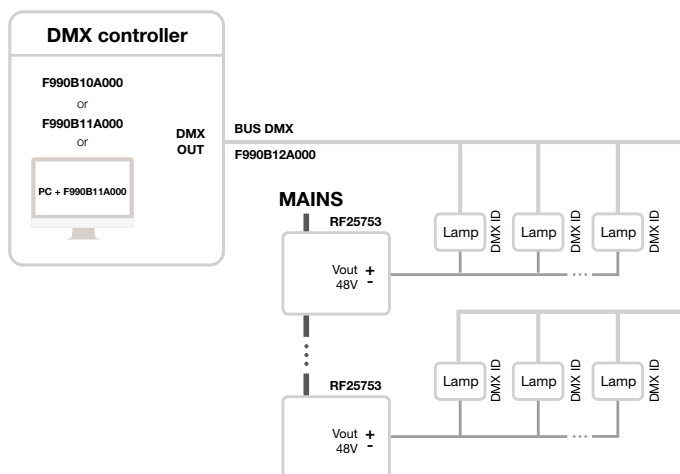
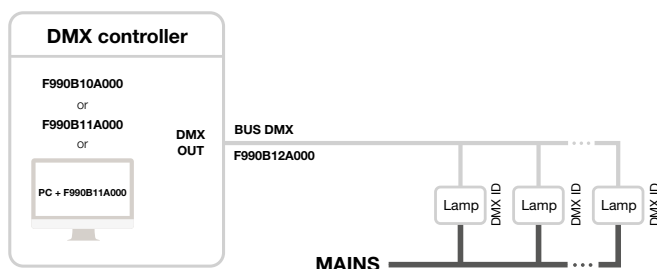

Attention

Le câblage des luminaires à LED fonctionne en courant constant et connecté en série (schémas 1, 3 et 5) : Ne jamais connecter le luminaire à une source d'alimentation allumée.

Toujours connecter les luminaires à la source d'alimentation, et seulement après avoir connecté la source d'alimentation au secteur.

Schémas de connexion : Les luminaires en courant constant doivent toujours être connectés en série ; les luminaires en tension constante doivent toujours être connectés en parallèle.

Respectez toujours la polarité en fonction du système à courant continu.

Les sources d'alimentation doivent toujours correspondre aux caractéristiques de l'installation : Ne jamais utiliser une source d'alimentation en courant constant sur un luminaire en tension constante et vice versa.

Le choix de la source d'alimentation doit tenir compte de la consommation réelle du luminaire (données indiquées dans le catalogue) avec une augmentation de 20% pour faire face à toute perte potentielle sur l'installation.

Les luminaires à LED et les sources d'alimentation sont protégés contre les interférences sur la ligne. Il est néanmoins fortement recommandé d'établir des lignes d'alimentation dédiées pour éviter toute interférence potentielle soudaine et sévère (charges inductives comme les pompes ou les lampes à décharge) qui sont susceptibles d'endommager le module LED.

Attention

Wiring of LED luminaires run in constant current and connected in series (schemes 1,3 and 5): Never connect the luminaire to a switched on power supply.

Always connect luminaires to the power supply, and only after connect the power supply to the mains.

Connection schemes: Luminaires in constant current must always be connected in series; luminaires in constant tension must always be connected in parallel.

Always respect polarity according to the DC system.

Power Supplies must always match installation features: Never use a constant current power supply on a constant tension luminaire and vice versa.

The choice of the power supply must take into account the real power consumption of the luminaire (data shown in the catalogue) with a 20% increase to face any potential loss on the installation.

LED Luminaires and power supplies are protected against interferences on the line, it is anyway highly recommended to set dedicated feeding lines to avoid any potential sudden and severe interference (inductive loads like pumps or discharge lamps) that are likely to damage the LED module.

Alphabetical Index

A-Rise	480	Kirk	710
A-Round	470	Klein Pro	360
Aimer	730	Landlord	292
Bellhop	310	Leila	698
Belvedere	348	Lighting In The Rain	285
C-Me	526	Mayday	198
Camouflage	416	Mile	206
Casting	322	My Way	408
Caule	258	Outgraze	604
Captain Flint	240	Perseo	786
Climber	426	Platter	686
Dooku	810	Pointbreak	156
Eclipse	666	Real Matter	398
Fenestra	462	Spine	16
Flauta	274	Spock	718
Franco	764	Talia	388
Gobi	504	Tau	654
Heavy Metal	440	Walkstick	334
Hyperion	676	Zefiro	370
I - Ron	380		
IC_Light	250		
In Vitro	186		
Ingraze	542		

Garantie

ARES s.r.l. garantit à l'Acheteur le bon fonctionnement de ses produits pendant une période de deux ans à compter de la date d'achat de l'Acheteur (la date de la facture).

Pendant la période de garantie, tout défaut des produits ARES s.r.l. résultant d'un vice de matériau ou de fabrication sera rectifié gratuitement.

ARES s.r.l. se réserve le droit de corriger le défaut par réparation, échange ou remplacement.

Le fabricant ne saura être tenu responsable des éléments suivants, et la garantie ne les couvre pas:

Pièces et matériaux soumis à une usure continue ;
Problèmes résultant de causes externes telles que des accidents, abus, mauvaises utilisations, mauvaises manipulations, négligences, émeutes, explosions, catastrophes naturelles, incendie, vol, vandalisme ou d'autres causes externes sans rapport avec le défaut du produit ;
Conditions démontrant une installation défectueuse, une mauvaise application, des conditions environnementales extrêmes au-delà de celles définies dans les spécifications du produit, des situations de sous/surtension, un manque de conformité aux instructions applicables, une manipulation, expédition ou maintenance inadéquates ou inappropriées, une négligence, une altération ou un accident ;
Incompatibilité, conception, fabrication, installation, fonctionnement ou entretien inappropriés de produits non fournis par le fabricant ;
Situations dans lesquelles les appareils de contrôle du fabricant ou toute autre pièce sont remplacés par ceux d'autres fabricants ;
La qualité de l'installation des produits du fabricant par l'installateur de ces produits. Par exemple, les garanties ci-dessus ne couvriraient pas les problèmes résultant des méthodes d'installation d'un tel installateur.
Petits défauts ayant un effet négligeable sur la valeur ou le fonctionnement.

La garantie ne s'applique pas à d'autres réclamations (par exemple, les coûts supplémentaires encourus par le client), à moins que le fabricant n'en convienne et ne les accepte par écrit.

Warranty

ARES s.r.l. warrants to the Buyer the satisfactory operation of its products for the period of two years from date of Purchaser's purchase (the invoice date).

Within the warranty period any defects with ARES s.r.l. products as a result of faulty materials or workmanship will be rectified free of charge.

ARES s.r.l. reserves the right to rectify the fault by repair, exchange or replacement.

The warranty does not cover and the manufacturer will not be liable for:

Parts and materials subject to continuous wear;
Problems resulting from external causes such as accident, abuse, misuse, mishandling, negligence, fire, theft, vandalism, riot, explosion, natural disaster, or other external causes unrelated to product defect;
Conditions demonstrating faulty installation, misapplication, extreme environmental conditions beyond those defined in the product specification, under/over voltage situations, lack of compliance with applicable instructions, improper or inadequate handling, shipping, maintenance, negligence, accident, or tampering;
Incompatibility, improper design, manufacture, installation, operation or maintenance of products not supplied by Manufacturer;
Situations in which manufacturer's control gears fixtures and or any parts are replaced with those from other manufacturers;
The quality of the installation on Manufacturer products by the installer of those products. For example, the above warranties would not cover problems resulting from such an installer's installation methods.
Small defects having a negligible effect in value or operation.

The warranty does not apply to any other claims (for instance additional cost incurred by the customer) unless agreed and accepted by the manufacturer in writing.

Page	Reference	Page	Reference	Page	Reference	Page	Reference	Page	Reference
354	F001A21A001	354	F001B21B001	355	F001C23A001.A	356	F001D22B001.A	356	F001D41B001
354	F001A21A006	354	F001B21B006	355	F001C23A006.A	356	F001D22B006.A	356	F001D41B006
354	F001A21A012	354	F001B21B012	355	F001C23A012.A	356	F001D22B012.A	356	F001D41B012
354	F001A21A018	354	F001B21B018	355	F001C23A018.A	356	F001D22B018.A	356	F001D41B018
354	F001A21A030	354	F001B21B030	355	F001C23A030.A	356	F001D22B030.A	356	F001D41B030
354	F001A21A033	354	F001B21B033	355	F001C23A033.A	356	F001D22B033.A	356	F001D41B033
354	F001A21B001	354	F001B21D001	355	F001C31A001.A	356	F001D23A001.A	356	F001D42A001
354	F001A21B006	354	F001B21D006	355	F001C31A006.A	356	F001D23A006.A	356	F001D42A006
354	F001A21B012	354	F001B21D012	355	F001C31A012.A	356	F001D23A012.A	356	F001D42A012
354	F001A21B018	354	F001B21D018	355	F001C31A018.A	356	F001D23A018.A	356	F001D42A018
354	F001A21B030	354	F001B21D030	355	F001C31A030.A	356	F001D23A030.A	356	F001D42A030
354	F001A21B033	354	F001B21D033	355	F001C31A033.A	356	F001D23A033.A	356	F001D42A033
354	F001A21D001	354	F001B31A001	355	F001C32A001.A	356	F001D23B001.A	356	F001D42B001
354	F001A21D006	354	F001B31A006	355	F001C32A006.A	356	F001D23B006.A	356	F001D42B006
354	F001A21D012	354	F001B31A012	355	F001C32A012.A	356	F001D23B012.A	356	F001D42B012
354	F001A21D018	354	F001B31A018	355	F001C32A018.A	356	F001D23B018.A	356	F001D42B018
354	F001A21D030	354	F001B31A030	355	F001C32A030.A	356	F001D23B030.A	356	F001D42B030
354	F001A21D033	354	F001B31A033	355	F001C32A033.A	356	F001D23B033.A	356	F001D42B033
354	F001A31A001	354	F001B31B001	355	F001C33A001.A	356	F001D31A001.A	356	F001D43A001
354	F001A31A006	354	F001B31B006	355	F001C33A006.A	356	F001D31A006.A	356	F001D43A006
354	F001A31A012	354	F001B31B012	355	F001C33A012.A	356	F001D31A012.A	356	F001D43A012
354	F001A31A018	354	F001B31B018	355	F001C33A018.A	356	F001D31A018.A	356	F001D43A018
354	F001A31A030	354	F001B31B030	355	F001C33A030.A	356	F001D31A030.A	356	F001D43A030
354	F001A31A033	354	F001B31B033	355	F001C33A033.A	356	F001D31A033.A	356	F001D43A033
354	F001A31B001	354	F001B31D001	355	F001C41A001	356	F001D31B001.A	356	F001D43B001
354	F001A31B006	354	F001B31D006	355	F001C41A006	356	F001D31B006.A	356	F001D43B006
354	F001A31B012	354	F001B31D012	355	F001C41A012	356	F001D31B012.A	356	F001D43B012
354	F001A31B018	354	F001B31D018	355	F001C41A018	356	F001D31B018.A	356	F001D43B018
354	F001A31B030	354	F001B31D030	355	F001C41A030	356	F001D31B030.A	356	F001D43B030
354	F001A31B033	354	F001B31D033	355	F001C41A033	356	F001D31B033.A	356	F001D43B033
354	F001A31D001	354	F001B41A001	355	F001C42A001	356	F001D32A001.A	357	F001E21A001.A
354	F001A31D006	354	F001B41A006	355	F001C42A006	356	F001D32A006.A	357	F001E21A006.A
354	F001A31D012	354	F001B41A012	355	F001C42A012	356	F001D32A012.A	357	F001E21A012.A
354	F001A31D018	354	F001B41A018	355	F001C42A018	356	F001D32A018.A	357	F001E21A018.A
354	F001A31D030	354	F001B41A030	355	F001C42A030	356	F001D32A030.A	357	F001E21A030.A
354	F001A31D033	354	F001B41A033	355	F001C42A033	356	F001D32A033.A	357	F001E21A033.A
354	F001A41A001	354	F001B41B001	355	F001C43A001	356	F001D32B001.A	357	F001E21B001.A
354	F001A41A006	354	F001B41B006	355	F001C43A006	356	F001D32B006.A	357	F001E21B006.A
354	F001A41A012	354	F001B41B012	355	F001C43A012	356	F001D32B012.A	357	F001E21B012.A
354	F001A41A018	354	F001B41B018	355	F001C43A018	356	F001D32B018.A	357	F001E21B018.A
354	F001A41A030	354	F001B41B030	355	F001C43A030	356	F001D32B030.A	357	F001E21B030.A
354	F001A41A033	354	F001B41B033	355	F001C43A033	356	F001D32B033.A	357	F001E21B033.A
354	F001A41B001	354	F001B41D001	356	F001D21A001.A	356	F001D33A001.A	357	F001E21D001.A
354	F001A41B006	354	F001B41D006	356	F001D21A006.A	356	F001D33A006.A	357	F001E21D006.A
354	F001A41B012	354	F001B41D012	356	F001D21A012.A	356	F001D33A012.A	357	F001E21D012.A
354	F001A41B018	354	F001B41D018	356	F001D21A018.A	356	F001D33A018.A	357	F001E21D018.A
354	F001A41B030	354	F001B41D030	356	F001D21A030.A	356	F001D33A030.A	357	F001E21D030.A
354	F001A41B033	354	F001B41D033	356	F001D21A033.A	356	F001D33A033.A	357	F001E21D033.A
354	F001A41D001	355	F001C21A001.A	356	F001D21B001.A	356	F001D33B001.A	357	F001E22A001.A
354	F001A41D006	355	F001C21A006.A	356	F001D21B006.A	356	F001D33B006.A	357	F001E22A006.A
354	F001A41D012	355	F001C21A012.A	356	F001D21B012.A	356	F001D33B012.A	357	F001E22A012.A
354	F001A41D018	355	F001C21A018.A	356	F001D21B018.A	356	F001D33B018.A	357	F001E22A018.A
354	F001A41D030	355	F001C21A030.A	356	F001D21B030.A	356	F001D33B030.A	357	F001E22A030.A
354	F001A41D033	355	F001C21A033.A	356	F001D21B033.A	356	F001D33B033.A	357	F001E22A033.A
354	F001B21A001	355	F001C22A001.A	356	F001D22A001.A	356	F001D41A001	357	F001E22B001.A
354	F001B21A006	355	F001C22A006.A	356	F001D22A006.A	356	F001D41A006	357	F001E22B006.A
354	F001B21A012	355	F001C22A012.A	356	F001D22A012.A	356	F001D41A012	357	F001E22B012.A
354	F001B21A018	355	F001C22A018.A	356	F001D22A018.A	356	F001D41A018	357	F001E22B018.A
354	F001B21A030	355	F001C22A030.A	356	F001D22A030.A	356	F001D41A030	357	F001E22B030.A
354	F001B21A033	355	F001C22A033.A	356	F001D22A033.A	356	F001D41A033	357	F001E22B033.A

Page	Reference	Page	Reference	Page	Reference	Page	Reference	Page	Reference
357	F001E22D001.A	357	F001E33A001	357	F001E43B001	358	F001F43A001	359	F001Z010000
357	F001E22D006.A	357	F001E33A006	357	F001E43B006	358	F001F43A006	347	F001Z020000
357	F001E22D012.A	357	F001E33A012	357	F001E43B012	358	F001F43A012	359	F001Z030000
357	F001E22D018.A	357	F001E33A018	357	F001E43B018	358	F001F43A018	359	F001Z040000
357	F001E22D030.A	357	F001E33A030	357	F001E43B030	358	F001F43A030	366	F002A20A001.B
357	F001E22D033.A	357	F001E33A033	357	F001E43B033	358	F001F43A033	366	F002A20A006.B
357	F001E23A001.A	357	F001E33B001	357	F001E43D001	359	F001G21A001.A	366	F002A20A012.B
357	F001E23A006.A	357	F001E33B006	357	F001E43D006	359	F001G21A006.A	366	F002A20A018.B
357	F001E23A012.A	357	F001E33B012	357	F001E43D012	359	F001G21A012.A	366	F002A20A030.B
357	F001E23A018.A	357	F001E33B018	357	F001E43D018	359	F001G21A018.A	366	F002A20A033.B
357	F001E23A030.A	357	F001E33B030	357	F001E43D030	359	F001G21A030.A	366	F002A20B001.B
357	F001E23A033.A	357	F001E33B033	357	F001E43D033	359	F001G21A033.A	366	F002A20B006.B
357	F001E23B001.A	357	F001E33D001	358	F001F21A001.A	359	F001G22A001.A	366	F002A20B012.B
357	F001E23B006.A	357	F001E33D006	358	F001F21A006.A	359	F001G22A006.A	366	F002A20B018.B
357	F001E23B012.A	357	F001E33D012	358	F001F21A012.A	359	F001G22A012.A	366	F002A20B030.B
357	F001E23B018.A	357	F001E33D018	358	F001F21A018.A	359	F001G22A018.A	366	F002A20B033.B
357	F001E23B030.A	357	F001E33D030	358	F001F21A030.A	359	F001G22A030.A	366	F002A20D001.B
357	F001E23B033.A	357	F001E33D033	358	F001F21A033.A	359	F001G22A033.A	366	F002A20D006.B
357	F001E23D001.A	357	F001E41A001	358	F001F22A001.A	359	F001G23A001.A	366	F002A20D012.B
357	F001E23D006.A	357	F001E41A006	358	F001F22A006.A	359	F001G23A006.A	366	F002A20D018.B
357	F001E23D012.A	357	F001E41A012	358	F001F22A012.A	359	F001G23A012.A	366	F002A20D030.B
357	F001E23D018.A	357	F001E41A018	358	F001F22A018.A	359	F001G23A018.A	366	F002A20D033.B
357	F001E23D030.A	357	F001E41A030	358	F001F22A030.A	359	F001G23A030.A	366	F002A21A070.B
357	F001E23D033.A	357	F001E41A033	358	F001F22A033.A	359	F001G23A033.A	366	F002A21A071.B
357	F001E31A001.A	357	F001E41B001	358	F001F23A001.A	359	F001G31A001.A	366	F002A21B070.B
357	F001E31A006.A	357	F001E41B006	358	F001F23A006.A	359	F001G31A006.A	366	F002A21B071.B
357	F001E31A012.A	357	F001E41B012	358	F001F23A012.A	359	F001G31A012.A	366	F002A21D070.B
357	F001E31A018.A	357	F001E41B018	358	F001F23A018.A	359	F001G31A018.A	366	F002A21D071.B
357	F001E31A030.A	357	F001E41B030	358	F001F23A030.A	359	F001G31A030.A	366	F002A30A001.B
357	F001E31A033.A	357	F001E41B033	358	F001F23A033.A	359	F001G31A033.A	366	F002A30A006.B
357	F001E31B001.A	357	F001E41D001	358	F001F31A001.A	359	F001G32A001.A	366	F002A30A012.B
357	F001E31B006.A	357	F001E41D006	358	F001F31A006.A	359	F001G32A006.A	366	F002A30A018.B
357	F001E31B012.A	357	F001E41D012	358	F001F31A012.A	359	F001G32A012.A	366	F002A30A030.B
357	F001E31B018.A	357	F001E41D018	358	F001F31A018.A	359	F001G32A018.A	366	F002A30A033.B
357	F001E31B030.A	357	F001E41D030	358	F001F31A030.A	359	F001G32A030.A	366	F002A30B001.B
357	F001E31B033.A	357	F001E41D033	358	F001F31A033.A	359	F001G32A033.A	366	F002A30B006.B
357	F001E31D001.A	357	F001E42A001	358	F001F32A001.A	359	F001G33A001.A	366	F002A30B012.B
357	F001E31D006.A	357	F001E42A006	358	F001F32A006.A	359	F001G33A006.A	366	F002A30B018.B
357	F001E31D012.A	357	F001E42A012	358	F001F32A012.A	359	F001G33A012.A	366	F002A30B030.B
357	F001E31D018.A	357	F001E42A018	358	F001F32A018.A	359	F001G33A018.A	366	F002A30B033.B
357	F001E31D030.A	357	F001E42A030	358	F001F32A030.A	359	F001G33A030.A	366	F002A30D001.B
357	F001E31D033.A	357	F001E42A033	358	F001F32A033.A	359	F001G33A033.A	366	F002A30D006.B
357	F001E32A001.A	357	F001E42B001	358	F001F33A001.A	359	F001G41A001	366	F002A30D012.B
357	F001E32A006.A	357	F001E42B006	358	F001F33A006.A	359	F001G41A006	366	F002A30D018.B
357	F001E32A012.A	357	F001E42B012	358	F001F33A012.A	359	F001G41A012	366	F002A30D030.B
357	F001E32A018.A	357	F001E42B018	358	F001F33A018.A	359	F001G41A018	366	F002A30D033.B
357	F001E32A030.A	357	F001E42B030	358	F001F33A030.A	359	F001G41A030	366	F002A31A070.B
357	F001E32A033.A	357	F001E42B033	358	F001F33A033.A	359	F001G41A033	366	F002A31A071.B
357	F001E32B001.A	357	F001E42D001	358	F001F41A001	359	F001G42A001	366	F002A31B070.B
357	F001E32B006.A	357	F001E42D006	358	F001F41A006	359	F001G42A006	366	F002A31B071.B
357	F001E32B012.A	357	F001E42D012	358	F001F41A012	359	F001G42A012	366	F002A31D070.B
357	F001E32B018.A	357	F001E42D018	358	F001F41A018	359	F001G42A018	366	F002A31D071.B
357	F001E32B030.A	357	F001E42D030	358	F001F41A030	359	F001G42A030	366	F002A40A001.B
357	F001E32B033.A	357	F001E42D033	358	F001F41A033	359	F001G42A033	366	F002A40A006.B
357	F001E32D001.A	357	F001E43A001	358	F001F42A001	359	F001G43A001	366	F002A40A012.B
357	F001E32D006.A	357	F001E43A006	358	F001F42A006	359	F001G43A006	366	F002A40A018.B
357	F001E32D012.A	357	F001E43A012	358	F001F42A012	359	F001G43A012	366	F002A40A030.B
357	F001E32D018.A	357	F001E43A018	358	F001F42A018	359	F001G43A018	366	F002A40A033.B
357	F001E32D030.A	357	F001E43A030	358	F001F42A030	359	F001G43A030	366	F002A40B001.B
357	F001E32D033.A	357	F001E43A033	358	F001F42A033	359	F001G43A033	366	F002A40B006.B

Page	Reference	Page	Reference	Page	Reference	Page	Reference	Page	Reference
366	F002A40B012.B	367	F002B31B070.B	317	F003A21D030	318	F003B21D006	316	F003C21B033
366	F002A40B018.B	367	F002B31B071.B	317	F003A21D033	318	F003B21D012	316	F003C21B056
366	F002A40B030.B	367	F002B31D070.B	317	F003A21D056	318	F003B21D018	316	F003C21D001
366	F002A40B033.B	367	F002B31D071.B	317	F003A31A001	318	F003B21D030	316	F003C21D006
366	F002A40D001.B	367	F002B40A001.B	317	F003A31A006	318	F003B21D033	316	F003C21D012
366	F002A40D006.B	367	F002B40A006.B	317	F003A31A012	318	F003B21D056	316	F003C21D018
366	F002A40D012.B	367	F002B40A012.B	317	F003A31A018	318	F003B31A001	316	F003C21D030
366	F002A40D018.B	367	F002B40A018.B	317	F003A31A030	318	F003B31A006	316	F003C21D033
366	F002A40D030.B	367	F002B40A030.B	317	F003A31A033	318	F003B31A012	316	F003C21D056
366	F002A40D033.B	367	F002B40A033.B	317	F003A31A056	318	F003B31A018	316	F003C31A001
366	F002A41A070.B	367	F002B40B001.B	317	F003A31B001	318	F003B31A030	316	F003C31A006
366	F002A41A071.B	367	F002B40B006.B	317	F003A31B006	318	F003B31A033	316	F003C31A012
366	F002A41B070.B	367	F002B40B012.B	317	F003A31B012	318	F003B31A056	316	F003C31A018
366	F002A41B071.B	367	F002B40B018.B	317	F003A31B018	318	F003B31B001	316	F003C31A030
366	F002A41D070.B	367	F002B40B030.B	317	F003A31B030	318	F003B31B006	316	F003C31A033
366	F002A41D071.B	367	F002B40B033.B	317	F003A31B033	318	F003B31B012	316	F003C31A056
367	F002B20A001.B	367	F002B40D001.B	317	F003A31B056	318	F003B31B018	316	F003C31B001
367	F002B20A006.B	367	F002B40D006.B	317	F003A31D001	318	F003B31B030	316	F003C31B006
367	F002B20A012.B	367	F002B40D012.B	317	F003A31D006	318	F003B31B033	316	F003C31B012
367	F002B20A018.B	367	F002B40D018.B	317	F003A31D012	318	F003B31B056	316	F003C31B018
367	F002B20A030.B	367	F002B40D030.B	317	F003A31D018	318	F003B31D001	316	F003C31B030
367	F002B20A033.B	367	F002B40D033.B	317	F003A31D030	318	F003B31D006	316	F003C31B033
367	F002B20B001.B	367	F002B41A070.B	317	F003A31D033	318	F003B31D012	316	F003C31B056
367	F002B20B006.B	367	F002B41A071.B	317	F003A31D056	318	F003B31D018	316	F003C31D001
367	F002B20B012.B	367	F002B41B070.B	317	F003A41A001	318	F003B31D030	316	F003C31D006
367	F002B20B018.B	367	F002B41B071.B	317	F003A41A006	318	F003B31D033	316	F003C31D012
367	F002B20B030.B	367	F002B41D070.B	317	F003A41A012	318	F003B31D056	316	F003C31D018
367	F002B20B033.B	367	F002B41D071.B	317	F003A41A018	318	F003B41A001	316	F003C31D030
367	F002B20D001.B	368	F002Z010001.A	317	F003A41A030	318	F003B41A006	316	F003C31D033
367	F002B20D006.B	368	F002Z010006.A	317	F003A41A033	318	F003B41A012	316	F003C31D056
367	F002B20D012.B	368	F002Z010012.A	317	F003A41A056	318	F003B41A018	316	F003C41A001
367	F002B20D018.B	368	F002Z010018.A	317	F003A41B001	318	F003B41A030	316	F003C41A006
367	F002B20D030.B	368	F002Z010030.A	317	F003A41B006	318	F003B41A033	316	F003C41A012
367	F002B20D033.B	368	F002Z010033.A	317	F003A41B012	318	F003B41A056	316	F003C41A018
367	F002B21A070.B	368	F002Z020000	317	F003A41B018	318	F003B41B001	316	F003C41A030
367	F002B21A071.B	368	F002Z030000.A	317	F003A41B030	318	F003B41B006	316	F003C41A033
367	F002B21B070.B	368	F002Z040070	317	F003A41B033	318	F003B41B012	316	F003C41A056
367	F002B21B071.B	368	F002Z040071	317	F003A41B056	318	F003B41B018	316	F003C41B001
367	F002B21D070.B	368	F002Z040073	317	F003A41D001	318	F003B41B030	316	F003C41B006
367	F002B21D071.B	368	F002Z050070	317	F003A41D006	318	F003B41B033	316	F003C41B012
367	F002B30A001.B	368	F002Z050071	317	F003A41D012	318	F003B41B056	316	F003C41B018
367	F002B30A006.B	368	F002Z050073	317	F003A41D018	318	F003B41D001	316	F003C41B030
367	F002B30A012.B	317	F003A21A001	317	F003A41D030	318	F003B41D006	316	F003C41B033
367	F002B30A018.B	317	F003A21A006	317	F003A41D033	318	F003B41D012	316	F003C41B056
367	F002B30A030.B	317	F003A21A012	317	F003A41D056	318	F003B41D018	316	F003C41D001
367	F002B30A033.B	317	F003A21A018	318	F003B21A001	318	F003B41D030	316	F003C41D006
367	F002B30B001.B	317	F003A21A030	318	F003B21A006	318	F003B41D033	316	F003C41D012
367	F002B30B006.B	317	F003A21A033	318	F003B21A012	318	F003B41D056	316	F003C41D018
367	F002B30B012.B	317	F003A21A056	318	F003B21A018	316	F003C21A001	316	F003C41D030
367	F002B30B018.B	317	F003A21B001	318	F003B21A030	316	F003C21A006	316	F003C41D033
367	F002B30B030.B	317	F003A21B006	318	F003B21A033	316	F003C21A012	316	F003C41D056
367	F002B30B033.B	317	F003A21B012	318	F003B21A056	316	F003C21A018	320	F003G21A006
367	F002B30D001.B	317	F003A21B018	318	F003B21B001	316	F003C21A030	320	F003G21A018
367	F002B30D006.B	317	F003A21B030	318	F003B21B006	316	F003C21A033	320	F003G21A033
367	F002B30D012.B	317	F003A21B033	318	F003B21B012	316	F003C21A056	320	F003G21B006
367	F002B30D018.B	317	F003A21B056	318	F003B21B018	316	F003C21B001	320	F003G21B018
367	F002B30D030.B	317	F003A21D001	318	F003B21B030	316	F003C21B006	320	F003G21B033
367	F002B30D033.B	317	F003A21D006	318	F003B21B033	316	F003C21B012	320	F003G21D006
367	F002B31A070.B	317	F003A21D012	318	F003B21B056	316	F003C21B018	320	F003G21D018
367	F002B31A071.B	317	F003A21D018	318	F003B21D001	316	F003C21B030	320	F003G21D033

Page	Reference	Page	Reference	Page	Reference	Page	Reference	Page	Reference
320	F003G31A006	320	F003K31D006	305	F004A35A056	301	F004C30A012	299	F004E31A012
320	F003G31A018	320	F003K31D018	305	F004A35H056	301	F004C30A018	299	F004E31A018
320	F003G31A033	320	F003K31D033	304	F004A36A05601	301	F004C30A030	299	F004E31A030
320	F003G31B006	320	F003K41A006	304	F004A37A05602	301	F004C30A033	299	F004E31A033
320	F003G31B018	320	F003K41A018	304	F004A41A056	301	F004C40A001	299	F004E32A001.A
320	F003G31B033	320	F003K41A033	304	F004A41H056	301	F004C40A006	299	F004E32A006.A
320	F003G31D006	320	F003K41B006	304	F004A42A056	301	F004C40A012	299	F004E32A012.A
320	F003G31D018	320	F003K41B018	304	F004A42H056	301	F004C40A018	299	F004E32A018.A
320	F003G31D033	320	F003K41B033	304	F004A43A056	301	F004C40A030	299	F004E32A030.A
320	F003G41A006	320	F003K41D006	304	F004A43H056	301	F004C40A033	299	F004E32A033.A
320	F003G41A018	320	F003K41D018	305	F004A44A056	298	F004D21A001	299	F004E41A001
320	F003G41A033	320	F003K41D033	305	F004A44H056	298	F004D21A006	299	F004E41A006
320	F003G41B006	319	F003L21A006	305	F004A45A056	298	F004D21A012	299	F004E41A012
320	F003G41B018	319	F003L21A018	305	F004A45H056	298	F004D21A018	299	F004E41A018
320	F003G41B033	319	F003L21A033	304	F004A46A05601	298	F004D21A030	299	F004E41A030
320	F003G41D006	319	F003L21B006	304	F004A47A05602	298	F004D21A033	299	F004E41A033
320	F003G41D018	319	F003L21B018	306	F004B21A056	298	F004D22A001	299	F004E42A001
320	F003G41D033	319	F003L21B033	306	F004B21H056	298	F004D22A006	299	F004E42A006
319	F003H21A006	319	F003L21D006	306	F004B22A056	298	F004D22A012	299	F004E42A012
319	F003H21A018	319	F003L21D018	306	F004B22H056	298	F004D22A018	299	F004E42A018
319	F003H21A033	319	F003L21D033	306	F004B23A056	298	F004D22A030	299	F004E42A030
319	F003H21B006	319	F003L31A006	306	F004B23H056	298	F004D22A033	299	F004E42A033
319	F003H21B018	319	F003L31A018	307	F004B24A056	298	F004D31A001	298	F004F21A071
319	F003H21B033	319	F003L31A033	307	F004B24H056	298	F004D31A006	298	F004F22A071
319	F003H21D006	319	F003L31B006	307	F004B25A056	298	F004D31A012	298	F004F31A071
319	F003H21D018	319	F003L31B018	307	F004B25H056	298	F004D31A018	298	F004F32A071
319	F003H21D033	319	F003L31B033	306	F004B26A05601	298	F004D31A030	298	F004F41A071
319	F003H31A006	319	F003L31D006	306	F004B27A05602	298	F004D31A033	298	F004F42A071
319	F003H31A018	319	F003L31D018	306	F004B31A056	298	F004D32A001	299	F004G21A071
319	F003H31A033	319	F003L31D033	306	F004B31H056	298	F004D32A006	299	F004G22A071.A
319	F003H31B006	319	F003L41A006	306	F004B32A056	298	F004D32A012	299	F004G31A071
319	F003H31B018	319	F003L41A018	306	F004B32H056	298	F004D32A018	299	F004G32A071.A
319	F003H31B033	319	F003L41A033	306	F004B33A056	298	F004D32A030	299	F004G41A071
319	F003H31D006	319	F003L41B006	306	F004B33H056	298	F004D32A033	299	F004G42A071
319	F003H31D018	319	F003L41B018	307	F004B34A056	298	F004D41A001	301	F004H20A071
319	F003H31D033	319	F003L41B033	307	F004B34H056	298	F004D41A006	301	F004H30A071
319	F003H41A006	319	F003L41D006	307	F004B35A056	298	F004D41A012	301	F004H40A071
319	F003H41A018	319	F003L41D018	307	F004B35H056	298	F004D41A018	300	F004Z010001
319	F003H41A033	319	F003L41D033	306	F004B36A05601	298	F004D41A030	300	F004Z010006
319	F003H41B006	318	F003Z010000	306	F004B37A05602	298	F004D41A033	300	F004Z010012
319	F003H41B018	304	F004A21A056	306	F004B41A056	298	F004D42A001	300	F004Z010018
319	F003H41B033	304	F004A21H056	306	F004B41H056	298	F004D42A006	300	F004Z010030
319	F003H41D006	304	F004A22A056	306	F004B42A056	298	F004D42A012	300	F004Z010033
319	F003H41D018	304	F004A22H056	306	F004B42H056	298	F004D42A018	300	F004Z020001
319	F003H41D033	304	F004A23A056	306	F004B43A056	298	F004D42A030	300	F004Z020006
320	F003K21A006	304	F004A23H056	306	F004B43H056	298	F004D42A033	300	F004Z020012
320	F003K21A018	305	F004A24A056	307	F004B44A056	299	F004E21A001	300	F004Z020018
320	F003K21A033	305	F004A24H056	307	F004B44H056	299	F004E21A006	300	F004Z020030
320	F003K21B006	305	F004A25A056	307	F004B45A056	299	F004E21A012	300	F004Z020033
320	F003K21B018	305	F004A25H056	307	F004B45H056	299	F004E21A018	300	F004Z030001
320	F003K21B033	304	F004A26A05601	306	F004B46A05601	299	F004E21A030	300	F004Z030006
320	F003K21D006	304	F004A27A05602	306	F004B47A05602	299	F004E21A033	300	F004Z030012
320	F003K21D018	304	F004A31A056	301	F004C20A001	299	F004E22A001.A	300	F004Z030018
320	F003K21D033	304	F004A31H056	301	F004C20A006	299	F004E22A006.A	300	F004Z030030
320	F003K31A006	304	F004A32A056	301	F004C20A012	299	F004E22A012.A	300	F004Z030033
320	F003K31A018	304	F004A32H056	301	F004C20A018	299	F004E22A018.A	300	F004Z040001
320	F003K31A033	304	F004A33A056	301	F004C20A030	299	F004E22A030.A	300	F004Z040006
320	F003K31B006	304	F004A33H056	301	F004C20A033	299	F004E22A033.A	300	F004Z040012
320	F003K31B018	305	F004A34A056	301	F004C30A001	299	F004E31A001	300	F004Z040018
320	F003K31B033	305	F004A34H056	301	F004C30A006	299	F004E31A006	300	F004Z040030

Page	Reference	Page	Reference	Page	Reference	Page	Reference	Page	Reference
300	F004Z040033	345	F010B22D033	345	F010B42D033	344	F010H21A033	344	F010J31B033
300	F004Z060000	345	F010B31A001	346	F010C22A001	344	F010H21B001	344	F010J31D001
300	F004Z070000	345	F010B31A006	346	F010C22A006	344	F010H21B006	344	F010J31D006
300	F004Z0A0071	345	F010B31A012	346	F010C22A012	344	F010H21B012	344	F010J31D012
300	F004Z0B0000	345	F010B31A018	346	F010C22A018	344	F010H21B018	344	F010J31D018
300	F004Z0C0000	345	F010B31A030	346	F010C22A030	344	F010H21B030	344	F010J31D030
300	F004Z0D0071	345	F010B31A033	346	F010C22A033	344	F010H21B033	344	F010J31D033
300	F004Z0E0071	345	F010B31B001	346	F010C22B001	344	F010H31A001	344	F010J41A001
300	F004Z0F0071	345	F010B31B006	346	F010C22B006	344	F010H31A006	344	F010J41A006
300	F004Z0H0000	345	F010B31B012	346	F010C22B012	344	F010H31A012	344	F010J41A012
305	F004Z0J0000	345	F010B31B018	346	F010C22B018	344	F010H31A018	344	F010J41A018
307	F004Z0K0000	345	F010B31B030	346	F010C22B030	344	F010H31A030	344	F010J41A030
300	F004Z0L0000	345	F010B31B033	346	F010C22B033	344	F010H31A033	344	F010J41A033
342	F010A20H001	345	F010B32A001	346	F010C22D001	344	F010H31B001	344	F010J41B001
342	F010A20H006	345	F010B32A006	346	F010C22D006	344	F010H31B006	344	F010J41B006
342	F010A20H012	345	F010B32A012	346	F010C22D012	344	F010H31B012	344	F010J41B012
342	F010A20H018	345	F010B32A018	346	F010C22D018	344	F010H31B018	344	F010J41B018
342	F010A20H030	345	F010B32A030	346	F010C22D030	344	F010H31B030	344	F010J41B030
342	F010A20H033	345	F010B32A033	346	F010C22D033	344	F010H31B033	344	F010J41B033
342	F010A30H001	345	F010B32B001	346	F010C32A001	344	F010H41A001	344	F010J41D001
342	F010A30H006	345	F010B32B006	346	F010C32A006	344	F010H41A006	344	F010J41D006
342	F010A30H012	345	F010B32B012	346	F010C32A012	344	F010H41A012	344	F010J41D012
342	F010A30H018	345	F010B32B018	346	F010C32A018	344	F010H41A018	344	F010J41D018
342	F010A30H030	345	F010B32B030	346	F010C32A030	344	F010H41A030	344	F010J41D030
342	F010A30H033	345	F010B32B033	346	F010C32A033	344	F010H41A033	344	F010J41D033
342	F010A40H001	345	F010B32D001	346	F010C32B001	344	F010H41B001	246	F011A21F018.A
342	F010A40H006	345	F010B32D006	346	F010C32B006	344	F010H41B006	246	F011A22F030.A
342	F010A40H012	345	F010B32D012	346	F010C32B012	344	F010H41B012	246	F011A22F037.A
342	F010A40H018	345	F010B32D018	346	F010C32B018	344	F010H41B018	246	F011A23F059.A
342	F010A40H030	345	F010B32D030	346	F010C32B030	344	F010H41B030	246	F011A24F055.A
342	F010A40H033	345	F010B32D033	346	F010C32B033	344	F010H41B033	246	F011A31F018.A
345	F010B21A001	345	F010B41A001	346	F010C32D001	344	F010J21A001	246	F011A32F030.A
345	F010B21A006	345	F010B41A006	346	F010C32D006	344	F010J21A006	246	F011A32F037.A
345	F010B21A012	345	F010B41A012	346	F010C32D012	344	F010J21A012	246	F011A33F059.A
345	F010B21A018	345	F010B41A018	346	F010C32D018	344	F010J21A018	246	F011A34F055.A
345	F010B21A030	345	F010B41A030	346	F010C32D030	344	F010J21A030	246	F011A41F018.A
345	F010B21A033	345	F010B41A033	346	F010C32D033	344	F010J21A033	246	F011A42F030.A
345	F010B21B001	345	F010B41B001	346	F010C42A001	344	F010J21B001	246	F011A42F037.A
345	F010B21B006	345	F010B41B006	346	F010C42A006	344	F010J21B006	246	F011A43F059.A
345	F010B21B012	345	F010B41B012	346	F010C42A012	344	F010J21B012	246	F011A44F055.A
345	F010B21B018	345	F010B41B018	346	F010C42A018	344	F010J21B018	248	F011D20A018
345	F010B21B030	345	F010B41B030	346	F010C42A030	344	F010J21B030	248	F011D20A030
345	F010B21B033	345	F010B41B033	346	F010C42A033	344	F010J21B033	248	F011D20A037
345	F010B22A001	345	F010B42A001	346	F010C42B001	344	F010J21D001	248	F011D20A055
345	F010B22A006	345	F010B42A006	346	F010C42B006	344	F010J21D006	248	F011D20A059
345	F010B22A012	345	F010B42A012	346	F010C42B012	344	F010J21D012	248	F011D20B018
345	F010B22A018	345	F010B42A018	346	F010C42B018	344	F010J21D018	248	F011D20B030
345	F010B22A030	345	F010B42A030	346	F010C42B030	344	F010J21D030	248	F011D20B037
345	F010B22A033	345	F010B42A033	346	F010C42B033	344	F010J21D033	248	F011D20B055
345	F010B22B001	345	F010B42B001	346	F010C42D001	344	F010J31A001	248	F011D20B059
345	F010B22B006	345	F010B42B006	346	F010C42D006	344	F010J31A006	248	F011D20D018
345	F010B22B012	345	F010B42B012	346	F010C42D012	344	F010J31A012	248	F011D20D030
345	F010B22B018	345	F010B42B018	346	F010C42D018	344	F010J31A018	248	F011D20D037
345	F010B22B030	345	F010B42B030	346	F010C42D030	344	F010J31A030	248	F011D20D055
345	F010B22B033	345	F010B42B033	346	F010C42D033	344	F010J31A033	248	F011D20D059
345	F010B22D001	345	F010B42D001	344	F010H21A001	344	F010J31B001	248	F011D30A018
345	F010B22D006	345	F010B42D006	344	F010H21A006	344	F010J31B006	248	F011D30A030
345	F010B22D012	345	F010B42D012	344	F010H21A012	344	F010J31B012	248	F011D30A037
345	F010B22D018	345	F010B42D018	344	F010H21A018	344	F010J31B018	248	F011D30A055
345	F010B22D030	345	F010B42D030	344	F010H21A030	344	F010J31B030	248	F011D30A059

Page	Reference	Page	Reference	Page	Reference	Page	Reference	Page	Reference
248	F011D30B018	248	F011E40B018	257	F012B01C018.A	222	F015A41A012	223	F015B41A000
248	F011D30B030	248	F011E40B030	257	F012B02C030.A	222	F015A41A018	223	F015B41A001
248	F011D30B037	248	F011E40B037	257	F012B02C037.A	222	F015A41A030	223	F015B41A006
248	F011D30B055	248	F011E40B055	257	F012B03C059.A	222	F015A41A033	223	F015B41A012
248	F011D30B059	248	F011E40B059	257	F012B04C055.A	222	F015A42A000	223	F015B41A018
248	F011D30D018	248	F011E40D018	256	F012H00C018	222	F015A42A001	223	F015B41A030
248	F011D30D030	248	F011E40D030	256	F012H00C030	222	F015A42A006	223	F015B41A033
248	F011D30D037	248	F011E40D037	256	F012H00C037	222	F015A42A012	223	F015B42A000
248	F011D30D055	248	F011E40D055	256	F012H00C055	222	F015A42A018	223	F015B42A001
248	F011D30D059	248	F011E40D059	256	F012H00C059	222	F015A42A030	223	F015B42A006
248	F011D40A018	247	F011W20A018	256	F012J00C018	222	F015A42A033	223	F015B42A012
248	F011D40A030	247	F011W20A030	256	F012J00C030	224	F015A43A000	223	F015B42A018
248	F011D40A037	247	F011W20A037	256	F012J00C037	224	F015A43A001	223	F015B42A030
248	F011D40A055	247	F011W20A055	256	F012J00C055	224	F015A43A006	223	F015B42A033
248	F011D40A059	247	F011W20A059	256	F012J00C059	224	F015A43A012	224	F015B43A000
248	F011D40B018	247	F011W20B018	222	F015A21A000	224	F015A43A018	224	F015B43A001
248	F011D40B030	247	F011W20B030	222	F015A21A001	224	F015A43A030	224	F015B43A006
248	F011D40B037	247	F011W20B037	222	F015A21A006	224	F015A43A033	224	F015B43A012
248	F011D40B055	247	F011W20B055	222	F015A21A012	223	F015B21A000	224	F015B43A018
248	F011D40B059	247	F011W20B059	222	F015A21A018	223	F015B21A001	224	F015B43A030
248	F011D40D018	247	F011W20D018	222	F015A21A030	223	F015B21A006	224	F015B43A033
248	F011D40D030	247	F011W20D030	222	F015A21A033	223	F015B21A012	225	F015C24A000
248	F011D40D037	247	F011W20D037	222	F015A22A000	223	F015B21A018	225	F015C24A001
248	F011D40D055	247	F011W20D055	222	F015A22A001	223	F015B21A030	225	F015C24A006
248	F011D40D059	247	F011W20D059	222	F015A22A006	223	F015B21A033	225	F015C24A012
248	F011E20A018	247	F011W30A018	222	F015A22A012	223	F015B22A000	225	F015C24A018
248	F011E20A030	247	F011W30A030	222	F015A22A018	223	F015B22A001	225	F015C24A030
248	F011E20A037	247	F011W30A037	222	F015A22A030	223	F015B22A006	225	F015C24A033
248	F011E20A055	247	F011W30A055	222	F015A22A033	223	F015B22A012	225	F015C34A000
248	F011E20A059	247	F011W30A059	224	F015A23A000	223	F015B22A018	225	F015C34A001
248	F011E20B018	247	F011W30B018	224	F015A23A001	223	F015B22A030	225	F015C34A006
248	F011E20B030	247	F011W30B030	224	F015A23A006	223	F015B22A033	225	F015C34A012
248	F011E20B037	247	F011W30B037	224	F015A23A012	224	F015B23A000	225	F015C34A018
248	F011E20B055	247	F011W30B055	224	F015A23A018	224	F015B23A001	225	F015C34A030
248	F011E20B059	247	F011W30B059	224	F015A23A030	224	F015B23A006	225	F015C34A033
248	F011E20D018	247	F011W30D018	224	F015A23A033	224	F015B23A012	225	F015C44A000
248	F011E20D030	247	F011W30D030	222	F015A31A000	224	F015B23A018	225	F015C44A001
248	F011E20D037	247	F011W30D037	222	F015A31A001	224	F015B23A030	225	F015C44A006
248	F011E20D055	247	F011W30D055	222	F015A31A006	224	F015B23A033	225	F015C44A012
248	F011E20D059	247	F011W30D059	222	F015A31A012	223	F015B31A000	225	F015C44A018
248	F011E30A018	247	F011W40A018	222	F015A31A018	223	F015B31A001	225	F015C44A030
248	F011E30A030	247	F011W40A030	222	F015A31A030	223	F015B31A006	225	F015C44A033
248	F011E30A037	247	F011W40A037	222	F015A31A033	223	F015B31A012	225	F015D21A000
248	F011E30A055	247	F011W40A055	222	F015A32A000	223	F015B31A018	225	F015D21A001
248	F011E30A059	247	F011W40A059	222	F015A32A001	223	F015B31A030	225	F015D21A006
248	F011E30B018	247	F011W40B018	222	F015A32A006	223	F015B31A033	225	F015D21A012
248	F011E30B030	247	F011W40B030	222	F015A32A012	223	F015B32A000	225	F015D21A018
248	F011E30B037	247	F011W40B037	222	F015A32A018	223	F015B32A001	225	F015D21A030
248	F011E30B055	247	F011W40B055	222	F015A32A030	223	F015B32A006	225	F015D21A033
248	F011E30B059	247	F011W40B059	222	F015A32A033	223	F015B32A012	225	F015D21B000
248	F011E30D018	247	F011W40D018	224	F015A33A000	223	F015B32A018	225	F015D21B001
248	F011E30D030	247	F011W40D030	224	F015A33A001	223	F015B32A030	225	F015D21B006
248	F011E30D037	247	F011W40D037	224	F015A33A006	223	F015B32A033	225	F015D21B012
248	F011E30D055	247	F011W40D055	224	F015A33A012	224	F015B33A000	225	F015D21B018
248	F011E30D059	247	F011W40D059	224	F015A33A018	224	F015B33A001	225	F015D21B030
248	F011E40A018	257	F012A01C018.A	224	F015A33A030	224	F015B33A006	225	F015D21B033
248	F011E40A030	257	F012A02C030.A	224	F015A33A033	224	F015B33A012	225	F015D21D000
248	F011E40A037	257	F012A02C037.A	222	F015A41A000	224	F015B33A018	225	F015D21D001
248	F011E40A055	257	F012A03C059.A	222	F015A41A001	224	F015B33A030	225	F015D21D006
248	F011E40A059	257	F012A04C055.A	222	F015A41A006	224	F015B33A033	225	F015D21D012

Page	Reference	Page	Reference	Page	Reference	Page	Reference	Page	Reference
225	F015D21D018	225	F015D31D001	225	F015D41B030	227	F015E21B006	227	F015E31A033
225	F015D21D030	225	F015D31D006	225	F015D41B033	227	F015E21B012	227	F015E31B000
225	F015D21D033	225	F015D31D012	225	F015D41D000	227	F015E21B018	227	F015E31B001
226	F015D22A000	225	F015D31D018	225	F015D41D001	227	F015E21B030	227	F015E31B006
226	F015D22A001	225	F015D31D030	225	F015D41D006	227	F015E21B033	227	F015E31B012
226	F015D22A006	225	F015D31D033	225	F015D41D012	227	F015E21D000	227	F015E31B018
226	F015D22A012	226	F015D32A000	225	F015D41D018	227	F015E21D001	227	F015E31B030
226	F015D22A018	226	F015D32A001	225	F015D41D030	227	F015E21D006	227	F015E31B033
226	F015D22A030	226	F015D32A006	225	F015D41D033	227	F015E21D012	227	F015E31D000
226	F015D22A033	226	F015D32A012	226	F015D42A000	227	F015E21D018	227	F015E31D001
226	F015D22B000	226	F015D32A018	226	F015D42A001	227	F015E21D030	227	F015E31D006
226	F015D22B001	226	F015D32A030	226	F015D42A006	227	F015E21D033	227	F015E31D012
226	F015D22B006	226	F015D32A033	226	F015D42A012	228	F015E22A000	227	F015E31D018
226	F015D22B012	226	F015D32B000	226	F015D42A018	228	F015E22A001	227	F015E31D030
226	F015D22B018	226	F015D32B001	226	F015D42A030	228	F015E22A006	227	F015E31D033
226	F015D22B030	226	F015D32B006	226	F015D42A033	228	F015E22A012	228	F015E32A000
226	F015D22B033	226	F015D32B012	226	F015D42B000	228	F015E22A018	228	F015E32A001
226	F015D22D000	226	F015D32B018	226	F015D42B001	228	F015E22A030	228	F015E32A006
226	F015D22D001	226	F015D32B030	226	F015D42B006	228	F015E22A033	228	F015E32A012
226	F015D22D006	226	F015D32B033	226	F015D42B012	228	F015E22B000	228	F015E32A018
226	F015D22D012	226	F015D32D000	226	F015D42B018	228	F015E22B001	228	F015E32A030
226	F015D22D018	226	F015D32D001	226	F015D42B030	228	F015E22B006	228	F015E32A033
226	F015D22D030	226	F015D32D006	226	F015D42B033	228	F015E22B012	228	F015E32B000
226	F015D22D033	226	F015D32D012	226	F015D42D000	228	F015E22B018	228	F015E32B001
229	F015D23A000	226	F015D32D018	226	F015D42D001	228	F015E22B030	228	F015E32B006
229	F015D23A001	226	F015D32D030	226	F015D42D006	228	F015E22B033	228	F015E32B012
229	F015D23A006	226	F015D32D033	226	F015D42D012	228	F015E22D000	228	F015E32B018
229	F015D23A012	229	F015D33A000	226	F015D42D018	228	F015E22D001	228	F015E32B030
229	F015D23A018	229	F015D33A001	226	F015D42D030	228	F015E22D006	228	F015E32B033
229	F015D23A030	229	F015D33A006	226	F015D42D033	228	F015E22D012	228	F015E32D000
229	F015D23A033	229	F015D33A012	229	F015D43A000	228	F015E22D018	228	F015E32D001
229	F015D23B000	229	F015D33A018	229	F015D43A001	228	F015E22D030	228	F015E32D006
229	F015D23B001	229	F015D33A030	229	F015D43A006	228	F015E22D033	228	F015E32D012
229	F015D23B006	229	F015D33A033	229	F015D43A012	230	F015E23A000	228	F015E32D018
229	F015D23B012	229	F015D33B000	229	F015D43A018	230	F015E23A001	228	F015E32D030
229	F015D23B018	229	F015D33B001	229	F015D43A030	230	F015E23A006	228	F015E32D033
229	F015D23B030	229	F015D33B006	229	F015D43A033	230	F015E23A012	230	F015E33A000
229	F015D23B033	229	F015D33B012	229	F015D43B000	230	F015E23A018	230	F015E33A001
229	F015D23D000	229	F015D33B018	229	F015D43B001	230	F015E23A030	230	F015E33A006
229	F015D23D001	229	F015D33B030	229	F015D43B006	230	F015E23A033	230	F015E33A012
229	F015D23D006	229	F015D33B033	229	F015D43B012	230	F015E23B000	230	F015E33A018
229	F015D23D012	229	F015D33D000	229	F015D43B018	230	F015E23B001	230	F015E33A030
229	F015D23D018	229	F015D33D001	229	F015D43B030	230	F015E23B006	230	F015E33A033
229	F015D23D030	229	F015D33D006	229	F015D43B033	230	F015E23B012	230	F015E33B000
229	F015D23D033	229	F015D33D012	229	F015D43D000	230	F015E23B018	230	F015E33B001
225	F015D31A000	229	F015D33D018	229	F015D43D001	230	F015E23B030	230	F015E33B006
225	F015D31A001	229	F015D33D030	229	F015D43D006	230	F015E23B033	230	F015E33B012
225	F015D31A006	229	F015D33D033	229	F015D43D012	230	F015E23D000	230	F015E33B018
225	F015D31A012	225	F015D41A000	229	F015D43D018	230	F015E23D001	230	F015E33B030
225	F015D31A018	225	F015D41A001	229	F015D43D030	230	F015E23D006	230	F015E33B033
225	F015D31A030	225	F015D41A006	229	F015D43D033	230	F015E23D012	230	F015E33D000
225	F015D31A033	225	F015D41A012	227	F015E21A000	230	F015E23D018	230	F015E33D001
225	F015D31B000	225	F015D41A018	227	F015E21A001	230	F015E23D030	230	F015E33D006
225	F015D31B001	225	F015D41A030	227	F015E21A006	230	F015E23D033	230	F015E33D012
225	F015D31B006	225	F015D41A033	227	F015E21A012	227	F015E31A000	230	F015E33D018
225	F015D31B012	225	F015D41B000	227	F015E21A018	227	F015E31A001	230	F015E33D030
225	F015D31B018	225	F015D41B001	227	F015E21A030	227	F015E31A006	230	F015E33D033
225	F015D31B030	225	F015D41B006	227	F015E21A033	227	F015E31A012	227	F015E41A000
225	F015D31B033	225	F015D41B012	227	F015E21B000	227	F015E31A018	227	F015E41A001
225	F015D31D000	225	F015D41B018	227	F015E21B001	227	F015E31A030	227	F015E41A006

Page	Reference	Page	Reference	Page	Reference	Page	Reference	Page	Reference
227	F015E41A012	231	F015F24A000	231	F015F44D018	215	F015H32A018	216	F015J31B018
227	F015E41A018	231	F015F24A001	231	F015F44D030	215	F015H32A030	216	F015J31B030
227	F015E41A030	231	F015F24A006	231	F015F44D033	215	F015H32A033	216	F015J31B033
227	F015E41A033	231	F015F24A012	214	F015G21A001	215	F015H41A001	216	F015J31D001
227	F015E41B000	231	F015F24A018	214	F015G21A006	215	F015H41A006	216	F015J31D006
227	F015E41B001	231	F015F24A030	214	F015G21A012	215	F015H41A012	216	F015J31D012
227	F015E41B006	231	F015F24A033	214	F015G21A018	215	F015H41A018	216	F015J31D018
227	F015E41B012	231	F015F24B000	214	F015G21A030	215	F015H41A030	216	F015J31D030
227	F015E41B018	231	F015F24B001	214	F015G21A033	215	F015H41A033	216	F015J31D033
227	F015E41B030	231	F015F24B006	214	F015G22A001	215	F015H42A001	217	F015J32A001
227	F015E41B033	231	F015F24B012	214	F015G22A006	215	F015H42A006	217	F015J32A006
227	F015E41D000	231	F015F24B018	214	F015G22A012	215	F015H42A012	217	F015J32A012
227	F015E41D001	231	F015F24B030	214	F015G22A018	215	F015H42A018	217	F015J32A018
227	F015E41D006	231	F015F24B033	214	F015G22A030	215	F015H42A030	217	F015J32A030
227	F015E41D012	231	F015F24D000	214	F015G22A033	215	F015H42A033	217	F015J32A033
227	F015E41D018	231	F015F24D001	214	F015G31A001	216	F015J21A001	217	F015J32B001
227	F015E41D030	231	F015F24D006	214	F015G31A006	216	F015J21A006	217	F015J32B006
227	F015E41D033	231	F015F24D012	214	F015G31A012	216	F015J21A012	217	F015J32B012
228	F015E42A000	231	F015F24D018	214	F015G31A018	216	F015J21A018	217	F015J32B018
228	F015E42A001	231	F015F24D030	214	F015G31A030	216	F015J21A030	217	F015J32B030
228	F015E42A006	231	F015F24D033	214	F015G31A033	216	F015J21A033	217	F015J32B033
228	F015E42A012	231	F015F34A000	214	F015G32A001	216	F015J21B001	217	F015J32D001
228	F015E42A018	231	F015F34A001	214	F015G32A006	216	F015J21B006	217	F015J32D006
228	F015E42A030	231	F015F34A006	214	F015G32A012	216	F015J21B012	217	F015J32D012
228	F015E42A033	231	F015F34A012	214	F015G32A018	216	F015J21B018	217	F015J32D018
228	F015E42B000	231	F015F34A018	214	F015G32A030	216	F015J21B030	217	F015J32D030
228	F015E42B001	231	F015F34A030	214	F015G32A033	216	F015J21B033	217	F015J32D033
228	F015E42B006	231	F015F34A033	214	F015G41A001	216	F015J21D001	216	F015J41A001
228	F015E42B012	231	F015F34B000	214	F015G41A006	216	F015J21D006	216	F015J41A006
228	F015E42B018	231	F015F34B001	214	F015G41A012	216	F015J21D012	216	F015J41A012
228	F015E42B030	231	F015F34B006	214	F015G41A018	216	F015J21D018	216	F015J41A018
228	F015E42B033	231	F015F34B012	214	F015G41A030	216	F015J21D030	216	F015J41A030
228	F015E42D000	231	F015F34B018	214	F015G41A033	216	F015J21D033	216	F015J41A033
228	F015E42D001	231	F015F34B030	214	F015G42A001	217	F015J22A001	216	F015J41B001
228	F015E42D006	231	F015F34B033	214	F015G42A006	217	F015J22A006	216	F015J41B006
228	F015E42D012	231	F015F34D000	214	F015G42A012	217	F015J22A012	216	F015J41B012
228	F015E42D018	231	F015F34D001	214	F015G42A018	217	F015J22A018	216	F015J41B018
228	F015E42D030	231	F015F34D006	214	F015G42A030	217	F015J22A030	216	F015J41B030
228	F015E42D033	231	F015F34D012	214	F015G42A033	217	F015J22A033	216	F015J41B033
230	F015E43A000	231	F015F34D018	215	F015H21A001	217	F015J22B001	216	F015J41D001
230	F015E43A001	231	F015F34D030	215	F015H21A006	217	F015J22B006	216	F015J41D006
230	F015E43A006	231	F015F34D033	215	F015H21A012	217	F015J22B012	216	F015J41D012
230	F015E43A012	231	F015F44A000	215	F015H21A018	217	F015J22B018	216	F015J41D018
230	F015E43A018	231	F015F44A001	215	F015H21A030	217	F015J22B030	216	F015J41D030
230	F015E43A030	231	F015F44A006	215	F015H21A033	217	F015J22B033	216	F015J41D033
230	F015E43A033	231	F015F44A012	215	F015H22A001	217	F015J22D001	217	F015J42A001
230	F015E43B000	231	F015F44A018	215	F015H22A006	217	F015J22D006	217	F015J42A006
230	F015E43B001	231	F015F44A030	215	F015H22A012	217	F015J22D012	217	F015J42A012
230	F015E43B006	231	F015F44A033	215	F015H22A018	217	F015J22D018	217	F015J42A018
230	F015E43B012	231	F015F44B000	215	F015H22A030	217	F015J22D030	217	F015J42A030
230	F015E43B018	231	F015F44B001	215	F015H22A033	217	F015J22D033	217	F015J42A033
230	F015E43B030	231	F015F44B006	215	F015H31A001	216	F015J31A001	217	F015J42B001
230	F015E43B033	231	F015F44B012	215	F015H31A006	216	F015J31A006	217	F015J42B006
230	F015E43D000	231	F015F44B018	215	F015H31A012	216	F015J31A012	217	F015J42B012
230	F015E43D001	231	F015F44B030	215	F015H31A018	216	F015J31A018	217	F015J42B018
230	F015E43D006	231	F015F44B033	215	F015H31A030	216	F015J31A030	217	F015J42B030
230	F015E43D012	231	F015F44D000	215	F015H31A033	216	F015J31A033	217	F015J42B033
230	F015E43D018	231	F015F44D001	215	F015H32A001	216	F015J31B001	217	F015J42D001
230	F015E43D030	231	F015F44D006	215	F015H32A006	216	F015J31B006	217	F015J42D006
230	F015E43D033	231	F015F44D012	215	F015H32A012	216	F015J31B012	217	F015J42D012

Page	Reference	Page	Reference	Page	Reference	Page	Reference	Page	Reference
217	F015J42D018	219	F015K32A018	220	F015L30A006	221	F015M40A033	272	F016A23B006
217	F015J42D030	219	F015K32A030	220	F015L30A012	221	F015M40B000	272	F016A23B012
217	F015J42D033	219	F015K32A033	220	F015L30A018	221	F015M40B001	272	F016A23B018
218	F015K21A001	219	F015K32B001	220	F015L30A030	221	F015M40B006	272	F016A23B030
218	F015K21A006	219	F015K32B006	220	F015L30A033	221	F015M40B012	272	F016A23B033
218	F015K21A012	219	F015K32B012	220	F015L40A000	221	F015M40B018	272	F016A23D001
218	F015K21A018	219	F015K32B018	220	F015L40A001	221	F015M40B030	272	F016A23D006
218	F015K21A030	219	F015K32B030	220	F015L40A006	221	F015M40B033	272	F016A23D012
218	F015K21A033	219	F015K32B033	220	F015L40A012	221	F015M40D000	272	F016A23D018
218	F015K21B001	219	F015K32D001	220	F015L40A018	221	F015M40D001	272	F016A23D030
218	F015K21B006	219	F015K32D006	220	F015L40A030	221	F015M40D006	272	F016A23D033
218	F015K21B012	219	F015K32D012	220	F015L40A033	221	F015M40D012	268	F016A31A001
218	F015K21B018	219	F015K32D018	221	F015M20A000	221	F015M40D018	268	F016A31A006
218	F015K21B030	219	F015K32D030	221	F015M20A001	221	F015M40D030	268	F016A31A012
218	F015K21B033	219	F015K32D033	221	F015M20A006	221	F015M40D033	268	F016A31A018
218	F015K21D001	218	F015K41A001	221	F015M20A012	219	F015Z000000	268	F016A31A030
218	F015K21D006	218	F015K41A006	221	F015M20A018	219	F015Z010000	268	F016A31A033
218	F015K21D012	218	F015K41A012	221	F015M20A030	268	F016A21A001	268	F016A31B001
218	F015K21D018	218	F015K41A018	221	F015M20A033	268	F016A21A006	268	F016A31B006
218	F015K21D030	218	F015K41A030	221	F015M20B000	268	F016A21A012	268	F016A31B012
218	F015K21D033	218	F015K41A033	221	F015M20B001	268	F016A21A018	268	F016A31B018
219	F015K22A001	218	F015K41B001	221	F015M20B006	268	F016A21A030	268	F016A31B030
219	F015K22A006	218	F015K41B006	221	F015M20B012	268	F016A21A033	268	F016A31B033
219	F015K22A012	218	F015K41B012	221	F015M20B018	268	F016A21B001	268	F016A31D001
219	F015K22A018	218	F015K41B018	221	F015M20B030	268	F016A21B006	268	F016A31D006
219	F015K22A030	218	F015K41B030	221	F015M20B033	268	F016A21B012	268	F016A31D012
219	F015K22A033	218	F015K41B033	221	F015M20D000	268	F016A21B018	268	F016A31D018
219	F015K22B001	218	F015K41D001	221	F015M20D001	268	F016A21B030	268	F016A31D030
219	F015K22B006	218	F015K41D006	221	F015M20D006	268	F016A21B033	268	F016A31D033
219	F015K22B012	218	F015K41D012	221	F015M20D012	268	F016A21D001	270	F016A32A001
219	F015K22B018	218	F015K41D018	221	F015M20D018	268	F016A21D006	270	F016A32A006
219	F015K22B030	218	F015K41D030	221	F015M20D030	268	F016A21D012	270	F016A32A012
219	F015K22B033	218	F015K41D033	221	F015M20D033	268	F016A21D018	270	F016A32A018
219	F015K22D001	219	F015K42A001	221	F015M30A000	268	F016A21D030	270	F016A32A030
219	F015K22D006	219	F015K42A006	221	F015M30A001	268	F016A21D033	270	F016A32A033
219	F015K22D012	219	F015K42A012	221	F015M30A006	270	F016A22A001	270	F016A32B001
219	F015K22D018	219	F015K42A018	221	F015M30A012	270	F016A22A006	270	F016A32B006
219	F015K22D030	219	F015K42A030	221	F015M30A018	270	F016A22A012	270	F016A32B012
219	F015K22D033	219	F015K42A033	221	F015M30A030	270	F016A22A018	270	F016A32B018
218	F015K31A001	219	F015K42B001	221	F015M30A033	270	F016A22A030	270	F016A32B030
218	F015K31A006	219	F015K42B006	221	F015M30B000	270	F016A22A033	270	F016A32B033
218	F015K31A012	219	F015K42B012	221	F015M30B001	270	F016A22B001	270	F016A32D001
218	F015K31A018	219	F015K42B018	221	F015M30B006	270	F016A22B006	270	F016A32D006
218	F015K31A030	219	F015K42B030	221	F015M30B012	270	F016A22B012	270	F016A32D012
218	F015K31A033	219	F015K42B033	221	F015M30B018	270	F016A22B018	270	F016A32D018
218	F015K31B001	219	F015K42D001	221	F015M30B030	270	F016A22B030	270	F016A32D030
218	F015K31B006	219	F015K42D006	221	F015M30B033	270	F016A22B033	270	F016A32D033
218	F015K31B012	219	F015K42D012	221	F015M30D000	270	F016A22D001	272	F016A33A001
218	F015K31B018	219	F015K42D018	221	F015M30D001	270	F016A22D006	272	F016A33A006
218	F015K31B030	219	F015K42D030	221	F015M30D006	270	F016A22D012	272	F016A33A012
218	F015K31B033	219	F015K42D033	221	F015M30D012	270	F016A22D018	272	F016A33A018
218	F015K31D001	220	F015L20A000	221	F015M30D018	270	F016A22D030	272	F016A33A030
218	F015K31D006	220	F015L20A001	221	F015M30D030	270	F016A22D033	272	F016A33A033
218	F015K31D012	220	F015L20A006	221	F015M30D033	272	F016A23A001	272	F016A33B001
218	F015K31D018	220	F015L20A012	221	F015M40A000	272	F016A23A006	272	F016A33B006
218	F015K31D030	220	F015L20A018	221	F015M40A001	272	F016A23A012	272	F016A33B012
218	F015K31D033	220	F015L20A030	221	F015M40A006	272	F016A23A018	272	F016A33B018
219	F015K32A001	220	F015L20A033	221	F015M40A012	272	F016A23A030	272	F016A33B030
219	F015K32A006	220	F015L30A000	221	F015M40A018	272	F016A23A033	272	F016A33B033
219	F015K32A012	220	F015L30A001	221	F015M40A030	272	F016A23B001	272	F016A33D001

Page	Reference	Page	Reference	Page	Reference	Page	Reference	Page	Reference
272	F016A33D006	269	F016B21A006	269	F016B31B006	269	F016B41D006	267	F016M24K006.A
272	F016A33D012	269	F016B21A012	269	F016B31B012	269	F016B41D012	267	F016M24K012.A
272	F016A33D018	269	F016B21A018	269	F016B31B018	269	F016B41D018	267	F016M24K018.A
272	F016A33D030	269	F016B21A030	269	F016B31B030	269	F016B41D030	267	F016M24K030.A
272	F016A33D033	269	F016B21A033	269	F016B31B033	269	F016B41D033	267	F016M24K033.A
268	F016A41A001	269	F016B21B001	269	F016B31D001	271	F016B42A001	267	F016M25K001.A
268	F016A41A006	269	F016B21B006	269	F016B31D006	271	F016B42A006	267	F016M25K006.A
268	F016A41A012	269	F016B21B012	269	F016B31D012	271	F016B42A012	267	F016M25K012.A
268	F016A41A018	269	F016B21B018	269	F016B31D018	271	F016B42A018	267	F016M25K018.A
268	F016A41A030	269	F016B21B030	269	F016B31D030	271	F016B42A030	267	F016M25K030.A
268	F016A41A033	269	F016B21B033	269	F016B31D033	271	F016B42A033	267	F016M25K033.A
268	F016A41B001	269	F016B21D001	271	F016B32A001	271	F016B42B001	264	F016M31K001.A
268	F016A41B006	269	F016B21D006	271	F016B32A006	271	F016B42B006	264	F016M31K006.A
268	F016A41B012	269	F016B21D012	271	F016B32A012	271	F016B42B012	264	F016M31K012.A
268	F016A41B018	269	F016B21D018	271	F016B32A018	271	F016B42B018	264	F016M31K018.A
268	F016A41B030	269	F016B21D030	271	F016B32A030	271	F016B42B030	264	F016M31K030.A
268	F016A41B033	269	F016B21D033	271	F016B32A033	271	F016B42B033	264	F016M31K033.A
268	F016A41D001	271	F016B22A001	271	F016B32B001	271	F016B42D001	265	F016M32K001.A
268	F016A41D006	271	F016B22A006	271	F016B32B006	271	F016B42D006	265	F016M32K006.A
268	F016A41D012	271	F016B22A012	271	F016B32B012	271	F016B42D012	265	F016M32K012.A
268	F016A41D018	271	F016B22A018	271	F016B32B018	271	F016B42D018	265	F016M32K018.A
268	F016A41D030	271	F016B22A030	271	F016B32B030	271	F016B42D030	265	F016M32K030.A
268	F016A41D033	271	F016B22A033	271	F016B32B033	271	F016B42D033	265	F016M32K033.A
270	F016A42A001	271	F016B22B001	271	F016B32D001	273	F016B43A001	266	F016M33K001.A
270	F016A42A006	271	F016B22B006	271	F016B32D006	273	F016B43A006	266	F016M33K006.A
270	F016A42A012	271	F016B22B012	271	F016B32D012	273	F016B43A012	266	F016M33K012.A
270	F016A42A018	271	F016B22B018	271	F016B32D018	273	F016B43A018	266	F016M33K018.A
270	F016A42A030	271	F016B22B030	271	F016B32D030	273	F016B43A030	266	F016M33K030.A
270	F016A42A033	271	F016B22B033	271	F016B32D033	273	F016B43A033	266	F016M33K033.A
270	F016A42B001	271	F016B22D001	273	F016B33A001	273	F016B43B001	267	F016M34K001.A
270	F016A42B006	271	F016B22D006	273	F016B33A006	273	F016B43B006	267	F016M34K006.A
270	F016A42B012	271	F016B22D012	273	F016B33A012	273	F016B43B012	267	F016M34K012.A
270	F016A42B018	271	F016B22D018	273	F016B33A018	273	F016B43B018	267	F016M34K018.A
270	F016A42B030	271	F016B22D030	273	F016B33A030	273	F016B43B030	267	F016M34K030.A
270	F016A42B033	271	F016B22D033	273	F016B33A033	273	F016B43B033	267	F016M34K033.A
270	F016A42D001	273	F016B23A001	273	F016B33B001	273	F016B43D001	267	F016M35K001.A
270	F016A42D006	273	F016B23A006	273	F016B33B006	273	F016B43D006	267	F016M35K006.A
270	F016A42D012	273	F016B23A012	273	F016B33B012	273	F016B43D012	267	F016M35K012.A
270	F016A42D018	273	F016B23A018	273	F016B33B018	273	F016B43D018	267	F016M35K018.A
270	F016A42D030	273	F016B23A030	273	F016B33B030	273	F016B43D030	267	F016M35K030.A
270	F016A42D033	273	F016B23A033	273	F016B33B033	273	F016B43D033	267	F016M35K033.A
272	F016A43A001	273	F016B23B001	273	F016B33D001	264	F016M21K001.A	264	F016M41K001.A
272	F016A43A006	273	F016B23B006	273	F016B33D006	264	F016M21K006.A	264	F016M41K006.A
272	F016A43A012	273	F016B23B012	273	F016B33D012	264	F016M21K012.A	264	F016M41K012.A
272	F016A43A018	273	F016B23B018	273	F016B33D018	264	F016M21K018.A	264	F016M41K018.A
272	F016A43A030	273	F016B23B030	273	F016B33D030	264	F016M21K030.A	264	F016M41K030.A
272	F016A43A033	273	F016B23B033	273	F016B33D033	264	F016M21K033.A	264	F016M41K033.A
272	F016A43B001	273	F016B23D001	269	F016B41A001	265	F016M22K001.A	265	F016M42K001.A
272	F016A43B006	273	F016B23D006	269	F016B41A006	265	F016M22K006.A	265	F016M42K006.A
272	F016A43B012	273	F016B23D012	269	F016B41A012	265	F016M22K012.A	265	F016M42K012.A
272	F016A43B018	273	F016B23D018	269	F016B41A018	265	F016M22K018.A	265	F016M42K018.A
272	F016A43B030	273	F016B23D030	269	F016B41A030	265	F016M22K030.A	265	F016M42K030.A
272	F016A43B033	273	F016B23D033	269	F016B41A033	265	F016M22K033.A	265	F016M42K033.A
272	F016A43D001	269	F016B31A001	269	F016B41B001	266	F016M23K001.A	266	F016M43K001.A
272	F016A43D006	269	F016B31A006	269	F016B41B006	266	F016M23K006.A	266	F016M43K006.A
272	F016A43D012	269	F016B31A012	269	F016B41B012	266	F016M23K012.A	266	F016M43K012.A
272	F016A43D018	269	F016B31A018	269	F016B41B018	266	F016M23K018.A	266	F016M43K018.A
272	F016A43D030	269	F016B31A030	269	F016B41B030	266	F016M23K030.A	266	F016M43K030.A
272	F016A43D033	269	F016B31A033	269	F016B41B033	266	F016M23K033.A	266	F016M43K033.A
269	F016B21A001	269	F016B31B001	269	F016B41D001	267	F016M24K001.A	267	F016M44K001.A

Page	Reference	Page	Reference	Page	Reference	Page	Reference	Page	Reference
267	F016M44K006.A	266	F016N43K006.A	554	F017A1RA006	553	F017A2LA006	553	F017A3JA006
267	F016M44K012.A	266	F016N43K012.A	554	F017A1RA033	553	F017A2LA033	553	F017A3JA033
267	F016M44K018.A	266	F016N43K018.A	554	F017A1RB006	553	F017A2LB006	553	F017A3JB006
267	F016M44K030.A	266	F016N43K030.A	554	F017A1RB033	553	F017A2LB033	553	F017A3JB033
267	F016M44K033.A	266	F016N43K033.A	554	F017A1RD006	553	F017A2LD006	553	F017A3JD006
267	F016M45K001.A	273	F016Z000000	554	F017A1RD033	553	F017A2LD033	553	F017A3JD033
267	F016M45K006.A	552	F017A1AA006	554	F017A1SA006	554	F017A2QA006	553	F017A3KA006
267	F016M45K012.A	552	F017A1AA033	554	F017A1SA033	554	F017A2QA033	553	F017A3KA033
267	F016M45K018.A	552	F017A1AB006	554	F017A1SB006	554	F017A2QB006	553	F017A3KB006
267	F016M45K030.A	552	F017A1AB033	554	F017A1SB033	554	F017A2QB033	553	F017A3KB033
267	F016M45K033.A	552	F017A1AD006	554	F017A1SD006	554	F017A2QD006	553	F017A3KD006
264	F016N21K001.A	552	F017A1AD033	554	F017A1SD033	554	F017A2QD033	553	F017A3KD033
264	F016N21K006.A	552	F017A1BA006	554	F017A1TA006	554	F017A2RA006	553	F017A3LA006
264	F016N21K012.A	552	F017A1BA033	554	F017A1TA033	554	F017A2RA033	553	F017A3LA033
264	F016N21K018.A	552	F017A1BB006	554	F017A1TB006	554	F017A2RB006	553	F017A3LB006
264	F016N21K030.A	552	F017A1BB033	554	F017A1TB033	554	F017A2RB033	553	F017A3LB033
264	F016N21K033.A	552	F017A1BD006	554	F017A1TD006	554	F017A2RD006	553	F017A3LD006
265	F016N22K001.A	552	F017A1BD033	554	F017A1TD033	554	F017A2RD033	553	F017A3LD033
265	F016N22K006.A	552	F017A1CA006	552	F017A2AA006	554	F017A2SA006	554	F017A3QA006
265	F016N22K012.A	552	F017A1CA033	552	F017A2AA033	554	F017A2SA033	554	F017A3QA033
265	F016N22K018.A	552	F017A1CB006	552	F017A2AB006	554	F017A2SB006	554	F017A3QB006
265	F016N22K030.A	552	F017A1CB033	552	F017A2AB033	554	F017A2SB033	554	F017A3QB033
265	F016N22K033.A	552	F017A1CD006	552	F017A2AD006	554	F017A2SD006	554	F017A3QD006
266	F016N23K001.A	552	F017A1CD033	552	F017A2AD033	554	F017A2SD033	554	F017A3QD033
266	F016N23K006.A	552	F017A1DA006	552	F017A2BA006	554	F017A2TA006	554	F017A3RA006
266	F016N23K012.A	552	F017A1DA033	552	F017A2BA033	554	F017A2TA033	554	F017A3RA033
266	F016N23K018.A	552	F017A1DB006	552	F017A2BB006	554	F017A2TB006	554	F017A3RB006
266	F016N23K030.A	552	F017A1DB033	552	F017A2BB033	554	F017A2TB033	554	F017A3RB033
266	F016N23K033.A	552	F017A1DD006	552	F017A2BD006	554	F017A2TD006	554	F017A3RD006
264	F016N31K001.A	552	F017A1DD033	552	F017A2BD033	554	F017A2TD033	554	F017A3RD033
264	F016N31K006.A	553	F017A1HA006	552	F017A2CA006	552	F017A3AA006	554	F017A3SA006
264	F016N31K012.A	553	F017A1HA033	552	F017A2CA033	552	F017A3AA033	554	F017A3SA033
264	F016N31K018.A	553	F017A1HB006	552	F017A2CB006	552	F017A3AB006	554	F017A3SB006
264	F016N31K030.A	553	F017A1HB033	552	F017A2CB033	552	F017A3AB033	554	F017A3SB033
264	F016N31K033.A	553	F017A1HD006	552	F017A2CD006	552	F017A3AD006	554	F017A3SD006
265	F016N32K001.A	553	F017A1HD033	552	F017A2CD033	552	F017A3AD033	554	F017A3SD033
265	F016N32K006.A	553	F017A1JA006	552	F017A2DA006	552	F017A3BA006	554	F017A3TA006
265	F016N32K012.A	553	F017A1JA033	552	F017A2DA033	552	F017A3BA033	554	F017A3TA033
265	F016N32K018.A	553	F017A1JB006	552	F017A2DB006	552	F017A3BB006	554	F017A3TB006
265	F016N32K030.A	553	F017A1JB033	552	F017A2DB033	552	F017A3BB033	554	F017A3TB033
265	F016N32K033.A	553	F017A1JD006	552	F017A2DD006	552	F017A3BD006	554	F017A3TD006
266	F016N33K001.A	553	F017A1JD033	552	F017A2DD033	552	F017A3BD033	554	F017A3TD033
266	F016N33K006.A	553	F017A1KA006	553	F017A2HA006	552	F017A3CA006	552	F017A4AA006
266	F016N33K012.A	553	F017A1KA033	553	F017A2HA033	552	F017A3CA033	552	F017A4AA033
266	F016N33K018.A	553	F017A1KB006	553	F017A2HB006	552	F017A3CB006	552	F017A4AB006
266	F016N33K030.A	553	F017A1KB033	553	F017A2HB033	552	F017A3CB033	552	F017A4AB033
266	F016N33K033.A	553	F017A1KD006	553	F017A2HD006	552	F017A3CD006	552	F017A4AD006
264	F016N41K001.A	553	F017A1KD033	553	F017A2HD033	552	F017A3CD033	552	F017A4AD033
264	F016N41K006.A	553	F017A1LA006	553	F017A2JA006	552	F017A3DA006	552	F017A4BA006
264	F016N41K012.A	553	F017A1LA033	553	F017A2JA033	552	F017A3DA033	552	F017A4BA033
264	F016N41K018.A	553	F017A1LB006	553	F017A2JB006	552	F017A3DB006	552	F017A4BB006
264	F016N41K030.A	553	F017A1LB033	553	F017A2JB033	552	F017A3DB033	552	F017A4BB033
264	F016N41K033.A	553	F017A1LD006	553	F017A2JD006	552	F017A3DD006	552	F017A4BD006
265	F016N42K001.A	553	F017A1LD033	553	F017A2JD033	552	F017A3DD033	552	F017A4BD033
265	F016N42K006.A	554	F017A1QA006	553	F017A2KA006	553	F017A3HA006	552	F017A4CA006
265	F016N42K012.A	554	F017A1QA033	553	F017A2KA033	553	F017A3HA033	552	F017A4CA033
265	F016N42K018.A	554	F017A1QB006	553	F017A2KB006	553	F017A3HB006	552	F017A4CB006
265	F016N42K030.A	554	F017A1QB033	553	F017A2KB033	553	F017A3HB033	552	F017A4CB033
265	F016N42K033.A	554	F017A1QD006	553	F017A2KD006	553	F017A3HD006	552	F017A4CD006
266	F016N43K001.A	554	F017A1QD033	553	F017A2KD033	553	F017A3HD033	552	F017A4CD033

Page	Reference	Page	Reference	Page	Reference	Page	Reference	Page	Reference
598	F017R2LA006	598	F017R3JA006	597	F017R4DA006	600	F017Z130000	193	F018A22D001
598	F017R2LA033	598	F017R3JA033	597	F017R4DA033	600	F017Z140000	193	F018A22D012
598	F017R2LB006	598	F017R3JB006	597	F017R4DB006	602	F017Z210000	193	F018A22D013
598	F017R2LB033	598	F017R3JB033	597	F017R4DB033	602	F017Z211000	193	F018A22D018
598	F017R2LD006	598	F017R3JD006	597	F017R4DD006	602	F017Z220000	193	F018A22D025
598	F017R2LD033	598	F017R3JD033	597	F017R4DD033	602	F017Z221000	193	F018A22D030
599	F017R2QA006	598	F017R3KA006	598	F017R4HA006	602	F017Z230000	193	F018A22D033
599	F017R2QA033	598	F017R3KA033	598	F017R4HA033	602	F017Z231000	193	F018A23A001
599	F017R2QB006	598	F017R3KB006	598	F017R4HB006	602	F017Z240000	193	F018A23A012
599	F017R2QB033	598	F017R3KB033	598	F017R4HB033	602	F017Z241000	193	F018A23A013
599	F017R2QD006	598	F017R3KD006	598	F017R4HD006	602	F017Z490000	193	F018A23A018
599	F017R2QD033	598	F017R3KD033	598	F017R4HD033	602	F017Z530000	193	F018A23A025
599	F017R2RA006	598	F017R3LA006	598	F017R4JA006	602	F017Z531000	193	F018A23A030
599	F017R2RA033	598	F017R3LA033	598	F017R4JA033	600	F017Z550006	193	F018A23A033
599	F017R2RB006	598	F017R3LB006	598	F017R4JB006	600	F017Z550033	193	F018A23B001
599	F017R2RB033	598	F017R3LB033	598	F017R4JB033	600	F017Z560006	193	F018A23B012
599	F017R2RD006	598	F017R3LD006	598	F017R4JD006	600	F017Z560033	193	F018A23B013
599	F017R2RD033	598	F017R3LD033	598	F017R4JD033	600	F017Z610000	193	F018A23B018
599	F017R2SA006	599	F017R3QA006	598	F017R4KA006	600	F017Z620000	193	F018A23B025
599	F017R2SA033	599	F017R3QA033	598	F017R4KA033	600	F017Z630000	193	F018A23B030
599	F017R2SB006	599	F017R3QB006	598	F017R4KB006	600	F017Z640000	193	F018A23B033
599	F017R2SB033	599	F017R3QB033	598	F017R4KB033	600	F017Z710000	193	F018A23D001
599	F017R2SD006	599	F017R3QD006	598	F017R4KD006	600	F017Z720000	193	F018A23D012
599	F017R2SD033	599	F017R3QD033	598	F017R4KD033	600	F017Z730000	193	F018A23D013
599	F017R2TA006	599	F017R3RA006	598	F017R4LA006	600	F017Z740000	193	F018A23D018
599	F017R2TA033	599	F017R3RA033	598	F017R4LA033	192	F018A21A001	193	F018A23D025
599	F017R2TB006	599	F017R3RB006	598	F017R4LB006	192	F018A21A012	193	F018A23D030
599	F017R2TB033	599	F017R3RB033	598	F017R4LB033	192	F018A21A013	193	F018A23D033
599	F017R2TD006	599	F017R3RD006	598	F017R4LD006	192	F018A21A018	192	F018A31A001
599	F017R2TD033	599	F017R3RD033	598	F017R4LD033	192	F018A21A025	192	F018A31A012
597	F017R3AA006	599	F017R3SA006	599	F017R4QA006	192	F018A21A030	192	F018A31A013
597	F017R3AA033	599	F017R3SA033	599	F017R4QA033	192	F018A21A033	192	F018A31A018
597	F017R3AB006	599	F017R3SB006	599	F017R4QB006	192	F018A21B001	192	F018A31A025
597	F017R3AB033	599	F017R3SB033	599	F017R4QB033	192	F018A21B012	192	F018A31A030
597	F017R3AD006	599	F017R3SD006	599	F017R4QD006	192	F018A21B013	192	F018A31A033
597	F017R3AD033	599	F017R3SD033	599	F017R4QD033	192	F018A21B018	192	F018A31B001
597	F017R3BA006	599	F017R3TA006	599	F017R4RA006	192	F018A21B025	192	F018A31B012
597	F017R3BA033	599	F017R3TA033	599	F017R4RA033	192	F018A21B030	192	F018A31B013
597	F017R3BB006	599	F017R3TB006	599	F017R4RB006	192	F018A21B033	192	F018A31B018
597	F017R3BB033	599	F017R3TB033	599	F017R4RB033	192	F018A21D001	192	F018A31B025
597	F017R3BD006	599	F017R3TD006	599	F017R4RD006	192	F018A21D012	192	F018A31B030
597	F017R3BD033	599	F017R3TD033	599	F017R4RD033	192	F018A21D013	192	F018A31B033
597	F017R3CA006	597	F017R4AA006	599	F017R4SA006	192	F018A21D018	192	F018A31D001
597	F017R3CA033	597	F017R4AA033	599	F017R4SA033	192	F018A21D025	192	F018A31D012
597	F017R3CB006	597	F017R4AB006	599	F017R4SB006	192	F018A21D030	192	F018A31D013
597	F017R3CB033	597	F017R4AB033	599	F017R4SB033	192	F018A21D033	192	F018A31D018
597	F017R3CD006	597	F017R4AD006	599	F017R4SD006	193	F018A22A001	192	F018A31D025
597	F017R3CD033	597	F017R4AD033	599	F017R4SD033	193	F018A22A012	192	F018A31D030
597	F017R3DA006	597	F017R4BA006	599	F017R4TA006	193	F018A22A013	192	F018A31D033
597	F017R3DA033	597	F017R4BA033	599	F017R4TA033	193	F018A22A018	193	F018A32A001
597	F017R3DB006	597	F017R4BB006	599	F017R4TB006	193	F018A22A025	193	F018A32A012
597	F017R3DB033	597	F017R4BB033	599	F017R4TB033	193	F018A22A030	193	F018A32A013
597	F017R3DD006	597	F017R4BD006	599	F017R4TD006	193	F018A22A033	193	F018A32A018
597	F017R3DD033	597	F017R4BD033	599	F017R4TD033	193	F018A22B001	193	F018A32A025
598	F017R3HA006	597	F017R4CA006	600	F017Z010000	193	F018A22B012	193	F018A32A030
598	F017R3HA033	597	F017R4CA033	600	F017Z020000	193	F018A22B013	193	F018A32A033
598	F017R3HB006	597	F017R4CB006	600	F017Z030000	193	F018A22B018	193	F018A32B001
598	F017R3HB033	597	F017R4CB033	600	F017Z040000	193	F018A22B025	193	F018A32B012
598	F017R3HD006	597	F017R4CD006	600	F017Z110000	193	F018A22B030	193	F018A32B013
598	F017R3HD033	597	F017R4CD033	600	F017Z120000	193	F018A22B033	193	F018A32B018

Page	Reference	Page	Reference	Page	Reference	Page	Reference	Page	Reference
193	F018A32B025	194	F018B32B012	195	F018D25A030	196	F018F21B013	196	F018F32A033
193	F018A32B030	194	F018B32B013	195	F018D25A033	196	F018F21B018	196	F018F32B001
193	F018A32B033	194	F018B32B018	195	F018D25B001	196	F018F21B025	196	F018F32B012
193	F018A32D001	194	F018B32B025	195	F018D25B012	196	F018F21B030	196	F018F32B013
193	F018A32D012	194	F018B32B030	195	F018D25B013	196	F018F21B033	196	F018F32B018
193	F018A32D013	194	F018B32B033	195	F018D25B018	196	F018F21D001	196	F018F32B025
193	F018A32D018	194	F018B32D001	195	F018D25B025	196	F018F21D012	196	F018F32B030
193	F018A32D025	194	F018B32D012	195	F018D25B030	196	F018F21D013	196	F018F32B033
193	F018A32D030	194	F018B32D013	195	F018D25B033	196	F018F21D018	196	F018F32D001
193	F018A32D033	194	F018B32D018	195	F018D25D001	196	F018F21D025	196	F018F32D012
193	F018A33A001	194	F018B32D025	195	F018D25D012	196	F018F21D030	196	F018F32D013
193	F018A33A012	194	F018B32D030	195	F018D25D013	196	F018F21D033	196	F018F32D018
193	F018A33A013	194	F018B32D033	195	F018D25D018	196	F018F22A001	196	F018F32D025
193	F018A33A018	194	F018C25A001	195	F018D25D025	196	F018F22A012	196	F018F32D030
193	F018A33A025	194	F018C25A012	195	F018D25D030	196	F018F22A013	196	F018F32D033
193	F018A33A030	194	F018C25A013	195	F018D25D033	196	F018F22A018	197	F018Z000000
193	F018A33A033	194	F018C25A018	195	F018D35A001	196	F018F22A025	280	F019A21D001
193	F018A33B001	194	F018C25A025	195	F018D35A012	196	F018F22A030	280	F019A21D006
193	F018A33B012	194	F018C25A030	195	F018D35A013	196	F018F22A033	280	F019A21D012
193	F018A33B013	194	F018C25A033	195	F018D35A018	196	F018F22B001	280	F019A21D018
193	F018A33B018	194	F018C25B001	195	F018D35A025	196	F018F22B012	280	F019A21D030
193	F018A33B025	194	F018C25B012	195	F018D35A030	196	F018F22B013	280	F019A21D033
193	F018A33B030	194	F018C25B013	195	F018D35A033	196	F018F22B018	280	F019A22D001
193	F018A33B033	194	F018C25B018	195	F018D35B001	196	F018F22B025	280	F019A22D006
193	F018A33D001	194	F018C25B025	195	F018D35B012	196	F018F22B030	280	F019A22D012
193	F018A33D012	194	F018C25B030	195	F018D35B013	196	F018F22B033	280	F019A22D018
193	F018A33D013	194	F018C25B033	195	F018D35B018	196	F018F22D001	280	F019A22D030
193	F018A33D018	194	F018C25D001	195	F018D35B025	196	F018F22D012	280	F019A22D033
193	F018A33D025	194	F018C25D012	195	F018D35B030	196	F018F22D013	282	F019A23D001
193	F018A33D030	194	F018C25D013	195	F018D35B033	196	F018F22D018	282	F019A23D006
193	F018A33D033	194	F018C25D018	195	F018D35D001	196	F018F22D025	282	F019A23D012
194	F018B22A001	194	F018C25D025	195	F018D35D012	196	F018F22D030	282	F019A23D018
194	F018B22A012	194	F018C25D030	195	F018D35D013	196	F018F22D033	282	F019A23D030
194	F018B22A013	194	F018C25D033	195	F018D35D018	196	F018F31A001	282	F019A23D033
194	F018B22A018	194	F018C35A001	195	F018D35D025	196	F018F31A012	280	F019A31D001
194	F018B22A025	194	F018C35A012	195	F018D35D030	196	F018F31A013	280	F019A31D006
194	F018B22A030	194	F018C35A013	195	F018D35D033	196	F018F31A018	280	F019A31D012
194	F018B22A033	194	F018C35A018	192	F018E21K001	196	F018F31A025	280	F019A31D018
194	F018B22B001	194	F018C35A025	192	F018E21K012	196	F018F31A030	280	F019A31D030
194	F018B22B012	194	F018C35A030	192	F018E21K013	196	F018F31A033	280	F019A31D033
194	F018B22B013	194	F018C35A033	192	F018E21K018	196	F018F31B001	280	F019A32D001
194	F018B22B018	194	F018C35B001	192	F018E21K025	196	F018F31B012	280	F019A32D006
194	F018B22B025	194	F018C35B012	192	F018E21K030	196	F018F31B013	280	F019A32D012
194	F018B22B030	194	F018C35B013	192	F018E21K033	196	F018F31B018	280	F019A32D018
194	F018B22B033	194	F018C35B018	192	F018E31K001	196	F018F31B025	280	F019A32D030
194	F018B22D001	194	F018C35B025	192	F018E31K012	196	F018F31B030	280	F019A32D033
194	F018B22D012	194	F018C35B030	192	F018E31K013	196	F018F31B033	282	F019A33D001
194	F018B22D013	194	F018C35B033	192	F018E31K018	196	F018F31D001	282	F019A33D006
194	F018B22D018	194	F018C35D001	192	F018E31K025	196	F018F31D012	282	F019A33D012
194	F018B22D025	194	F018C35D012	192	F018E31K030	196	F018F31D013	282	F019A33D018
194	F018B22D030	194	F018C35D013	192	F018E31K033	196	F018F31D018	282	F019A33D030
194	F018B22D033	194	F018C35D018	196	F018F21A001	196	F018F31D025	282	F019A33D033
194	F018B32A001	194	F018C35D025	196	F018F21A012	196	F018F31D030	280	F019A41D001
194	F018B32A012	194	F018C35D030	196	F018F21A013	196	F018F31D033	280	F019A41D006
194	F018B32A013	194	F018C35D033	196	F018F21A018	196	F018F32A001	280	F019A41D012
194	F018B32A018	195	F018D25A001	196	F018F21A025	196	F018F32A012	280	F019A41D018
194	F018B32A025	195	F018D25A012	196	F018F21A030	196	F018F32A013	280	F019A41D030
194	F018B32A030	195	F018D25A013	196	F018F21A033	196	F018F32A018	280	F019A41D033
194	F018B32A033	195	F018D25A018	196	F018F21B001	196	F018F32A025	280	F019A42D001
194	F018B32B001	195	F018D25A025	196	F018F21B012	196	F018F32A030	280	F019A42D006

Page	Reference	Page	Reference	Page	Reference	Page	Reference	Page	Reference
623	F020H2MH012	621	F020HTKH012	622	F020J4LH012	630	F021A16A012	635	F021A1HA012
623	F020H2MH018	621	F020HTKH018	622	F020J4LH018	630	F021A16A018	635	F021A1HA018
623	F020H2MH030	621	F020HTKH030	622	F020J4LH030	630	F021A16A030	635	F021A1HA030
623	F020H2MH033	621	F020HTKH033	622	F020J4LH033	630	F021A16A033	635	F021A1HA033
620	F020H3JH001	622	F020HTLH001	623	F020J4MH001	632	F021A17A001	629	F021A1JA001
620	F020H3JH006	622	F020HTLH006	623	F020J4MH006	632	F021A17A006	629	F021A1JA006
620	F020H3JH012	622	F020HTLH012	623	F020J4MH012	632	F021A17A012	629	F021A1JA012
620	F020H3JH018	622	F020HTLH018	623	F020J4MH018	632	F021A17A018	629	F021A1JA018
620	F020H3JH030	622	F020HTLH030	623	F020J4MH030	632	F021A17A030	629	F021A1JA030
620	F020H3JH033	622	F020HTLH033	623	F020J4MH033	632	F021A17A033	629	F021A1JA033
621	F020H3KH001	623	F020HTMH001	621	F020JTKH001	634	F021A18A001	631	F021A1KA001
621	F020H3KH006	623	F020HTMH006	621	F020JTKH006	634	F021A18A006	631	F021A1KA006
621	F020H3KH012	623	F020HTMH012	621	F020JTKH012	634	F021A18A012	631	F021A1KA012
621	F020H3KH018	623	F020HTMH018	621	F020JTKH018	634	F021A18A018	631	F021A1KA018
621	F020H3KH030	623	F020HTMH030	621	F020JTKH030	634	F021A18A030	631	F021A1KA030
621	F020H3KH033	623	F020HTMH033	621	F020JTKH033	634	F021A18A033	631	F021A1KA033
622	F020H3LH001	621	F020J2KH001	622	F020JTLH001	628	F021A1AA001	633	F021A1LA001
622	F020H3LH006	621	F020J2KH006	622	F020JTLH006	628	F021A1AA006	633	F021A1LA006
622	F020H3LH012	621	F020J2KH012	622	F020JTLH012	628	F021A1AA012	633	F021A1LA012
622	F020H3LH018	621	F020J2KH018	622	F020JTLH018	628	F021A1AA018	633	F021A1LA018
622	F020H3LH030	621	F020J2KH030	622	F020JTLH030	628	F021A1AA030	633	F021A1LA030
622	F020H3LH033	621	F020J2KH033	622	F020JTLH033	628	F021A1AA033	633	F021A1LA033
623	F020H3MH001	622	F020J2LH001	623	F020JTMH001	631	F021A1BA001	635	F021A1MA001
623	F020H3MH006	622	F020J2LH006	623	F020JTMH006	631	F021A1BA006	635	F021A1MA006
623	F020H3MH012	622	F020J2LH012	623	F020JTMH012	631	F021A1BA012	635	F021A1MA012
623	F020H3MH018	622	F020J2LH018	623	F020JTMH018	631	F021A1BA018	635	F021A1MA018
623	F020H3MH030	622	F020J2LH030	623	F020JTMH030	631	F021A1BA030	635	F021A1MA030
623	F020H3MH033	622	F020J2LH033	623	F020JTMH033	631	F021A1BA033	635	F021A1MA033
620	F020H4JH001	623	F020J2MH001	628	F021A11A001	633	F021A1CA001	628	F021A21A001
620	F020H4JH006	623	F020J2MH006	628	F021A11A006	633	F021A1CA006	628	F021A21A006
620	F020H4JH012	623	F020J2MH012	628	F021A11A012	633	F021A1CA012	628	F021A21A012
620	F020H4JH018	623	F020J2MH018	628	F021A11A018	633	F021A1CA018	628	F021A21A018
620	F020H4JH030	623	F020J2MH030	628	F021A11A030	633	F021A1CA030	628	F021A21A030
620	F020H4JH033	623	F020J2MH033	628	F021A11A033	633	F021A1CA033	628	F021A21A033
621	F020H4KH001	621	F020J3KH001	630	F021A12A001	635	F021A1DA001	630	F021A22A001
621	F020H4KH006	621	F020J3KH006	630	F021A12A006	635	F021A1DA006	630	F021A22A006
621	F020H4KH012	621	F020J3KH012	630	F021A12A012	635	F021A1DA012	630	F021A22A012
621	F020H4KH018	621	F020J3KH018	630	F021A12A018	635	F021A1DA018	630	F021A22A018
621	F020H4KH030	621	F020J3KH030	630	F021A12A030	635	F021A1DA030	630	F021A22A030
621	F020H4KH033	621	F020J3KH033	630	F021A12A033	635	F021A1DA033	630	F021A22A033
622	F020H4LH001	622	F020J3LH001	632	F021A13A001	629	F021A1EA001	632	F021A23A001
622	F020H4LH006	622	F020J3LH006	632	F021A13A006	629	F021A1EA006	632	F021A23A006
622	F020H4LH012	622	F020J3LH012	632	F021A13A012	629	F021A1EA012	632	F021A23A012
622	F020H4LH018	622	F020J3LH018	632	F021A13A018	629	F021A1EA018	632	F021A23A018
622	F020H4LH030	622	F020J3LH030	632	F021A13A030	629	F021A1EA030	632	F021A23A030
622	F020H4LH033	622	F020J3LH033	632	F021A13A033	629	F021A1EA033	632	F021A23A033
623	F020H4MH001	623	F020J3MH001	634	F021A14A001	631	F021A1FA001	634	F021A24A001
623	F020H4MH006	623	F020J3MH006	634	F021A14A006	631	F021A1FA006	634	F021A24A006
623	F020H4MH012	623	F020J3MH012	634	F021A14A012	631	F021A1FA012	634	F021A24A012
623	F020H4MH018	623	F020J3MH018	634	F021A14A018	631	F021A1FA018	634	F021A24A018
623	F020H4MH030	623	F020J3MH030	634	F021A14A030	631	F021A1FA030	634	F021A24A030
623	F020H4MH033	623	F020J3MH033	634	F021A14A033	631	F021A1FA033	634	F021A24A033
620	F020HTJH001	621	F020J4KH001	628	F021A15A001	633	F021A1GA001	628	F021A25A001
620	F020HTJH006	621	F020J4KH006	628	F021A15A006	633	F021A1GA006	628	F021A25A006
620	F020HTJH012	621	F020J4KH012	628	F021A15A012	633	F021A1GA012	628	F021A25A012
620	F020HTJH018	621	F020J4KH018	628	F021A15A018	633	F021A1GA018	628	F021A25A018
620	F020HTJH030	621	F020J4KH030	628	F021A15A030	633	F021A1GA030	628	F021A25A030
620	F020HTJH033	621	F020J4KH033	628	F021A15A033	633	F021A1GA033	628	F021A25A033
621	F020HTKH001	622	F020J4LH001	630	F021A16A001	635	F021A1HA001	630	F021A26A001
621	F020HTKH006	622	F020J4LH006	630	F021A16A006	635	F021A1HA006	630	F021A26A006

Page	Reference	Page	Reference	Page	Reference	Page	Reference	Page	Reference
635	F021A4HA012	634	F021B14A012	631	F021B1BA012	639	F021B1GD012	628	F021B21A012
635	F021A4HA018	634	F021B14A018	631	F021B1BA018	639	F021B1GD018	628	F021B21A018
635	F021A4HA030	634	F021B14A030	631	F021B1BA030	639	F021B1GD030	628	F021B21A030
635	F021A4HA033	634	F021B14A033	631	F021B1BA033	639	F021B1GD033	628	F021B21A033
629	F021A4JA001	640	F021B14D001	636	F021B1BD001	635	F021B1HA001	630	F021B22A001
629	F021A4JA006	640	F021B14D006	636	F021B1BD006	635	F021B1HA006	630	F021B22A006
629	F021A4JA012	640	F021B14D012	636	F021B1BD012	635	F021B1HA012	630	F021B22A012
629	F021A4JA018	640	F021B14D018	636	F021B1BD018	635	F021B1HA018	630	F021B22A018
629	F021A4JA030	640	F021B14D030	636	F021B1BD030	635	F021B1HA030	630	F021B22A030
629	F021A4JA033	640	F021B14D033	636	F021B1BD033	635	F021B1HA033	630	F021B22A033
631	F021A4KA001	628	F021B15A001	633	F021B1CA001	641	F021B1HD001	636	F021B22D001
631	F021A4KA006	628	F021B15A006	633	F021B1CA006	641	F021B1HD006	636	F021B22D006
631	F021A4KA012	628	F021B15A012	633	F021B1CA012	641	F021B1HD012	636	F021B22D012
631	F021A4KA018	628	F021B15A018	633	F021B1CA018	641	F021B1HD018	636	F021B22D018
631	F021A4KA030	628	F021B15A030	633	F021B1CA030	641	F021B1HD030	636	F021B22D030
631	F021A4KA033	628	F021B15A033	633	F021B1CA033	641	F021B1HD033	636	F021B22D033
633	F021A4LA001	630	F021B16A001	638	F021B1CD001	629	F021B1JA001	632	F021B23A001
633	F021A4LA006	630	F021B16A006	638	F021B1CD006	629	F021B1JA006	632	F021B23A006
633	F021A4LA012	630	F021B16A012	638	F021B1CD012	629	F021B1JA012	632	F021B23A012
633	F021A4LA018	630	F021B16A018	638	F021B1CD018	629	F021B1JA018	632	F021B23A018
633	F021A4LA030	630	F021B16A030	638	F021B1CD030	629	F021B1JA030	632	F021B23A030
633	F021A4LA033	630	F021B16A033	638	F021B1CD033	629	F021B1JA033	632	F021B23A033
635	F021A4MA001	636	F021B16D001	635	F021B1DA001	631	F021B1KA001	638	F021B23D001
635	F021A4MA006	636	F021B16D006	635	F021B1DA006	631	F021B1KA006	638	F021B23D006
635	F021A4MA012	636	F021B16D012	635	F021B1DA012	631	F021B1KA012	638	F021B23D012
635	F021A4MA018	636	F021B16D018	635	F021B1DA018	631	F021B1KA018	638	F021B23D018
635	F021A4MA030	636	F021B16D030	635	F021B1DA030	631	F021B1KA030	638	F021B23D030
635	F021A4MA033	636	F021B16D033	635	F021B1DA033	631	F021B1KA033	638	F021B23D033
628	F021B11A001	632	F021B17A001	640	F021B1DD001	637	F021B1KD001	634	F021B24A001
628	F021B11A006	632	F021B17A006	640	F021B1DD006	637	F021B1KD006	634	F021B24A006
628	F021B11A012	632	F021B17A012	640	F021B1DD012	637	F021B1KD012	634	F021B24A012
628	F021B11A018	632	F021B17A018	640	F021B1DD018	637	F021B1KD018	634	F021B24A018
628	F021B11A030	632	F021B17A030	640	F021B1DD030	637	F021B1KD030	634	F021B24A030
628	F021B11A033	632	F021B17A033	640	F021B1DD033	637	F021B1KD033	634	F021B24A033
630	F021B12A001	638	F021B17D001	629	F021B1EA001	633	F021B1LA001	640	F021B24D001
630	F021B12A006	638	F021B17D006	629	F021B1EA006	633	F021B1LA006	640	F021B24D006
630	F021B12A012	638	F021B17D012	629	F021B1EA012	633	F021B1LA012	640	F021B24D012
630	F021B12A018	638	F021B17D018	629	F021B1EA018	633	F021B1LA018	640	F021B24D018
630	F021B12A030	638	F021B17D030	629	F021B1EA030	633	F021B1LA030	640	F021B24D030
630	F021B12A033	638	F021B17D033	629	F021B1EA033	633	F021B1LA033	640	F021B24D033
636	F021B12D001	634	F021B18A001	631	F021B1FA001	639	F021B1LD001	628	F021B25A001
636	F021B12D006	634	F021B18A006	631	F021B1FA006	639	F021B1LD006	628	F021B25A006
636	F021B12D012	634	F021B18A012	631	F021B1FA012	639	F021B1LD012	628	F021B25A012
636	F021B12D018	634	F021B18A018	631	F021B1FA018	639	F021B1LD018	628	F021B25A018
636	F021B12D030	634	F021B18A030	631	F021B1FA030	639	F021B1LD030	628	F021B25A030
636	F021B12D033	634	F021B18A033	631	F021B1FA033	639	F021B1LD033	628	F021B25A033
632	F021B13A001	640	F021B18D001	637	F021B1FD001	635	F021B1MA001	630	F021B26A001
632	F021B13A006	640	F021B18D006	637	F021B1FD006	635	F021B1MA006	630	F021B26A006
632	F021B13A012	640	F021B18D012	637	F021B1FD012	635	F021B1MA012	630	F021B26A012
632	F021B13A018	640	F021B18D018	637	F021B1FD018	635	F021B1MA018	630	F021B26A018
632	F021B13A030	640	F021B18D030	637	F021B1FD030	635	F021B1MA030	630	F021B26A030
632	F021B13A033	640	F021B18D033	637	F021B1FD033	635	F021B1MA033	630	F021B26A033
638	F021B13D001	628	F021B1AA001	633	F021B1GA001	641	F021B1MD001	636	F021B26D001
638	F021B13D006	628	F021B1AA006	633	F021B1GA006	641	F021B1MD006	636	F021B26D006
638	F021B13D012	628	F021B1AA012	633	F021B1GA012	641	F021B1MD012	636	F021B26D012
638	F021B13D018	628	F021B1AA018	633	F021B1GA018	641	F021B1MD018	636	F021B26D018
638	F021B13D030	628	F021B1AA030	633	F021B1GA030	641	F021B1MD030	636	F021B26D030
638	F021B13D033	628	F021B1AA033	633	F021B1GA033	641	F021B1MD033	636	F021B26D033
634	F021B14A001	631	F021B1BA001	639	F021B1GD001	628	F021B21A001	632	F021B27A001
634	F021B14A006	631	F021B1BA006	639	F021B1GD006	628	F021B21A006	632	F021B27A006

Page	Reference	Page	Reference	Page	Reference	Page	Reference	Page	Reference
632	F021B27A012	640	F021B2DD012	637	F021B2KD012	634	F021B34A012	631	F021B3BA012
632	F021B27A018	640	F021B2DD018	637	F021B2KD018	634	F021B34A018	631	F021B3BA018
632	F021B27A030	640	F021B2DD030	637	F021B2KD030	634	F021B34A030	631	F021B3BA030
632	F021B27A033	640	F021B2DD033	637	F021B2KD033	634	F021B34A033	631	F021B3BA033
638	F021B27D001	629	F021B2EA001	633	F021B2LA001	640	F021B34D001	636	F021B3BD001
638	F021B27D006	629	F021B2EA006	633	F021B2LA006	640	F021B34D006	636	F021B3BD006
638	F021B27D012	629	F021B2EA012	633	F021B2LA012	640	F021B34D012	636	F021B3BD012
638	F021B27D018	629	F021B2EA018	633	F021B2LA018	640	F021B34D018	636	F021B3BD018
638	F021B27D030	629	F021B2EA030	633	F021B2LA030	640	F021B34D030	636	F021B3BD030
638	F021B27D033	629	F021B2EA033	633	F021B2LA033	640	F021B34D033	636	F021B3BD033
634	F021B28A001	631	F021B2FA001	639	F021B2LD001	628	F021B35A001	633	F021B3CA001
634	F021B28A006	631	F021B2FA006	639	F021B2LD006	628	F021B35A006	633	F021B3CA006
634	F021B28A012	631	F021B2FA012	639	F021B2LD012	628	F021B35A012	633	F021B3CA012
634	F021B28A018	631	F021B2FA018	639	F021B2LD018	628	F021B35A018	633	F021B3CA018
634	F021B28A030	631	F021B2FA030	639	F021B2LD030	628	F021B35A030	633	F021B3CA030
634	F021B28A033	631	F021B2FA033	639	F021B2LD033	628	F021B35A033	633	F021B3CA033
640	F021B28D001	637	F021B2FD001	635	F021B2MA001	630	F021B36A001	638	F021B3CD001
640	F021B28D006	637	F021B2FD006	635	F021B2MA006	630	F021B36A006	638	F021B3CD006
640	F021B28D012	637	F021B2FD012	635	F021B2MA012	630	F021B36A012	638	F021B3CD012
640	F021B28D018	637	F021B2FD018	635	F021B2MA018	630	F021B36A018	638	F021B3CD018
640	F021B28D030	637	F021B2FD030	635	F021B2MA030	630	F021B36A030	638	F021B3CD030
640	F021B28D033	637	F021B2FD033	635	F021B2MA033	630	F021B36A033	638	F021B3CD033
628	F021B2AA001	633	F021B2GA001	641	F021B2MD001	636	F021B36D001	635	F021B3DA001
628	F021B2AA006	633	F021B2GA006	641	F021B2MD006	636	F021B36D006	635	F021B3DA006
628	F021B2AA012	633	F021B2GA012	641	F021B2MD012	636	F021B36D012	635	F021B3DA012
628	F021B2AA018	633	F021B2GA018	641	F021B2MD018	636	F021B36D018	635	F021B3DA018
628	F021B2AA030	633	F021B2GA030	641	F021B2MD030	636	F021B36D030	635	F021B3DA030
628	F021B2AA033	633	F021B2GA033	641	F021B2MD033	636	F021B36D033	635	F021B3DA033
631	F021B2BA001	639	F021B2GD001	628	F021B31A001	632	F021B37A001	640	F021B3DD001
631	F021B2BA006	639	F021B2GD006	628	F021B31A006	632	F021B37A006	640	F021B3DD006
631	F021B2BA012	639	F021B2GD012	628	F021B31A012	632	F021B37A012	640	F021B3DD012
631	F021B2BA018	639	F021B2GD018	628	F021B31A018	632	F021B37A018	640	F021B3DD018
631	F021B2BA030	639	F021B2GD030	628	F021B31A030	632	F021B37A030	640	F021B3DD030
631	F021B2BA033	639	F021B2GD033	628	F021B31A033	632	F021B37A033	640	F021B3DD033
636	F021B2BD001	635	F021B2HA001	630	F021B32A001	638	F021B37D001	629	F021B3EA001
636	F021B2BD006	635	F021B2HA006	630	F021B32A006	638	F021B37D006	629	F021B3EA006
636	F021B2BD012	635	F021B2HA012	630	F021B32A012	638	F021B37D012	629	F021B3EA012
636	F021B2BD018	635	F021B2HA018	630	F021B32A018	638	F021B37D018	629	F021B3EA018
636	F021B2BD030	635	F021B2HA030	630	F021B32A030	638	F021B37D030	629	F021B3EA030
636	F021B2BD033	635	F021B2HA033	630	F021B32A033	638	F021B37D033	629	F021B3EA033
633	F021B2CA001	641	F021B2HD001	636	F021B32D001	634	F021B38A001	631	F021B3FA001
633	F021B2CA006	641	F021B2HD006	636	F021B32D006	634	F021B38A006	631	F021B3FA006
633	F021B2CA012	641	F021B2HD012	636	F021B32D012	634	F021B38A012	631	F021B3FA012
633	F021B2CA018	641	F021B2HD018	636	F021B32D018	634	F021B38A018	631	F021B3FA018
633	F021B2CA030	641	F021B2HD030	636	F021B32D030	634	F021B38A030	631	F021B3FA030
633	F021B2CA033	641	F021B2HD033	636	F021B32D033	634	F021B38A033	631	F021B3FA033
638	F021B2CD001	629	F021B2JA001	632	F021B33A001	640	F021B38D001	637	F021B3FD001
638	F021B2CD006	629	F021B2JA006	632	F021B33A006	640	F021B38D006	637	F021B3FD006
638	F021B2CD012	629	F021B2JA012	632	F021B33A012	640	F021B38D012	637	F021B3FD012
638	F021B2CD018	629	F021B2JA018	632	F021B33A018	640	F021B38D018	637	F021B3FD018
638	F021B2CD030	629	F021B2JA030	632	F021B33A030	640	F021B38D030	637	F021B3FD030
638	F021B2CD033	629	F021B2JA033	632	F021B33A033	640	F021B38D033	637	F021B3FD033
635	F021B2DA001	631	F021B2KA001	638	F021B33D001	628	F021B3AA001	633	F021B3GA001
635	F021B2DA006	631	F021B2KA006	638	F021B33D006	628	F021B3AA006	633	F021B3GA006
635	F021B2DA012	631	F021B2KA012	638	F021B33D012	628	F021B3AA012	633	F021B3GA012
635	F021B2DA018	631	F021B2KA018	638	F021B33D018	628	F021B3AA018	633	F021B3GA018
635	F021B2DA030	631	F021B2KA030	638	F021B33D030	628	F021B3AA030	633	F021B3GA030
635	F021B2DA033	631	F021B2KA033	638	F021B33D033	628	F021B3AA033	633	F021B3GA033
640	F021B2DD001	637	F021B2KD001	634	F021B34A001	631	F021B3BA001	639	F021B3GD001
640	F021B2DD006	637	F021B2KD006	634	F021B34A006	631	F021B3BA006	639	F021B3GD006

Page	Reference	Page	Reference	Page	Reference	Page	Reference	Page	Reference
639	F021B3GD012	628	F021B41A012	632	F021B47A012	640	F021B4DD012	637	F021B4KD012
639	F021B3GD018	628	F021B41A018	632	F021B47A018	640	F021B4DD018	637	F021B4KD018
639	F021B3GD030	628	F021B41A030	632	F021B47A030	640	F021B4DD030	637	F021B4KD030
639	F021B3GD033	628	F021B41A033	632	F021B47A033	640	F021B4DD033	637	F021B4KD033
635	F021B3HA001	630	F021B42A001	638	F021B47D001	629	F021B4EA001	633	F021B4LA001
635	F021B3HA006	630	F021B42A006	638	F021B47D006	629	F021B4EA006	633	F021B4LA006
635	F021B3HA012	630	F021B42A012	638	F021B47D012	629	F021B4EA012	633	F021B4LA012
635	F021B3HA018	630	F021B42A018	638	F021B47D018	629	F021B4EA018	633	F021B4LA018
635	F021B3HA030	630	F021B42A030	638	F021B47D030	629	F021B4EA030	633	F021B4LA030
635	F021B3HA033	630	F021B42A033	638	F021B47D033	629	F021B4EA033	633	F021B4LA033
641	F021B3HD001	636	F021B42D001	634	F021B48A001	631	F021B4FA001	639	F021B4LD001
641	F021B3HD006	636	F021B42D006	634	F021B48A006	631	F021B4FA006	639	F021B4LD006
641	F021B3HD012	636	F021B42D012	634	F021B48A012	631	F021B4FA012	639	F021B4LD012
641	F021B3HD018	636	F021B42D018	634	F021B48A018	631	F021B4FA018	639	F021B4LD018
641	F021B3HD030	636	F021B42D030	634	F021B48A030	631	F021B4FA030	639	F021B4LD030
641	F021B3HD033	636	F021B42D033	634	F021B48A033	631	F021B4FA033	639	F021B4LD033
629	F021B3JA001	632	F021B43A001	640	F021B48D001	637	F021B4FD001	635	F021B4MA001
629	F021B3JA006	632	F021B43A006	640	F021B48D006	637	F021B4FD006	635	F021B4MA006
629	F021B3JA012	632	F021B43A012	640	F021B48D012	637	F021B4FD012	635	F021B4MA012
629	F021B3JA018	632	F021B43A018	640	F021B48D018	637	F021B4FD018	635	F021B4MA018
629	F021B3JA030	632	F021B43A030	640	F021B48D030	637	F021B4FD030	635	F021B4MA030
629	F021B3JA033	632	F021B43A033	640	F021B48D033	637	F021B4FD033	635	F021B4MA033
631	F021B3KA001	638	F021B43D001	628	F021B44A001	633	F021B4GA001	641	F021B4MD001
631	F021B3KA006	638	F021B43D006	628	F021B44A006	633	F021B4GA006	641	F021B4MD006
631	F021B3KA012	638	F021B43D012	628	F021B44A012	633	F021B4GA012	641	F021B4MD012
631	F021B3KA018	638	F021B43D018	628	F021B44A018	633	F021B4GA018	641	F021B4MD018
631	F021B3KA030	638	F021B43D030	628	F021B44A030	633	F021B4GA030	641	F021B4MD030
631	F021B3KA033	638	F021B43D033	628	F021B44A033	633	F021B4GA033	641	F021B4MD033
637	F021B3KD001	634	F021B44A001	631	F021B4BA001	639	F021B4GD001	630	F021C12A001
637	F021B3KD006	634	F021B44A006	631	F021B4BA006	639	F021B4GD006	630	F021C12A006
637	F021B3KD012	634	F021B44A012	631	F021B4BA012	639	F021B4GD012	630	F021C12A012
637	F021B3KD018	634	F021B44A018	631	F021B4BA018	639	F021B4GD018	630	F021C12A018
637	F021B3KD030	634	F021B44A030	631	F021B4BA030	639	F021B4GD030	630	F021C12A030
637	F021B3KD033	634	F021B44A033	631	F021B4BA033	639	F021B4GD033	630	F021C12A033
633	F021B3LA001	640	F021B44D001	636	F021B4BD001	635	F021B4HA001	636	F021C12D001
633	F021B3LA006	640	F021B44D006	636	F021B4BD006	635	F021B4HA006	636	F021C12D006
633	F021B3LA012	640	F021B44D012	636	F021B4BD012	635	F021B4HA012	636	F021C12D012
633	F021B3LA018	640	F021B44D018	636	F021B4BD018	635	F021B4HA018	636	F021C12D018
633	F021B3LA030	640	F021B44D030	636	F021B4BD030	635	F021B4HA030	636	F021C12D030
633	F021B3LA033	640	F021B44D033	636	F021B4BD033	635	F021B4HA033	636	F021C12D033
639	F021B3LD001	628	F021B45A001	633	F021B4CA001	641	F021B4HD001	632	F021C13A001
639	F021B3LD006	628	F021B45A006	633	F021B4CA006	641	F021B4HD006	632	F021C13A006
639	F021B3LD012	628	F021B45A012	633	F021B4CA012	641	F021B4HD012	632	F021C13A012
639	F021B3LD018	628	F021B45A018	633	F021B4CA018	641	F021B4HD018	632	F021C13A018
639	F021B3LD030	628	F021B45A030	633	F021B4CA030	641	F021B4HD030	632	F021C13A030
639	F021B3LD033	628	F021B45A033	633	F021B4CA033	641	F021B4HD033	632	F021C13A033
635	F021B3MA001	630	F021B46A001	638	F021B4CD001	629	F021B4JA001	638	F021C13D001
635	F021B3MA006	630	F021B46A006	638	F021B4CD006	629	F021B4JA006	638	F021C13D006
635	F021B3MA012	630	F021B46A012	638	F021B4CD012	629	F021B4JA012	638	F021C13D012
635	F021B3MA018	630	F021B46A018	638	F021B4CD018	629	F021B4JA018	638	F021C13D018
635	F021B3MA030	630	F021B46A030	638	F021B4CD030	629	F021B4JA030	638	F021C13D030
635	F021B3MA033	630	F021B46A033	638	F021B4CD033	629	F021B4JA033	638	F021C13D033
641	F021B3MD001	636	F021B46D001	635	F021B4DA001	631	F021B4KA001	634	F021C14A001
641	F021B3MD006	636	F021B46D006	635	F021B4DA006	631	F021B4KA006	634	F021C14A006
641	F021B3MD012	636	F021B46D012	635	F021B4DA012	631	F021B4KA012	634	F021C14A012
641	F021B3MD018	636	F021B46D018	635	F021B4DA018	631	F021B4KA018	634	F021C14A018
641	F021B3MD030	636	F021B46D030	635	F021B4DA030	631	F021B4KA030	634	F021C14A030
641	F021B3MD033	636	F021B46D033	635	F021B4DA033	631	F021B4KA033	634	F021C14A033
628	F021B41A001	632	F021B47A001	640	F021B4DD001	637	F021B4KD001	640	F021C14D001
628	F021B41A006	632	F021B47A006	640	F021B4DD006	637	F021B4KD006	640	F021C14D006

Page	Reference	Page	Reference	Page	Reference	Page	Reference	Page	Reference
638	F021C4CD012	637	F021C4KD012	645	F021G2MA012	644	F021G4KA012	644	F021H3JA012
638	F021C4CD018	637	F021C4KD018	645	F021G2MA018	644	F021G4KA018	644	F021H3JA018
638	F021C4CD030	637	F021C4KD030	645	F021G2MA030	644	F021G4KA030	644	F021H3JA030
638	F021C4CD033	637	F021C4KD033	645	F021G2MA033	644	F021G4KA033	644	F021H3JA033
635	F021C4DA001	633	F021C4LA001	647	F021G2MD001	646	F021G4KD001	644	F021H3KA001
635	F021C4DA006	633	F021C4LA006	647	F021G2MD006	646	F021G4KD006	644	F021H3KA006
635	F021C4DA012	633	F021C4LA012	647	F021G2MD012	646	F021G4KD012	644	F021H3KA012
635	F021C4DA018	633	F021C4LA018	647	F021G2MD018	646	F021G4KD018	644	F021H3KA018
635	F021C4DA030	633	F021C4LA030	647	F021G2MD030	646	F021G4KD030	644	F021H3KA030
635	F021C4DA033	633	F021C4LA033	647	F021G2MD033	646	F021G4KD033	644	F021H3KA033
640	F021C4DD001	639	F021C4LD001	644	F021G3JA001	645	F021G4LA001	645	F021H3LA001
640	F021C4DD006	639	F021C4LD006	644	F021G3JA006	645	F021G4LA006	645	F021H3LA006
640	F021C4DD012	639	F021C4LD012	644	F021G3JA012	645	F021G4LA012	645	F021H3LA012
640	F021C4DD018	639	F021C4LD018	644	F021G3JA018	645	F021G4LA018	645	F021H3LA018
640	F021C4DD030	639	F021C4LD030	644	F021G3JA030	645	F021G4LA030	645	F021H3LA030
640	F021C4DD033	639	F021C4LD033	644	F021G3JA033	645	F021G4LA033	645	F021H3LA033
631	F021C4FA001	635	F021C4MA001	644	F021G3KA001	646	F021G4LD001	645	F021H3MA001
631	F021C4FA006	635	F021C4MA006	644	F021G3KA006	646	F021G4LD006	645	F021H3MA006
631	F021C4FA012	635	F021C4MA012	644	F021G3KA012	646	F021G4LD012	645	F021H3MA012
631	F021C4FA018	635	F021C4MA018	644	F021G3KA018	646	F021G4LD018	645	F021H3MA018
631	F021C4FA030	635	F021C4MA030	644	F021G3KA030	646	F021G4LD030	645	F021H3MA030
631	F021C4FA033	635	F021C4MA033	644	F021G3KA033	646	F021G4LD033	645	F021H3MA033
637	F021C4FD001	641	F021C4MD001	646	F021G3KD001	645	F021G4MA001	644	F021H4JA001
637	F021C4FD006	641	F021C4MD006	646	F021G3KD006	645	F021G4MA006	644	F021H4JA006
637	F021C4FD012	641	F021C4MD012	646	F021G3KD012	645	F021G4MA012	644	F021H4JA012
637	F021C4FD018	641	F021C4MD018	646	F021G3KD018	645	F021G4MA018	644	F021H4JA018
637	F021C4FD030	641	F021C4MD030	646	F021G3KD030	645	F021G4MA030	644	F021H4JA030
637	F021C4FD033	641	F021C4MD033	646	F021G3KD033	645	F021G4MA033	644	F021H4JA033
633	F021C4GA001	644	F021G2JA001	645	F021G3LA001	647	F021G4MD001	644	F021H4KA001
633	F021C4GA006	644	F021G2JA006	645	F021G3LA006	647	F021G4MD006	644	F021H4KA006
633	F021C4GA012	644	F021G2JA012	645	F021G3LA012	647	F021G4MD012	644	F021H4KA012
633	F021C4GA018	644	F021G2JA018	645	F021G3LA018	647	F021G4MD018	644	F021H4KA018
633	F021C4GA030	644	F021G2JA030	645	F021G3LA030	647	F021G4MD030	644	F021H4KA030
633	F021C4GA033	644	F021G2JA033	645	F021G3LA033	647	F021G4MD033	644	F021H4KA033
639	F021C4GD001	644	F021G2KA001	646	F021G3LD001	644	F021H2JA001	645	F021H4LA001
639	F021C4GD006	644	F021G2KA006	646	F021G3LD006	644	F021H2JA006	645	F021H4LA006
639	F021C4GD012	644	F021G2KA012	646	F021G3LD012	644	F021H2JA012	645	F021H4LA012
639	F021C4GD018	644	F021G2KA018	646	F021G3LD018	644	F021H2JA018	645	F021H4LA018
639	F021C4GD030	644	F021G2KA030	646	F021G3LD030	644	F021H2JA030	645	F021H4LA030
639	F021C4GD033	644	F021G2KA033	646	F021G3LD033	644	F021H2JA033	645	F021H4LA033
635	F021C4HA001	646	F021G2KD001	645	F021G3MA001	644	F021H2KA001	645	F021H4MA001
635	F021C4HA006	646	F021G2KD006	645	F021G3MA006	644	F021H2KA006	645	F021H4MA006
635	F021C4HA012	646	F021G2KD012	645	F021G3MA012	644	F021H2KA012	645	F021H4MA012
635	F021C4HA018	646	F021G2KD018	645	F021G3MA018	644	F021H2KA018	645	F021H4MA018
635	F021C4HA030	646	F021G2KD030	645	F021G3MA030	644	F021H2KA030	645	F021H4MA030
635	F021C4HA033	646	F021G2KD033	645	F021G3MA033	644	F021H2KA033	645	F021H4MA033
641	F021C4HD001	645	F021G2LA001	647	F021G3MD001	645	F021H2LA001	644	F021J2KA001
641	F021C4HD006	645	F021G2LA006	647	F021G3MD006	645	F021H2LA006	644	F021J2KA006
641	F021C4HD012	645	F021G2LA012	647	F021G3MD012	645	F021H2LA012	644	F021J2KA012
641	F021C4HD018	645	F021G2LA018	647	F021G3MD018	645	F021H2LA018	644	F021J2KA018
641	F021C4HD030	645	F021G2LA030	647	F021G3MD030	645	F021H2LA030	644	F021J2KA030
641	F021C4HD033	645	F021G2LA033	647	F021G3MD033	645	F021H2LA033	644	F021J2KA033
631	F021C4KA001	646	F021G2LD001	644	F021G4JA001	645	F021H2MA001	646	F021J2KD001
631	F021C4KA006	646	F021G2LD006	644	F021G4JA006	645	F021H2MA006	646	F021J2KD006
631	F021C4KA012	646	F021G2LD012	644	F021G4JA012	645	F021H2MA012	646	F021J2KD012
631	F021C4KA018	646	F021G2LD018	644	F021G4JA018	645	F021H2MA018	646	F021J2KD018
631	F021C4KA030	646	F021G2LD030	644	F021G4JA030	645	F021H2MA030	646	F021J2KD030
631	F021C4KA033	646	F021G2LD033	644	F021G4JA033	645	F021H2MA033	646	F021J2KD033
637	F021C4KD001	645	F021G2MA001	644	F021G4KA001	644	F021H3JA001	645	F021J2LA001
637	F021C4KD006	645	F021G2MA006	644	F021G4KA006	644	F021H3JA006	645	F021J2LA006

Page	Reference	Page	Reference	Page	Reference	Page	Reference	Page	Reference
645	F021J2LA012	644	F021J4KA012	648	F021LTKD012	643	F021PTLD012	170	F023B2BA033
645	F021J2LA018	644	F021J4KA018	648	F021LTKD018	643	F021PTLD018	170	F023B2BB001
645	F021J2LA030	644	F021J4KA030	648	F021LTKD030	643	F021PTLD030	170	F023B2BB006
645	F021J2LA033	644	F021J4KA033	648	F021LTKD033	643	F021PTLD033	170	F023B2BB012
646	F021J2LD001	646	F021J4KD001	648	F021LTLD001	643	F021PTMD001	170	F023B2BB018
646	F021J2LD006	646	F021J4KD006	648	F021LTLD006	643	F021PTMD006	170	F023B2BB030
646	F021J2LD012	646	F021J4KD012	648	F021LTLD012	643	F021PTMD012	170	F023B2BB033
646	F021J2LD018	646	F021J4KD018	648	F021LTLD018	643	F021PTMD018	170	F023B2BD001
646	F021J2LD030	646	F021J4KD030	648	F021LTLD030	643	F021PTMD030	170	F023B2BD006
646	F021J2LD033	646	F021J4KD033	648	F021LTLD033	643	F021PTMD033	170	F023B2BD012
645	F021J2MA001	645	F021J4LA001	648	F021LTMD001	643	F021QTKD001	170	F023B2BD018
645	F021J2MA006	645	F021J4LA006	648	F021LTMD006	643	F021QTKD006	170	F023B2BD030
645	F021J2MA012	645	F021J4LA012	648	F021LTMD012	643	F021QTKD012	170	F023B2BD033
645	F021J2MA018	645	F021J4LA018	648	F021LTMD018	643	F021QTKD018	170	F023B3AA001
645	F021J2MA030	645	F021J4LA030	648	F021LTMD030	643	F021QTKD030	170	F023B3AA006
645	F021J2MA033	645	F021J4LA033	648	F021LTMD033	643	F021QTKD033	170	F023B3AA012
647	F021J2MD001	646	F021J4LD001	642	F021MRKJ001	643	F021QTL001	170	F023B3AA018
647	F021J2MD006	646	F021J4LD006	642	F021MRKJ006	643	F021QTL006	170	F023B3AA030
647	F021J2MD012	646	F021J4LD012	642	F021MRKJ012	643	F021QTL012	170	F023B3AA033
647	F021J2MD018	646	F021J4LD018	642	F021MRKJ018	643	F021QTL018	170	F023B3AB001
647	F021J2MD030	646	F021J4LD030	642	F021MRKJ030	643	F021QTL030	170	F023B3AB006
647	F021J2MD033	646	F021J4LD033	642	F021MRKJ033	643	F021QTL033	170	F023B3AB012
644	F021J3KA001	645	F021J4MA001	642	F021MRLJ001	643	F021QTMD001	170	F023B3AB018
644	F021J3KA006	645	F021J4MA006	642	F021MRLJ006	643	F021QTMD006	170	F023B3AB030
644	F021J3KA012	645	F021J4MA012	642	F021MRLJ012	643	F021QTMD012	170	F023B3AB033
644	F021J3KA018	645	F021J4MA018	642	F021MRLJ018	643	F021QTMD018	170	F023B3AD001
644	F021J3KA030	645	F021J4MA030	642	F021MRLJ030	643	F021QTMD030	170	F023B3AD006
644	F021J3KA033	645	F021J4MA033	642	F021MRLJ033	643	F021QTMD033	170	F023B3AD012
646	F021J3KD001	647	F021J4MD001	642	F021MRMJ001	624	F021Z010000	170	F023B3AD018
646	F021J3KD006	647	F021J4MD006	642	F021MRMJ006	649	F021Z020000	170	F023B3AD030
646	F021J3KD012	647	F021J4MD012	642	F021MRMJ012	649	F021Z030000	170	F023B3AD033
646	F021J3KD018	647	F021J4MD018	642	F021MRMJ018	650	F021Z040000	170	F023B3BA001
646	F021J3KD030	647	F021J4MD030	642	F021MRMJ030	650	F021Z050000	170	F023B3BA006
646	F021J3KD033	647	F021J4MD033	642	F021MRMJ033	650	F021Z060000	170	F023B3BA012
645	F021J3LA001	648	F021KTJD001	642	F021MWKJ001	624	F021Z070000	170	F023B3BA018
645	F021J3LA006	648	F021KTJD006	642	F021MWKJ006	624	F021Z090000	170	F023B3BA030
645	F021J3LA012	648	F021KTJD012	642	F021MWKJ012	624	F021Z100000	170	F023B3BA033
645	F021J3LA018	648	F021KTJD018	642	F021MWKJ018	170	F023B2AA001	170	F023B3BB001
645	F021J3LA030	648	F021KTJD030	642	F021MWKJ030	170	F023B2AA006	170	F023B3BB006
645	F021J3LA033	648	F021KTJD033	642	F021MWKJ033	170	F023B2AA012	170	F023B3BB012
646	F021J3LD001	648	F021KTKD001	642	F021MWLJ001	170	F023B2AA018	170	F023B3BB018
646	F021J3LD006	648	F021KTKD006	642	F021MWLJ006	170	F023B2AA030	170	F023B3BB030
646	F021J3LD012	648	F021KTKD012	642	F021MWLJ012	170	F023B2AA033	170	F023B3BB033
646	F021J3LD018	648	F021KTKD018	642	F021MWLJ018	170	F023B2AB001	170	F023B3BD001
646	F021J3LD030	648	F021KTKD030	642	F021MWLJ030	170	F023B2AB006	170	F023B3BD006
646	F021J3LD033	648	F021KTKD033	642	F021MWLJ033	170	F023B2AB012	170	F023B3BD012
645	F021J3MA001	648	F021KTLD001	642	F021MWMJ001	170	F023B2AB018	170	F023B3BD018
645	F021J3MA006	648	F021KTLD006	642	F021MWMJ006	170	F023B2AB030	170	F023B3BD030
645	F021J3MA012	648	F021KTLD012	642	F021MWMJ012	170	F023B2AB033	170	F023B3BD033
645	F021J3MA018	648	F021KTLD018	642	F021MWMJ018	170	F023B2AD001	170	F023B4AA001
645	F021J3MA030	648	F021KTLD030	642	F021MWMJ030	170	F023B2AD006	170	F023B4AA006
645	F021J3MA033	648	F021KTLD033	642	F021MWMJ033	170	F023B2AD012	170	F023B4AA012
647	F021J3MD001	648	F021KTMD001	643	F021PTKD001	170	F023B2AD018	170	F023B4AA018
647	F021J3MD006	648	F021KTMD006	643	F021PTKD006	170	F023B2AD030	170	F023B4AA030
647	F021J3MD012	648	F021KTMD012	643	F021PTKD012	170	F023B2AD033	170	F023B4AA033
647	F021J3MD018	648	F021KTMD018	643	F021PTKD018	170	F023B2BA001	170	F023B4AB001
647	F021J3MD030	648	F021KTMD030	643	F021PTKD030	170	F023B2BA006	170	F023B4AB006
647	F021J3MD033	648	F021KTMD033	643	F021PTKD033	170	F023B2BA012	170	F023B4AB012
644	F021J4KA001	648	F021LTKD001	643	F021PTLD001	170	F023B2BA018	170	F023B4AB018
644	F021J4KA006	648	F021LTKD006	643	F021PTLD006	170	F023B2BA030	170	F023B4AB030

Page	Reference	Page	Reference	Page	Reference	Page	Reference	Page	Reference
170	F023B4AB033	171	F023C2DD033	171	F023C4DA033	165	F023E2CB033	165	F023E3CD033
170	F023B4AD001	171	F023C3CA001	171	F023C4DB001	165	F023E2CD001	164	F023E4AA001
170	F023B4AD006	171	F023C3CA006	171	F023C4DB006	165	F023E2CD006	164	F023E4AA006
170	F023B4AD012	171	F023C3CA012	171	F023C4DB012	165	F023E2CD012	164	F023E4AA012
170	F023B4AD018	171	F023C3CA018	171	F023C4DB018	165	F023E2CD018	164	F023E4AA018
170	F023B4AD030	171	F023C3CA030	171	F023C4DB030	165	F023E2CD030	164	F023E4AA030
170	F023B4AD033	171	F023C3CA033	171	F023C4DB033	165	F023E2CD033	164	F023E4AA033
170	F023B4BA001	171	F023C3CB001	171	F023C4DD001	164	F023E3AA001	164	F023E4AB001
170	F023B4BA006	171	F023C3CB006	171	F023C4DD006	164	F023E3AA006	164	F023E4AB006
170	F023B4BA012	171	F023C3CB012	171	F023C4DD012	164	F023E3AA012	164	F023E4AB012
170	F023B4BA018	171	F023C3CB018	171	F023C4DD018	164	F023E3AA018	164	F023E4AB018
170	F023B4BA030	171	F023C3CB030	171	F023C4DD030	164	F023E3AA030	164	F023E4AB030
170	F023B4BA033	171	F023C3CB033	171	F023C4DD033	164	F023E3AA033	164	F023E4AB033
170	F023B4BB001	171	F023C3CD001	164	F023E2AA001	164	F023E3AB001	164	F023E4AD001
170	F023B4BB006	171	F023C3CD006	164	F023E2AA006	164	F023E3AB006	164	F023E4AD006
170	F023B4BB012	171	F023C3CD012	164	F023E2AA012	164	F023E3AB012	164	F023E4AD012
170	F023B4BB018	171	F023C3CD018	164	F023E2AA018	164	F023E3AB018	164	F023E4AD018
170	F023B4BB030	171	F023C3CD030	164	F023E2AA030	164	F023E3AB030	164	F023E4AD030
170	F023B4BB033	171	F023C3CD033	164	F023E2AA033	164	F023E3AB033	164	F023E4AD033
170	F023B4BD001	171	F023C3DA001	164	F023E2AB001	164	F023E3AD001	164	F023E4BA001
170	F023B4BD006	171	F023C3DA006	164	F023E2AB006	164	F023E3AD006	164	F023E4BA006
170	F023B4BD012	171	F023C3DA012	164	F023E2AB012	164	F023E3AD012	164	F023E4BA012
170	F023B4BD018	171	F023C3DA018	164	F023E2AB018	164	F023E3AD018	164	F023E4BA018
170	F023B4BD030	171	F023C3DA030	164	F023E2AB030	164	F023E3AD030	164	F023E4BA030
170	F023B4BD033	171	F023C3DA033	164	F023E2AB033	164	F023E3AD033	164	F023E4BA033
171	F023C2CA001	171	F023C3DB001	164	F023E2AD001	164	F023E3BA001	164	F023E4BB001
171	F023C2CA006	171	F023C3DB006	164	F023E2AD006	164	F023E3BA006	164	F023E4BB006
171	F023C2CA012	171	F023C3DB012	164	F023E2AD012	164	F023E3BA012	164	F023E4BB012
171	F023C2CA018	171	F023C3DB018	164	F023E2AD018	164	F023E3BA018	164	F023E4BB018
171	F023C2CA030	171	F023C3DB030	164	F023E2AD030	164	F023E3BA030	164	F023E4BB030
171	F023C2CA033	171	F023C3DB033	164	F023E2AD033	164	F023E3BA033	164	F023E4BB033
171	F023C2CB001	171	F023C3DD001	164	F023E2BA001	164	F023E3BB001	164	F023E4BD001
171	F023C2CB006	171	F023C3DD006	164	F023E2BA006	164	F023E3BB006	164	F023E4BD006
171	F023C2CB012	171	F023C3DD012	164	F023E2BA012	164	F023E3BB012	164	F023E4BD012
171	F023C2CB018	171	F023C3DD018	164	F023E2BA018	164	F023E3BB018	164	F023E4BD018
171	F023C2CB030	171	F023C3DD030	164	F023E2BA030	164	F023E3BB030	164	F023E4BD030
171	F023C2CB033	171	F023C3DD033	164	F023E2BA033	164	F023E3BB033	164	F023E4BD033
171	F023C2CD001	171	F023C4CA001	164	F023E2BB001	164	F023E3BD001	165	F023E4CA001
171	F023C2CD006	171	F023C4CA006	164	F023E2BB006	164	F023E3BD006	165	F023E4CA006
171	F023C2CD012	171	F023C4CA012	164	F023E2BB012	164	F023E3BD012	165	F023E4CA012
171	F023C2CD018	171	F023C4CA018	164	F023E2BB018	164	F023E3BD018	165	F023E4CA018
171	F023C2CD030	171	F023C4CA030	164	F023E2BB030	164	F023E3BD030	165	F023E4CA030
171	F023C2CD033	171	F023C4CA033	164	F023E2BB033	164	F023E3BD033	165	F023E4CA033
171	F023C2DA001	171	F023C4CB001	164	F023E2BD001	165	F023E3CA001	165	F023E4CB001
171	F023C2DA006	171	F023C4CB006	164	F023E2BD006	165	F023E3CA006	165	F023E4CB006
171	F023C2DA012	171	F023C4CB012	164	F023E2BD012	165	F023E3CA012	165	F023E4CB012
171	F023C2DA018	171	F023C4CB018	164	F023E2BD018	165	F023E3CA018	165	F023E4CB018
171	F023C2DA030	171	F023C4CB030	164	F023E2BD030	165	F023E3CA030	165	F023E4CB030
171	F023C2DA033	171	F023C4CB033	164	F023E2BD033	165	F023E3CA033	165	F023E4CB033
171	F023C2DB001	171	F023C4CD001	165	F023E2CA001	165	F023E3CB001	165	F023E4CD001
171	F023C2DB006	171	F023C4CD006	165	F023E2CA006	165	F023E3CB006	165	F023E4CD006
171	F023C2DB012	171	F023C4CD012	165	F023E2CA012	165	F023E3CB012	165	F023E4CD012
171	F023C2DB018	171	F023C4CD018	165	F023E2CA018	165	F023E3CB018	165	F023E4CD018
171	F023C2DB030	171	F023C4CD030	165	F023E2CA030	165	F023E3CB030	165	F023E4CD030
171	F023C2DB033	171	F023C4CD033	165	F023E2CA033	165	F023E3CB033	165	F023E4CD033
171	F023C2DD001	171	F023C4DA001	165	F023E2CB001	165	F023E3CD001	167	F023F2AA001
171	F023C2DD006	171	F023C4DA006	165	F023E2CB006	165	F023E3CD006	167	F023F2AA006
171	F023C2DD012	171	F023C4DA012	165	F023E2CB012	165	F023E3CD012	167	F023F2AA012
171	F023C2DD018	171	F023C4DA018	165	F023E2CB018	165	F023E3CD018	167	F023F2AA018
171	F023C2DD030	171	F023C4DA030	165	F023E2CB030	165	F023E3CD030	167	F023F2AA030

Page	Reference	Page	Reference	Page	Reference	Page	Reference	Page	Reference
182	F023K41A033	183	F023L42A033	185	F023M23D033	184	F023M41A033	130	F02502CA001
182	F023K42A001	183	F023L43A001	184	F023M31A001	184	F023M41B001	130	F02502CA006
182	F023K42A006	183	F023L43A006	184	F023M31A006	184	F023M41B006	130	F02502CA012
182	F023K42A012	183	F023L43A012	184	F023M31A012	184	F023M41B012	130	F02502CA018
182	F023K42A018	183	F023L43A018	184	F023M31A018	184	F023M41B018	130	F02502CA030
182	F023K42A030	183	F023L43A030	184	F023M31A030	184	F023M41B030	130	F02502CA033
182	F023K42A033	183	F023L43A033	184	F023M31A033	184	F023M41B033	130	F02503BA001
182	F023K43A001	184	F023M21A001	184	F023M31B001	184	F023M41D001	130	F02503BA006
182	F023K43A006	184	F023M21A006	184	F023M31B006	184	F023M41D006	130	F02503BA012
182	F023K43A012	184	F023M21A012	184	F023M31B012	184	F023M41D012	130	F02503BA018
182	F023K43A018	184	F023M21A018	184	F023M31B018	184	F023M41D018	130	F02503BA030
182	F023K43A030	184	F023M21A030	184	F023M31B030	184	F023M41D030	130	F02503BA033
182	F023K43A033	184	F023M21A033	184	F023M31B033	184	F023M41D033	130	F02503CA001
183	F023L21A001	184	F023M21B001	184	F023M31D001	184	F023M42A001	130	F02503CA006
183	F023L21A006	184	F023M21B006	184	F023M31D006	184	F023M42A006	130	F02503CA012
183	F023L21A012	184	F023M21B012	184	F023M31D012	184	F023M42A012	130	F02503CA018
183	F023L21A018	184	F023M21B018	184	F023M31D018	184	F023M42A018	130	F02503CA030
183	F023L21A030	184	F023M21B030	184	F023M31D030	184	F023M42A030	130	F02503CA033
183	F023L21A033	184	F023M21B033	184	F023M31D033	184	F023M42A033	130	F02504BA001
183	F023L22A001	184	F023M21D001	184	F023M32A001	184	F023M42B001	130	F02504BA006
183	F023L22A006	184	F023M21D006	184	F023M32A006	184	F023M42B006	130	F02504BA012
183	F023L22A012	184	F023M21D012	184	F023M32A012	184	F023M42B012	130	F02504BA018
183	F023L22A018	184	F023M21D018	184	F023M32A018	184	F023M42B018	130	F02504BA030
183	F023L22A030	184	F023M21D030	184	F023M32A030	184	F023M42B030	130	F02504BA033
183	F023L22A033	184	F023M21D033	184	F023M32A033	184	F023M42B033	130	F02504CA001
183	F023L23A001	184	F023M22A001	184	F023M32B001	184	F023M42D001	130	F02504CA006
183	F023L23A006	184	F023M22A006	184	F023M32B006	184	F023M42D006	130	F02504CA012
183	F023L23A012	184	F023M22A012	184	F023M32B012	184	F023M42D012	130	F02504CA018
183	F023L23A018	184	F023M22A018	184	F023M32B018	184	F023M42D018	130	F02504CA030
183	F023L23A030	184	F023M22A030	184	F023M32B030	184	F023M42D030	130	F02504CA033
183	F023L23A033	184	F023M22A033	184	F023M32B033	184	F023M42D033	144	F02512AA001
183	F023L31A001	184	F023M22B001	184	F023M32D001	185	F023M43A001	144	F02512AA006
183	F023L31A006	184	F023M22B006	184	F023M32D006	185	F023M43A006	144	F02512AA012
183	F023L31A012	184	F023M22B012	184	F023M32D012	185	F023M43A012	144	F02512AA018
183	F023L31A018	184	F023M22B018	184	F023M32D018	185	F023M43A018	144	F02512AA030
183	F023L31A030	184	F023M22B030	184	F023M32D030	185	F023M43A030	144	F02512AA033
183	F023L31A033	184	F023M22B033	184	F023M32D033	185	F023M43A033	144	F02512BA001
183	F023L32A001	184	F023M22D001	185	F023M33A001	185	F023M43B001	144	F02512BA006
183	F023L32A006	184	F023M22D006	185	F023M33A006	185	F023M43B006	144	F02512BA012
183	F023L32A012	184	F023M22D012	185	F023M33A012	185	F023M43B012	144	F02512BA018
183	F023L32A018	184	F023M22D018	185	F023M33A018	185	F023M43B018	144	F02512BA030
183	F023L32A030	184	F023M22D030	185	F023M33A030	185	F023M43B030	144	F02512BA033
183	F023L32A033	184	F023M22D033	185	F023M33A033	185	F023M43B033	144	F02512CA001
183	F023L33A001	185	F023M23A001	185	F023M33B001	185	F023M43D001	144	F02512CA006
183	F023L33A006	185	F023M23A006	185	F023M33B006	185	F023M43D006	144	F02512CA012
183	F023L33A012	185	F023M23A012	185	F023M33B012	185	F023M43D012	144	F02512CA018
183	F023L33A018	185	F023M23A018	185	F023M33B018	185	F023M43D018	144	F02512CA030
183	F023L33A030	185	F023M23A030	185	F023M33B030	185	F023M43D030	144	F02512CA033
183	F023L33A033	185	F023M23A033	185	F023M33B033	185	F023M43D033	144	F02512DA001
183	F023L41A001	185	F023M23B001	185	F023M33D001	170	F023Z020000	144	F02512DA006
183	F023L41A006	185	F023M23B006	185	F023M33D006	171	F023Z030000	144	F02512DA012
183	F023L41A012	185	F023M23B012	185	F023M33D012	171	F023Z040000	144	F02512DA018
183	F023L41A018	185	F023M23B018	185	F023M33D018	166	F023Z050000	144	F02512DA030
183	F023L41A030	185	F023M23B030	185	F023M33D030	169	F023Z060000	144	F02512DA033
183	F023L41A033	185	F023M23B033	185	F023M33D033	130	F02502BA001	145	F02512EA001
183	F023L42A001	185	F023M23D001	184	F023M41A001	130	F02502BA006	145	F02512EA006
183	F023L42A006	185	F023M23D006	184	F023M41A006	130	F02502BA012	145	F02512EA012
183	F023L42A012	185	F023M23D012	184	F023M41A012	130	F02502BA018	145	F02512EA018
183	F023L42A018	185	F023M23D018	184	F023M41A018	130	F02502BA030	145	F02512EA030
183	F023L42A030	185	F023M23D030	184	F023M41A030	130	F02502BA033	145	F02512EA033

Page	Reference	Page	Reference	Page	Reference	Page	Reference	Page	Reference
132	F02553CA001	133	F02554EA001	135	F02562HA001	134	F02564DA001	36	F025A4CA001
132	F02553CA006	133	F02554EA006	135	F02562HA006	134	F02564DA006	36	F025A4CA006
132	F02553CA012	133	F02554EA012	135	F02562HA012	134	F02564DA012	36	F025A4CA012
132	F02553CA018	133	F02554EA018	135	F02562HA018	134	F02564DA018	36	F025A4CA018
132	F02553CA030	133	F02554EA030	135	F02562HA030	134	F02564DA030	36	F025A4CA030
132	F02553CA033	133	F02554EA033	135	F02562HA033	134	F02564DA033	36	F025A4CA033
132	F02553DA001	133	F02554FA001	134	F02563BA001	134	F02564EA001	48	F025B2AA001
132	F02553DA006	133	F02554FA006	134	F02563BA006	134	F02564EA006	48	F025B2AA006
132	F02553DA012	133	F02554FA012	134	F02563BA012	134	F02564EA012	48	F025B2AA012
132	F02553DA018	133	F02554FA018	134	F02563BA018	134	F02564EA018	48	F025B2AA018
132	F02553DA030	133	F02554FA030	134	F02563BA030	134	F02564EA030	48	F025B2AA030
132	F02553DA033	133	F02554FA033	134	F02563BA033	134	F02564EA033	48	F025B2AA033
133	F02553EA001	133	F02554GA001	134	F02563CA001	135	F02564FA001	48	F025B2BA001
133	F02553EA006	133	F02554GA006	134	F02563CA006	135	F02564FA006	48	F025B2BA006
133	F02553EA012	133	F02554GA012	134	F02563CA012	135	F02564FA012	48	F025B2BA012
133	F02553EA018	133	F02554GA018	134	F02563CA018	135	F02564FA018	48	F025B2BA018
133	F02553EA030	133	F02554GA030	134	F02563CA030	135	F02564FA030	48	F025B2BA030
133	F02553EA033	133	F02554GA033	134	F02563CA033	135	F02564FA033	48	F025B2BA033
133	F02553FA001	133	F02554HA001	134	F02563DA001	135	F02564GA001	48	F025B2CA001
133	F02553FA006	133	F02554HA006	134	F02563DA006	135	F02564GA006	48	F025B2CA006
133	F02553FA012	133	F02554HA012	134	F02563DA012	135	F02564GA012	48	F025B2CA012
133	F02553FA018	133	F02554HA018	134	F02563DA018	135	F02564GA018	48	F025B2CA018
133	F02553FA030	133	F02554HA030	134	F02563DA030	135	F02564GA030	48	F025B2CA030
133	F02553FA033	133	F02554HA033	134	F02563DA033	135	F02564GA033	48	F025B2CA033
133	F02553GA001	134	F02562BA001	134	F02563EA001	135	F02564HA001	48	F025B2DA001
133	F02553GA006	134	F02562BA006	134	F02563EA006	135	F02564HA006	48	F025B2DA006
133	F02553GA012	134	F02562BA012	134	F02563EA012	135	F02564HA012	48	F025B2DA012
133	F02553GA018	134	F02562BA018	134	F02563EA018	135	F02564HA018	48	F025B2DA018
133	F02553GA030	134	F02562BA030	134	F02563EA030	135	F02564HA030	48	F025B2DA030
133	F02553GA033	134	F02562BA033	134	F02563EA033	135	F02564HA033	48	F025B2DA033
133	F02553HA001	134	F02562CA001	135	F02563FA001	36	F025A2BA001	49	F025B2EA001
133	F02553HA006	134	F02562CA006	135	F02563FA006	36	F025A2BA006	49	F025B2EA006
133	F02553HA012	134	F02562CA012	135	F02563FA012	36	F025A2BA012	49	F025B2EA012
133	F02553HA018	134	F02562CA018	135	F02563FA018	36	F025A2BA018	49	F025B2EA018
133	F02553HA030	134	F02562CA030	135	F02563FA030	36	F025A2BA030	49	F025B2EA030
133	F02553HA033	134	F02562CA033	135	F02563FA033	36	F025A2BA033	49	F025B2EA033
132	F02554AA001	134	F02562DA001	135	F02563GA001	36	F025A2CA001	49	F025B2FA001
132	F02554AA006	134	F02562DA006	135	F02563GA006	36	F025A2CA006	49	F025B2FA006
132	F02554AA012	134	F02562DA012	135	F02563GA012	36	F025A2CA012	49	F025B2FA012
132	F02554AA018	134	F02562DA018	135	F02563GA018	36	F025A2CA018	49	F025B2FA018
132	F02554AA030	134	F02562DA030	135	F02563GA030	36	F025A2CA030	49	F025B2FA030
132	F02554AA033	134	F02562DA033	135	F02563GA033	36	F025A2CA033	49	F025B2FA033
132	F02554BA001	134	F02562EA001	135	F02563HA001	36	F025A3BA001	49	F025B2GA001
132	F02554BA006	134	F02562EA006	135	F02563HA006	36	F025A3BA006	49	F025B2GA006
132	F02554BA012	134	F02562EA012	135	F02563HA012	36	F025A3BA012	49	F025B2GA012
132	F02554BA018	134	F02562EA018	135	F02563HA018	36	F025A3BA018	49	F025B2GA018
132	F02554BA030	134	F02562EA030	135	F02563HA030	36	F025A3BA030	49	F025B2GA030
132	F02554BA033	134	F02562EA033	135	F02563HA033	36	F025A3BA033	49	F025B2GA033
132	F02554CA001	135	F02562FA001	134	F02564BA001	36	F025A3CA001	49	F025B2HA001
132	F02554CA006	135	F02562FA006	134	F02564BA006	36	F025A3CA006	49	F025B2HA006
132	F02554CA012	135	F02562FA012	134	F02564BA012	36	F025A3CA012	49	F025B2HA012
132	F02554CA018	135	F02562FA018	134	F02564BA018	36	F025A3CA018	49	F025B2HA018
132	F02554CA030	135	F02562FA030	134	F02564BA030	36	F025A3CA030	49	F025B2HA030
132	F02554CA033	135	F02562FA033	134	F02564BA033	36	F025A3CA033	49	F025B2HA033
132	F02554DA001	135	F02562GA001	134	F02564CA001	36	F025A4BA001	48	F025B3AA001
132	F02554DA006	135	F02562GA006	134	F02564CA006	36	F025A4BA006	48	F025B3AA006
132	F02554DA012	135	F02562GA012	134	F02564CA012	36	F025A4BA012	48	F025B3AA012
132	F02554DA018	135	F02562GA018	134	F02564CA018	36	F025A4BA018	48	F025B3AA018
132	F02554DA030	135	F02562GA030	134	F02564CA030	36	F025A4BA030	48	F025B3AA030
132	F02554DA033	135	F02562GA033	134	F02564CA033	36	F025A4BA033	48	F025B3AA033

Page	Reference	Page	Reference	Page	Reference	Page	Reference	Page	Reference
48	F025B3BA001	48	F025B4DA001	51	F025C2GA001	50	F025C4CA001	39	F025D2EA001
48	F025B3BA006	48	F025B4DA006	51	F025C2GA006	50	F025C4CA006	39	F025D2EA006
48	F025B3BA012	48	F025B4DA012	51	F025C2GA012	50	F025C4CA012	39	F025D2EA012
48	F025B3BA018	48	F025B4DA018	51	F025C2GA018	50	F025C4CA018	39	F025D2EA018
48	F025B3BA030	48	F025B4DA030	51	F025C2GA030	50	F025C4CA030	39	F025D2EA030
48	F025B3BA033	48	F025B4DA033	51	F025C2GA033	50	F025C4CA033	39	F025D2EA033
48	F025B3CA001	49	F025B4EA001	51	F025C2HA001	50	F025C4DA001	39	F025D2FA001
48	F025B3CA006	49	F025B4EA006	51	F025C2HA006	50	F025C4DA006	39	F025D2FA006
48	F025B3CA012	49	F025B4EA012	51	F025C2HA012	50	F025C4DA012	39	F025D2FA012
48	F025B3CA018	49	F025B4EA018	51	F025C2HA018	50	F025C4DA018	39	F025D2FA018
48	F025B3CA030	49	F025B4EA030	51	F025C2HA030	50	F025C4DA030	39	F025D2FA030
48	F025B3CA033	49	F025B4EA033	51	F025C2HA033	50	F025C4DA033	39	F025D2FA033
48	F025B3DA001	49	F025B4FA001	50	F025C3BA001	50	F025C4EA001	39	F025D2GA001
48	F025B3DA006	49	F025B4FA006	50	F025C3BA006	50	F025C4EA006	39	F025D2GA006
48	F025B3DA012	49	F025B4FA012	50	F025C3BA012	50	F025C4EA012	39	F025D2GA012
48	F025B3DA018	49	F025B4FA018	50	F025C3BA018	50	F025C4EA018	39	F025D2GA018
48	F025B3DA030	49	F025B4FA030	50	F025C3BA030	50	F025C4EA030	39	F025D2GA030
48	F025B3DA033	49	F025B4FA033	50	F025C3BA033	50	F025C4EA033	39	F025D2GA033
49	F025B3EA001	49	F025B4GA001	50	F025C3CA001	51	F025C4FA001	39	F025D2HA001
49	F025B3EA006	49	F025B4GA006	50	F025C3CA006	51	F025C4FA006	39	F025D2HA006
49	F025B3EA012	49	F025B4GA012	50	F025C3CA012	51	F025C4FA012	39	F025D2HA012
49	F025B3EA018	49	F025B4GA018	50	F025C3CA018	51	F025C4FA018	39	F025D2HA018
49	F025B3EA030	49	F025B4GA030	50	F025C3CA030	51	F025C4FA030	39	F025D2HA030
49	F025B3EA033	49	F025B4GA033	50	F025C3CA033	51	F025C4FA033	39	F025D2HA033
49	F025B3FA001	49	F025B4HA001	50	F025C3DA001	51	F025C4GA001	38	F025D3AA001
49	F025B3FA006	49	F025B4HA006	50	F025C3DA006	51	F025C4GA006	38	F025D3AA006
49	F025B3FA012	49	F025B4HA012	50	F025C3DA012	51	F025C4GA012	38	F025D3AA012
49	F025B3FA018	49	F025B4HA018	50	F025C3DA018	51	F025C4GA018	38	F025D3AA018
49	F025B3FA030	49	F025B4HA030	50	F025C3DA030	51	F025C4GA030	38	F025D3AA030
49	F025B3FA033	49	F025B4HA033	50	F025C3DA033	51	F025C4GA033	38	F025D3AA033
49	F025B3GA001	50	F025C2BA001	50	F025C3EA001	51	F025C4HA001	38	F025D3BA001
49	F025B3GA006	50	F025C2BA006	50	F025C3EA006	51	F025C4HA006	38	F025D3BA006
49	F025B3GA012	50	F025C2BA012	50	F025C3EA012	51	F025C4HA012	38	F025D3BA012
49	F025B3GA018	50	F025C2BA018	50	F025C3EA018	51	F025C4HA018	38	F025D3BA018
49	F025B3GA030	50	F025C2BA030	50	F025C3EA030	51	F025C4HA030	38	F025D3BA030
49	F025B3GA033	50	F025C2BA033	50	F025C3EA033	51	F025C4HA033	38	F025D3BA033
49	F025B3HA001	50	F025C2CA001	51	F025C3FA001	38	F025D2AA001	38	F025D3CA001
49	F025B3HA006	50	F025C2CA006	51	F025C3FA006	38	F025D2AA006	38	F025D3CA006
49	F025B3HA012	50	F025C2CA012	51	F025C3FA012	38	F025D2AA012	38	F025D3CA012
49	F025B3HA018	50	F025C2CA018	51	F025C3FA018	38	F025D2AA018	38	F025D3CA018
49	F025B3HA030	50	F025C2CA030	51	F025C3FA030	38	F025D2AA030	38	F025D3CA030
49	F025B3HA033	50	F025C2CA033	51	F025C3FA033	38	F025D2AA033	38	F025D3CA033
48	F025B4AA001	50	F025C2DA001	51	F025C3GA001	38	F025D2BA001	38	F025D3DA001
48	F025B4AA006	50	F025C2DA006	51	F025C3GA006	38	F025D2BA006	38	F025D3DA006
48	F025B4AA012	50	F025C2DA012	51	F025C3GA012	38	F025D2BA012	38	F025D3DA012
48	F025B4AA018	50	F025C2DA018	51	F025C3GA018	38	F025D2BA018	38	F025D3DA018
48	F025B4AA030	50	F025C2DA030	51	F025C3GA030	38	F025D2BA030	38	F025D3DA030
48	F025B4AA033	50	F025C2DA033	51	F025C3GA033	38	F025D2BA033	38	F025D3DA033
48	F025B4BA001	50	F025C2EA001	51	F025C3HA001	38	F025D2CA001	39	F025D3EA001
48	F025B4BA006	50	F025C2EA006	51	F025C3HA006	38	F025D2CA006	39	F025D3EA006
48	F025B4BA012	50	F025C2EA012	51	F025C3HA012	38	F025D2CA012	39	F025D3EA012
48	F025B4BA018	50	F025C2EA018	51	F025C3HA018	38	F025D2CA018	39	F025D3EA018
48	F025B4BA030	50	F025C2EA030	51	F025C3HA030	38	F025D2CA030	39	F025D3EA030
48	F025B4BA033	50	F025C2EA033	51	F025C3HA033	38	F025D2CA033	39	F025D3EA033
48	F025B4CA001	51	F025C2FA001	50	F025C4BA001	38	F025D2DA001	39	F025D3FA001
48	F025B4CA006	51	F025C2FA006	50	F025C4BA006	38	F025D2DA006	39	F025D3FA006
48	F025B4CA012	51	F025C2FA012	50	F025C4BA012	38	F025D2DA012	39	F025D3FA012
48	F025B4CA018	51	F025C2FA018	50	F025C4BA018	38	F025D2DA018	39	F025D3FA018
48	F025B4CA030	51	F025C2FA030	50	F025C4BA030	38	F025D2DA030	39	F025D3FA030
48	F025B4CA033	51	F025C2FA033	50	F025C4BA033	38	F025D2DA033	39	F025D3FA033

Page	Reference	Page	Reference	Page	Reference	Page	Reference	Page	Reference
68	F025L4CA001	71	F025M2FA001	70	F025M4BA001	96	F025Q3CA001	111	F025R2HA001
68	F025L4CA006	71	F025M2FA006	70	F025M4BA006	96	F025Q3CA006	111	F025R2HA006
68	F025L4CA012	71	F025M2FA012	70	F025M4BA012	96	F025Q3CA012	111	F025R2HA012
68	F025L4CA018	71	F025M2FA018	70	F025M4BA018	96	F025Q3CA018	111	F025R2HA018
68	F025L4CA030	71	F025M2FA030	70	F025M4BA030	96	F025Q3CA030	111	F025R2HA030
68	F025L4CA033	71	F025M2FA033	70	F025M4BA033	96	F025Q3CA033	111	F025R2HA033
68	F025L4DA001	71	F025M2GA001	70	F025M4CA001	96	F025Q4BA001	110	F025R3AA001
68	F025L4DA006	71	F025M2GA006	70	F025M4CA006	96	F025Q4BA006	110	F025R3AA006
68	F025L4DA012	71	F025M2GA012	70	F025M4CA012	96	F025Q4BA012	110	F025R3AA012
68	F025L4DA018	71	F025M2GA018	70	F025M4CA018	96	F025Q4BA018	110	F025R3AA018
68	F025L4DA030	71	F025M2GA030	70	F025M4CA030	96	F025Q4BA030	110	F025R3AA030
68	F025L4DA033	71	F025M2GA033	70	F025M4CA033	96	F025Q4BA033	110	F025R3AA033
69	F025L4EA001	71	F025M2HA001	70	F025M4DA001	96	F025Q4CA001	110	F025R3BA001
69	F025L4EA006	71	F025M2HA006	70	F025M4DA006	96	F025Q4CA006	110	F025R3BA006
69	F025L4EA012	71	F025M2HA012	70	F025M4DA012	96	F025Q4CA012	110	F025R3BA012
69	F025L4EA018	71	F025M2HA018	70	F025M4DA018	96	F025Q4CA018	110	F025R3BA018
69	F025L4EA030	71	F025M2HA030	70	F025M4DA030	96	F025Q4CA030	110	F025R3BA030
69	F025L4EA033	71	F025M2HA033	70	F025M4DA033	96	F025Q4CA033	110	F025R3BA033
69	F025L4FA001	70	F025M3BA001	70	F025M4EA001	110	F025R2AA001	110	F025R3CA001
69	F025L4FA006	70	F025M3BA006	70	F025M4EA006	110	F025R2AA006	110	F025R3CA006
69	F025L4FA012	70	F025M3BA012	70	F025M4EA012	110	F025R2AA012	110	F025R3CA012
69	F025L4FA018	70	F025M3BA018	70	F025M4EA018	110	F025R2AA018	110	F025R3CA018
69	F025L4FA030	70	F025M3BA030	70	F025M4EA030	110	F025R2AA030	110	F025R3CA030
69	F025L4FA033	70	F025M3BA033	70	F025M4EA033	110	F025R2AA033	110	F025R3CA033
69	F025L4GA001	70	F025M3CA001	71	F025M4FA001	110	F025R2BA001	110	F025R3DA001
69	F025L4GA006	70	F025M3CA006	71	F025M4FA006	110	F025R2BA006	110	F025R3DA006
69	F025L4GA012	70	F025M3CA012	71	F025M4FA012	110	F025R2BA012	110	F025R3DA012
69	F025L4GA018	70	F025M3CA018	71	F025M4FA018	110	F025R2BA018	110	F025R3DA018
69	F025L4GA030	70	F025M3CA030	71	F025M4FA030	110	F025R2BA030	110	F025R3DA030
69	F025L4GA033	70	F025M3CA033	71	F025M4FA033	110	F025R2BA033	110	F025R3DA033
69	F025L4HA001	70	F025M3DA001	71	F025M4GA001	110	F025R2CA001	111	F025R3EA001
69	F025L4HA006	70	F025M3DA006	71	F025M4GA006	110	F025R2CA006	111	F025R3EA006
69	F025L4HA012	70	F025M3DA012	71	F025M4GA012	110	F025R2CA012	111	F025R3EA012
69	F025L4HA018	70	F025M3DA018	71	F025M4GA018	110	F025R2CA018	111	F025R3EA018
69	F025L4HA030	70	F025M3DA030	71	F025M4GA030	110	F025R2CA030	111	F025R3EA030
69	F025L4HA033	70	F025M3DA033	71	F025M4GA033	110	F025R2CA033	111	F025R3EA033
70	F025M2BA001	70	F025M3EA001	71	F025M4HA001	110	F025R2DA001	111	F025R3FA001
70	F025M2BA006	70	F025M3EA006	71	F025M4HA006	110	F025R2DA006	111	F025R3FA006
70	F025M2BA012	70	F025M3EA012	71	F025M4HA012	110	F025R2DA012	111	F025R3FA012
70	F025M2BA018	70	F025M3EA018	71	F025M4HA018	110	F025R2DA018	111	F025R3FA018
70	F025M2BA030	70	F025M3EA030	71	F025M4HA030	110	F025R2DA030	111	F025R3FA030
70	F025M2BA033	70	F025M3EA033	71	F025M4HA033	110	F025R2DA033	111	F025R3FA033
70	F025M2CA001	71	F025M3FA001	96	F025Q2BA001	111	F025R2EA001	111	F025R3GA001
70	F025M2CA006	71	F025M3FA006	96	F025Q2BA006	111	F025R2EA006	111	F025R3GA006
70	F025M2CA012	71	F025M3FA012	96	F025Q2BA012	111	F025R2EA012	111	F025R3GA012
70	F025M2CA018	71	F025M3FA018	96	F025Q2BA018	111	F025R2EA018	111	F025R3GA018
70	F025M2CA030	71	F025M3FA030	96	F025Q2BA030	111	F025R2EA030	111	F025R3GA030
70	F025M2CA033	71	F025M3FA033	96	F025Q2BA033	111	F025R2EA033	111	F025R3GA033
70	F025M2DA001	71	F025M3GA001	96	F025Q2CA001	111	F025R2FA001	111	F025R3HA001
70	F025M2DA006	71	F025M3GA006	96	F025Q2CA006	111	F025R2FA006	111	F025R3HA006
70	F025M2DA012	71	F025M3GA012	96	F025Q2CA012	111	F025R2FA012	111	F025R3HA012
70	F025M2DA018	71	F025M3GA018	96	F025Q2CA018	111	F025R2FA018	111	F025R3HA018
70	F025M2DA030	71	F025M3GA030	96	F025Q2CA030	111	F025R2FA030	111	F025R3HA030
70	F025M2DA033	71	F025M3GA033	96	F025Q2CA033	111	F025R2FA033	111	F025R3HA033
70	F025M2EA001	71	F025M3HA001	96	F025Q3BA001	111	F025R2GA001	110	F025R4AA001
70	F025M2EA006	71	F025M3HA006	96	F025Q3BA006	111	F025R2GA006	110	F025R4AA006
70	F025M2EA012	71	F025M3HA012	96	F025Q3BA012	111	F025R2GA012	110	F025R4AA012
70	F025M2EA018	71	F025M3HA018	96	F025Q3BA018	111	F025R2GA018	110	F025R4AA018
70	F025M2EA030	71	F025M3HA030	96	F025Q3BA030	111	F025R2GA030	110	F025R4AA030
70	F025M2EA033	71	F025M3HA033	96	F025Q3BA033	111	F025R2GA033	110	F025R4AA033

Page	Reference	Page	Reference	Page	Reference	Page	Reference	Page	Reference
110	F025R4BA001	112	F025S2EA001	113	F025S3HA001	98	F025V2CA001	99	F025V3EA001
110	F025R4BA006	112	F025S2EA006	113	F025S3HA006	98	F025V2CA006	99	F025V3EA006
110	F025R4BA012	112	F025S2EA012	113	F025S3HA012	98	F025V2CA012	99	F025V3EA012
110	F025R4BA018	112	F025S2EA018	113	F025S3HA018	98	F025V2CA018	99	F025V3EA018
110	F025R4BA030	112	F025S2EA030	113	F025S3HA030	98	F025V2CA030	99	F025V3EA030
110	F025R4BA033	112	F025S2EA033	113	F025S3HA033	98	F025V2CA033	99	F025V3EA033
110	F025R4CA001	113	F025S2FA001	112	F025S4BA001	98	F025V2DA001	99	F025V3FA001
110	F025R4CA006	113	F025S2FA006	112	F025S4BA006	98	F025V2DA006	99	F025V3FA006
110	F025R4CA012	113	F025S2FA012	112	F025S4BA012	98	F025V2DA012	99	F025V3FA012
110	F025R4CA018	113	F025S2FA018	112	F025S4BA018	98	F025V2DA018	99	F025V3FA018
110	F025R4CA030	113	F025S2FA030	112	F025S4BA030	98	F025V2DA030	99	F025V3FA030
110	F025R4CA033	113	F025S2FA033	112	F025S4BA033	98	F025V2DA033	99	F025V3FA033
110	F025R4DA001	113	F025S2GA001	112	F025S4CA001	99	F025V2EA001	99	F025V3GA001
110	F025R4DA006	113	F025S2GA006	112	F025S4CA006	99	F025V2EA006	99	F025V3GA006
110	F025R4DA012	113	F025S2GA012	112	F025S4CA012	99	F025V2EA012	99	F025V3GA012
110	F025R4DA018	113	F025S2GA018	112	F025S4CA018	99	F025V2EA018	99	F025V3GA018
110	F025R4DA030	113	F025S2GA030	112	F025S4CA030	99	F025V2EA030	99	F025V3GA030
110	F025R4DA033	113	F025S2GA033	112	F025S4CA033	99	F025V2EA033	99	F025V3GA033
111	F025R4EA001	113	F025S2HA001	112	F025S4DA001	99	F025V2FA001	99	F025V3HA001
111	F025R4EA006	113	F025S2HA006	112	F025S4DA006	99	F025V2FA006	99	F025V3HA006
111	F025R4EA012	113	F025S2HA012	112	F025S4DA012	99	F025V2FA012	99	F025V3HA012
111	F025R4EA018	113	F025S2HA018	112	F025S4DA018	99	F025V2FA018	99	F025V3HA018
111	F025R4EA030	113	F025S2HA030	112	F025S4DA030	99	F025V2FA030	99	F025V3HA030
111	F025R4EA033	113	F025S2HA033	112	F025S4DA033	99	F025V2FA033	99	F025V3HA033
111	F025R4FA001	112	F025S3BA001	112	F025S4EA001	99	F025V2GA001	98	F025V4AA001
111	F025R4FA006	112	F025S3BA006	112	F025S4EA006	99	F025V2GA006	98	F025V4AA006
111	F025R4FA012	112	F025S3BA012	112	F025S4EA012	99	F025V2GA012	98	F025V4AA012
111	F025R4FA018	112	F025S3BA018	112	F025S4EA018	99	F025V2GA018	98	F025V4AA018
111	F025R4FA030	112	F025S3BA030	112	F025S4EA030	99	F025V2GA030	98	F025V4AA030
111	F025R4FA033	112	F025S3BA033	112	F025S4EA033	99	F025V2GA033	98	F025V4AA033
111	F025R4GA001	112	F025S3CA001	113	F025S4FA001	99	F025V2HA001	98	F025V4BA001
111	F025R4GA006	112	F025S3CA006	113	F025S4FA006	99	F025V2HA006	98	F025V4BA006
111	F025R4GA012	112	F025S3CA012	113	F025S4FA012	99	F025V2HA012	98	F025V4BA012
111	F025R4GA018	112	F025S3CA018	113	F025S4FA018	99	F025V2HA018	98	F025V4BA018
111	F025R4GA030	112	F025S3CA030	113	F025S4FA030	99	F025V2HA030	98	F025V4BA030
111	F025R4GA033	112	F025S3CA033	113	F025S4FA033	99	F025V2HA033	98	F025V4BA033
111	F025R4HA001	112	F025S3DA001	113	F025S4GA001	98	F025V3AA001	98	F025V4CA001
111	F025R4HA006	112	F025S3DA006	113	F025S4GA006	98	F025V3AA006	98	F025V4CA006
111	F025R4HA012	112	F025S3DA012	113	F025S4GA012	98	F025V3AA012	98	F025V4CA012
111	F025R4HA018	112	F025S3DA018	113	F025S4GA018	98	F025V3AA018	98	F025V4CA018
111	F025R4HA030	112	F025S3DA030	113	F025S4GA030	98	F025V3AA030	98	F025V4CA030
111	F025R4HA033	112	F025S3DA033	113	F025S4GA033	98	F025V3AA033	98	F025V4CA033
112	F025S2BA001	112	F025S3EA001	113	F025S4HA001	98	F025V3BA001	98	F025V4DA001
112	F025S2BA006	112	F025S3EA006	113	F025S4HA006	98	F025V3BA006	98	F025V4DA006
112	F025S2BA012	112	F025S3EA012	113	F025S4HA012	98	F025V3BA012	98	F025V4DA012
112	F025S2BA018	112	F025S3EA018	113	F025S4HA018	98	F025V3BA018	98	F025V4DA018
112	F025S2BA030	112	F025S3EA030	113	F025S4HA030	98	F025V3BA030	98	F025V4DA030
112	F025S2BA033	112	F025S3EA033	113	F025S4HA033	98	F025V3BA033	98	F025V4DA033
112	F025S2CA001	113	F025S3FA001	98	F025V2AA001	98	F025V3CA001	99	F025V4EA001
112	F025S2CA006	113	F025S3FA006	98	F025V2AA006	98	F025V3CA006	99	F025V4EA006
112	F025S2CA012	113	F025S3FA012	98	F025V2AA012	98	F025V3CA012	99	F025V4EA012
112	F025S2CA018	113	F025S3FA018	98	F025V2AA018	98	F025V3CA018	99	F025V4EA018
112	F025S2CA030	113	F025S3FA030	98	F025V2AA030	98	F025V3CA030	99	F025V4EA030
112	F025S2CA033	113	F025S3FA033	98	F025V2AA033	98	F025V3CA033	99	F025V4EA033
112	F025S2DA001	113	F025S3GA001	98	F025V2BA001	98	F025V3DA001	99	F025V4FA001
112	F025S2DA006	113	F025S3GA006	98	F025V2BA006	98	F025V3DA006	99	F025V4FA006
112	F025S2DA012	113	F025S3GA012	98	F025V2BA012	98	F025V3DA012	99	F025V4FA012
112	F025S2DA018	113	F025S3GA018	98	F025V2BA018	98	F025V3DA018	99	F025V4FA018
112	F025S2DA030	113	F025S3GA030	98	F025V2BA030	98	F025V3DA030	99	F025V4FA030
112	F025S2DA033	113	F025S3GA033	98	F025V2BA033	98	F025V3DA033	99	F025V4FA033

Page	Reference	Page	Reference	Page	Reference	Page	Reference	Page	Reference
99	F025V4GA001	100	F025W3CA001	101	F025W4FA001	131	F02602CD033.A	131	F02604CA033.A
99	F025V4GA006	100	F025W3CA006	101	F025W4FA006	131	F02603BA001	131	F02604CB001.A
99	F025V4GA012	100	F025W3CA012	101	F025W4FA012	131	F02603BA006	131	F02604CB006.A
99	F025V4GA018	100	F025W3CA018	101	F025W4FA018	131	F02603BA012	131	F02604CB012.A
99	F025V4GA030	100	F025W3CA030	101	F025W4FA030	131	F02603BA018	131	F02604CB018.A
99	F025V4GA033	100	F025W3CA033	101	F025W4FA033	131	F02603BA030	131	F02604CB030.A
99	F025V4HA001	100	F025W3DA001	101	F025W4GA001	131	F02603BA033	131	F02604CB033.A
99	F025V4HA006	100	F025W3DA006	101	F025W4GA006	131	F02603BB001	131	F02604CD001.A
99	F025V4HA012	100	F025W3DA012	101	F025W4GA012	131	F02603BB006	131	F02604CD006.A
99	F025V4HA018	100	F025W3DA018	101	F025W4GA018	131	F02603BB012	131	F02604CD012.A
99	F025V4HA030	100	F025W3DA030	101	F025W4GA030	131	F02603BB018	131	F02604CD018.A
99	F025V4HA033	100	F025W3DA033	101	F025W4GA033	131	F02603BB030	131	F02604CD030.A
100	F025W2BA001	100	F025W3EA001	101	F025W4HA001	131	F02603BB033	131	F02604CD033.A
100	F025W2BA006	100	F025W3EA006	101	F025W4HA006	131	F02603BD001	148	F02612AA001
100	F025W2BA012	100	F025W3EA012	101	F025W4HA012	131	F02603BD006	148	F02612AA006
100	F025W2BA018	100	F025W3EA018	101	F025W4HA018	131	F02603BD012	148	F02612AA012
100	F025W2BA030	100	F025W3EA030	101	F025W4HA030	131	F02603BD018	148	F02612AA018
100	F025W2BA033	100	F025W3EA033	101	F025W4HA033	131	F02603BD030	148	F02612AA030
100	F025W2CA001	101	F025W3FA001	51	F025Z050001	131	F02603BD033	148	F02612AA033
100	F025W2CA006	101	F025W3FA006	51	F025Z050006	131	F02603CA001	148	F02612AB001
100	F025W2CA012	101	F025W3FA012	51	F025Z050012	131	F02603CA006	148	F02612AB006
100	F025W2CA018	101	F025W3FA018	51	F025Z050018	131	F02603CA012	148	F02612AB012
100	F025W2CA030	101	F025W3FA030	51	F025Z050030	131	F02603CA018	148	F02612AB018
100	F025W2CA033	101	F025W3FA033	51	F025Z050033	131	F02603CA030	148	F02612AB030
100	F025W2DA001	101	F025W3GA001	36	F025Z060000	131	F02603CA033	148	F02612AB033
100	F025W2DA006	101	F025W3GA006	131	F02602BA001.A	131	F02603CB001	148	F02612AD001
100	F025W2DA012	101	F025W3GA012	131	F02602BA006.A	131	F02603CB006	148	F02612AD006
100	F025W2DA018	101	F025W3GA018	131	F02602BA012.A	131	F02603CB012	148	F02612AD012
100	F025W2DA030	101	F025W3GA030	131	F02602BA018.A	131	F02603CB018	148	F02612AD018
100	F025W2DA033	101	F025W3GA033	131	F02602BA030.A	131	F02603CB030	148	F02612AD030
100	F025W2EA001	101	F025W3HA001	131	F02602BA033.A	131	F02603CB033	148	F02612AD033
100	F025W2EA006	101	F025W3HA006	131	F02602BB001.A	131	F02603CD001	148	F02612BA001
100	F025W2EA012	101	F025W3HA012	131	F02602BB006.A	131	F02603CD006	148	F02612BA006
100	F025W2EA018	101	F025W3HA018	131	F02602BB012.A	131	F02603CD012	148	F02612BA012
100	F025W2EA030	101	F025W3HA030	131	F02602BB018.A	131	F02603CD018	148	F02612BA018
100	F025W2EA033	101	F025W3HA033	131	F02602BB030.A	131	F02603CD030	148	F02612BA030
101	F025W2FA001	100	F025W4BA001	131	F02602BB033.A	131	F02603CD033	148	F02612BA033
101	F025W2FA006	100	F025W4BA006	131	F02602BD001.A	131	F02604BA001.A	148	F02612BB001
101	F025W2FA012	100	F025W4BA012	131	F02602BD006.A	131	F02604BA006.A	148	F02612BB006
101	F025W2FA018	100	F025W4BA018	131	F02602BD012.A	131	F02604BA012.A	148	F02612BB012
101	F025W2FA030	100	F025W4BA030	131	F02602BD018.A	131	F02604BA018.A	148	F02612BB018
101	F025W2FA033	100	F025W4BA033	131	F02602BD030.A	131	F02604BA030.A	148	F02612BB030
101	F025W2GA001	100	F025W4CA001	131	F02602BD033.A	131	F02604BA033.A	148	F02612BB033
101	F025W2GA006	100	F025W4CA006	131	F02602CA001.A	131	F02604BB001.A	148	F02612BD001
101	F025W2GA012	100	F025W4CA012	131	F02602CA006.A	131	F02604BB006.A	148	F02612BD006
101	F025W2GA018	100	F025W4CA018	131	F02602CA012.A	131	F02604BB012.A	148	F02612BD012
101	F025W2GA030	100	F025W4CA030	131	F02602CA018.A	131	F02604BB018.A	148	F02612BD018
101	F025W2GA033	100	F025W4CA033	131	F02602CA030.A	131	F02604BB030.A	148	F02612BD030
101	F025W2HA001	100	F025W4DA001	131	F02602CA033.A	131	F02604BB033.A	148	F02612BD033
101	F025W2HA006	100	F025W4DA006	131	F02602CB001.A	131	F02604BD001.A	149	F02612CA001
101	F025W2HA012	100	F025W4DA012	131	F02602CB006.A	131	F02604BD006.A	149	F02612CA006
101	F025W2HA018	100	F025W4DA018	131	F02602CB012.A	131	F02604BD012.A	149	F02612CA012
101	F025W2HA030	100	F025W4DA030	131	F02602CB018.A	131	F02604BD018.A	149	F02612CA018
101	F025W2HA033	100	F025W4DA033	131	F02602CB030.A	131	F02604BD030.A	149	F02612CA030
100	F025W3BA001	100	F025W4EA001	131	F02602CB033.A	131	F02604BD033.A	149	F02612CA033
100	F025W3BA006	100	F025W4EA006	131	F02602CD001.A	131	F02604CA001.A	149	F02612CB001
100	F025W3BA012	100	F025W4EA012	131	F02602CD006.A	131	F02604CA006.A	149	F02612CB006
100	F025W3BA018	100	F025W4EA018	131	F02602CD012.A	131	F02604CA012.A	149	F02612CB012
100	F025W3BA030	100	F025W4EA030	131	F02602CD018.A	131	F02604CA018.A	149	F02612CB018
100	F025W3BA033	100	F025W4EA033	131	F02602CD030.A	131	F02604CA030.A	149	F02612CB030

Page	Reference	Page	Reference	Page	Reference	Page	Reference	Page	Reference
140	F02664DD033	141	F02664HA033	37	F026A3BB033	37	F026A4CD033.A	53	F026B2DA033
140	F02664EA001	141	F02664HB001	37	F026A3BD001	52	F026B2AA001	53	F026B2DB001
140	F02664EA006	141	F02664HB006	37	F026A3BD006	52	F026B2AA006	53	F026B2DB006
140	F02664EA012	141	F02664HB012	37	F026A3BD012	52	F026B2AA012	53	F026B2DB012
140	F02664EA018	141	F02664HB018	37	F026A3BD018	52	F026B2AA018	53	F026B2DB018
140	F02664EA030	141	F02664HB030	37	F026A3BD030	52	F026B2AA030	53	F026B2DB030
140	F02664EA033	141	F02664HB033	37	F026A3BD033	52	F026B2AA033	53	F026B2DB033
140	F02664EB001	141	F02664HD001	37	F026A3CA001	52	F026B2AB001	53	F026B2DD001
140	F02664EB006	141	F02664HD006	37	F026A3CA006	52	F026B2AB006	53	F026B2DD006
140	F02664EB012	141	F02664HD012	37	F026A3CA012	52	F026B2AB012	53	F026B2DD012
140	F02664EB018	141	F02664HD018	37	F026A3CA018	52	F026B2AB018	53	F026B2DD018
140	F02664EB030	141	F02664HD030	37	F026A3CA030	52	F026B2AB030	53	F026B2DD030
140	F02664EB033	141	F02664HD033	37	F026A3CA033	52	F026B2AB033	53	F026B2DD033
140	F02664ED001	37	F026A2BA001.A	37	F026A3CB001	52	F026B2AD001	53	F026B2EA001
140	F02664ED006	37	F026A2BA006.A	37	F026A3CB006	52	F026B2AD006	53	F026B2EA006
140	F02664ED012	37	F026A2BA012.A	37	F026A3CB012	52	F026B2AD012	53	F026B2EA012
140	F02664ED018	37	F026A2BA018.A	37	F026A3CB018	52	F026B2AD018	53	F026B2EA018
140	F02664ED030	37	F026A2BA030.A	37	F026A3CB030	52	F026B2AD030	53	F026B2EA030
140	F02664ED033	37	F026A2BA033.A	37	F026A3CB033	52	F026B2AD033	53	F026B2EA033
140	F02664FA001	37	F026A2BB001.A	37	F026A3CD001	52	F026B2BA001	53	F026B2EB001
140	F02664FA006	37	F026A2BB006.A	37	F026A3CD006	52	F026B2BA006	53	F026B2EB006
140	F02664FA012	37	F026A2BB012.A	37	F026A3CD012	52	F026B2BA012	53	F026B2EB012
140	F02664FA018	37	F026A2BB018.A	37	F026A3CD018	52	F026B2BA018	53	F026B2EB018
140	F02664FA030	37	F026A2BB030.A	37	F026A3CD030	52	F026B2BA030	53	F026B2EB030
140	F02664FA033	37	F026A2BB033.A	37	F026A3CD033	52	F026B2BA033	53	F026B2EB033
140	F02664FB001	37	F026A2BD001.A	37	F026A4BA001.A	52	F026B2BB001	53	F026B2ED001
140	F02664FB006	37	F026A2BD006.A	37	F026A4BA006.A	52	F026B2BB006	53	F026B2ED006
140	F02664FB012	37	F026A2BD012.A	37	F026A4BA012.A	52	F026B2BB012	53	F026B2ED012
140	F02664FB018	37	F026A2BD018.A	37	F026A4BA018.A	52	F026B2BB018	53	F026B2ED018
140	F02664FB030	37	F026A2BD030.A	37	F026A4BA030.A	52	F026B2BB030	53	F026B2ED030
140	F02664FB033	37	F026A2BD033.A	37	F026A4BA033.A	52	F026B2BB033	53	F026B2ED033
140	F02664FD001	37	F026A2CA001.A	37	F026A4BB001.A	52	F026B2BD001	54	F026B2FA001
140	F02664FD006	37	F026A2CA006.A	37	F026A4BB006.A	52	F026B2BD006	54	F026B2FA006
140	F02664FD012	37	F026A2CA012.A	37	F026A4BB012.A	52	F026B2BD012	54	F026B2FA012
140	F02664FD018	37	F026A2CA018.A	37	F026A4BB018.A	52	F026B2BD018	54	F026B2FA018
140	F02664FD030	37	F026A2CA030.A	37	F026A4BB030.A	52	F026B2BD030	54	F026B2FA030
140	F02664FD033	37	F026A2CA033.A	37	F026A4BB033.A	52	F026B2BD033	54	F026B2FA033
141	F02664GA001	37	F026A2CB001.A	37	F026A4BD001.A	53	F026B2CA001	54	F026B2FB001
141	F02664GA006	37	F026A2CB006.A	37	F026A4BD006.A	53	F026B2CA006	54	F026B2FB006
141	F02664GA012	37	F026A2CB012.A	37	F026A4BD012.A	53	F026B2CA012	54	F026B2FB012
141	F02664GA018	37	F026A2CB018.A	37	F026A4BD018.A	53	F026B2CA018	54	F026B2FB018
141	F02664GA030	37	F026A2CB030.A	37	F026A4BD030.A	53	F026B2CA030	54	F026B2FB030
141	F02664GA033	37	F026A2CB033.A	37	F026A4BD033.A	53	F026B2CA033	54	F026B2FB033
141	F02664GB001	37	F026A2CD001.A	37	F026A4CA001.A	53	F026B2CB001	54	F026B2FD001
141	F02664GB006	37	F026A2CD006.A	37	F026A4CA006.A	53	F026B2CB006	54	F026B2FD006
141	F02664GB012	37	F026A2CD012.A	37	F026A4CA012.A	53	F026B2CB012	54	F026B2FD012
141	F02664GB018	37	F026A2CD018.A	37	F026A4CA018.A	53	F026B2CB018	54	F026B2FD018
141	F02664GB030	37	F026A2CD030.A	37	F026A4CA030.A	53	F026B2CB030	54	F026B2FD030
141	F02664GB033	37	F026A2CD033.A	37	F026A4CA033.A	53	F026B2CB033	54	F026B2FD033
141	F02664GD001	37	F026A3BA001	37	F026A4CB001.A	53	F026B2CD001	54	F026B2GA001
141	F02664GD006	37	F026A3BA006	37	F026A4CB006.A	53	F026B2CD006	54	F026B2GA006
141	F02664GD012	37	F026A3BA012	37	F026A4CB012.A	53	F026B2CD012	54	F026B2GA012
141	F02664GD018	37	F026A3BA018	37	F026A4CB018.A	53	F026B2CD018	54	F026B2GA018
141	F02664GD030	37	F026A3BA030	37	F026A4CB030.A	53	F026B2CD030	54	F026B2GA030
141	F02664GD033	37	F026A3BA033	37	F026A4CB033.A	53	F026B2CD033	54	F026B2GA033
141	F02664HA001	37	F026A3BB001	37	F026A4CD001.A	53	F026B2DA001	54	F026B2GB001
141	F02664HA006	37	F026A3BB006	37	F026A4CD006.A	53	F026B2DA006	54	F026B2GB006
141	F02664HA012	37	F026A3BB012	37	F026A4CD012.A	53	F026B2DA012	54	F026B2GB012
141	F02664HA018	37	F026A3BB018	37	F026A4CD018.A	53	F026B2DA018	54	F026B2GB018
141	F02664HA030	37	F026A3BB030	37	F026A4CD030.A	53	F026B2DA030	54	F026B2GB030

Page	Reference	Page	Reference	Page	Reference	Page	Reference	Page	Reference
54	F026B2GB033	52	F026B3BD033	54	F026B3FA033	52	F026B4AB033	53	F026B4DD033
54	F026B2GD001	53	F026B3CA001	54	F026B3FB001	52	F026B4AD001	53	F026B4EA001
54	F026B2GD006	53	F026B3CA006	54	F026B3FB006	52	F026B4AD006	53	F026B4EA006
54	F026B2GD012	53	F026B3CA012	54	F026B3FB012	52	F026B4AD012	53	F026B4EA012
54	F026B2GD018	53	F026B3CA018	54	F026B3FB018	52	F026B4AD018	53	F026B4EA018
54	F026B2GD030	53	F026B3CA030	54	F026B3FB030	52	F026B4AD030	53	F026B4EA030
54	F026B2GD033	53	F026B3CA033	54	F026B3FB033	52	F026B4AD033	53	F026B4EA033
54	F026B2HA001	53	F026B3CB001	54	F026B3FD001	52	F026B4BA001	53	F026B4EB001
54	F026B2HA006	53	F026B3CB006	54	F026B3FD006	52	F026B4BA006	53	F026B4EB006
54	F026B2HA012	53	F026B3CB012	54	F026B3FD012	52	F026B4BA012	53	F026B4EB012
54	F026B2HA018	53	F026B3CB018	54	F026B3FD018	52	F026B4BA018	53	F026B4EB018
54	F026B2HA030	53	F026B3CB030	54	F026B3FD030	52	F026B4BA030	53	F026B4EB030
54	F026B2HA033	53	F026B3CB033	54	F026B3FD033	52	F026B4BA033	53	F026B4EB033
54	F026B2HB001	53	F026B3CD001	54	F026B3GA001	52	F026B4BB001	53	F026B4ED001
54	F026B2HB006	53	F026B3CD006	54	F026B3GA006	52	F026B4BB006	53	F026B4ED006
54	F026B2HB012	53	F026B3CD012	54	F026B3GA012	52	F026B4BB012	53	F026B4ED012
54	F026B2HB018	53	F026B3CD018	54	F026B3GA018	52	F026B4BB018	53	F026B4ED018
54	F026B2HB030	53	F026B3CD030	54	F026B3GA030	52	F026B4BB030	53	F026B4ED030
54	F026B2HB033	53	F026B3CD033	54	F026B3GA033	52	F026B4BB033	53	F026B4ED033
54	F026B2HD001	53	F026B3DA001	54	F026B3GB001	52	F026B4BD001	54	F026B4FA001
54	F026B2HD006	53	F026B3DA006	54	F026B3GB006	52	F026B4BD006	54	F026B4FA006
54	F026B2HD012	53	F026B3DA012	54	F026B3GB012	52	F026B4BD012	54	F026B4FA012
54	F026B2HD018	53	F026B3DA018	54	F026B3GB018	52	F026B4BD018	54	F026B4FA018
54	F026B2HD030	53	F026B3DA030	54	F026B3GB030	52	F026B4BD030	54	F026B4FA030
54	F026B2HD033	53	F026B3DA033	54	F026B3GB033	52	F026B4BD033	54	F026B4FA033
52	F026B3AA001	53	F026B3DB001	54	F026B3GD001	53	F026B4CA001	54	F026B4FB001
52	F026B3AA006	53	F026B3DB006	54	F026B3GD006	53	F026B4CA006	54	F026B4FB006
52	F026B3AA012	53	F026B3DB012	54	F026B3GD012	53	F026B4CA012	54	F026B4FB012
52	F026B3AA018	53	F026B3DB018	54	F026B3GD018	53	F026B4CA018	54	F026B4FB018
52	F026B3AA030	53	F026B3DB030	54	F026B3GD030	53	F026B4CA030	54	F026B4FB030
52	F026B3AA033	53	F026B3DB033	54	F026B3GD033	53	F026B4CA033	54	F026B4FB033
52	F026B3AB001	53	F026B3DD001	54	F026B3HA001	53	F026B4CB001	54	F026B4FD001
52	F026B3AB006	53	F026B3DD006	54	F026B3HA006	53	F026B4CB006	54	F026B4FD006
52	F026B3AB012	53	F026B3DD012	54	F026B3HA012	53	F026B4CB012	54	F026B4FD012
52	F026B3AB018	53	F026B3DD018	54	F026B3HA018	53	F026B4CB018	54	F026B4FD018
52	F026B3AB030	53	F026B3DD030	54	F026B3HA030	53	F026B4CB030	54	F026B4FD030
52	F026B3AB033	53	F026B3DD033	54	F026B3HA033	53	F026B4CB033	54	F026B4FD033
52	F026B3AD001	53	F026B3EA001	54	F026B3HB001	53	F026B4CD001	54	F026B4GA001
52	F026B3AD006	53	F026B3EA006	54	F026B3HB006	53	F026B4CD006	54	F026B4GA006
52	F026B3AD012	53	F026B3EA012	54	F026B3HB012	53	F026B4CD012	54	F026B4GA012
52	F026B3AD018	53	F026B3EA018	54	F026B3HB018	53	F026B4CD018	54	F026B4GA018
52	F026B3AD030	53	F026B3EA030	54	F026B3HB030	53	F026B4CD030	54	F026B4GA030
52	F026B3AD033	53	F026B3EA033	54	F026B3HB033	53	F026B4CD033	54	F026B4GA033
52	F026B3BA001	53	F026B3EB001	54	F026B3HD001	53	F026B4DA001	54	F026B4GB001
52	F026B3BA006	53	F026B3EB006	54	F026B3HD006	53	F026B4DA006	54	F026B4GB006
52	F026B3BA012	53	F026B3EB012	54	F026B3HD012	53	F026B4DA012	54	F026B4GB012
52	F026B3BA018	53	F026B3EB018	54	F026B3HD018	53	F026B4DA018	54	F026B4GB018
52	F026B3BA030	53	F026B3EB030	54	F026B3HD030	53	F026B4DA030	54	F026B4GB030
52	F026B3BA033	53	F026B3EB033	54	F026B3HD033	53	F026B4DA033	54	F026B4GB033
52	F026B3BB001	53	F026B3ED001	52	F026B4AA001	53	F026B4DB001	54	F026B4GD001
52	F026B3BB006	53	F026B3ED006	52	F026B4AA006	53	F026B4DB006	54	F026B4GD006
52	F026B3BB012	53	F026B3ED012	52	F026B4AA012	53	F026B4DB012	54	F026B4GD012
52	F026B3BB018	53	F026B3ED018	52	F026B4AA018	53	F026B4DB018	54	F026B4GD018
52	F026B3BB030	53	F026B3ED030	52	F026B4AA030	53	F026B4DB030	54	F026B4GD030
52	F026B3BB033	53	F026B3ED033	52	F026B4AA033	53	F026B4DB033	54	F026B4GD033
52	F026B3BD001	54	F026B3FA001	52	F026B4AB001	53	F026B4DD001	54	F026B4HA001
52	F026B3BD006	54	F026B3FA006	52	F026B4AB006	53	F026B4DD006	54	F026B4HA006
52	F026B3BD012	54	F026B3FA012	52	F026B4AB012	53	F026B4DD012	54	F026B4HA012
52	F026B3BD018	54	F026B3FA018	52	F026B4AB018	53	F026B4DD018	54	F026B4HA018
52	F026B3BD030	54	F026B3FA030	52	F026B4AB030	53	F026B4DD030	54	F026B4HA030

Page	Reference	Page	Reference	Page	Reference	Page	Reference	Page	Reference
54	F026B4HA033	56	F026C2DB033	57	F026C2GD033	56	F026C3DA033	57	F026C3GB033
54	F026B4HB001	56	F026C2DD001	57	F026C2HA001	56	F026C3DB001	57	F026C3GD001
54	F026B4HB006	56	F026C2DD006	57	F026C2HA006	56	F026C3DB006	57	F026C3GD006
54	F026B4HB012	56	F026C2DD012	57	F026C2HA012	56	F026C3DB012	57	F026C3GD012
54	F026B4HB018	56	F026C2DD018	57	F026C2HA018	56	F026C3DB018	57	F026C3GD018
54	F026B4HB030	56	F026C2DD030	57	F026C2HA030	56	F026C3DB030	57	F026C3GD030
54	F026B4HB033	56	F026C2DD033	57	F026C2HA033	56	F026C3DB033	57	F026C3GD033
54	F026B4HD001	56	F026C2EA001	57	F026C2HB001	56	F026C3DD001	57	F026C3HA001
54	F026B4HD006	56	F026C2EA006	57	F026C2HB006	56	F026C3DD006	57	F026C3HA006
54	F026B4HD012	56	F026C2EA012	57	F026C2HB012	56	F026C3DD012	57	F026C3HA012
54	F026B4HD018	56	F026C2EA018	57	F026C2HB018	56	F026C3DD018	57	F026C3HA018
54	F026B4HD030	56	F026C2EA030	57	F026C2HB030	56	F026C3DD030	57	F026C3HA030
54	F026B4HD033	56	F026C2EA033	57	F026C2HB033	56	F026C3DD033	57	F026C3HA033
55	F026C2BA001	56	F026C2EB001	57	F026C2HD001	56	F026C3EA001	57	F026C3HB001
55	F026C2BA006	56	F026C2EB006	57	F026C2HD006	56	F026C3EA006	57	F026C3HB006
55	F026C2BA012	56	F026C2EB012	57	F026C2HD012	56	F026C3EA012	57	F026C3HB012
55	F026C2BA018	56	F026C2EB018	57	F026C2HD018	56	F026C3EA018	57	F026C3HB018
55	F026C2BA030	56	F026C2EB030	57	F026C2HD030	56	F026C3EA030	57	F026C3HB030
55	F026C2BA033	56	F026C2EB033	57	F026C2HD033	56	F026C3EA033	57	F026C3HB033
55	F026C2BB001	56	F026C2ED001	55	F026C3BA001	56	F026C3EB001	57	F026C3HD001
55	F026C2BB006	56	F026C2ED006	55	F026C3BA006	56	F026C3EB006	57	F026C3HD006
55	F026C2BB012	56	F026C2ED012	55	F026C3BA012	56	F026C3EB012	57	F026C3HD012
55	F026C2BB018	56	F026C2ED018	55	F026C3BA018	56	F026C3EB018	57	F026C3HD018
55	F026C2BB030	56	F026C2ED030	55	F026C3BA030	56	F026C3EB030	57	F026C3HD030
55	F026C2BB033	56	F026C2ED033	55	F026C3BA033	56	F026C3EB033	57	F026C3HD033
55	F026C2BD001	56	F026C2FA001	55	F026C3BB001	56	F026C3ED001	55	F026C4BA001
55	F026C2BD006	56	F026C2FA006	55	F026C3BB006	56	F026C3ED006	55	F026C4BA006
55	F026C2BD012	56	F026C2FA012	55	F026C3BB012	56	F026C3ED012	55	F026C4BA012
55	F026C2BD018	56	F026C2FA018	55	F026C3BB018	56	F026C3ED018	55	F026C4BA018
55	F026C2BD030	56	F026C2FA030	55	F026C3BB030	56	F026C3ED030	55	F026C4BA030
55	F026C2BD033	56	F026C2FA033	55	F026C3BB033	56	F026C3ED033	55	F026C4BA033
55	F026C2CA001	56	F026C2FB001	55	F026C3BD001	56	F026C3FA001	55	F026C4BB001
55	F026C2CA006	56	F026C2FB006	55	F026C3BD006	56	F026C3FA006	55	F026C4BB006
55	F026C2CA012	56	F026C2FB012	55	F026C3BD012	56	F026C3FA012	55	F026C4BB012
55	F026C2CA018	56	F026C2FB018	55	F026C3BD018	56	F026C3FA018	55	F026C4BB018
55	F026C2CA030	56	F026C2FB030	55	F026C3BD030	56	F026C3FA030	55	F026C4BB030
55	F026C2CA033	56	F026C2FB033	55	F026C3BD033	56	F026C3FA033	55	F026C4BB033
55	F026C2CB001	56	F026C2FD001	55	F026C3CA001	56	F026C3FB001	55	F026C4BD001
55	F026C2CB006	56	F026C2FD006	55	F026C3CA006	56	F026C3FB006	55	F026C4BD006
55	F026C2CB012	56	F026C2FD012	55	F026C3CA012	56	F026C3FB012	55	F026C4BD012
55	F026C2CB018	56	F026C2FD018	55	F026C3CA018	56	F026C3FB018	55	F026C4BD018
55	F026C2CB030	56	F026C2FD030	55	F026C3CA030	56	F026C3FB030	55	F026C4BD030
55	F026C2CB033	56	F026C2FD033	55	F026C3CA033	56	F026C3FB033	55	F026C4BD033
55	F026C2CD001	57	F026C2GA001	55	F026C3CB001	56	F026C3FD001	55	F026C4CA001
55	F026C2CD006	57	F026C2GA006	55	F026C3CB006	56	F026C3FD006	55	F026C4CA006
55	F026C2CD012	57	F026C2GA012	55	F026C3CB012	56	F026C3FD012	55	F026C4CA012
55	F026C2CD018	57	F026C2GA018	55	F026C3CB018	56	F026C3FD018	55	F026C4CA018
55	F026C2CD030	57	F026C2GA030	55	F026C3CB030	56	F026C3FD030	55	F026C4CA030
55	F026C2CD033	57	F026C2GA033	55	F026C3CB033	56	F026C3FD033	55	F026C4CA033
56	F026C2DA001	57	F026C2GB001	55	F026C3CD001	57	F026C3GA001	55	F026C4CB001
56	F026C2DA006	57	F026C2GB006	55	F026C3CD006	57	F026C3GA006	55	F026C4CB006
56	F026C2DA012	57	F026C2GB012	55	F026C3CD012	57	F026C3GA012	55	F026C4CB012
56	F026C2DA018	57	F026C2GB018	55	F026C3CD018	57	F026C3GA018	55	F026C4CB018
56	F026C2DA030	57	F026C2GB030	55	F026C3CD030	57	F026C3GA030	55	F026C4CB030
56	F026C2DA033	57	F026C2GB033	55	F026C3CD033	57	F026C3GA033	55	F026C4CB033
56	F026C2DB001	57	F026C2GD001	56	F026C3DA001	57	F026C3GB001	55	F026C4CD001
56	F026C2DB006	57	F026C2GD006	56	F026C3DA006	57	F026C3GB006	55	F026C4CD006
56	F026C2DB012	57	F026C2GD012	56	F026C3DA012	57	F026C3GB012	55	F026C4CD012
56	F026C2DB018	57	F026C2GD018	56	F026C3DA018	57	F026C3GB018	55	F026C4CD018
56	F026C2DB030	57	F026C2GD030	56	F026C3DA030	57	F026C3GB030	55	F026C4CD030

Page	Reference	Page	Reference	Page	Reference	Page	Reference	Page	Reference
55	F026C4CD033	57	F026C4GA033	42	F026D2BB033	43	F026D2ED033	42	F026D3AA033
56	F026C4DA001	57	F026C4GB001	42	F026D2BD001	44	F026D2FA001	42	F026D3AB001
56	F026C4DA006	57	F026C4GB006	42	F026D2BD006	44	F026D2FA006	42	F026D3AB006
56	F026C4DA012	57	F026C4GB012	42	F026D2BD012	44	F026D2FA012	42	F026D3AB012
56	F026C4DA018	57	F026C4GB018	42	F026D2BD018	44	F026D2FA018	42	F026D3AB018
56	F026C4DA030	57	F026C4GB030	42	F026D2BD030	44	F026D2FA030	42	F026D3AB030
56	F026C4DA033	57	F026C4GB033	42	F026D2BD033	44	F026D2FA033	42	F026D3AB033
56	F026C4DB001	57	F026C4GD001	43	F026D2CA001	44	F026D2FB001	42	F026D3AD001
56	F026C4DB006	57	F026C4GD006	43	F026D2CA006	44	F026D2FB006	42	F026D3AD006
56	F026C4DB012	57	F026C4GD012	43	F026D2CA012	44	F026D2FB012	42	F026D3AD012
56	F026C4DB018	57	F026C4GD018	43	F026D2CA018	44	F026D2FB018	42	F026D3AD018
56	F026C4DB030	57	F026C4GD030	43	F026D2CA030	44	F026D2FB030	42	F026D3AD030
56	F026C4DB033	57	F026C4GD033	43	F026D2CA033	44	F026D2FB033	42	F026D3AD033
56	F026C4DD001	57	F026C4HA001	43	F026D2CB001	44	F026D2FD001	42	F026D3BA001
56	F026C4DD006	57	F026C4HA006	43	F026D2CB006	44	F026D2FD006	42	F026D3BA006
56	F026C4DD012	57	F026C4HA012	43	F026D2CB012	44	F026D2FD012	42	F026D3BA012
56	F026C4DD018	57	F026C4HA018	43	F026D2CB018	44	F026D2FD018	42	F026D3BA018
56	F026C4DD030	57	F026C4HA030	43	F026D2CB030	44	F026D2FD030	42	F026D3BA030
56	F026C4DD033	57	F026C4HA033	43	F026D2CB033	44	F026D2FD033	42	F026D3BA033
56	F026C4EA001	57	F026C4HB001	43	F026D2CD001	44	F026D2GA001	42	F026D3BB001
56	F026C4EA006	57	F026C4HB006	43	F026D2CD006	44	F026D2GA006	42	F026D3BB006
56	F026C4EA012	57	F026C4HB012	43	F026D2CD012	44	F026D2GA012	42	F026D3BB012
56	F026C4EA018	57	F026C4HB018	43	F026D2CD018	44	F026D2GA018	42	F026D3BB018
56	F026C4EA030	57	F026C4HB030	43	F026D2CD030	44	F026D2GA030	42	F026D3BB030
56	F026C4EA033	57	F026C4HB033	43	F026D2CD033	44	F026D2GA033	42	F026D3BB033
56	F026C4EB001	57	F026C4HD001	43	F026D2DA001	44	F026D2GB001	42	F026D3BD001
56	F026C4EB006	57	F026C4HD006	43	F026D2DA006	44	F026D2GB006	42	F026D3BD006
56	F026C4EB012	57	F026C4HD012	43	F026D2DA012	44	F026D2GB012	42	F026D3BD012
56	F026C4EB018	57	F026C4HD018	43	F026D2DA018	44	F026D2GB018	42	F026D3BD018
56	F026C4EB030	57	F026C4HD030	43	F026D2DA030	44	F026D2GB030	42	F026D3BD030
56	F026C4EB033	57	F026C4HD033	43	F026D2DA033	44	F026D2GB033	42	F026D3BD033
56	F026C4ED001	42	F026D2AA001	43	F026D2DB001	44	F026D2GD001	43	F026D3CA001
56	F026C4ED006	42	F026D2AA006	43	F026D2DB006	44	F026D2GD006	43	F026D3CA006
56	F026C4ED012	42	F026D2AA012	43	F026D2DB012	44	F026D2GD012	43	F026D3CA012
56	F026C4ED018	42	F026D2AA018	43	F026D2DB018	44	F026D2GD018	43	F026D3CA018
56	F026C4ED030	42	F026D2AA030	43	F026D2DB030	44	F026D2GD030	43	F026D3CA030
56	F026C4ED033	42	F026D2AA033	43	F026D2DB033	44	F026D2GD033	43	F026D3CA033
56	F026C4FA001	42	F026D2AB001	43	F026D2DD001	44	F026D2HA001	43	F026D3CB001
56	F026C4FA006	42	F026D2AB006	43	F026D2DD006	44	F026D2HA006	43	F026D3CB006
56	F026C4FA012	42	F026D2AB012	43	F026D2DD012	44	F026D2HA012	43	F026D3CB012
56	F026C4FA018	42	F026D2AB018	43	F026D2DD018	44	F026D2HA018	43	F026D3CB018
56	F026C4FA030	42	F026D2AB030	43	F026D2DD030	44	F026D2HA030	43	F026D3CB030
56	F026C4FA033	42	F026D2AB033	43	F026D2DD033	44	F026D2HA033	43	F026D3CB033
56	F026C4FB001	42	F026D2AD001	43	F026D2EA001	44	F026D2HB001	43	F026D3CD001
56	F026C4FB006	42	F026D2AD006	43	F026D2EA006	44	F026D2HB006	43	F026D3CD006
56	F026C4FB012	42	F026D2AD012	43	F026D2EA012	44	F026D2HB012	43	F026D3CD012
56	F026C4FB018	42	F026D2AD018	43	F026D2EA018	44	F026D2HB018	43	F026D3CD018
56	F026C4FB030	42	F026D2AD030	43	F026D2EA030	44	F026D2HB030	43	F026D3CD030
56	F026C4FB033	42	F026D2AD033	43	F026D2EA033	44	F026D2HB033	43	F026D3CD033
56	F026C4FD001	42	F026D2BA001	43	F026D2EB001	44	F026D2HD001	43	F026D3DA001
56	F026C4FD006	42	F026D2BA006	43	F026D2EB006	44	F026D2HD006	43	F026D3DA006
56	F026C4FD012	42	F026D2BA012	43	F026D2EB012	44	F026D2HD012	43	F026D3DA012
56	F026C4FD018	42	F026D2BA018	43	F026D2EB018	44	F026D2HD018	43	F026D3DA018
56	F026C4FD030	42	F026D2BA030	43	F026D2EB030	44	F026D2HD030	43	F026D3DA030
56	F026C4FD033	42	F026D2BA033	43	F026D2EB033	44	F026D2HD033	43	F026D3DA033
57	F026C4GA001	42	F026D2BB001	43	F026D2ED001	42	F026D3AA001	43	F026D3DB001
57	F026C4GA006	42	F026D2BB006	43	F026D2ED006	42	F026D3AA006	43	F026D3DB006
57	F026C4GA012	42	F026D2BB012	43	F026D2ED012	42	F026D3AA012	43	F026D3DB012
57	F026C4GA018	42	F026D2BB018	43	F026D2ED018	42	F026D3AA018	43	F026D3DB018
57	F026C4GA030	42	F026D2BB030	43	F026D2ED030	42	F026D3AA030	43	F026D3DB030

Page	Reference	Page	Reference	Page	Reference	Page	Reference	Page	Reference
46	F026E2FA033	45	F026E3BB033	46	F026E3ED033	45	F026E4BA033	46	F026E4EB033
46	F026E2FB001	45	F026E3BD001	46	F026E3FA001	45	F026E4BB001	46	F026E4ED001
46	F026E2FB006	45	F026E3BD006	46	F026E3FA006	45	F026E4BB006	46	F026E4ED006
46	F026E2FB012	45	F026E3BD012	46	F026E3FA012	45	F026E4BB012	46	F026E4ED012
46	F026E2FB018	45	F026E3BD018	46	F026E3FA018	45	F026E4BB018	46	F026E4ED018
46	F026E2FB030	45	F026E3BD030	46	F026E3FA030	45	F026E4BB030	46	F026E4ED030
46	F026E2FB033	45	F026E3BD033	46	F026E3FA033	45	F026E4BB033	46	F026E4ED033
46	F026E2FD001	45	F026E3CA001	46	F026E3FB001	45	F026E4BD001	46	F026E4FA001
46	F026E2FD006	45	F026E3CA006	46	F026E3FB006	45	F026E4BD006	46	F026E4FA006
46	F026E2FD012	45	F026E3CA012	46	F026E3FB012	45	F026E4BD012	46	F026E4FA012
46	F026E2FD018	45	F026E3CA018	46	F026E3FB018	45	F026E4BD018	46	F026E4FA018
46	F026E2FD030	45	F026E3CA030	46	F026E3FB030	45	F026E4BD030	46	F026E4FA030
46	F026E2FD033	45	F026E3CA033	46	F026E3FB033	45	F026E4BD033	46	F026E4FA033
47	F026E2GA001	45	F026E3CB001	46	F026E3FD001	45	F026E4CA001	46	F026E4FB001
47	F026E2GA006	45	F026E3CB006	46	F026E3FD006	45	F026E4CA006	46	F026E4FB006
47	F026E2GA012	45	F026E3CB012	46	F026E3FD012	45	F026E4CA012	46	F026E4FB012
47	F026E2GA018	45	F026E3CB018	46	F026E3FD018	45	F026E4CA018	46	F026E4FB018
47	F026E2GA030	45	F026E3CB030	46	F026E3FD030	45	F026E4CA030	46	F026E4FB030
47	F026E2GA033	45	F026E3CB033	46	F026E3FD033	45	F026E4CA033	46	F026E4FB033
47	F026E2GB001	45	F026E3CD001	47	F026E3GA001	45	F026E4CB001	46	F026E4FD001
47	F026E2GB006	45	F026E3CD006	47	F026E3GA006	45	F026E4CB006	46	F026E4FD006
47	F026E2GB012	45	F026E3CD012	47	F026E3GA012	45	F026E4CB012	46	F026E4FD012
47	F026E2GB018	45	F026E3CD018	47	F026E3GA018	45	F026E4CB018	46	F026E4FD018
47	F026E2GB030	45	F026E3CD030	47	F026E3GA030	45	F026E4CB030	46	F026E4FD030
47	F026E2GB033	45	F026E3CD033	47	F026E3GA033	45	F026E4CB033	46	F026E4FD033
47	F026E2GD001	46	F026E3DA001	47	F026E3GB001	45	F026E4CD001	47	F026E4GA001
47	F026E2GD006	46	F026E3DA006	47	F026E3GB006	45	F026E4CD006	47	F026E4GA006
47	F026E2GD012	46	F026E3DA012	47	F026E3GB012	45	F026E4CD012	47	F026E4GA012
47	F026E2GD018	46	F026E3DA018	47	F026E3GB018	45	F026E4CD018	47	F026E4GA018
47	F026E2GD030	46	F026E3DA030	47	F026E3GB030	45	F026E4CD030	47	F026E4GA030
47	F026E2GD033	46	F026E3DA033	47	F026E3GB033	45	F026E4CD033	47	F026E4GA033
47	F026E2HA001	46	F026E3DB001	47	F026E3GD001	46	F026E4DA001	47	F026E4GB001
47	F026E2HA006	46	F026E3DB006	47	F026E3GD006	46	F026E4DA006	47	F026E4GB006
47	F026E2HA012	46	F026E3DB012	47	F026E3GD012	46	F026E4DA012	47	F026E4GB012
47	F026E2HA018	46	F026E3DB018	47	F026E3GD018	46	F026E4DA018	47	F026E4GB018
47	F026E2HA030	46	F026E3DB030	47	F026E3GD030	46	F026E4DA030	47	F026E4GB030
47	F026E2HA033	46	F026E3DB033	47	F026E3GD033	46	F026E4DA033	47	F026E4GB033
47	F026E2HB001	46	F026E3DD001	47	F026E3HA001	46	F026E4DB001	47	F026E4GD001
47	F026E2HB006	46	F026E3DD006	47	F026E3HA006	46	F026E4DB006	47	F026E4GD006
47	F026E2HB012	46	F026E3DD012	47	F026E3HA012	46	F026E4DB012	47	F026E4GD012
47	F026E2HB018	46	F026E3DD018	47	F026E3HA018	46	F026E4DB018	47	F026E4GD018
47	F026E2HB030	46	F026E3DD030	47	F026E3HA030	46	F026E4DB030	47	F026E4GD030
47	F026E2HB033	46	F026E3DD033	47	F026E3HA033	46	F026E4DB033	47	F026E4GD033
47	F026E2HD001	46	F026E3EA001	47	F026E3HB001	46	F026E4DD001	47	F026E4HA001
47	F026E2HD006	46	F026E3EA006	47	F026E3HB006	46	F026E4DD006	47	F026E4HA006
47	F026E2HD012	46	F026E3EA012	47	F026E3HB012	46	F026E4DD012	47	F026E4HA012
47	F026E2HD018	46	F026E3EA018	47	F026E3HB018	46	F026E4DD018	47	F026E4HA018
47	F026E2HD030	46	F026E3EA030	47	F026E3HB030	46	F026E4DD030	47	F026E4HA030
47	F026E2HD033	46	F026E3EA033	47	F026E3HB033	46	F026E4DD033	47	F026E4HA033
45	F026E3BA001	46	F026E3EB001	47	F026E3HD001	46	F026E4EA001	47	F026E4HB001
45	F026E3BA006	46	F026E3EB006	47	F026E3HD006	46	F026E4EA006	47	F026E4HB006
45	F026E3BA012	46	F026E3EB012	47	F026E3HD012	46	F026E4EA012	47	F026E4HB012
45	F026E3BA018	46	F026E3EB018	47	F026E3HD018	46	F026E4EA018	47	F026E4HB018
45	F026E3BA030	46	F026E3EB030	47	F026E3HD030	46	F026E4EA030	47	F026E4HB030
45	F026E3BA033	46	F026E3EB033	47	F026E3HD033	46	F026E4EA033	47	F026E4HB033
45	F026E3BB001	46	F026E3ED001	45	F026E4BA001	46	F026E4EB001	47	F026E4HD001
45	F026E3BB006	46	F026E3ED006	45	F026E4BA006	46	F026E4EB006	47	F026E4HD006
45	F026E3BB012	46	F026E3ED012	45	F026E4BA012	46	F026E4EB012	47	F026E4HD012
45	F026E3BB018	46	F026E3ED018	45	F026E4BA018	46	F026E4EB018	47	F026E4HD018
45	F026E3BB030	46	F026E3ED030	45	F026E4BA030	46	F026E4EB030	47	F026E4HD030

Page	Reference	Page	Reference	Page	Reference	Page	Reference	Page	Reference
47	F026E4HD033	67	F026F3CA033	86	F026G2AB033	87	F026G2DD033	88	F026G2HA033
67	F026F2BA001.A	67	F026F3CB001	86	F026G2AD001	87	F026G2EA001	88	F026G2HB001
67	F026F2BA006.A	67	F026F3CB006	86	F026G2AD006	87	F026G2EA006	88	F026G2HB006
67	F026F2BA012.A	67	F026F3CB012	86	F026G2AD012	87	F026G2EA012	88	F026G2HB012
67	F026F2BA018.A	67	F026F3CB018	86	F026G2AD018	87	F026G2EA018	88	F026G2HB018
67	F026F2BA030.A	67	F026F3CB030	86	F026G2AD030	87	F026G2EA030	88	F026G2HB030
67	F026F2BA033.A	67	F026F3CB033	86	F026G2AD033	87	F026G2EA033	88	F026G2HB033
67	F026F2BB001.A	67	F026F3CD001	86	F026G2BA001	87	F026G2EB001	88	F026G2HD001
67	F026F2BB006.A	67	F026F3CD006	86	F026G2BA006	87	F026G2EB006	88	F026G2HD006
67	F026F2BB012.A	67	F026F3CD012	86	F026G2BA012	87	F026G2EB012	88	F026G2HD012
67	F026F2BB018.A	67	F026F3CD018	86	F026G2BA018	87	F026G2EB018	88	F026G2HD018
67	F026F2BB030.A	67	F026F3CD030	86	F026G2BA030	87	F026G2EB030	88	F026G2HD030
67	F026F2BB033.A	67	F026F3CD033	86	F026G2BA033	87	F026G2EB033	88	F026G2HD033
67	F026F2BD001.A	67	F026F4BA001.A	86	F026G2BB001	87	F026G2ED001	86	F026G3AA001
67	F026F2BD006.A	67	F026F4BA006.A	86	F026G2BB006	87	F026G2ED006	86	F026G3AA006
67	F026F2BD012.A	67	F026F4BA012.A	86	F026G2BB012	87	F026G2ED012	86	F026G3AA012
67	F026F2BD018.A	67	F026F4BA018.A	86	F026G2BB018	87	F026G2ED018	86	F026G3AA018
67	F026F2BD030.A	67	F026F4BA030.A	86	F026G2BB030	87	F026G2ED030	86	F026G3AA030
67	F026F2BD033.A	67	F026F4BA033.A	86	F026G2BB033	87	F026G2ED033	86	F026G3AA033
67	F026F2CA001.A	67	F026F4BB001.A	86	F026G2BD001	88	F026G2FA001	86	F026G3AB001
67	F026F2CA006.A	67	F026F4BB006.A	86	F026G2BD006	88	F026G2FA006	86	F026G3AB006
67	F026F2CA012.A	67	F026F4BB012.A	86	F026G2BD012	88	F026G2FA012	86	F026G3AB012
67	F026F2CA018.A	67	F026F4BB018.A	86	F026G2BD018	88	F026G2FA018	86	F026G3AB018
67	F026F2CA030.A	67	F026F4BB030.A	86	F026G2BD030	88	F026G2FA030	86	F026G3AB030
67	F026F2CA033.A	67	F026F4BB033.A	86	F026G2BD033	88	F026G2FA033	86	F026G3AB033
67	F026F2CB001.A	67	F026F4BD001.A	87	F026G2CA001	88	F026G2FB001	86	F026G3AD001
67	F026F2CB006.A	67	F026F4BD006.A	87	F026G2CA006	88	F026G2FB006	86	F026G3AD006
67	F026F2CB012.A	67	F026F4BD012.A	87	F026G2CA012	88	F026G2FB012	86	F026G3AD012
67	F026F2CB018.A	67	F026F4BD018.A	87	F026G2CA018	88	F026G2FB018	86	F026G3AD018
67	F026F2CB030.A	67	F026F4BD030.A	87	F026G2CA030	88	F026G2FB030	86	F026G3AD030
67	F026F2CB033.A	67	F026F4BD033.A	87	F026G2CA033	88	F026G2FB033	86	F026G3AD033
67	F026F2CD001.A	67	F026F4CA001.A	87	F026G2CB001	88	F026G2FD001	86	F026G3BA001
67	F026F2CD006.A	67	F026F4CA006.A	87	F026G2CB006	88	F026G2FD006	86	F026G3BA006
67	F026F2CD012.A	67	F026F4CA012.A	87	F026G2CB012	88	F026G2FD012	86	F026G3BA012
67	F026F2CD018.A	67	F026F4CA018.A	87	F026G2CB018	88	F026G2FD018	86	F026G3BA018
67	F026F2CD030.A	67	F026F4CA030.A	87	F026G2CB030	88	F026G2FD030	86	F026G3BA030
67	F026F2CD033.A	67	F026F4CA033.A	87	F026G2CB033	88	F026G2FD033	86	F026G3BA033
67	F026F3BA001	67	F026F4CB001.A	87	F026G2CD001	88	F026G2GA001	86	F026G3BB001
67	F026F3BA006	67	F026F4CB006.A	87	F026G2CD006	88	F026G2GA006	86	F026G3BB006
67	F026F3BA012	67	F026F4CB012.A	87	F026G2CD012	88	F026G2GA012	86	F026G3BB012
67	F026F3BA018	67	F026F4CB018.A	87	F026G2CD018	88	F026G2GA018	86	F026G3BB018
67	F026F3BA030	67	F026F4CB030.A	87	F026G2CD030	88	F026G2GA030	86	F026G3BB030
67	F026F3BA033	67	F026F4CB033.A	87	F026G2CD033	88	F026G2GA033	86	F026G3BB033
67	F026F3BB001	67	F026F4CD001.A	87	F026G2DA001	88	F026G2GB001	86	F026G3BD001
67	F026F3BB006	67	F026F4CD006.A	87	F026G2DA006	88	F026G2GB006	86	F026G3BD006
67	F026F3BB012	67	F026F4CD012.A	87	F026G2DA012	88	F026G2GB012	86	F026G3BD012
67	F026F3BB018	67	F026F4CD018.A	87	F026G2DA018	88	F026G2GB018	86	F026G3BD018
67	F026F3BB030	67	F026F4CD030.A	87	F026G2DA030	88	F026G2GB030	86	F026G3BD030
67	F026F3BB033	67	F026F4CD033.A	87	F026G2DA033	88	F026G2GB033	86	F026G3BD033
67	F026F3BD001	86	F026G2AA001	87	F026G2DB001	88	F026G2GD001	87	F026G3CA001
67	F026F3BD006	86	F026G2AA006	87	F026G2DB006	88	F026G2GD006	87	F026G3CA006
67	F026F3BD012	86	F026G2AA012	87	F026G2DB012	88	F026G2GD012	87	F026G3CA012
67	F026F3BD018	86	F026G2AA018	87	F026G2DB018	88	F026G2GD018	87	F026G3CA018
67	F026F3BD030	86	F026G2AA030	87	F026G2DB030	88	F026G2GD030	87	F026G3CA030
67	F026F3BD033	86	F026G2AA033	87	F026G2DB033	88	F026G2GD033	87	F026G3CA033
67	F026F3CA001	86	F026G2AB001	87	F026G2DD001	88	F026G2HA001	87	F026G3CB001
67	F026F3CA006	86	F026G2AB006	87	F026G2DD006	88	F026G2HA006	87	F026G3CB006
67	F026F3CA012	86	F026G2AB012	87	F026G2DD012	88	F026G2HA012	87	F026G3CB012
67	F026F3CA018	86	F026G2AB018	87	F026G2DD018	88	F026G2HA018	87	F026G3CB018
67	F026F3CA030	86	F026G2AB030	87	F026G2DD030	88	F026G2HA030	87	F026G3CB030

Page	Reference	Page	Reference	Page	Reference	Page	Reference	Page	Reference
87	F026G3CB033	88	F026G3FD033	86	F026G4BA033	87	F026G4EB033	88	F026G4HD033
87	F026G3CD001	88	F026G3GA001	86	F026G4BB001	87	F026G4ED001	89	F026H2BA001
87	F026G3CD006	88	F026G3GA006	86	F026G4BB006	87	F026G4ED006	89	F026H2BA006
87	F026G3CD012	88	F026G3GA012	86	F026G4BB012	87	F026G4ED012	89	F026H2BA012
87	F026G3CD018	88	F026G3GA018	86	F026G4BB018	87	F026G4ED018	89	F026H2BA018
87	F026G3CD030	88	F026G3GA030	86	F026G4BB030	87	F026G4ED030	89	F026H2BA030
87	F026G3CD033	88	F026G3GA033	86	F026G4BB033	87	F026G4ED033	89	F026H2BA033
87	F026G3DA001	88	F026G3GB001	86	F026G4BD001	88	F026G4FA001	89	F026H2BB001
87	F026G3DA006	88	F026G3GB006	86	F026G4BD006	88	F026G4FA006	89	F026H2BB006
87	F026G3DA012	88	F026G3GB012	86	F026G4BD012	88	F026G4FA012	89	F026H2BB012
87	F026G3DA018	88	F026G3GB018	86	F026G4BD018	88	F026G4FA018	89	F026H2BB018
87	F026G3DA030	88	F026G3GB030	86	F026G4BD030	88	F026G4FA030	89	F026H2BB030
87	F026G3DA033	88	F026G3GB033	86	F026G4BD033	88	F026G4FA033	89	F026H2BB033
87	F026G3DB001	88	F026G3GD001	87	F026G4CA001	88	F026G4FB001	89	F026H2BD001
87	F026G3DB006	88	F026G3GD006	87	F026G4CA006	88	F026G4FB006	89	F026H2BD006
87	F026G3DB012	88	F026G3GD012	87	F026G4CA012	88	F026G4FB012	89	F026H2BD012
87	F026G3DB018	88	F026G3GD018	87	F026G4CA018	88	F026G4FB018	89	F026H2BD018
87	F026G3DB030	88	F026G3GD030	87	F026G4CA030	88	F026G4FB030	89	F026H2BD030
87	F026G3DB033	88	F026G3GD033	87	F026G4CA033	88	F026G4FB033	89	F026H2BD033
87	F026G3DD001	88	F026G3HA001	87	F026G4CB001	88	F026G4FD001	89	F026H2CA001
87	F026G3DD006	88	F026G3HA006	87	F026G4CB006	88	F026G4FD006	89	F026H2CA006
87	F026G3DD012	88	F026G3HA012	87	F026G4CB012	88	F026G4FD012	89	F026H2CA012
87	F026G3DD018	88	F026G3HA018	87	F026G4CB018	88	F026G4FD018	89	F026H2CA018
87	F026G3DD030	88	F026G3HA030	87	F026G4CB030	88	F026G4FD030	89	F026H2CA030
87	F026G3DD033	88	F026G3HA033	87	F026G4CB033	88	F026G4FD033	89	F026H2CA033
87	F026G3EA001	88	F026G3HB001	87	F026G4CD001	88	F026G4GA001	89	F026H2CB001
87	F026G3EA006	88	F026G3HB006	87	F026G4CD006	88	F026G4GA006	89	F026H2CB006
87	F026G3EA012	88	F026G3HB012	87	F026G4CD012	88	F026G4GA012	89	F026H2CB012
87	F026G3EA018	88	F026G3HB018	87	F026G4CD018	88	F026G4GA018	89	F026H2CB018
87	F026G3EA030	88	F026G3HB030	87	F026G4CD030	88	F026G4GA030	89	F026H2CB030
87	F026G3EA033	88	F026G3HB033	87	F026G4CD033	88	F026G4GA033	89	F026H2CB033
87	F026G3EB001	88	F026G3HD001	87	F026G4DA001	88	F026G4GB001	89	F026H2CD001
87	F026G3EB006	88	F026G3HD006	87	F026G4DA006	88	F026G4GB006	89	F026H2CD006
87	F026G3EB012	88	F026G3HD012	87	F026G4DA012	88	F026G4GB012	89	F026H2CD012
87	F026G3EB018	88	F026G3HD018	87	F026G4DA018	88	F026G4GB018	89	F026H2CD018
87	F026G3EB030	88	F026G3HD030	87	F026G4DA030	88	F026G4GB030	89	F026H2CD030
87	F026G3EB033	88	F026G3HD033	87	F026G4DA033	88	F026G4GB033	89	F026H2CD033
87	F026G3ED001	86	F026G4AA001	87	F026G4DB001	88	F026G4GD001	90	F026H2DA001
87	F026G3ED006	86	F026G4AA006	87	F026G4DB006	88	F026G4GD006	90	F026H2DA006
87	F026G3ED012	86	F026G4AA012	87	F026G4DB012	88	F026G4GD012	90	F026H2DA012
87	F026G3ED018	86	F026G4AA018	87	F026G4DB018	88	F026G4GD018	90	F026H2DA018
87	F026G3ED030	86	F026G4AA030	87	F026G4DB030	88	F026G4GD030	90	F026H2DA030
87	F026G3ED033	86	F026G4AA033	87	F026G4DB033	88	F026G4GD033	90	F026H2DA033
88	F026G3FA001	86	F026G4AB001	87	F026G4DD001	88	F026G4HA001	90	F026H2DB001
88	F026G3FA006	86	F026G4AB006	87	F026G4DD006	88	F026G4HA006	90	F026H2DB006
88	F026G3FA012	86	F026G4AB012	87	F026G4DD012	88	F026G4HA012	90	F026H2DB012
88	F026G3FA018	86	F026G4AB018	87	F026G4DD018	88	F026G4HA018	90	F026H2DB018
88	F026G3FA030	86	F026G4AB030	87	F026G4DD030	88	F026G4HA030	90	F026H2DB030
88	F026G3FA033	86	F026G4AB033	87	F026G4DD033	88	F026G4HA033	90	F026H2DB033
88	F026G3FB001	86	F026G4AD001	87	F026G4EA001	88	F026G4HB001	90	F026H2DD001
88	F026G3FB006	86	F026G4AD006	87	F026G4EA006	88	F026G4HB006	90	F026H2DD006
88	F026G3FB012	86	F026G4AD012	87	F026G4EA012	88	F026G4HB012	90	F026H2DD012
88	F026G3FB018	86	F026G4AD018	87	F026G4EA018	88	F026G4HB018	90	F026H2DD018
88	F026G3FB030	86	F026G4AD030	87	F026G4EA030	88	F026G4HB030	90	F026H2DD030
88	F026G3FB033	86	F026G4AD033	87	F026G4EA033	88	F026G4HB033	90	F026H2DD033
88	F026G3FD001	86	F026G4BA001	87	F026G4EB001	88	F026G4HD001	90	F026H2EA001
88	F026G3FD006	86	F026G4BA006	87	F026G4EB006	88	F026G4HD006	90	F026H2EA006
88	F026G3FD012	86	F026G4BA012	87	F026G4EB012	88	F026G4HD012	90	F026H2EA012
88	F026G3FD018	86	F026G4BA018	87	F026G4EB018	88	F026G4HD018	90	F026H2EA018
88	F026G3FD030	86	F026G4BA030	87	F026G4EB030	88	F026G4HD030	90	F026H2EA030

Page	Reference	Page	Reference	Page	Reference	Page	Reference	Page	Reference
90	F026H2EA033	91	F026H2HB033	90	F026H3DD033	91	F026H3HA033	90	F026H4DB033
90	F026H2EB001	91	F026H2HD001	90	F026H3EA001	91	F026H3HB001	90	F026H4DD001
90	F026H2EB006	91	F026H2HD006	90	F026H3EA006	91	F026H3HB006	90	F026H4DD006
90	F026H2EB012	91	F026H2HD012	90	F026H3EA012	91	F026H3HB012	90	F026H4DD012
90	F026H2EB018	91	F026H2HD018	90	F026H3EA018	91	F026H3HB018	90	F026H4DD018
90	F026H2EB030	91	F026H2HD030	90	F026H3EA030	91	F026H3HB030	90	F026H4DD030
90	F026H2EB033	91	F026H2HD033	90	F026H3EA033	91	F026H3HB033	90	F026H4DD033
90	F026H2ED001	89	F026H3BA001	90	F026H3EB001	91	F026H3HD001	90	F026H4EA001
90	F026H2ED006	89	F026H3BA006	90	F026H3EB006	91	F026H3HD006	90	F026H4EA006
90	F026H2ED012	89	F026H3BA012	90	F026H3EB012	91	F026H3HD012	90	F026H4EA012
90	F026H2ED018	89	F026H3BA018	90	F026H3EB018	91	F026H3HD018	90	F026H4EA018
90	F026H2ED030	89	F026H3BA030	90	F026H3EB030	91	F026H3HD030	90	F026H4EA030
90	F026H2ED033	89	F026H3BA033	90	F026H3EB033	91	F026H3HD033	90	F026H4EA033
90	F026H2FA001	89	F026H3BB001	90	F026H3ED001	89	F026H4BA001	90	F026H4EB001
90	F026H2FA006	89	F026H3BB006	90	F026H3ED006	89	F026H4BA006	90	F026H4EB006
90	F026H2FA012	89	F026H3BB012	90	F026H3ED012	89	F026H4BA012	90	F026H4EB012
90	F026H2FA018	89	F026H3BB018	90	F026H3ED018	89	F026H4BA018	90	F026H4EB018
90	F026H2FA030	89	F026H3BB030	90	F026H3ED030	89	F026H4BA030	90	F026H4EB030
90	F026H2FA033	89	F026H3BB033	90	F026H3ED033	89	F026H4BA033	90	F026H4EB033
90	F026H2FB001	89	F026H3BD001	90	F026H3FA001	89	F026H4BB001	90	F026H4ED001
90	F026H2FB006	89	F026H3BD006	90	F026H3FA006	89	F026H4BB006	90	F026H4ED006
90	F026H2FB012	89	F026H3BD012	90	F026H3FA012	89	F026H4BB012	90	F026H4ED012
90	F026H2FB018	89	F026H3BD018	90	F026H3FA018	89	F026H4BB018	90	F026H4ED018
90	F026H2FB030	89	F026H3BD030	90	F026H3FA030	89	F026H4BB030	90	F026H4ED030
90	F026H2FB033	89	F026H3BD033	90	F026H3FA033	89	F026H4BB033	90	F026H4ED033
90	F026H2FD001	89	F026H3CA001	90	F026H3FB001	89	F026H4BD001	90	F026H4FA001
90	F026H2FD006	89	F026H3CA006	90	F026H3FB006	89	F026H4BD006	90	F026H4FA006
90	F026H2FD012	89	F026H3CA012	90	F026H3FB012	89	F026H4BD012	90	F026H4FA012
90	F026H2FD018	89	F026H3CA018	90	F026H3FB018	89	F026H4BD018	90	F026H4FA018
90	F026H2FD030	89	F026H3CA030	90	F026H3FB030	89	F026H4BD030	90	F026H4FA030
90	F026H2FD033	89	F026H3CA033	90	F026H3FB033	89	F026H4BD033	90	F026H4FA033
91	F026H2GA001	89	F026H3CB001	90	F026H3FD001	89	F026H4CA001	90	F026H4FB001
91	F026H2GA006	89	F026H3CB006	90	F026H3FD006	89	F026H4CA006	90	F026H4FB006
91	F026H2GA012	89	F026H3CB012	90	F026H3FD012	89	F026H4CA012	90	F026H4FB012
91	F026H2GA018	89	F026H3CB018	90	F026H3FD018	89	F026H4CA018	90	F026H4FB018
91	F026H2GA030	89	F026H3CB030	90	F026H3FD030	89	F026H4CA030	90	F026H4FB030
91	F026H2GA033	89	F026H3CB033	90	F026H3FD033	89	F026H4CA033	90	F026H4FB033
91	F026H2GB001	89	F026H3CD001	91	F026H3GA001	89	F026H4CB001	90	F026H4FD001
91	F026H2GB006	89	F026H3CD006	91	F026H3GA006	89	F026H4CB006	90	F026H4FD006
91	F026H2GB012	89	F026H3CD012	91	F026H3GA012	89	F026H4CB012	90	F026H4FD012
91	F026H2GB018	89	F026H3CD018	91	F026H3GA018	89	F026H4CB018	90	F026H4FD018
91	F026H2GB030	89	F026H3CD030	91	F026H3GA030	89	F026H4CB030	90	F026H4FD030
91	F026H2GB033	89	F026H3CD033	91	F026H3GA033	89	F026H4CB033	90	F026H4FD033
91	F026H2GD001	90	F026H3DA001	91	F026H3GB001	89	F026H4CD001	91	F026H4GA001
91	F026H2GD006	90	F026H3DA006	91	F026H3GB006	89	F026H4CD006	91	F026H4GA006
91	F026H2GD012	90	F026H3DA012	91	F026H3GB012	89	F026H4CD012	91	F026H4GA012
91	F026H2GD018	90	F026H3DA018	91	F026H3GB018	89	F026H4CD018	91	F026H4GA018
91	F026H2GD030	90	F026H3DA030	91	F026H3GB030	89	F026H4CD030	91	F026H4GA030
91	F026H2GD033	90	F026H3DA033	91	F026H3GB033	89	F026H4CD033	91	F026H4GA033
91	F026H2HA001	90	F026H3DB001	91	F026H3GD001	90	F026H4DA001	91	F026H4GB001
91	F026H2HA006	90	F026H3DB006	91	F026H3GD006	90	F026H4DA006	91	F026H4GB006
91	F026H2HA012	90	F026H3DB012	91	F026H3GD012	90	F026H4DA012	91	F026H4GB012
91	F026H2HA018	90	F026H3DB018	91	F026H3GD018	90	F026H4DA018	91	F026H4GB018
91	F026H2HA030	90	F026H3DB030	91	F026H3GD030	90	F026H4DA030	91	F026H4GB030
91	F026H2HA033	90	F026H3DB033	91	F026H3GD033	90	F026H4DA033	91	F026H4GB033
91	F026H2HB001	90	F026H3DD001	91	F026H3HA001	90	F026H4DB001	91	F026H4GD001
91	F026H2HB006	90	F026H3DD006	91	F026H3HA006	90	F026H4DB006	91	F026H4GD006
91	F026H2HB012	90	F026H3DD012	91	F026H3HA012	90	F026H4DB012	91	F026H4GD012
91	F026H2HB018	90	F026H3DD018	91	F026H3HA018	90	F026H4DB018	91	F026H4GD018
91	F026H2HB030	90	F026H3DD030	91	F026H3HA030	90	F026H4DB030	91	F026H4GD030

Page	Reference	Page	Reference	Page	Reference	Page	Reference	Page	Reference
91	F026H4GD033	73	F026L2CA033	74	F026L2FB033	72	F026L3AD033	73	F026L3EA033
91	F026H4HA001	73	F026L2CB001	74	F026L2FD001	72	F026L3BA001	73	F026L3EB001
91	F026H4HA006	73	F026L2CB006	74	F026L2FD006	72	F026L3BA006	73	F026L3EB006
91	F026H4HA012	73	F026L2CB012	74	F026L2FD012	72	F026L3BA012	73	F026L3EB012
91	F026H4HA018	73	F026L2CB018	74	F026L2FD018	72	F026L3BA018	73	F026L3EB018
91	F026H4HA030	73	F026L2CB030	74	F026L2FD030	72	F026L3BA030	73	F026L3EB030
91	F026H4HA033	73	F026L2CB033	74	F026L2FD033	72	F026L3BA033	73	F026L3EB033
91	F026H4HB001	73	F026L2CD001	74	F026L2GA001	72	F026L3BB001	73	F026L3ED001
91	F026H4HB006	73	F026L2CD006	74	F026L2GA006	72	F026L3BB006	73	F026L3ED006
91	F026H4HB012	73	F026L2CD012	74	F026L2GA012	72	F026L3BB012	73	F026L3ED012
91	F026H4HB018	73	F026L2CD018	74	F026L2GA018	72	F026L3BB018	73	F026L3ED018
91	F026H4HB030	73	F026L2CD030	74	F026L2GA030	72	F026L3BB030	73	F026L3ED030
91	F026H4HB033	73	F026L2CD033	74	F026L2GA033	72	F026L3BB033	73	F026L3ED033
91	F026H4HD001	73	F026L2DA001	74	F026L2GB001	72	F026L3BD001	74	F026L3FA001
91	F026H4HD006	73	F026L2DA006	74	F026L2GB006	72	F026L3BD006	74	F026L3FA006
91	F026H4HD012	73	F026L2DA012	74	F026L2GB012	72	F026L3BD012	74	F026L3FA012
91	F026H4HD018	73	F026L2DA018	74	F026L2GB018	72	F026L3BD018	74	F026L3FA018
91	F026H4HD030	73	F026L2DA030	74	F026L2GB030	72	F026L3BD030	74	F026L3FA030
91	F026H4HD033	73	F026L2DA033	74	F026L2GB033	72	F026L3BD033	74	F026L3FA033
72	F026L2AA001	73	F026L2DB001	74	F026L2GD001	73	F026L3CA001	74	F026L3FB001
72	F026L2AA006	73	F026L2DB006	74	F026L2GD006	73	F026L3CA006	74	F026L3FB006
72	F026L2AA012	73	F026L2DB012	74	F026L2GD012	73	F026L3CA012	74	F026L3FB012
72	F026L2AA018	73	F026L2DB018	74	F026L2GD018	73	F026L3CA018	74	F026L3FB018
72	F026L2AA030	73	F026L2DB030	74	F026L2GD030	73	F026L3CA030	74	F026L3FB030
72	F026L2AA033	73	F026L2DB033	74	F026L2GD033	73	F026L3CA033	74	F026L3FB033
72	F026L2AB001	73	F026L2DD001	74	F026L2HA001	73	F026L3CB001	74	F026L3FD001
72	F026L2AB006	73	F026L2DD006	74	F026L2HA006	73	F026L3CB006	74	F026L3FD006
72	F026L2AB012	73	F026L2DD012	74	F026L2HA012	73	F026L3CB012	74	F026L3FD012
72	F026L2AB018	73	F026L2DD018	74	F026L2HA018	73	F026L3CB018	74	F026L3FD018
72	F026L2AB030	73	F026L2DD030	74	F026L2HA030	73	F026L3CB030	74	F026L3FD030
72	F026L2AB033	73	F026L2DD033	74	F026L2HA033	73	F026L3CB033	74	F026L3FD033
72	F026L2AD001	73	F026L2EA001	74	F026L2HB001	73	F026L3CD001	74	F026L3GA001
72	F026L2AD006	73	F026L2EA006	74	F026L2HB006	73	F026L3CD006	74	F026L3GA006
72	F026L2AD012	73	F026L2EA012	74	F026L2HB012	73	F026L3CD012	74	F026L3GA012
72	F026L2AD018	73	F026L2EA018	74	F026L2HB018	73	F026L3CD018	74	F026L3GA018
72	F026L2AD030	73	F026L2EA030	74	F026L2HB030	73	F026L3CD030	74	F026L3GA030
72	F026L2AD033	73	F026L2EA033	74	F026L2HB033	73	F026L3CD033	74	F026L3GA033
72	F026L2BA001	73	F026L2EB001	74	F026L2HD001	73	F026L3DA001	74	F026L3GB001
72	F026L2BA006	73	F026L2EB006	74	F026L2HD006	73	F026L3DA006	74	F026L3GB006
72	F026L2BA012	73	F026L2EB012	74	F026L2HD012	73	F026L3DA012	74	F026L3GB012
72	F026L2BA018	73	F026L2EB018	74	F026L2HD018	73	F026L3DA018	74	F026L3GB018
72	F026L2BA030	73	F026L2EB030	74	F026L2HD030	73	F026L3DA030	74	F026L3GB030
72	F026L2BA033	73	F026L2EB033	74	F026L2HD033	73	F026L3DA033	74	F026L3GB033
72	F026L2BB001	73	F026L2ED001	72	F026L3AA001	73	F026L3DB001	74	F026L3GD001
72	F026L2BB006	73	F026L2ED006	72	F026L3AA006	73	F026L3DB006	74	F026L3GD006
72	F026L2BB012	73	F026L2ED012	72	F026L3AA012	73	F026L3DB012	74	F026L3GD012
72	F026L2BB018	73	F026L2ED018	72	F026L3AA018	73	F026L3DB018	74	F026L3GD018
72	F026L2BB030	73	F026L2ED030	72	F026L3AA030	73	F026L3DB030	74	F026L3GD030
72	F026L2BB033	73	F026L2ED033	72	F026L3AA033	73	F026L3DB033	74	F026L3GD033
72	F026L2BD001	74	F026L2FA001	72	F026L3AB001	73	F026L3DD001	74	F026L3HA001
72	F026L2BD006	74	F026L2FA006	72	F026L3AB006	73	F026L3DD006	74	F026L3HA006
72	F026L2BD012	74	F026L2FA012	72	F026L3AB012	73	F026L3DD012	74	F026L3HA012
72	F026L2BD018	74	F026L2FA018	72	F026L3AB018	73	F026L3DD018	74	F026L3HA018
72	F026L2BD030	74	F026L2FA030	72	F026L3AB030	73	F026L3DD030	74	F026L3HA030
72	F026L2BD033	74	F026L2FA033	72	F026L3AB033	73	F026L3DD033	74	F026L3HA033
73	F026L2CA001	74	F026L2FB001	72	F026L3AD001	73	F026L3EA001	74	F026L3HB001
73	F026L2CA006	74	F026L2FB006	72	F026L3AD006	73	F026L3EA006	74	F026L3HB006
73	F026L2CA012	74	F026L2FB012	72	F026L3AD012	73	F026L3EA012	74	F026L3HB012
73	F026L2CA018	74	F026L2FB018	72	F026L3AD018	73	F026L3EA018	74	F026L3HB018
73	F026L2CA030	74	F026L2FB030	72	F026L3AD030	73	F026L3EA030	74	F026L3HB030

Page	Reference	Page	Reference	Page	Reference	Page	Reference	Page	Reference
74	F026L3HB033	73	F026L4CD033	74	F026L4GA033	75	F026M2CB033	76	F026M2FD033
74	F026L3HD001	73	F026L4DA001	74	F026L4GB001	75	F026M2CD001	77	F026M2GA001
74	F026L3HD006	73	F026L4DA006	74	F026L4GB006	75	F026M2CD006	77	F026M2GA006
74	F026L3HD012	73	F026L4DA012	74	F026L4GB012	75	F026M2CD012	77	F026M2GA012
74	F026L3HD018	73	F026L4DA018	74	F026L4GB018	75	F026M2CD018	77	F026M2GA018
74	F026L3HD030	73	F026L4DA030	74	F026L4GB030	75	F026M2CD030	77	F026M2GA030
74	F026L3HD033	73	F026L4DA033	74	F026L4GB033	75	F026M2CD033	77	F026M2GA033
72	F026L4AA001	73	F026L4DB001	74	F026L4GD001	76	F026M2DA001	77	F026M2GB001
72	F026L4AA006	73	F026L4DB006	74	F026L4GD006	76	F026M2DA006	77	F026M2GB006
72	F026L4AA012	73	F026L4DB012	74	F026L4GD012	76	F026M2DA012	77	F026M2GB012
72	F026L4AA018	73	F026L4DB018	74	F026L4GD018	76	F026M2DA018	77	F026M2GB018
72	F026L4AA030	73	F026L4DB030	74	F026L4GD030	76	F026M2DA030	77	F026M2GB030
72	F026L4AA033	73	F026L4DB033	74	F026L4GD033	76	F026M2DA033	77	F026M2GB033
72	F026L4AB001	73	F026L4DD001	74	F026L4HA001	76	F026M2DB001	77	F026M2GD001
72	F026L4AB006	73	F026L4DD006	74	F026L4HA006	76	F026M2DB006	77	F026M2GD006
72	F026L4AB012	73	F026L4DD012	74	F026L4HA012	76	F026M2DB012	77	F026M2GD012
72	F026L4AB018	73	F026L4DD018	74	F026L4HA018	76	F026M2DB018	77	F026M2GD018
72	F026L4AB030	73	F026L4DD030	74	F026L4HA030	76	F026M2DB030	77	F026M2GD030
72	F026L4AB033	73	F026L4DD033	74	F026L4HA033	76	F026M2DB033	77	F026M2GD033
72	F026L4AD001	73	F026L4EA001	74	F026L4HB001	76	F026M2DD001	77	F026M2HA001
72	F026L4AD006	73	F026L4EA006	74	F026L4HB006	76	F026M2DD006	77	F026M2HA006
72	F026L4AD012	73	F026L4EA012	74	F026L4HB012	76	F026M2DD012	77	F026M2HA012
72	F026L4AD018	73	F026L4EA018	74	F026L4HB018	76	F026M2DD018	77	F026M2HA018
72	F026L4AD030	73	F026L4EA030	74	F026L4HB030	76	F026M2DD030	77	F026M2HA030
72	F026L4AD033	73	F026L4EA033	74	F026L4HB033	76	F026M2DD033	77	F026M2HA033
72	F026L4BA001	73	F026L4EB001	74	F026L4HD001	76	F026M2EA001	77	F026M2HB001
72	F026L4BA006	73	F026L4EB006	74	F026L4HD006	76	F026M2EA006	77	F026M2HB006
72	F026L4BA012	73	F026L4EB012	74	F026L4HD012	76	F026M2EA012	77	F026M2HB012
72	F026L4BA018	73	F026L4EB018	74	F026L4HD018	76	F026M2EA018	77	F026M2HB018
72	F026L4BA030	73	F026L4EB030	74	F026L4HD030	76	F026M2EA030	77	F026M2HB030
72	F026L4BA033	73	F026L4EB033	74	F026L4HD033	76	F026M2EA033	77	F026M2HB033
72	F026L4BB001	73	F026L4ED001	75	F026M2BA001	76	F026M2EB001	77	F026M2HD001
72	F026L4BB006	73	F026L4ED006	75	F026M2BA006	76	F026M2EB006	77	F026M2HD006
72	F026L4BB012	73	F026L4ED012	75	F026M2BA012	76	F026M2EB012	77	F026M2HD012
72	F026L4BB018	73	F026L4ED018	75	F026M2BA018	76	F026M2EB018	77	F026M2HD018
72	F026L4BB030	73	F026L4ED030	75	F026M2BA030	76	F026M2EB030	77	F026M2HD030
72	F026L4BB033	73	F026L4ED033	75	F026M2BA033	76	F026M2EB033	77	F026M2HD033
72	F026L4BD001	74	F026L4FA001	75	F026M2BB001	76	F026M2ED001	75	F026M3BA001
72	F026L4BD006	74	F026L4FA006	75	F026M2BB006	76	F026M2ED006	75	F026M3BA006
72	F026L4BD012	74	F026L4FA012	75	F026M2BB012	76	F026M2ED012	75	F026M3BA012
72	F026L4BD018	74	F026L4FA018	75	F026M2BB018	76	F026M2ED018	75	F026M3BA018
72	F026L4BD030	74	F026L4FA030	75	F026M2BB030	76	F026M2ED030	75	F026M3BA030
72	F026L4BD033	74	F026L4FA033	75	F026M2BB033	76	F026M2ED033	75	F026M3BA033
73	F026L4CA001	74	F026L4FB001	75	F026M2BD001	76	F026M2FA001	75	F026M3BB001
73	F026L4CA006	74	F026L4FB006	75	F026M2BD006	76	F026M2FA006	75	F026M3BB006
73	F026L4CA012	74	F026L4FB012	75	F026M2BD012	76	F026M2FA012	75	F026M3BB012
73	F026L4CA018	74	F026L4FB018	75	F026M2BD018	76	F026M2FA018	75	F026M3BB018
73	F026L4CA030	74	F026L4FB030	75	F026M2BD030	76	F026M2FA030	75	F026M3BB030
73	F026L4CA033	74	F026L4FB033	75	F026M2BD033	76	F026M2FA033	75	F026M3BB033
73	F026L4CB001	74	F026L4FD001	75	F026M2CA001	76	F026M2FB001	75	F026M3BD001
73	F026L4CB006	74	F026L4FD006	75	F026M2CA006	76	F026M2FB006	75	F026M3BD006
73	F026L4CB012	74	F026L4FD012	75	F026M2CA012	76	F026M2FB012	75	F026M3BD012
73	F026L4CB018	74	F026L4FD018	75	F026M2CA018	76	F026M2FB018	75	F026M3BD018
73	F026L4CB030	74	F026L4FD030	75	F026M2CA030	76	F026M2FB030	75	F026M3BD030
73	F026L4CB033	74	F026L4FD033	75	F026M2CA033	76	F026M2FB033	75	F026M3BD033
73	F026L4CD001	74	F026L4GA001	75	F026M2CB001	76	F026M2FD001	75	F026M3CA001
73	F026L4CD006	74	F026L4GA006	75	F026M2CB006	76	F026M2FD006	75	F026M3CA006
73	F026L4CD012	74	F026L4GA012	75	F026M2CB012	76	F026M2FD012	75	F026M3CA012
73	F026L4CD018	74	F026L4GA018	75	F026M2CB018	76	F026M2FD018	75	F026M3CA018
73	F026L4CD030	74	F026L4GA030	75	F026M2CB030	76	F026M2FD030	75	F026M3CA030

Page	Reference	Page	Reference	Page	Reference	Page	Reference	Page	Reference
75	F026M3CA033	76	F026M3FB033	75	F026M4BD033	76	F026M4FA033	97	F026Q2BB033.A
75	F026M3CB001	76	F026M3FD001	75	F026M4CA001	76	F026M4FB001	97	F026Q2BD001.A
75	F026M3CB006	76	F026M3FD006	75	F026M4CA006	76	F026M4FB006	97	F026Q2BD006.A
75	F026M3CB012	76	F026M3FD012	75	F026M4CA012	76	F026M4FB012	97	F026Q2BD012.A
75	F026M3CB018	76	F026M3FD018	75	F026M4CA018	76	F026M4FB018	97	F026Q2BD018.A
75	F026M3CB030	76	F026M3FD030	75	F026M4CA030	76	F026M4FB030	97	F026Q2BD030.A
75	F026M3CB033	76	F026M3FD033	75	F026M4CA033	76	F026M4FB033	97	F026Q2BD033.A
75	F026M3CD001	77	F026M3GA001	75	F026M4CB001	76	F026M4FD001	97	F026Q2CA001.A
75	F026M3CD006	77	F026M3GA006	75	F026M4CB006	76	F026M4FD006	97	F026Q2CA006.A
75	F026M3CD012	77	F026M3GA012	75	F026M4CB012	76	F026M4FD012	97	F026Q2CA012.A
75	F026M3CD018	77	F026M3GA018	75	F026M4CB018	76	F026M4FD018	97	F026Q2CA018.A
75	F026M3CD030	77	F026M3GA030	75	F026M4CB030	76	F026M4FD030	97	F026Q2CA030.A
75	F026M3CD033	77	F026M3GA033	75	F026M4CB033	76	F026M4FD033	97	F026Q2CA033.A
76	F026M3DA001	77	F026M3GB001	75	F026M4CD001	77	F026M4GA001	97	F026Q2CB001.A
76	F026M3DA006	77	F026M3GB006	75	F026M4CD006	77	F026M4GA006	97	F026Q2CB006.A
76	F026M3DA012	77	F026M3GB012	75	F026M4CD012	77	F026M4GA012	97	F026Q2CB012.A
76	F026M3DA018	77	F026M3GB018	75	F026M4CD018	77	F026M4GA018	97	F026Q2CB018.A
76	F026M3DA030	77	F026M3GB030	75	F026M4CD030	77	F026M4GA030	97	F026Q2CB030.A
76	F026M3DA033	77	F026M3GB033	75	F026M4CD033	77	F026M4GA033	97	F026Q2CB033.A
76	F026M3DB001	77	F026M3GD001	76	F026M4DA001	77	F026M4GB001	97	F026Q2CD001.A
76	F026M3DB006	77	F026M3GD006	76	F026M4DA006	77	F026M4GB006	97	F026Q2CD006.A
76	F026M3DB012	77	F026M3GD012	76	F026M4DA012	77	F026M4GB012	97	F026Q2CD012.A
76	F026M3DB018	77	F026M3GD018	76	F026M4DA018	77	F026M4GB018	97	F026Q2CD018.A
76	F026M3DB030	77	F026M3GD030	76	F026M4DA030	77	F026M4GB030	97	F026Q2CD030.A
76	F026M3DB033	77	F026M3GD033	76	F026M4DA033	77	F026M4GB033	97	F026Q2CD033.A
76	F026M3DD001	77	F026M3HA001	76	F026M4DB001	77	F026M4GD001	97	F026Q3BA001
76	F026M3DD006	77	F026M3HA006	76	F026M4DB006	77	F026M4GD006	97	F026Q3BA006
76	F026M3DD012	77	F026M3HA012	76	F026M4DB012	77	F026M4GD012	97	F026Q3BA012
76	F026M3DD018	77	F026M3HA018	76	F026M4DB018	77	F026M4GD018	97	F026Q3BA018
76	F026M3DD030	77	F026M3HA030	76	F026M4DB030	77	F026M4GD030	97	F026Q3BA030
76	F026M3DD033	77	F026M3HA033	76	F026M4DB033	77	F026M4GD033	97	F026Q3BA033
76	F026M3EA001	77	F026M3HB001	76	F026M4DD001	77	F026M4HA001	97	F026Q3BB001
76	F026M3EA006	77	F026M3HB006	76	F026M4DD006	77	F026M4HA006	97	F026Q3BB006
76	F026M3EA012	77	F026M3HB012	76	F026M4DD012	77	F026M4HA012	97	F026Q3BB012
76	F026M3EA018	77	F026M3HB018	76	F026M4DD018	77	F026M4HA018	97	F026Q3BB018
76	F026M3EA030	77	F026M3HB030	76	F026M4DD030	77	F026M4HA030	97	F026Q3BB030
76	F026M3EA033	77	F026M3HB033	76	F026M4DD033	77	F026M4HA033	97	F026Q3BB033
76	F026M3EB001	77	F026M3HD001	76	F026M4EA001	77	F026M4HB001	97	F026Q3BD001
76	F026M3EB006	77	F026M3HD006	76	F026M4EA006	77	F026M4HB006	97	F026Q3BD006
76	F026M3EB012	77	F026M3HD012	76	F026M4EA012	77	F026M4HB012	97	F026Q3BD012
76	F026M3EB018	77	F026M3HD018	76	F026M4EA018	77	F026M4HB018	97	F026Q3BD018
76	F026M3EB030	77	F026M3HD030	76	F026M4EA030	77	F026M4HB030	97	F026Q3BD030
76	F026M3EB033	77	F026M3HD033	76	F026M4EA033	77	F026M4HB033	97	F026Q3BD033
76	F026M3ED001	75	F026M4BA001	76	F026M4EB001	77	F026M4HD001	97	F026Q3CA001
76	F026M3ED006	75	F026M4BA006	76	F026M4EB006	77	F026M4HD006	97	F026Q3CA006
76	F026M3ED012	75	F026M4BA012	76	F026M4EB012	77	F026M4HD012	97	F026Q3CA012
76	F026M3ED018	75	F026M4BA018	76	F026M4EB018	77	F026M4HD018	97	F026Q3CA018
76	F026M3ED030	75	F026M4BA030	76	F026M4EB030	77	F026M4HD030	97	F026Q3CA030
76	F026M3ED033	75	F026M4BA033	76	F026M4EB033	77	F026M4HD033	97	F026Q3CA033
76	F026M3FA001	75	F026M4BB001	76	F026M4ED001	97	F026Q2BA001.A	97	F026Q3CB001
76	F026M3FA006	75	F026M4BB006	76	F026M4ED006	97	F026Q2BA006.A	97	F026Q3CB006
76	F026M3FA012	75	F026M4BB012	76	F026M4ED012	97	F026Q2BA012.A	97	F026Q3CB012
76	F026M3FA018	75	F026M4BB018	76	F026M4ED018	97	F026Q2BA018.A	97	F026Q3CB018
76	F026M3FA030	75	F026M4BB030	76	F026M4ED030	97	F026Q2BA030.A	97	F026Q3CB030
76	F026M3FA033	75	F026M4BB033	76	F026M4ED033	97	F026Q2BA033.A	97	F026Q3CB033
76	F026M3FB001	75	F026M4BD001	76	F026M4FA001	97	F026Q2BB001.A	97	F026Q3CD001
76	F026M3FB006	75	F026M4BD006	76	F026M4FA006	97	F026Q2BB006.A	97	F026Q3CD006
76	F026M3FB012	75	F026M4BD012	76	F026M4FA012	97	F026Q2BB012.A	97	F026Q3CD012
76	F026M3FB018	75	F026M4BD018	76	F026M4FA018	97	F026Q2BB018.A	97	F026Q3CD018
76	F026M3FB030	75	F026M4BD030	76	F026M4FA030	97	F026Q2BB030.A	97	F026Q3CD030

Page	Reference	Page	Reference	Page	Reference	Page	Reference	Page	Reference
107	F026W3GA033	105	F026W4CB033	106	F026W4FD033	155	F026Z210006	126	F02713CA018
107	F026W3GB001	105	F026W4CD001	107	F026W4GA001	155	F026Z210018	126	F02713CA030
107	F026W3GB006	105	F026W4CD006	107	F026W4GA006	155	F026Z210033	126	F02713CA033
107	F026W3GB012	105	F026W4CD012	107	F026W4GA012	155	F026Z220006	126	F02713DA001
107	F026W3GB018	105	F026W4CD018	107	F026W4GA018	155	F026Z220018	126	F02713DA006
107	F026W3GB030	105	F026W4CD030	107	F026W4GA030	155	F026Z220033	126	F02713DA012
107	F026W3GB033	105	F026W4CD033	107	F026W4GA033	155	F026Z230006	126	F02713DA018
107	F026W3GD001	106	F026W4DA001	107	F026W4GB001	155	F026Z230018	126	F02713DA030
107	F026W3GD006	106	F026W4DA006	107	F026W4GB006	155	F026Z230033	126	F02713DA033
107	F026W3GD012	106	F026W4DA012	107	F026W4GB012	126	F02712BA001	126	F02713EA001
107	F026W3GD018	106	F026W4DA018	107	F026W4GB018	126	F02712BA006	126	F02713EA006
107	F026W3GD030	106	F026W4DA030	107	F026W4GB030	126	F02712BA012	126	F02713EA012
107	F026W3GD033	106	F026W4DA033	107	F026W4GB033	126	F02712BA018	126	F02713EA018
107	F026W3HA001	106	F026W4DB001	107	F026W4GD001	126	F02712BA030	126	F02713EA030
107	F026W3HA006	106	F026W4DB006	107	F026W4GD006	126	F02712BA033	126	F02713EA033
107	F026W3HA012	106	F026W4DB012	107	F026W4GD012	126	F02712CA001	127	F02713FA001
107	F026W3HA018	106	F026W4DB018	107	F026W4GD018	126	F02712CA006	127	F02713FA006
107	F026W3HA030	106	F026W4DB030	107	F026W4GD030	126	F02712CA012	127	F02713FA012
107	F026W3HA033	106	F026W4DB033	107	F026W4GD033	126	F02712CA018	127	F02713FA018
107	F026W3HB001	106	F026W4DD001	107	F026W4HA001	126	F02712CA030	127	F02713FA030
107	F026W3HB006	106	F026W4DD006	107	F026W4HA006	126	F02712CA033	127	F02713FA033
107	F026W3HB012	106	F026W4DD012	107	F026W4HA012	126	F02712DA001	127	F02713GA001
107	F026W3HB018	106	F026W4DD018	107	F026W4HA018	126	F02712DA006	127	F02713GA006
107	F026W3HB030	106	F026W4DD030	107	F026W4HA030	126	F02712DA012	127	F02713GA012
107	F026W3HB033	106	F026W4DD033	107	F026W4HA033	126	F02712DA018	127	F02713GA018
107	F026W3HD001	106	F026W4EA001	107	F026W4HB001	126	F02712DA030	127	F02713GA030
107	F026W3HD006	106	F026W4EA006	107	F026W4HB006	126	F02712DA033	127	F02713GA033
107	F026W3HD012	106	F026W4EA012	107	F026W4HB012	126	F02712EA001	127	F02713HA001
107	F026W3HD018	106	F026W4EA018	107	F026W4HB018	126	F02712EA006	127	F02713HA006
107	F026W3HD030	106	F026W4EA030	107	F026W4HB030	126	F02712EA012	127	F02713HA012
107	F026W3HD033	106	F026W4EA033	107	F026W4HB033	126	F02712EA018	127	F02713HA018
105	F026W4BA001	106	F026W4EB001	107	F026W4HD001	126	F02712EA030	127	F02713HA030
105	F026W4BA006	106	F026W4EB006	107	F026W4HD006	126	F02712EA033	127	F02713HA033
105	F026W4BA012	106	F026W4EB012	107	F026W4HD012	127	F02712FA001	126	F02714BA001
105	F026W4BA018	106	F026W4EB018	107	F026W4HD018	127	F02712FA006	126	F02714BA006
105	F026W4BA030	106	F026W4EB030	107	F026W4HD030	127	F02712FA012	126	F02714BA012
105	F026W4BA033	106	F026W4EB033	107	F026W4HD033	127	F02712FA018	126	F02714BA018
105	F026W4BB001	106	F026W4ED001	51	F026Z010000	127	F02712FA030	126	F02714BA030
105	F026W4BB006	106	F026W4ED006	64	F026Z020001	127	F02712FA033	126	F02714BA033
105	F026W4BB012	106	F026W4ED012	64	F026Z020006	127	F02712GA001	126	F02714CA001
105	F026W4BB018	106	F026W4ED018	64	F026Z020012	127	F02712GA006	126	F02714CA006
105	F026W4BB030	106	F026W4ED030	64	F026Z020018	127	F02712GA012	126	F02714CA012
105	F026W4BB033	106	F026W4ED033	64	F026Z020030	127	F02712GA018	126	F02714CA018
105	F026W4BD001	106	F026W4FA001	64	F026Z020033	127	F02712GA030	126	F02714CA030
105	F026W4BD006	106	F026W4FA006	64	F026Z030001	127	F02712GA033	126	F02714CA033
105	F026W4BD012	106	F026W4FA012	64	F026Z030006	127	F02712HA001	126	F02714DA001
105	F026W4BD018	106	F026W4FA018	64	F026Z030012	127	F02712HA006	126	F02714DA006
105	F026W4BD030	106	F026W4FA030	64	F026Z030018	127	F02712HA012	126	F02714DA012
105	F026W4BD033	106	F026W4FA033	64	F026Z030030	127	F02712HA018	126	F02714DA018
105	F026W4CA001	106	F026W4FB001	64	F026Z030033	127	F02712HA030	126	F02714DA030
105	F026W4CA006	106	F026W4FB006	57	F026Z050001	127	F02712HA033	126	F02714DA033
105	F026W4CA012	106	F026W4FB012	57	F026Z050006	126	F02713BA001	126	F02714EA001
105	F026W4CA018	106	F026W4FB018	57	F026Z050012	126	F02713BA006	126	F02714EA006
105	F026W4CA030	106	F026W4FB030	57	F026Z050018	126	F02713BA012	126	F02714EA012
105	F026W4CA033	106	F026W4FB033	57	F026Z050030	126	F02713BA018	126	F02714EA018
105	F026W4CB001	106	F026W4FD001	57	F026Z050033	126	F02713BA030	126	F02714EA030
105	F026W4CB006	106	F026W4FD006	37	F026Z060000	126	F02713BA033	126	F02714EA033
105	F026W4CB012	106	F026W4FD012	155	F026Z200006	126	F02713CA001	127	F02714FA001
105	F026W4CB018	106	F026W4FD018	155	F026Z200018	126	F02713CA006	127	F02714FA006
105	F026W4CB030	106	F026W4FD030	155	F026Z200033	126	F02713CA012	127	F02714FA012

Page	Reference	Page	Reference	Page	Reference	Page	Reference	Page	Reference
127	F02714FA018	124	F02753BA018	124	F02754EA018	33	F027B2HA018	32	F027B4DA018
127	F02714FA030	124	F02753BA030	124	F02754EA030	33	F027B2HA030	32	F027B4DA030
127	F02714FA033	124	F02753BA033	124	F02754EA033	33	F027B2HA033	32	F027B4DA033
127	F02714GA001	124	F02753CA001	125	F02754FA001	32	F027B3BA001	32	F027B4EA001
127	F02714GA006	124	F02753CA006	125	F02754FA006	32	F027B3BA006	32	F027B4EA006
127	F02714GA012	124	F02753CA012	125	F02754FA012	32	F027B3BA012	32	F027B4EA012
127	F02714GA018	124	F02753CA018	125	F02754FA018	32	F027B3BA018	32	F027B4EA018
127	F02714GA030	124	F02753CA030	125	F02754FA030	32	F027B3BA030	32	F027B4EA030
127	F02714GA033	124	F02753CA033	125	F02754FA033	32	F027B3BA033	32	F027B4EA033
127	F02714HA001	124	F02753DA001	125	F02754GA001	32	F027B3CA001	33	F027B4FA001
127	F02714HA006	124	F02753DA006	125	F02754GA006	32	F027B3CA006	33	F027B4FA006
127	F02714HA012	124	F02753DA012	125	F02754GA012	32	F027B3CA012	33	F027B4FA012
127	F02714HA018	124	F02753DA018	125	F02754GA018	32	F027B3CA018	33	F027B4FA018
127	F02714HA030	124	F02753DA030	125	F02754GA030	32	F027B3CA030	33	F027B4FA030
127	F02714HA033	124	F02753DA033	125	F02754GA033	32	F027B3CA033	33	F027B4FA033
124	F02752BA001	124	F02753EA001	125	F02754HA001	32	F027B3DA001	33	F027B4GA001
124	F02752BA006	124	F02753EA006	125	F02754HA006	32	F027B3DA006	33	F027B4GA006
124	F02752BA012	124	F02753EA012	125	F02754HA012	32	F027B3DA012	33	F027B4GA012
124	F02752BA018	124	F02753EA018	125	F02754HA018	32	F027B3DA018	33	F027B4GA018
124	F02752BA030	124	F02753EA030	125	F02754HA030	32	F027B3DA030	33	F027B4GA030
124	F02752BA033	124	F02753EA033	125	F02754HA033	32	F027B3DA033	33	F027B4GA033
124	F02752CA001	125	F02753FA001	32	F027B2BA001	32	F027B3EA001	33	F027B4HA001
124	F02752CA006	125	F02753FA006	32	F027B2BA006	32	F027B3EA006	33	F027B4HA006
124	F02752CA012	125	F02753FA012	32	F027B2BA012	32	F027B3EA012	33	F027B4HA012
124	F02752CA018	125	F02753FA018	32	F027B2BA018	32	F027B3EA018	33	F027B4HA018
124	F02752CA030	125	F02753FA030	32	F027B2BA030	32	F027B3EA030	33	F027B4HA030
124	F02752CA033	125	F02753FA033	32	F027B2BA033	32	F027B3EA033	33	F027B4HA033
124	F02752DA001	125	F02753GA001	32	F027B2CA001	33	F027B3FA001	30	F027D2BA001
124	F02752DA006	125	F02753GA006	32	F027B2CA006	33	F027B3FA006	30	F027D2BA006
124	F02752DA012	125	F02753GA012	32	F027B2CA012	33	F027B3FA012	30	F027D2BA012
124	F02752DA018	125	F02753GA018	32	F027B2CA018	33	F027B3FA018	30	F027D2BA018
124	F02752DA030	125	F02753GA030	32	F027B2CA030	33	F027B3FA030	30	F027D2BA030
124	F02752DA033	125	F02753GA033	32	F027B2CA033	33	F027B3FA033	30	F027D2BA033
124	F02752EA001	125	F02753HA001	32	F027B2DA001	33	F027B3GA001	30	F027D2CA001
124	F02752EA006	125	F02753HA006	32	F027B2DA006	33	F027B3GA006	30	F027D2CA006
124	F02752EA012	125	F02753HA012	32	F027B2DA012	33	F027B3GA012	30	F027D2CA012
124	F02752EA018	125	F02753HA018	32	F027B2DA018	33	F027B3GA018	30	F027D2CA018
124	F02752EA030	125	F02753HA030	32	F027B2DA030	33	F027B3GA030	30	F027D2CA030
124	F02752EA033	125	F02753HA033	32	F027B2DA033	33	F027B3GA033	30	F027D2CA033
125	F02752FA001	124	F02754BA001	32	F027B2EA001	33	F027B3HA001	30	F027D2DA001
125	F02752FA006	124	F02754BA006	32	F027B2EA006	33	F027B3HA006	30	F027D2DA006
125	F02752FA012	124	F02754BA012	32	F027B2EA012	33	F027B3HA012	30	F027D2DA012
125	F02752FA018	124	F02754BA018	32	F027B2EA018	33	F027B3HA018	30	F027D2DA018
125	F02752FA030	124	F02754BA030	32	F027B2EA030	33	F027B3HA030	30	F027D2DA030
125	F02752FA033	124	F02754BA033	32	F027B2EA033	33	F027B3HA033	30	F027D2DA033
125	F02752GA001	124	F02754CA001	33	F027B2FA001	32	F027B4BA001	30	F027D2EA001
125	F02752GA006	124	F02754CA006	33	F027B2FA006	32	F027B4BA006	30	F027D2EA006
125	F02752GA012	124	F02754CA012	33	F027B2FA012	32	F027B4BA012	30	F027D2EA012
125	F02752GA018	124	F02754CA018	33	F027B2FA018	32	F027B4BA018	30	F027D2EA018
125	F02752GA030	124	F02754CA030	33	F027B2FA030	32	F027B4BA030	30	F027D2EA030
125	F02752GA033	124	F02754CA033	33	F027B2FA033	32	F027B4BA033	30	F027D2EA033
125	F02752HA001	124	F02754DA001	33	F027B2GA001	32	F027B4CA001	31	F027D2FA001
125	F02752HA006	124	F02754DA006	33	F027B2GA006	32	F027B4CA006	31	F027D2FA006
125	F02752HA012	124	F02754DA012	33	F027B2GA012	32	F027B4CA012	31	F027D2FA012
125	F02752HA018	124	F02754DA018	33	F027B2GA018	32	F027B4CA018	31	F027D2FA018
125	F02752HA030	124	F02754DA030	33	F027B2GA030	32	F027B4CA030	31	F027D2FA030
125	F02752HA033	124	F02754DA033	33	F027B2GA033	32	F027B4CA033	31	F027D2FA033
124	F02753BA001	124	F02754EA001	33	F027B2HA001	32	F027B4DA001	31	F027D2GA001
124	F02753BA006	124	F02754EA006	33	F027B2HA006	32	F027B4DA006	31	F027D2GA006
124	F02753BA012	124	F02754EA012	33	F027B2HA012	32	F027B4DA012	31	F027D2GA012

Page	Reference	Page	Reference	Page	Reference	Page	Reference	Page	Reference
31	F027D2GA018	30	F027D4CA018	63	F027G2FA018	62	F027G4BA018	60	F027L2EA018
31	F027D2GA030	30	F027D4CA030	63	F027G2FA030	62	F027G4BA030	60	F027L2EA030
31	F027D2GA033	30	F027D4CA033	63	F027G2FA033	62	F027G4BA033	60	F027L2EA033
31	F027D2HA001	30	F027D4DA001	63	F027G2GA001	62	F027G4CA001	61	F027L2FA001
31	F027D2HA006	30	F027D4DA006	63	F027G2GA006	62	F027G4CA006	61	F027L2FA006
31	F027D2HA012	30	F027D4DA012	63	F027G2GA012	62	F027G4CA012	61	F027L2FA012
31	F027D2HA018	30	F027D4DA018	63	F027G2GA018	62	F027G4CA018	61	F027L2FA018
31	F027D2HA030	30	F027D4DA030	63	F027G2GA030	62	F027G4CA030	61	F027L2FA030
31	F027D2HA033	30	F027D4DA033	63	F027G2GA033	62	F027G4CA033	61	F027L2FA033
30	F027D3BA001	30	F027D4EA001	63	F027G2HA001	62	F027G4DA001	61	F027L2GA001
30	F027D3BA006	30	F027D4EA006	63	F027G2HA006	62	F027G4DA006	61	F027L2GA006
30	F027D3BA012	30	F027D4EA012	63	F027G2HA012	62	F027G4DA012	61	F027L2GA012
30	F027D3BA018	30	F027D4EA018	63	F027G2HA018	62	F027G4DA018	61	F027L2GA018
30	F027D3BA030	30	F027D4EA030	63	F027G2HA030	62	F027G4DA030	61	F027L2GA030
30	F027D3BA033	30	F027D4EA033	63	F027G2HA033	62	F027G4DA033	61	F027L2GA033
30	F027D3CA001	31	F027D4FA001	62	F027G3BA001	62	F027G4EA001	61	F027L2HA001
30	F027D3CA006	31	F027D4FA006	62	F027G3BA006	62	F027G4EA006	61	F027L2HA006
30	F027D3CA012	31	F027D4FA012	62	F027G3BA012	62	F027G4EA012	61	F027L2HA012
30	F027D3CA018	31	F027D4FA018	62	F027G3BA018	62	F027G4EA018	61	F027L2HA018
30	F027D3CA030	31	F027D4FA030	62	F027G3BA030	62	F027G4EA030	61	F027L2HA030
30	F027D3CA033	31	F027D4FA033	62	F027G3BA033	62	F027G4EA033	61	F027L2HA033
30	F027D3DA001	31	F027D4GA001	62	F027G3CA001	63	F027G4FA001	60	F027L3BA001
30	F027D3DA006	31	F027D4GA006	62	F027G3CA006	63	F027G4FA006	60	F027L3BA006
30	F027D3DA012	31	F027D4GA012	62	F027G3CA012	63	F027G4FA012	60	F027L3BA012
30	F027D3DA018	31	F027D4GA018	62	F027G3CA018	63	F027G4FA018	60	F027L3BA018
30	F027D3DA030	31	F027D4GA030	62	F027G3CA030	63	F027G4FA030	60	F027L3BA030
30	F027D3DA033	31	F027D4GA033	62	F027G3CA033	63	F027G4FA033	60	F027L3BA033
30	F027D3EA001	31	F027D4HA001	62	F027G3DA001	63	F027G4GA001	60	F027L3CA001
30	F027D3EA006	31	F027D4HA006	62	F027G3DA006	63	F027G4GA006	60	F027L3CA006
30	F027D3EA012	31	F027D4HA012	62	F027G3DA012	63	F027G4GA012	60	F027L3CA012
30	F027D3EA018	31	F027D4HA018	62	F027G3DA018	63	F027G4GA018	60	F027L3CA018
30	F027D3EA030	31	F027D4HA030	62	F027G3DA030	63	F027G4GA030	60	F027L3CA030
30	F027D3EA033	31	F027D4HA033	62	F027G3DA033	63	F027G4GA033	60	F027L3CA033
31	F027D3FA001	62	F027G2BA001	62	F027G3EA001	63	F027G4HA001	60	F027L3DA001
31	F027D3FA006	62	F027G2BA006	62	F027G3EA006	63	F027G4HA006	60	F027L3DA006
31	F027D3FA012	62	F027G2BA012	62	F027G3EA012	63	F027G4HA012	60	F027L3DA012
31	F027D3FA018	62	F027G2BA018	62	F027G3EA018	63	F027G4HA018	60	F027L3DA018
31	F027D3FA030	62	F027G2BA030	62	F027G3EA030	63	F027G4HA030	60	F027L3DA030
31	F027D3FA033	62	F027G2BA033	62	F027G3EA033	63	F027G4HA033	60	F027L3DA033
31	F027D3GA001	62	F027G2CA001	63	F027G3FA001	60	F027L2BA001	60	F027L3EA001
31	F027D3GA006	62	F027G2CA006	63	F027G3FA006	60	F027L2BA006	60	F027L3EA006
31	F027D3GA012	62	F027G2CA012	63	F027G3FA012	60	F027L2BA012	60	F027L3EA012
31	F027D3GA018	62	F027G2CA018	63	F027G3FA018	60	F027L2BA018	60	F027L3EA018
31	F027D3GA030	62	F027G2CA030	63	F027G3FA030	60	F027L2BA030	60	F027L3EA030
31	F027D3GA033	62	F027G2CA033	63	F027G3FA033	60	F027L2BA033	60	F027L3EA033
31	F027D3HA001	62	F027G2DA001	63	F027G3GA001	60	F027L2CA001	61	F027L3FA001
31	F027D3HA006	62	F027G2DA006	63	F027G3GA006	60	F027L2CA006	61	F027L3FA006
31	F027D3HA012	62	F027G2DA012	63	F027G3GA012	60	F027L2CA012	61	F027L3FA012
31	F027D3HA018	62	F027G2DA018	63	F027G3GA018	60	F027L2CA018	61	F027L3FA018
31	F027D3HA030	62	F027G2DA030	63	F027G3GA030	60	F027L2CA030	61	F027L3FA030
31	F027D3HA033	62	F027G2DA033	63	F027G3GA033	60	F027L2CA033	61	F027L3FA033
30	F027D4BA001	62	F027G2EA001	63	F027G3HA001	60	F027L2DA001	61	F027L3GA001
30	F027D4BA006	62	F027G2EA006	63	F027G3HA006	60	F027L2DA006	61	F027L3GA006
30	F027D4BA012	62	F027G2EA012	63	F027G3HA012	60	F027L2DA012	61	F027L3GA012
30	F027D4BA018	62	F027G2EA018	63	F027G3HA018	60	F027L2DA018	61	F027L3GA018
30	F027D4BA030	62	F027G2EA030	63	F027G3HA030	60	F027L2DA030	61	F027L3GA030
30	F027D4BA033	62	F027G2EA033	63	F027G3HA033	60	F027L2DA033	61	F027L3GA033
30	F027D4CA001	63	F027G2FA001	62	F027G4BA001	60	F027L2EA001	61	F027L3HA001
30	F027D4CA006	63	F027G2FA006	62	F027G4BA006	60	F027L2EA006	61	F027L3HA006
30	F027D4CA012	63	F027G2FA012	62	F027G4BA012	60	F027L2EA012	61	F027L3HA012

Page	Reference	Page	Reference	Page	Reference	Page	Reference	Page	Reference
61	F027L3HA018	47	F029Z020000	233	F030A23B030	233	F030A33B006	233	F030A43A033
61	F027L3HA030	47	F029Z021000	233	F030A23B033	233	F030A33B012	233	F030A43B000
61	F027L3HA033	47	F029Z022000	233	F030A23D000	233	F030A33B018	233	F030A43B001
60	F027L4BA001	47	F029Z023000	233	F030A23D001	233	F030A33B030	233	F030A43B006
60	F027L4BA006	47	F029Z024000	233	F030A23D006	233	F030A33B033	233	F030A43B012
60	F027L4BA012	47	F029Z025000	233	F030A23D012	233	F030A33D000	233	F030A43B018
60	F027L4BA018	232	F030A21A000	233	F030A23D018	233	F030A33D001	233	F030A43B030
60	F027L4BA030	232	F030A21A001	233	F030A23D030	233	F030A33D006	233	F030A43B033
60	F027L4BA033	232	F030A21A006	233	F030A23D033	233	F030A33D012	233	F030A43D000
60	F027L4CA001	232	F030A21A012	232	F030A31A000	233	F030A33D018	233	F030A43D001
60	F027L4CA006	232	F030A21A018	232	F030A31A001	233	F030A33D030	233	F030A43D006
60	F027L4CA012	232	F030A21A030	232	F030A31A006	233	F030A33D033	233	F030A43D012
60	F027L4CA018	232	F030A21A033	232	F030A31A012	232	F030A41A000	233	F030A43D018
60	F027L4CA030	232	F030A21B000	232	F030A31A018	232	F030A41A001	233	F030A43D030
60	F027L4CA033	232	F030A21B001	232	F030A31A030	232	F030A41A006	233	F030A43D033
60	F027L4DA001	232	F030A21B006	232	F030A31A033	232	F030A41A012	236	F030B21A000
60	F027L4DA006	232	F030A21B012	232	F030A31B000	232	F030A41A018	236	F030B21A001
60	F027L4DA012	232	F030A21B018	232	F030A31B001	232	F030A41A030	236	F030B21A006
60	F027L4DA018	232	F030A21B030	232	F030A31B006	232	F030A41A033	236	F030B21A012
60	F027L4DA030	232	F030A21B033	232	F030A31B012	232	F030A41B000	236	F030B21A018
60	F027L4DA033	232	F030A21D000	232	F030A31B018	232	F030A41B001	236	F030B21A030
60	F027L4EA001	232	F030A21D001	232	F030A31B030	232	F030A41B006	236	F030B21A033
60	F027L4EA006	232	F030A21D006	232	F030A31B033	232	F030A41B012	236	F030B21B000
60	F027L4EA012	232	F030A21D012	232	F030A31D000	232	F030A41B018	236	F030B21B001
60	F027L4EA018	232	F030A21D018	232	F030A31D001	232	F030A41B030	236	F030B21B006
60	F027L4EA030	232	F030A21D030	232	F030A31D006	232	F030A41B033	236	F030B21B012
60	F027L4EA033	232	F030A21D033	232	F030A31D012	232	F030A41D000	236	F030B21B018
61	F027L4FA001	232	F030A22A000	232	F030A31D018	232	F030A41D001	236	F030B21B030
61	F027L4FA006	232	F030A22A001	232	F030A31D030	232	F030A41D006	236	F030B21B033
61	F027L4FA012	232	F030A22A006	232	F030A31D033	232	F030A41D012	236	F030B21D000
61	F027L4FA018	232	F030A22A012	232	F030A32A000	232	F030A41D018	236	F030B21D001
61	F027L4FA030	232	F030A22A018	232	F030A32A001	232	F030A41D030	236	F030B21D006
61	F027L4FA033	232	F030A22A030	232	F030A32A006	232	F030A41D033	236	F030B21D012
61	F027L4GA001	232	F030A22A033	232	F030A32A012	232	F030A42A000	236	F030B21D018
61	F027L4GA006	232	F030A22B000	232	F030A32A018	232	F030A42A001	236	F030B21D030
61	F027L4GA012	232	F030A22B001	232	F030A32A030	232	F030A42A006	236	F030B21D033
61	F027L4GA018	232	F030A22B006	232	F030A32A033	232	F030A42A012	236	F030B22A000
61	F027L4GA030	232	F030A22B012	232	F030A32B000	232	F030A42A018	236	F030B22A001
61	F027L4GA033	232	F030A22B018	232	F030A32B001	232	F030A42A030	236	F030B22A006
61	F027L4HA001	232	F030A22B030	232	F030A32B006	232	F030A42A033	236	F030B22A012
61	F027L4HA006	232	F030A22B033	232	F030A32B012	232	F030A42B000	236	F030B22A018
61	F027L4HA012	232	F030A22D000	232	F030A32B018	232	F030A42B001	236	F030B22A030
61	F027L4HA018	232	F030A22D001	232	F030A32B030	232	F030A42B006	236	F030B22A033
61	F027L4HA030	232	F030A22D006	232	F030A32B033	232	F030A42B012	236	F030B22B000
61	F027L4HA033	232	F030A22D012	232	F030A32D000	232	F030A42B018	236	F030B22B001
35	F027Z010000	232	F030A22D018	232	F030A32D001	232	F030A42B030	236	F030B22B006
34	F027Z010000	232	F030A22D030	232	F030A32D006	232	F030A42B033	236	F030B22B012
35	F027Z050001	232	F030A22D033	232	F030A32D012	232	F030A42D000	236	F030B22B018
35	F027Z050006	233	F030A23A000	232	F030A32D018	232	F030A42D001	236	F030B22B030
35	F027Z050012	233	F030A23A001	232	F030A32D030	232	F030A42D006	236	F030B22B033
35	F027Z050018	233	F030A23A006	232	F030A32D033	232	F030A42D012	236	F030B22D000
35	F027Z050030	233	F030A23A012	233	F030A33A000	232	F030A42D018	236	F030B22D001
35	F027Z050033	233	F030A23A018	233	F030A33A001	232	F030A42D030	236	F030B22D006
34	F027Z060000	233	F030A23A030	233	F030A33A006	232	F030A42D033	236	F030B22D012
34	F029Z010000	233	F030A23A033	233	F030A33A012	233	F030A43A000	236	F030B22D018
34	F029Z011000	233	F030A23B000	233	F030A33A018	233	F030A43A001	236	F030B22D030
34	F029Z012000	233	F030A23B001	233	F030A33A030	233	F030A43A006	236	F030B22D033
34	F029Z013000	233	F030A23B006	233	F030A33A033	233	F030A43A012	237	F030B23A000
34	F029Z014000	233	F030A23B012	233	F030A33B000	233	F030A43A018	237	F030B23A001
34	F029Z015000	233	F030A23B018	233	F030A33B001	233	F030A43A030	237	F030B23A006

Page	Reference	Page	Reference	Page	Reference	Page	Reference	Page	Reference
234	F030C42B006	238	F030D22A033	238	F030D32A012	238	F030D42A000	432	F1110030-310.A
234	F030C42B012	238	F030D22B000	238	F030D32A018	238	F030D42A001	432	F1110030.A
234	F030C42B018	238	F030D22B001	238	F030D32A030	238	F030D42A006	432	F1110033-300.A
234	F030C42B030	238	F030D22B006	238	F030D32A033	238	F030D42A012	432	F1110033-310.A
234	F030C42B033	238	F030D22B012	238	F030D32B000	238	F030D42A018	432	F1110033.A
234	F030C42D000	238	F030D22B018	238	F030D32B001	238	F030D42A030	432	F1111001-300.A
234	F030C42D001	238	F030D22B030	238	F030D32B006	238	F030D42A033	432	F1111001-310.A
234	F030C42D006	238	F030D22B033	238	F030D32B012	238	F030D42B000	432	F1111001.A
234	F030C42D012	238	F030D22D000	238	F030D32B018	238	F030D42B001	432	F1111006-300.A
234	F030C42D018	238	F030D22D001	238	F030D32B030	238	F030D42B006	432	F1111006-310.A
234	F030C42D030	238	F030D22D006	238	F030D32B033	238	F030D42B012	432	F1111006.A
234	F030C42D033	238	F030D22D012	238	F030D32D000	238	F030D42B018	432	F1111012-300.A
235	F030C43A000	238	F030D22D018	238	F030D32D001	238	F030D42B030	432	F1111012-310.A
235	F030C43A001	238	F030D22D030	238	F030D32D006	238	F030D42B033	432	F1111012.A
235	F030C43A006	238	F030D22D033	238	F030D32D012	238	F030D42D000	432	F1111018-300.A
235	F030C43A012	239	F030D23A000	238	F030D32D018	238	F030D42D001	432	F1111018-310.A
235	F030C43A018	239	F030D23A001	238	F030D32D030	238	F030D42D006	432	F1111018.A
235	F030C43A030	239	F030D23A006	238	F030D32D033	238	F030D42D012	432	F1111030-300.A
235	F030C43A033	239	F030D23A012	239	F030D33A000	238	F030D42D018	432	F1111030-310.A
235	F030C43B000	239	F030D23A018	239	F030D33A001	238	F030D42D030	432	F1111030.A
235	F030C43B001	239	F030D23A030	239	F030D33A006	238	F030D42D033	432	F1111033-300.A
235	F030C43B006	239	F030D23A033	239	F030D33A012	239	F030D43A000	432	F1111033-310.A
235	F030C43B012	239	F030D23B000	239	F030D33A018	239	F030D43A001	432	F1111033.A
235	F030C43B018	239	F030D23B001	239	F030D33A030	239	F030D43A006	432	F1112001-300.A
235	F030C43B030	239	F030D23B006	239	F030D33A033	239	F030D43A012	432	F1112001-310.A
235	F030C43B033	239	F030D23B012	239	F030D33B000	239	F030D43A018	432	F1112001.A
235	F030C43D000	239	F030D23B018	239	F030D33B001	239	F030D43A030	432	F1112006-300.A
235	F030C43D001	239	F030D23B030	239	F030D33B006	239	F030D43A033	432	F1112006-310.A
235	F030C43D006	239	F030D23B033	239	F030D33B012	239	F030D43B000	432	F1112006.A
235	F030C43D012	239	F030D23D000	239	F030D33B018	239	F030D43B001	432	F1112012-300.A
235	F030C43D018	239	F030D23D001	239	F030D33B030	239	F030D43B006	432	F1112012-310.A
235	F030C43D030	239	F030D23D006	239	F030D33B033	239	F030D43B012	432	F1112012.A
235	F030C43D033	239	F030D23D012	239	F030D33D000	239	F030D43B018	432	F1112018-300.A
238	F030D21A000	239	F030D23D018	239	F030D33D001	239	F030D43B030	432	F1112018-310.A
238	F030D21A001	239	F030D23D030	239	F030D33D006	239	F030D43B033	432	F1112018.A
238	F030D21A006	239	F030D23D033	239	F030D33D012	239	F030D43D000	432	F1112030-300.A
238	F030D21A012	238	F030D31A000	239	F030D33D018	239	F030D43D001	432	F1112030-310.A
238	F030D21A018	238	F030D31A001	239	F030D33D030	239	F030D43D006	432	F1112030.A
238	F030D21A030	238	F030D31A006	239	F030D33D033	239	F030D43D012	432	F1112033-300.A
238	F030D21A033	238	F030D31A012	238	F030D41A000	239	F030D43D018	432	F1112033-310.A
238	F030D21B000	238	F030D31A018	238	F030D41A001	239	F030D43D030	432	F1112033.A
238	F030D21B001	238	F030D31A030	238	F030D41A006	239	F030D43D033	432	F1113001-300.A
238	F030D21B006	238	F030D31A033	238	F030D41A012	237	F030Z010000	432	F1113001-310.A
238	F030D21B012	238	F030D31B000	238	F030D41A018	239	F030Z020000	432	F1113001.A
238	F030D21B018	238	F030D31B001	238	F030D41A030	204	F038AAAAOZZ	432	F1113006-300.A
238	F030D21B030	238	F030D31B006	238	F030D41A033	204	F038AABA0ZZ	432	F1113006-310.A
238	F030D21B033	238	F030D31B012	238	F030D41B000	204	F038AACA0ZZ	432	F1113006.A
238	F030D21D000	238	F030D31B018	238	F030D41B001	432	F1110001-300.A	432	F1113012-300.A
238	F030D21D001	238	F030D31B030	238	F030D41B006	432	F1110001-310.A	432	F1113012-310.A
238	F030D21D006	238	F030D31B033	238	F030D41B012	432	F1110001.A	432	F1113012.A
238	F030D21D012	238	F030D31D000	238	F030D41B018	432	F1110006-300.A	432	F1113018-300.A
238	F030D21D018	238	F030D31D001	238	F030D41B030	432	F1110006-310.A	432	F1113018-310.A
238	F030D21D030	238	F030D31D006	238	F030D41B033	432	F1110006.A	432	F1113018.A
238	F030D21D033	238	F030D31D012	238	F030D41D000	432	F1110012-300.A	432	F1113030-300.A
238	F030D22A000	238	F030D31D018	238	F030D41D001	432	F1110012-310.A	432	F1113030-310.A
238	F030D22A001	238	F030D31D030	238	F030D41D006	432	F1110012.A	432	F1113030.A
238	F030D22A006	238	F030D31D033	238	F030D41D012	432	F1110018-300.A	432	F1113033-300.A
238	F030D22A012	238	F030D32A000	238	F030D41D018	432	F1110018-310.A	432	F1113033-310.A
238	F030D22A018	238	F030D32A001	238	F030D41D030	432	F1110018.A	432	F1113033.A
238	F030D22A030	238	F030D32A006	238	F030D41D033	432	F1110030-300.A	432	F1114001-300.A

Page	Reference	Page	Reference	Page	Reference	Page	Reference	Page	Reference
432	F1114001-310.A	433	F1117012-310.A	433	F1120030-310.A	436	F1142001-300.B	436	F1145012-300.A
432	F1114001.A	433	F1117012.A	433	F1120030.A	436	F1142001-310.A	436	F1145012-310
432	F1114006-300.A	433	F1117018-300.A	433	F1120033-300.A	436	F1142006	436	F1145018
432	F1114006-310.A	433	F1117018-310.A	433	F1120033-310.A	436	F1142006-300.B	436	F1145018-300.A
432	F1114006.A	433	F1117018.A	433	F1120033.A	436	F1142006-310.A	436	F1145018-310
432	F1114012-300.A	433	F1117030-300.A	433	F1121001-300.A	436	F1142012	436	F1145030
432	F1114012-310.A	433	F1117030-310.A	433	F1121001-310.A	436	F1142012-300.B	436	F1145030-300.A
432	F1114012.A	433	F1117030.A	433	F1121001.A	436	F1142012-310.A	436	F1145030-310
432	F1114018-300.A	433	F1117033-300.A	433	F1121006-300.A	436	F1142018	436	F1145033
432	F1114018-310.A	433	F1117033-310.A	433	F1121006-310.A	436	F1142018-300.B	436	F1145033-300.A
432	F1114018.A	433	F1117033.A	433	F1121006.A	436	F1142018-310.A	436	F1145033-310
432	F1114030-300.A	433	F1118001-300.A	433	F1121012-300.A	436	F1142030	437	F1146001
432	F1114030-310.A	433	F1118001-310.A	433	F1121012-310.A	436	F1142030-300.B	437	F1146001-300.B
432	F1114030.A	433	F1118001.A	433	F1121012.A	436	F1142030-310.A	437	F1146001-310.A
432	F1114033-300.A	433	F1118006-300.A	433	F1121018-300.A	436	F1142033	437	F1146006
432	F1114033-310.A	433	F1118006-310.A	433	F1121018-310.A	436	F1142033-300.B	437	F1146006-300.B
432	F1114033.A	433	F1118006.A	433	F1121018.A	436	F1142033-310.A	437	F1146006-310.A
432	F1115001-300.A	433	F1118012-300.A	433	F1121030-300.A	436	F1143001	437	F1146012
432	F1115001-310.A	433	F1118012-310.A	433	F1121030-310.A	436	F1143001-300.B	437	F1146012-300.B
432	F1115001.A	433	F1118012.A	433	F1121030.A	436	F1143001-310.A	437	F1146012-310.A
432	F1115006-300.A	433	F1118018-300.A	433	F1121033-300.A	436	F1143006	437	F1146018
432	F1115006-310.A	433	F1118018-310.A	433	F1121033-310.A	436	F1143006-300.B	437	F1146018-300.B
432	F1115006.A	433	F1118018.A	433	F1121033.A	436	F1143006-310.A	437	F1146018-310.A
432	F1115012-300.A	433	F1118030-300.A	436	F1140001	436	F1143012	437	F1146030
432	F1115012-310.A	433	F1118030-310.A	436	F1140001-300.B	436	F1143012-300.B	437	F1146030-300.B
432	F1115012.A	433	F1118030.A	436	F1140001-310.A	436	F1143012-310.A	437	F1146030-310.A
432	F1115018-300.A	433	F1118033-300.A	436	F1140006	436	F1143018	437	F1146033
432	F1115018-310.A	433	F1118033-310.A	436	F1140006-300.B	436	F1143018-300.B	437	F1146033-300.B
432	F1115018.A	433	F1118033.A	436	F1140006-310.A	436	F1143018-310.A	437	F1146033-310.A
432	F1115030-300.A	433	F1119001-300.A	436	F1140012	436	F1143030	437	F1147001
432	F1115030-310.A	433	F1119001-310.A	436	F1140012-300.B	436	F1143030-300.B	437	F1147001-300.B
432	F1115030.A	433	F1119001.A	436	F1140012-310.A	436	F1143030-310.A	437	F1147001-310.A
432	F1115033-300.A	433	F1119006-300.A	436	F1140018	436	F1143033	437	F1147006
432	F1115033-310.A	433	F1119006-310.A	436	F1140018-300.B	436	F1143033-300.B	437	F1147006-300.B
432	F1115033.A	433	F1119006.A	436	F1140018-310.A	436	F1143033-310.A	437	F1147006-310.A
433	F1116001-300.A	433	F1119012-300.A	436	F1140030	436	F1144001	437	F1147012
433	F1116001-310.A	433	F1119012-310.A	436	F1140030-300.B	436	F1144001-300.B	437	F1147012-300.B
433	F1116001.A	433	F1119012.A	436	F1140030-310.A	436	F1144001-310.A	437	F1147012-310.A
433	F1116006-300.A	433	F1119018-300.A	436	F1140033	436	F1144006	437	F1147018
433	F1116006-310.A	433	F1119018-310.A	436	F1140033-300.B	436	F1144006-300.B	437	F1147018-300.B
433	F1116006.A	433	F1119018.A	436	F1140033-310.A	436	F1144006-310.A	437	F1147018-310.A
433	F1116012-300.A	433	F1119030-300.A	436	F1141001	436	F1144012	437	F1147030
433	F1116012-310.A	433	F1119030-310.A	436	F1141001-300.B	436	F1144012-300.B	437	F1147030-300.B
433	F1116012.A	433	F1119030.A	436	F1141001-310.A	436	F1144012-310.A	437	F1147030-310.A
433	F1116018-300.A	433	F1119033-300.A	436	F1141006	436	F1144018	437	F1147033
433	F1116018-310.A	433	F1119033-310.A	436	F1141006-300.B	436	F1144018-300.B	437	F1147033-300.B
433	F1116018.A	433	F1119033.A	436	F1141006-310.A	436	F1144018-310.A	437	F1147033-310.A
433	F1116030-300.A	433	F1120001-300.A	436	F1141012	436	F1144030	437	F1148001
433	F1116030-310.A	433	F1120001-310.A	436	F1141012-300.B	436	F1144030-300.B	437	F1148001-300.B
433	F1116030.A	433	F1120001.A	436	F1141012-310.A	436	F1144030-310.A	437	F1148001-310.A
433	F1116033-300.A	433	F1120006-300.A	436	F1141018	436	F1144033	437	F1148006
433	F1116033-310.A	433	F1120006-310.A	436	F1141018-300.B	436	F1144033-300.B	437	F1148006-300.B
433	F1116033.A	433	F1120006.A	436	F1141018-310.A	436	F1144033-310.A	437	F1148006-310.A
433	F1117001-300.A	433	F1120012-300.A	436	F1141030	436	F1145001	437	F1148012
433	F1117001-310.A	433	F1120012-310.A	436	F1141030-300.B	436	F1145001-300.A	437	F1148012-300.B
433	F1117001.A	433	F1120012.A	436	F1141030-310.A	436	F1145001-310	437	F1148012-310.A
433	F1117006-300.A	433	F1120018-300.A	436	F1141033	436	F1145006	437	F1148018
433	F1117006-310.A	433	F1120018-310.A	436	F1141033-300.B	436	F1145006-300.A	437	F1148018-300.B
433	F1117006.A	433	F1120018.A	436	F1141033-310.A	436	F1145006-310	437	F1148018-310.A
433	F1117012-300.A	433	F1120030-300.A	436	F1142001	436	F1145012	437	F1148030

Page	Reference	Page	Reference	Page	Reference	Page	Reference	Page	Reference
437	F1148030-300.B	438	F1170001-300.A	438	F1173012-300.A	439	F1176030-300.A	439	F1180001-300.A
437	F1148030-310.A	438	F1170001-310.A	438	F1173012-310.A	439	F1176030-310.A	439	F1180001-310.A
437	F1148033	438	F1170006	438	F1173018	439	F1176033	439	F1180006
437	F1148033-300.B	438	F1170006-300.A	438	F1173018-300.A	439	F1176033-300.A	439	F1180006-300.A
437	F1148033-310.A	438	F1170006-310.A	438	F1173018-310.A	439	F1176033-310.A	439	F1180006-310.A
437	F1149001	438	F1170012	438	F1173030	439	F1177001	439	F1180012
437	F1149001-300.B	438	F1170012-300.A	438	F1173030-300.A	439	F1177001-300.A	439	F1180012-300.A
437	F1149001-310.A	438	F1170012-310.A	438	F1173030-310.A	439	F1177001-310.A	439	F1180012-310.A
437	F1149006	438	F1170018	438	F1173033	439	F1177006	439	F1180018
437	F1149006-300.B	438	F1170018-300.A	438	F1173033-300.A	439	F1177006-300.A	439	F1180018-300.A
437	F1149006-310.A	438	F1170018-310.A	438	F1173033-310.A	439	F1177006-310.A	439	F1180018-310.A
437	F1149012	438	F1170030	438	F1174001	439	F1177012	439	F1180030
437	F1149012-300.B	438	F1170030-300.A	438	F1174001-300.A	439	F1177012-300.A	439	F1180030-300.A
437	F1149012-310.A	438	F1170030-310.A	438	F1174001-310.A	439	F1177012-310.A	439	F1180030-310.A
437	F1149018	438	F1170033	438	F1174006	439	F1177018	439	F1180033
437	F1149018-300.B	438	F1170033-300.A	438	F1174006-300.A	439	F1177018-300.A	439	F1180033-300.A
437	F1149018-310.A	438	F1170033-310.A	438	F1174006-310.A	439	F1177018-310.A	439	F1180033-310.A
437	F1149030	438	F1171001	438	F1174012	439	F1177030	439	F1181001
437	F1149030-300.B	438	F1171001-300.A	438	F1174012-300.A	439	F1177030-300.A	439	F1181001-300.A
437	F1149030-310.A	438	F1171001-310.A	438	F1174012-310.A	439	F1177030-310.A	439	F1181001-310.A
437	F1149033	438	F1171006	438	F1174018	439	F1177033	439	F1181006
437	F1149033-300.B	438	F1171006-300.A	438	F1174018-300.A	439	F1177033-300.A	439	F1181006-300.A
437	F1149033-310.A	438	F1171006-310.A	438	F1174018-310.A	439	F1177033-310.A	439	F1181006-310.A
437	F1150001	438	F1171012	438	F1174030	439	F1178001	439	F1181012
437	F1150001-300.B	438	F1171012-300.A	438	F1174030-300.A	439	F1178001-300.A	439	F1181012-300.A
437	F1150001-310.A	438	F1171012-310.A	438	F1174030-310.A	439	F1178001-310.A	439	F1181012-310.A
437	F1150006	438	F1171018	438	F1174033	439	F1178006	439	F1181018
437	F1150006-300.B	438	F1171018-300.A	438	F1174033-300.A	439	F1178006-300.A	439	F1181018-300.A
437	F1150006-310.A	438	F1171018-310.A	438	F1174033-310.A	439	F1178006-310.A	439	F1181018-310.A
437	F1150012	438	F1171030	438	F1175001	439	F1178012	439	F1181030
437	F1150012-300.B	438	F1171030-300.A	438	F1175001-300.A	439	F1178012-300.A	439	F1181030-300.A
437	F1150012-310.A	438	F1171030-310.A	438	F1175001-310.A	439	F1178012-310.A	439	F1181030-310.A
437	F1150018	438	F1171033	438	F1175006	439	F1178018	439	F1181033
437	F1150018-300.B	438	F1171033-300.A	438	F1175006-300.A	439	F1178018-300.A	439	F1181033-300.A
437	F1150018-310.A	438	F1171033-310.A	438	F1175006-310.A	439	F1178018-310.A	439	F1181033-310.A
437	F1150030	438	F1172001	438	F1175012	439	F1178030	624	F1203001
437	F1150030-300.B	438	F1172001-300.A	438	F1175012-300.A	439	F1178030-300.A	624	F1203006
437	F1150030-310.A	438	F1172001-310.A	438	F1175012-310.A	439	F1178030-310.A	624	F1203012
437	F1150033	438	F1172006	438	F1175018	439	F1178033	624	F1203018
437	F1150033-300.B	438	F1172006-300.A	438	F1175018-300.A	439	F1178033-300.A	624	F1203030
437	F1150033-310.A	438	F1172006-310.A	438	F1175018-310.A	439	F1178033-310.A	624	F1203033
437	F1151001	438	F1172012	438	F1175030	439	F1179001	624	F1204001
437	F1151001-300.B	438	F1172012-300.A	438	F1175030-300.A	439	F1179001-300.A	624	F1204006
437	F1151001-310.A	438	F1172012-310.A	438	F1175030-310.A	439	F1179001-310.A	624	F1204012
437	F1151006	438	F1172018	438	F1175033	439	F1179006	624	F1204018
437	F1151006-300.B	438	F1172018-300.A	438	F1175033-300.A	439	F1179006-300.A	624	F1204030
437	F1151006-310.A	438	F1172018-310.A	438	F1175033-310.A	439	F1179006-310.A	624	F1204033
437	F1151012	438	F1172030	439	F1176001	439	F1179012	333	F1207000
437	F1151012-300.B	438	F1172030-300.A	439	F1176001-300.A	439	F1179012-300.A	333	F1208000
437	F1151012-310.A	438	F1172030-310.A	439	F1176001-310.A	439	F1179012-310.A	328	F1209000
437	F1151018	438	F1172033	439	F1176006	439	F1179018	329	F1210001
437	F1151018-300.B	438	F1172033-300.A	439	F1176006-300.A	439	F1179018-300.A	329	F1210006
437	F1151018-310.A	438	F1172033-310.A	439	F1176006-310.A	439	F1179018-310.A	329	F1210012
437	F1151030	438	F1173001	439	F1176012	439	F1179030	329	F1210018
437	F1151030-300.B	438	F1173001-300.A	439	F1176012-300.A	439	F1179030-300.A	329	F1210030
437	F1151030-310.A	438	F1173001-310.A	439	F1176012-310.A	439	F1179030-310.A	329	F1210033
437	F1151033	438	F1173006	439	F1176018	439	F1179033	329	F1211001
437	F1151033-300.B	438	F1173006-300.A	439	F1176018-300.A	439	F1179033-300.A	329	F1211006
437	F1151033-310.A	438	F1173006-310.A	439	F1176018-310.A	439	F1179033-310.A	329	F1211012
438	F1170001	438	F1173012	439	F1176030	439	F1180001	329	F1211018

Page	Reference	Page	Reference	Page	Reference	Page	Reference	Page	Reference
329	F1211030	330	F1230033-300	330	F1234006-300	330	F1237018-300	331	F1255030
329	F1211033	330	F1230033-310	330	F1234006-310	330	F1237018-310	331	F1255033
329	F1212001	330	F1231001	330	F1234012	330	F1237030	331	F1256001
329	F1212006	330	F1231001-300	330	F1234012-300	330	F1237030-300	331	F1256006
329	F1212012	330	F1231001-310	330	F1234012-310	330	F1237030-310	331	F1256012
329	F1212018	330	F1231006	330	F1234018	330	F1237033	331	F1256018
329	F1212030	330	F1231006-300	330	F1234018-300	330	F1237033-300	331	F1256030
329	F1212033	330	F1231006-310	330	F1234018-310	330	F1237033-310	331	F1256033
329	F1213001	330	F1231012	330	F1234030	330	F1238001	331	F1257001
329	F1213006	330	F1231012-300	330	F1234030-300	330	F1238001-300	331	F1257006
329	F1213012	330	F1231012-310	330	F1234030-310	330	F1238001-310	331	F1257012
329	F1213018	330	F1231018	330	F1234033	330	F1238006	331	F1257018
329	F1213030	330	F1231018-300	330	F1234033-300	330	F1238006-300	331	F1257030
329	F1213033	330	F1231018-310	330	F1234033-310	330	F1238006-310	331	F1257033
329	F1214001	330	F1231030	330	F1235001	330	F1238012	331	F1258001
329	F1214006	330	F1231030-300	330	F1235001-300	330	F1238012-300	331	F1258006
329	F1214012	330	F1231030-310	330	F1235001-310	330	F1238012-310	331	F1258012
329	F1214018	330	F1231033	330	F1235006	330	F1238018	331	F1258018
329	F1214030	330	F1231033-300	330	F1235006-300	330	F1238018-300	331	F1258030
329	F1214033	330	F1231033-310	330	F1235006-310	330	F1238018-310	331	F1258033
329	F1215001	330	F1232001	330	F1235012	330	F1238030	332	F1270001
329	F1215006	330	F1232001-300	330	F1235012-300	330	F1238030-300	332	F1270001-300
329	F1215012	330	F1232001-310	330	F1235012-310	330	F1238030-310	332	F1270001-310
329	F1215018	330	F1232006	330	F1235018	330	F1238033	332	F1270006
329	F1215030	330	F1232006-300	330	F1235018-300	330	F1238033-300	332	F1270006-300
329	F1215033	330	F1232006-310	330	F1235018-310	330	F1238033-310	332	F1270006-310
329	F1216001	330	F1232012	330	F1235030	331	F1250001	332	F1270012
329	F1216006	330	F1232012-300	330	F1235030-300	331	F1250006	332	F1270012-300
329	F1216012	330	F1232012-310	330	F1235030-310	331	F1250012	332	F1270012-310
329	F1216018	330	F1232018	330	F1235033	331	F1250018	332	F1270018
329	F1216030	330	F1232018-300	330	F1235033-300	331	F1250030	332	F1270018-300
329	F1216033	330	F1232018-310	330	F1235033-310	331	F1250033	332	F1270018-310
329	F1217001	330	F1232030	330	F1236001	331	F1251001	332	F1270030
329	F1217006	330	F1232030-300	330	F1236001-300	331	F1251006	332	F1270030-300
329	F1217012	330	F1232030-310	330	F1236001-310	331	F1251012	332	F1270030-310
329	F1217018	330	F1232033	330	F1236006	331	F1251018	332	F1270033
329	F1217030	330	F1232033-300	330	F1236006-300	331	F1251030	332	F1270033-300
329	F1217033	330	F1232033-310	330	F1236006-310	331	F1251033	332	F1270033-310
329	F1218001	330	F1233001	330	F1236012	331	F1252001	332	F1271001
329	F1218006	330	F1233001-300	330	F1236012-300	331	F1252006	332	F1271001-300
329	F1218012	330	F1233001-310	330	F1236012-310	331	F1252012	332	F1271001-310
329	F1218018	330	F1233006	330	F1236018	331	F1252018	332	F1271006
329	F1218030	330	F1233006-300	330	F1236018-300	331	F1252030	332	F1271006-300
329	F1218033	330	F1233006-310	330	F1236018-310	331	F1252033	332	F1271006-310
330	F1230001	330	F1233012	330	F1236030	331	F1253001	332	F1271012
330	F1230001-300	330	F1233012-300	330	F1236030-300	331	F1253006	332	F1271012-300
330	F1230001-310	330	F1233012-310	330	F1236030-310	331	F1253012	332	F1271012-310
330	F1230006	330	F1233018	330	F1236033	331	F1253018	332	F1271018
330	F1230006-300	330	F1233018-300	330	F1236033-300	331	F1253030	332	F1271018-300
330	F1230006-310	330	F1233018-310	330	F1236033-310	331	F1253033	332	F1271018-310
330	F1230012	330	F1233030	330	F1237001	331	F1254001	332	F1271030
330	F1230012-300	330	F1233030-300	330	F1237001-300	331	F1254006	332	F1271030-300
330	F1230012-310	330	F1233030-310	330	F1237001-310	331	F1254012	332	F1271030-310
330	F1230018	330	F1233033	330	F1237006	331	F1254018	332	F1271033
330	F1230018-300	330	F1233033-300	330	F1237006-300	331	F1254030	332	F1271033-300
330	F1230018-310	330	F1233033-310	330	F1237006-310	331	F1254033	332	F1271033-310
330	F1230030	330	F1234001	330	F1237012	331	F1255001	332	F1272001
330	F1230030-300	330	F1234001-300	330	F1237012-300	331	F1255006	332	F1272001-300
330	F1230030-310	330	F1234001-310	330	F1237012-310	331	F1255012	332	F1272001-310
330	F1230033	330	F1234006	330	F1237018	331	F1255018	332	F1272006

Page	Reference	Page	Reference	Page	Reference	Page	Reference	Page	Reference
332	F1272006-300	332	F1275018-300	332	F1278033-300	422	F1315090-300	422	F1317090-300
332	F1272006-310	332	F1275018-310	332	F1278033-310	422	F1315090-310	422	F1317090-310
332	F1272012	332	F1275030	422	F1310000	422	F1316000	423	F1318000
332	F1272012-300	332	F1275030-300	422	F1310001	422	F1316000-300	328	F1330089.A
332	F1272012-310	332	F1275030-310	422	F1310006	422	F1316000-310	328	F1331089.A
332	F1272018	332	F1275033	422	F1310012	422	F1316001	328	F1332089.A
332	F1272018-300	332	F1275033-300	422	F1310018	422	F1316001-300	468	F2250001
332	F1272018-310	332	F1275033-310	422	F1310030	422	F1316001-310	468	F2250006
332	F1272030	332	F1276001	422	F1310033	422	F1316006	468	F2250012
332	F1272030-300	332	F1276001-300	422	F1310087	422	F1316006-300	468	F2250018
332	F1272030-310	332	F1276001-310	422	F1310089	422	F1316006-310	468	F2250030
332	F1272033	332	F1276006	422	F1310090	422	F1316012	468	F2250033
332	F1272033-300	332	F1276006-300	422	F1311000	422	F1316012-300	468	F2251001
332	F1272033-310	332	F1276006-310	422	F1311001	422	F1316012-310	468	F2251006
332	F1273001	332	F1276012	422	F1311006	422	F1316018	468	F2251012
332	F1273001-300	332	F1276012-300	422	F1311012	422	F1316018-300	468	F2251018
332	F1273001-310	332	F1276012-310	422	F1311018	422	F1316018-310	468	F2251030
332	F1273006	332	F1276018	422	F1311030	422	F1316030	468	F2251033
332	F1273006-300	332	F1276018-300	422	F1311033	422	F1316030-300	468	F2252001
332	F1273006-310	332	F1276018-310	422	F1311087	422	F1316030-310	468	F2252006
332	F1273012	332	F1276030	422	F1311089	422	F1316033	468	F2252012
332	F1273012-300	332	F1276030-300	422	F1311090	422	F1316033-300	468	F2252018
332	F1273012-310	332	F1276030-310	422	F1312000	422	F1316033-310	468	F2252030
332	F1273018	332	F1276033	422	F1312001	422	F1316087	468	F2252033
332	F1273018-300	332	F1276033-300	422	F1312006	422	F1316087-300	468	F2260001
332	F1273018-310	332	F1276033-310	422	F1312012	422	F1316087-310	468	F2260006
332	F1273030	332	F1277001	422	F1312018	422	F1316089	468	F2260012
332	F1273030-300	332	F1277001-300	422	F1312030	422	F1316089-300	468	F2260018
332	F1273030-310	332	F1277001-310	422	F1312033	422	F1316089-310	468	F2260030
332	F1273033	332	F1277006	422	F1312087	422	F1316090	468	F2260033
332	F1273033-300	332	F1277006-300	422	F1312089	422	F1316090-300	468	F2261001
332	F1273033-310	332	F1277006-310	422	F1312090	422	F1316090-310	468	F2261006
332	F1274001	332	F1277012	422	F1315000	422	F1317000	468	F2261012
332	F1274001-300	332	F1277012-300	422	F1315000-300	422	F1317000-300	468	F2261018
332	F1274001-310	332	F1277012-310	422	F1315000-310	422	F1317000-310	468	F2261030
332	F1274006	332	F1277018	422	F1315001	422	F1317001	468	F2261033
332	F1274006-300	332	F1277018-300	422	F1315001-300	422	F1317001-300	468	F2262001
332	F1274006-310	332	F1277018-310	422	F1315001-310	422	F1317001-310	468	F2262006
332	F1274012	332	F1277030	422	F1315006	422	F1317006	468	F2262012
332	F1274012-300	332	F1277030-300	422	F1315006-300	422	F1317006-300	468	F2262018
332	F1274012-310	332	F1277030-310	422	F1315006-310	422	F1317006-310	468	F2262030
332	F1274018	332	F1277033	422	F1315012	422	F1317012	468	F2262033
332	F1274018-300	332	F1277033-300	422	F1315012-300	422	F1317012-300	415	F4301000
332	F1274018-310	332	F1277033-310	422	F1315012-310	422	F1317012-310	415	F4302000
332	F1274030	332	F1278001	422	F1315018	422	F1317018	415	F4303000
332	F1274030-300	332	F1278001-300	422	F1315018-300	422	F1317018-300	414	F4350001
332	F1274030-310	332	F1278001-310	422	F1315018-310	422	F1317018-310	414	F4350006
332	F1274033	332	F1278006	422	F1315030	422	F1317030	414	F4350012
332	F1274033-300	332	F1278006-300	422	F1315030-300	422	F1317030-300	414	F4350018
332	F1274033-310	332	F1278006-310	422	F1315030-310	422	F1317030-310	414	F4350030
332	F1275001	332	F1278012	422	F1315033	422	F1317033	414	F4350033
332	F1275001-300	332	F1278012-300	422	F1315033-300	422	F1317033-300	414	F4351001
332	F1275001-310	332	F1278012-310	422	F1315033-310	422	F1317033-310	414	F4351006
332	F1275006	332	F1278018	422	F1315087	422	F1317087	414	F4351012
332	F1275006-300	332	F1278018-300	422	F1315087-300	422	F1317087-300	414	F4351018
332	F1275006-310	332	F1278018-310	422	F1315087-310	422	F1317087-310	414	F4351030
332	F1275012	332	F1278030	422	F1315089	422	F1317089	414	F4351033
332	F1275012-300	332	F1278030-300	422	F1315089-300	422	F1317089-300	414	F4352001
332	F1275012-310	332	F1278030-310	422	F1315089-310	422	F1317089-310	414	F4352006
332	F1275018	332	F1278033	422	F1315090	422	F1317090	414	F4352012

Page	Reference	Page	Reference	Page	Reference	Page	Reference	Page	Reference
414	F4352018	415	F4356006	478	F4570065.A	477	F4581048-300.A	477	F4586048-300.A
414	F4352030	415	F4356006-300	478	F4571045.A	477	F4581048-310.A	477	F4586048-310.A
414	F4352033	415	F4356006-310	478	F4571048.A	477	F4581048.A	477	F4586048.A
414	F4353001	415	F4356012	478	F4571056.A	477	F4581056-300.A	477	F4586056-300.A
414	F4353001-300	415	F4356012-300	478	F4571065.A	477	F4581056-310.A	477	F4586056-310.A
414	F4353001-310	415	F4356012-310	478	F4572045.A	477	F4581056.A	477	F4586056.A
414	F4353006	415	F4356018	478	F4572048.A	477	F4581065-300.A	477	F4586065-300.A
414	F4353006-300	415	F4356018-300	478	F4572056.A	477	F4581065-310.A	477	F4586065-310.A
414	F4353006-310	415	F4356018-310	478	F4573065.A	477	F4581065.A	477	F4586065.A
414	F4353012	415	F4356030	478	F4573045.A	477	F4582045-300.A	477	F4587045-300.A
414	F4353012-300	415	F4356030-300	478	F4573048.A	477	F4582045-310.A	477	F4587045-310.A
414	F4353012-310	415	F4356030-310	478	F4573056.A	477	F4582045.A	477	F4587045.A
414	F4353018	415	F4356033	478	F4573065.A	477	F4582048-300.A	477	F4587048-300.A
414	F4353018-300	415	F4356033-300	478	F4574045.A	477	F4582048-310.A	477	F4587048-310.A
414	F4353018-310	415	F4356033-310	478	F4574048.A	477	F4582048.A	477	F4587048.A
414	F4353030	415	F4357001	478	F4574056.A	477	F4582056-300.A	477	F4587056-300.A
414	F4353030-300	415	F4357001-300	478	F4574065.A	477	F4582056-310.A	477	F4587056-310.A
414	F4353030-310	415	F4357001-310	478	F4575045.A	477	F4582056.A	477	F4587056.A
414	F4353033	415	F4357006	478	F4575048.A	477	F4582065-300.A	477	F4587065-300.A
414	F4353033-300	415	F4357006-300	478	F4575056.A	477	F4582065-310.A	477	F4587065-310.A
414	F4353033-310	415	F4357006-310	478	F4575065.A	477	F4582065.A	477	F4587065.A
414	F4354001	415	F4357012	478	F4576045.A	477	F4583045-300.A	476	F4588045-300.A
414	F4354001-300	415	F4357012-300	478	F4576048.A	477	F4583045-310.A	476	F4588045-310.A
414	F4354001-310	415	F4357012-310	478	F4576056.A	477	F4583045.A	476	F4588045.A
414	F4354006	415	F4357018	478	F4576065.A	477	F4583048-300.A	476	F4588048-300.A
414	F4354006-300	415	F4357018-300	478	F4577045.A	477	F4583048-310.A	476	F4588048-310.A
414	F4354006-310	415	F4357018-310	478	F4577048.A	477	F4583048.A	476	F4588048.A
414	F4354012	415	F4357030	478	F4577056.A	477	F4583056-300.A	476	F4588056-300.A
414	F4354012-300	415	F4357030-300	478	F4577065.A	477	F4583056-310.A	476	F4588056-310.A
414	F4354012-310	415	F4357030-310	478	F4578045.A	477	F4583056.A	476	F4588056.A
414	F4354018	415	F4357033	478	F4578048.A	477	F4583065-300.A	476	F4588065-300.A
414	F4354018-300	415	F4357033-300	478	F4578056.A	477	F4583065-310.A	476	F4588065-310.A
414	F4354018-310	415	F4357033-310	478	F4578065.A	477	F4583065.A	476	F4588065.A
414	F4354030	415	F4358001	477	F4579045-300.A	477	F4584045-300.A	476	F4589045-300.A
414	F4354030-300	415	F4358001-300	477	F4579045-310.A	477	F4584045-310.A	476	F4589045-310.A
414	F4354030-310	415	F4358001-310	477	F4579045.A	477	F4584045.A	476	F4589045.A
414	F4354033	415	F4358006	477	F4579048-300.A	477	F4584048-300.A	476	F4589048-300.A
414	F4354033-300	415	F4358006-300	477	F4579048-310.A	477	F4584048-310.A	476	F4589048-310.A
414	F4354033-310	415	F4358006-310	477	F4579048.A	477	F4584048.A	476	F4589048.A
414	F4355001	415	F4358012	477	F4579056-300.A	477	F4584056-300.A	476	F4589056-300.A
414	F4355001-300	415	F4358012-300	477	F4579056-310.A	477	F4584056-310.A	476	F4589056-310.A
414	F4355001-310	415	F4358012-310	477	F4579056.A	477	F4584056.A	476	F4589056.A
414	F4355006	415	F4358018	477	F4579065-300.A	477	F4584065-300.A	476	F4589065-300.A
414	F4355006-300	415	F4358018-300	477	F4579065-310.A	477	F4584065-310.A	476	F4589065-310.A
414	F4355006-310	415	F4358018-310	477	F4579065.A	477	F4584065.A	476	F4589065.A
414	F4355012	415	F4358030	477	F4580045-300.A	477	F4585045-300.A	476	F4590045-300.A
414	F4355012-300	415	F4358030-300	477	F4580045-310.A	477	F4585045-310.A	476	F4590045-310.A
414	F4355012-310	415	F4358030-310	477	F4580045.A	477	F4585045.A	476	F4590045.A
414	F4355018	415	F4358033	477	F4580048-300.A	477	F4585048-300.A	476	F4590048-300.A
414	F4355018-300	415	F4358033-300	477	F4580048-310.A	477	F4585048-310.A	476	F4590048-310.A
414	F4355018-310	415	F4358033-310	477	F4580048.A	477	F4585048.A	476	F4590048.A
414	F4355030	479	F4555000	477	F4580056-300.A	477	F4585056-300.A	476	F4590056-300.A
414	F4355030-300	479	F4556000	477	F4580056-310.A	477	F4585056-310.A	476	F4590056-310.A
414	F4355030-310	479	F4557000	477	F4580056.A	477	F4585056.A	476	F4590056.A
414	F4355033	479	F4558000	477	F4580065-300.A	477	F4585065-300.A	476	F4590065-300.A
414	F4355033-300	479	F4559000	477	F4580065-310.A	477	F4585065-310.A	476	F4590065-310.A
414	F4355033-310	479	F4560000	477	F4580065.A	477	F4585065.A	476	F4590065.A
415	F4356001	478	F4570045.A	477	F4581045-300.A	477	F4586045-300.A	476	F4591045-300.A
415	F4356001-300	478	F4570048.A	477	F4581045-310.A	477	F4586045-310.A	476	F4591045-310.A
415	F4356001-310	478	F4570056.A	477	F4581045.A	477	F4586045.A	476	F4591045.A

Page	Reference	Page	Reference	Page	Reference	Page	Reference	Page	Reference
476	F4591048-300.A	476	F4596048-300.A	308	F990B16A000	536	FA100181133	741	FA1051071201
476	F4591048-310.A	476	F4596048-310.A	308	F990B17A000	532	FA100181140	741	FA1051071206
476	F4591048.A	476	F4596048.A	308	F990B18A000	536	FA100181141	741	FA1051071212
476	F4591056-300.A	476	F4596056-300.A	459	F990B21A000	533	FA10018212	741	FA1051071218
476	F4591056-310.A	476	F4596056-310.A	541	F990B22A000	534	FA100182122	741	FA1051071230
476	F4591056.A	476	F4596056.A	343	F990B23AZ00	538	FA100182125	741	FA1051071233
476	F4591065-300.A	476	F4596065-300.A	309	F990B27A000	537	FA100182130	741	FA1051071270
476	F4591065-310.A	476	F4596065-310.A	309	F990B28A000	537	FA100182132	741	FA1051072001
476	F4591065.A	476	F4596065.A	406	F990B29A000	533	FA10018230	741	FA1051072006
476	F4592045-300.A	479	F4597000	64	F990C00A000	533	FA10018240	741	FA1051072012
476	F4592045-310.A	479	F4598000	64	F990C010000	537	FA10018241	741	FA1051072018
476	F4592045.A	479	F4599000	67	F990C030000	772	FA100501	741	FA1051072030
476	F4592048-300.A	404	F5960044	396	F990C040000	772	FA100506	741	FA1051072033
476	F4592048-310.A	404	F5960047	308	F990C050000	772	FA100512	741	FA1051072070
476	F4592048.A	404	F5960055	67	F990C080000	772	FA100518	741	FA1051072101
476	F4592056-300.A	404	F5960066	603	F990C081000	772	FA100530	741	FA1051072106
476	F4592056-310.A	404	F5961044	603	F990C082000	772	FA100533	741	FA1051072112
476	F4592056.A	404	F5961047	603	F990C083000	772	FA100901	741	FA1051072118
476	F4592065-300.A	404	F5961055	64	F990C100000	772	FA100906	741	FA1051072130
476	F4592065-310.A	404	F5961066	66	F990C110000	772	FA100912	741	FA1051072133
476	F4592065.A	405	F5962000	708	F990E00A000	772	FA100918	741	FA1051072170
476	F4593045-300.A	404	F5970044	155	F990G300000	772	FA100930	741	FA1051072201
476	F4593045-310.A	404	F5970047	342	F990H010000	772	FA100933	741	FA1051072206
476	F4593045.A	404	F5970055	534	FA10017412	539	FA101	741	FA1051072212
476	F4593048-300.A	404	F5970066	535	FA100174122	539	FA102	741	FA1051072218
476	F4593048-310.A	404	F5971044	539	FA100174125	683	FA1022290001	741	FA1051072230
476	F4593048.A	404	F5971047	538	FA100174132	683	FA1022290006	741	FA1051072233
476	F4593056-300.A	404	F5971055	534	FA10017440	683	FA1022290012	741	FA1051072270
476	F4593056-310.A	404	F5971066	538	FA10017441	683	FA1022290018	738	FA1051440001.A
476	F4593056.A	404	F5980044	532	FA100176118	683	FA1022290030	738	FA1051440006.A
476	F4593065-300.A	404	F5980047	532	FA10017612	683	FA1022290033	738	FA1051440012.A
476	F4593065-310.A	404	F5980055	536	FA100176124	683	FA102950001	738	FA1051440018.A
476	F4593065.A	404	F5980066	536	FA100176133	683	FA102950006	738	FA1051440030.A
476	F4594045-300.A	404	F5981044	532	FA10017640	683	FA102950012	738	FA1051440033.A
476	F4594045-310.A	404	F5981047	536	FA10017641	683	FA102950018	738	FA1051440070.A
476	F4594045.A	404	F5981055	532	FA100177118	683	FA102950030	738	FA1051441201.A
476	F4594048-300.A	404	F5981066	532	FA10017712	683	FA102950033	738	FA1051441206.A
476	F4594048-310.A	291	F6268022	536	FA100177124	683	FA102960001	738	FA1051441212.A
476	F4594048.A	291	F6268041	536	FA100177133	683	FA102960006	738	FA1051441218.A
476	F4594056-300.A	291	F6367022	532	FA10017740	683	FA102960012	738	FA1051441230.A
476	F4594056-310.A	291	F6367041	536	FA10017741	683	FA102960018	738	FA1051441233.A
476	F4594056.A	290	F6468022	533	FA10017912	683	FA102960030	738	FA1051441270.A
476	F4594065-300.A	290	F6468041	534	FA100179122	683	FA102960033	738	FA1051442001.A
476	F4594065-310.A	290	F6469022	538	FA100179125	386	FA1041040090	738	FA1051442006.A
476	F4594065.A	290	F6469041	537	FA100179130	386	FA1041060090	738	FA1051442012.A
476	F4595045-300.A	308	F990B00A000	537	FA100179132	386	FA1041970090	738	FA1051442018.A
476	F4595045-310.A	308	F990B01A000	533	FA10017930	741	FA1051070001	738	FA1051442030.A
476	F4595045.A	308	F990B02A000	533	FA10017940	741	FA1051070006	738	FA1051442033.A
476	F4595048-300.A	308	F990B03A000	537	FA10017941	741	FA1051070012	738	FA1051442070.A
476	F4595048-310.A	308	F990B04A000	533	FA10018012	741	FA1051070018	738	FA1051442201.A
476	F4595048.A	308	F990B05A000	534	FA100180122	741	FA1051070030	738	FA1051442206.A
476	F4595056-300.A	625	F990B07A000	538	FA100180125	741	FA1051070033	738	FA1051442212.A
476	F4595056-310.A	624	F990B08A000	537	FA100180130	741	FA1051070070	738	FA1051442218.A
476	F4595056.A	625	F990B09A000	537	FA100180132	741	FA1051071101	738	FA1051442230.A
476	F4595065-300.A	541	F990B10A000	533	FA10018030	741	FA1051071106	738	FA1051442233.A
476	F4595065-310.A	541	F990B11A000	533	FA10018040	741	FA1051071112	738	FA1051442270.A
476	F4595065.A	541	F990B12A000	537	FA10018041	741	FA1051071118	738	FA1051710001.A
476	F4596045-300.A	541	F990B13A000	532	FA100181118	741	FA1051071130	738	FA1051710006.A
476	F4596045-310.A	625	F990B14A000	532	FA10018112	741	FA1051071133	738	FA1051710012.A
476	F4596045.A	624	F990B15A000	536	FA100181124	741	FA1051071170	738	FA1051710018.A

Page	Reference	Page	Reference	Page	Reference	Page	Reference	Page	Reference
738	FA1051710030.A	741	FA1051900012	744	FA1052522230	760	FA10526614557	779	FA11333
738	FA1051710033.A	741	FA1051900018	744	FA1052522233	760	FA10526614757	779	FA11406
738	FA1051710070.A	741	FA1051900030	744	FA1052522270	740	FA105560001	779	FA11433
738	FA1051711201.A	741	FA1051900033	743	FA1052540001	740	FA105560006	779	FA11506
738	FA1051711206.A	741	FA1051900070	743	FA1052540006	740	FA105560012	779	FA11533
738	FA1051711212.A	741	FA1051901101	743	FA1052540012	740	FA105560018	155	FA116
738	FA1051711218.A	741	FA1051901106	743	FA1052540018	740	FA105560030	772	FA11701
738	FA1051711230.A	741	FA1051901112	743	FA1052540030	740	FA105560033	772	FA11706
738	FA1051711233.A	741	FA1051901118	743	FA1052540033	740	FA105560070	772	FA11712
738	FA1051711270.A	741	FA1051901130	743	FA1052540070	740	FA105561101	772	FA11718
758	FA10517114357.A	741	FA1051901133	743	FA1052541201	740	FA105561106	772	FA11730
758	FA10517114557.A	741	FA1051901170	743	FA1052541206	740	FA105561112	772	FA11733
740	FA1051720001	741	FA1051901201	743	FA1052541212	740	FA105561118	746	FA129
740	FA1051720006	741	FA1051901206	743	FA1052541218	740	FA105561130	746	FA135
740	FA1051720012	741	FA1051901212	743	FA1052541230	740	FA105561133	449	FA136
740	FA1051720018	741	FA1051901218	743	FA1052541233	740	FA105561170	396	FA139
740	FA1051720030	741	FA1051901230	743	FA1052541270	740	FA105561201	793	FA15701
740	FA1051720033	741	FA1051901233	743	FA1052550001	740	FA105561206	793	FA15706
740	FA1051720070	741	FA1051901270	743	FA1052550006	740	FA105561212	793	FA15712
740	FA1051721101	760	FA10521114557	743	FA1052550012	740	FA105561218	793	FA15718
740	FA1051721106	760	FA10521114757	743	FA1052550018	740	FA105561230	793	FA15730
740	FA1051721112	744	FA1052510001	743	FA1052550030	740	FA105561233	793	FA15733
740	FA1051721118	744	FA1052510006	743	FA1052550033	740	FA105561270	793	FA15801
740	FA1051721130	744	FA1052510012	743	FA1052550070	740	FA105562001	793	FA15806
740	FA1051721133	744	FA1052510018	743	FA1052551201	740	FA105562006	793	FA15812
740	FA1051721170	744	FA1052510030	743	FA1052551206	740	FA105562012	793	FA15818
740	FA1051721201	744	FA1052510033	743	FA1052551212	740	FA105562018	793	FA15830
740	FA1051721206	744	FA1052510070	743	FA1052551218	740	FA105562030	793	FA15833
740	FA1051721212	744	FA1052511201	743	FA1052551230	740	FA105562033	684	FA160
740	FA1051721218	744	FA1052511206	743	FA1052551233	740	FA105562070	795	FA16101
740	FA1051721230	744	FA1052511212	743	FA1052551270	740	FA105562101	771	FA161011201
740	FA1051721233	744	FA1052511218	743	FA1052552001	740	FA105562106	771	FA161011206
740	FA1051721270	744	FA1052511230	743	FA1052552006	740	FA105562112	771	FA161011212
759	FA10517214457	744	FA1052511233	743	FA1052552012	740	FA105562118	771	FA161011218
759	FA10517214657	744	FA1052511270	743	FA1052552018	740	FA105562130	771	FA161011230
739	FA1051730001.A	744	FA1052520001	743	FA1052552030	740	FA105562133	771	FA161011233
739	FA1051730006.A	744	FA1052520006	743	FA1052552033	740	FA105562170	771	FA161011301
739	FA1051730012.A	744	FA1052520012	743	FA1052552070	740	FA105562201	771	FA161011306
739	FA1051730018.A	744	FA1052520018	743	FA1052552201	740	FA105562206	771	FA161011312
739	FA1051730030.A	744	FA1052520030	743	FA1052552206	740	FA105562212	771	FA161011318
739	FA1051730033.A	744	FA1052520033	743	FA1052552212	740	FA105562218	771	FA161011330
739	FA1051730070.A	744	FA1052520070	743	FA1052552218	740	FA105562230	771	FA161011333
758	FA10517314357.A	744	FA1052521201	743	FA1052552230	740	FA105562233	771	FA161012201
742	FA1051740001	744	FA1052521206	743	FA1052552233	740	FA105562270	771	FA161012206
742	FA1051740006	744	FA1052521212	743	FA1052552270	387	FA109	771	FA161012212
742	FA1051740012	744	FA1052521218	745	FA1052560001	772	FA110501	771	FA161012218
742	FA1051740018	744	FA1052521230	745	FA1052560006	772	FA110506	771	FA161012230
742	FA1051740030	744	FA1052521233	745	FA1052560012	772	FA110512	771	FA161012233
742	FA1051740033	744	FA1052521270	745	FA1052560018	772	FA110518	771	FA161012301
742	FA1051740070	744	FA1052522001	745	FA1052560030	772	FA110530	771	FA161012306
742	FA1051741201	744	FA1052522006	745	FA1052560033	772	FA110533	771	FA161012312
742	FA1051741206	744	FA1052522012	745	FA1052560070	772	FA110901	771	FA161012318
742	FA1051741212	744	FA1052522018	745	FA1052561201	772	FA110906	771	FA161012330
742	FA1051741218	744	FA1052522030	745	FA1052561206	772	FA110912	771	FA161012333
742	FA1051741230	744	FA1052522033	745	FA1052561212	772	FA110918	795	FA16106
742	FA1051741233	744	FA1052522070	745	FA1052561218	772	FA110930	795	FA16112
742	FA1051741270	744	FA1052522201	745	FA1052561230	772	FA110933	795	FA16118
759	FA10517414457	744	FA1052522206	745	FA1052561233	779	FA11206	795	FA16130
741	FA1051900001	744	FA1052522212	745	FA1052561270	779	FA11233	795	FA16133
741	FA1051900006	744	FA1052522218	761	FA10525614557	779	FA11306	795	FA16201

Page	Reference	Page	Reference	Page	Reference	Page	Reference	Page	Reference
795	FA16206	795	FA17701	775	FA22333	395	FA50300406.A	394	FA50320806
795	FA16212	795	FA17706	775	FA22406	395	FA50300412.A	394	FA50320812
795	FA16218	795	FA17712	775	FA22433	395	FA50300418.A	394	FA50320818
771	FA162241201	795	FA17718	774	FA22506	395	FA50300430.A	394	FA50320830
771	FA162241206	795	FA17730	774	FA22533	395	FA50300433.A	394	FA50320833
771	FA162241212	795	FA17733	774	FA22606	394	FA50300601.A	453	FA50700201
771	FA162241218	795	FA17801	774	FA22633	394	FA50300606.A	453	FA50700206
771	FA162241230	795	FA17806	774	FA22706	394	FA50300612.A	453	FA50700212
771	FA162241233	795	FA17812	774	FA22733	394	FA50300618.A	453	FA50700218
771	FA162241301	795	FA17818	774	FA22806	394	FA50300630.A	453	FA50700230
771	FA162241306	795	FA17830	774	FA22833	394	FA50300633.A	453	FA50700233
771	FA162241312	795	FA17833	775	FA22906	394	FA50300801	453	FA50700301
771	FA162241318	798	FA17901	775	FA22933	394	FA50300806	453	FA50700306
771	FA162241330	798	FA17906	775	FA23006	394	FA50300812	453	FA50700312
771	FA162241333	798	FA17912	775	FA23033	394	FA50300818	453	FA50700318
795	FA16230	798	FA17918	775	FA23106	394	FA50300830	453	FA50700330
795	FA16233	798	FA17930	775	FA23133	394	FA50300833	453	FA50700333
770	FA162801301.A	798	FA17933	775	FA23206	395	FA50300901	453	FA50700501
770	FA162801306.A	798	FA18001	775	FA23233	395	FA50300906	453	FA50700506
770	FA162801312.A	798	FA18006	757	FA235	395	FA50300912	453	FA50700512
770	FA162801318.A	798	FA18012	747	FA238.A	395	FA50300918	453	FA50700518
770	FA162801330.A	798	FA18018	747	FA239.A	395	FA50300930	453	FA50700530
770	FA162801333.A	798	FA18030	774	FA243	395	FA50300933	453	FA50700533
770	FA162801401.A	798	FA18033	684	FA24501	395	FA50301001.A	453	FA50701201
770	FA162801406.A	807	FA18101	684	FA24506	395	FA50301006.A	453	FA50701206
770	FA162801412.A	807	FA18106	684	FA24512	395	FA50301012.A	453	FA50701212
770	FA162801418.A	807	FA18112	684	FA24518	395	FA50301018.A	453	FA50701218
770	FA162801430.A	807	FA18118	684	FA24530	395	FA50301030.A	453	FA50701230
770	FA162801433.A	807	FA18130	684	FA24533	395	FA50301033.A	453	FA50701233
770	FA162811301	807	FA18133	684	FA247	394	FA50301101.A	453	FA50701301
770	FA162811306	795	FA182	155	FA24806	394	FA50301106.A	453	FA50701306
770	FA162811312	746	FA184	155	FA24833	394	FA50301112.A	453	FA50701312
770	FA162811318	378	FA185.A	155	FA24906	394	FA50301118.A	453	FA50701318
770	FA162811330	516	FA192	155	FA24933	394	FA50301130.A	453	FA50701330
770	FA162811333	516	FA193	155	FA25006	394	FA50301133.A	453	FA50701333
770	FA162811401	516	FA194	155	FA25033	394	FA50301201.A	453	FA50701501
770	FA162811406	516	FA195	155	FA25106	394	FA50301206.A	453	FA50701506
770	FA162811412	708	FA196	155	FA25133	394	FA50301212.A	453	FA50701512
770	FA162811418	708	FA197	728	FA26130	394	FA50301218.A	453	FA50701518
770	FA162811430	708	FA198	728	FA26230	394	FA50301230.A	453	FA50701530
770	FA162811433	708	FA199	728	FA26330	394	FA50301233.A	453	FA50701533
770	FA162812301.A	729	FA203	717	FA264	395	FA50320201	454	FA50702201
770	FA162812306.A	728	FA20530	717	FA266	395	FA50320206	454	FA50702206
770	FA162812312.A	728	FA20630	717	FA268	395	FA50320212	454	FA50702212
770	FA162812318.A	728	FA20730	155	FA414006	395	FA50320218	454	FA50702218
770	FA162812330.A	728	FA20830	155	FA414033	395	FA50320230	454	FA50702230
770	FA162812333.A	728	FA20930	155	FA414506	395	FA50320233	454	FA50702233
770	FA162812401.A	378	FA21	155	FA414533	395	FA50320401	454	FA50702301
770	FA162812406.A	728	FA21030	155	FA415006	395	FA50320406	454	FA50702306
770	FA162812412.A	728	FA21130	155	FA415033	395	FA50320412	454	FA50702312
770	FA162812418.A	728	FA21230	155	FA415506	395	FA50320418	454	FA50702318
770	FA162812430.A	728	FA21330	155	FA415533	395	FA50320430	454	FA50702330
770	FA162812433.A	747	FA218	493	FA50	395	FA50320433	454	FA50702333
799	FA16530	517	FA219	395	FA50300201.A	394	FA50320601	454	FA50702501
799	FA16630	517	FA220	395	FA50300206.A	394	FA50320606	454	FA50702506
807	FA16730	775	FA22106	395	FA50300212.A	394	FA50320612	454	FA50702512
807	FA16830	775	FA22133	395	FA50300218.A	394	FA50320618	454	FA50702518
664	FA172	775	FA22206	395	FA50300230.A	394	FA50320630	454	FA50702530
664	FA173	775	FA22233	395	FA50300233.A	394	FA50320633	454	FA50702533
664	FA174	775	FA22306	395	FA50300401.A	394	FA50320801	454	FA50703201

Page	Reference	Page	Reference	Page	Reference	Page	Reference	Page	Reference
454	FA50703206	456	FA50712306	450	FA50801506	446	FA50901206	448	FA50904306
454	FA50703212	456	FA50712312	450	FA50801512	446	FA50901212	448	FA50904312
454	FA50703218	456	FA50712318	450	FA50801518	446	FA50901218	448	FA50904318
454	FA50703230	456	FA50712330	450	FA50801530	446	FA50901230	448	FA50904330
454	FA50703233	456	FA50712333	450	FA50801533	446	FA50901233	448	FA50904333
454	FA50703301	456	FA50712501	451	FA50802201	446	FA50901301	448	FA50904501
454	FA50703306	456	FA50712506	451	FA50802206	446	FA50901306	448	FA50904506
454	FA50703312	456	FA50712512	451	FA50802212	446	FA50901312	448	FA50904512
454	FA50703318	456	FA50712518	451	FA50802218	446	FA50901318	448	FA50904518
454	FA50703330	456	FA50712530	451	FA50802230	446	FA50901330	448	FA50904530
454	FA50703333	456	FA50712533	451	FA50802233	446	FA50901333	448	FA50904533
454	FA50703501	456	FA50713201	451	FA50802301	446	FA50901501	448	FA50905201
454	FA50703506	456	FA50713206	451	FA50802306	446	FA50901506	448	FA50905206
454	FA50703512	456	FA50713212	451	FA50802312	446	FA50901512	448	FA50905212
454	FA50703518	456	FA50713218	451	FA50802318	446	FA50901518	448	FA50905218
454	FA50703530	456	FA50713230	451	FA50802330	446	FA50901530	448	FA50905230
454	FA50703533	456	FA50713233	451	FA50802333	446	FA50901533	448	FA50905233
455	FA50710201	456	FA50713301	451	FA50802501	447	FA50902201	448	FA50905301
455	FA50710206	456	FA50713306	451	FA50802506	447	FA50902206	448	FA50905306
455	FA50710212	456	FA50713312	451	FA50802512	447	FA50902212	448	FA50905312
455	FA50710218	456	FA50713318	451	FA50802518	447	FA50902218	448	FA50905318
455	FA50710230	456	FA50713330	451	FA50802530	447	FA50902230	448	FA50905330
455	FA50710233	456	FA50713333	451	FA50802533	447	FA50902233	448	FA50905333
455	FA50710301	456	FA50713501	451	FA50803201	447	FA50902301	448	FA50905501
455	FA50710306	456	FA50713506	451	FA50803206	447	FA50902306	448	FA50905506
455	FA50710312	456	FA50713512	451	FA50803212	447	FA50902312	448	FA50905512
455	FA50710318	456	FA50713518	451	FA50803218	447	FA50902318	448	FA50905518
455	FA50710330	456	FA50713530	451	FA50803230	447	FA50902330	448	FA50905530
455	FA50710333	456	FA50713533	451	FA50803233	447	FA50902333	448	FA50905533
455	FA50710501	450	FA50800201	451	FA50803301	447	FA50902501	448	FA50906201
455	FA50710506	450	FA50800206	451	FA50803306	447	FA50902506	448	FA50906206
455	FA50710512	450	FA50800212	451	FA50803312	447	FA50902512	448	FA50906212
455	FA50710518	450	FA50800218	451	FA50803318	447	FA50902518	448	FA50906218
455	FA50710530	450	FA50800230	451	FA50803330	447	FA50902530	448	FA50906230
455	FA50710533	450	FA50800233	451	FA50803333	447	FA50902533	448	FA50906233
455	FA50711201	450	FA50800301	451	FA50803501	447	FA50903201	448	FA50906301
455	FA50711206	450	FA50800306	451	FA50803506	447	FA50903206	448	FA50906306
455	FA50711212	450	FA50800312	451	FA50803512	447	FA50903212	448	FA50906312
455	FA50711218	450	FA50800318	451	FA50803518	447	FA50903218	448	FA50906318
455	FA50711230	450	FA50800330	451	FA50803530	447	FA50903230	448	FA50906330
455	FA50711233	450	FA50800333	451	FA50803533	447	FA50903233	448	FA50906333
455	FA50711301	450	FA50800501	446	FA50900201	447	FA50903301	448	FA50906501
455	FA50711306	450	FA50800506	446	FA50900206	447	FA50903306	448	FA50906506
455	FA50711312	450	FA50800512	446	FA50900212	447	FA50903312	448	FA50906512
455	FA50711318	450	FA50800518	446	FA50900218	447	FA50903318	448	FA50906518
455	FA50711330	450	FA50800530	446	FA50900230	447	FA50903330	448	FA50906530
455	FA50711333	450	FA50800533	446	FA50900233	447	FA50903333	448	FA50906533
455	FA50711501	450	FA50801201	446	FA50900301	447	FA50903501	458	FA51200201
455	FA50711506	450	FA50801206	446	FA50900306	447	FA50903506	458	FA51200206
455	FA50711512	450	FA50801212	446	FA50900312	447	FA50903512	458	FA51200212
455	FA50711518	450	FA50801218	446	FA50900318	447	FA50903518	458	FA51200218
455	FA50711530	450	FA50801230	446	FA50900330	447	FA50903530	458	FA51200230
455	FA50711533	450	FA50801233	446	FA50900333	447	FA50903533	458	FA51200233
456	FA50712201	450	FA50801301	446	FA50900501	448	FA50904201	458	FA51200301
456	FA50712206	450	FA50801306	446	FA50900506	448	FA50904206	458	FA51200306
456	FA50712212	450	FA50801312	446	FA50900512	448	FA50904212	458	FA51200312
456	FA50712218	450	FA50801318	446	FA50900518	448	FA50904218	458	FA51200318
456	FA50712230	450	FA50801330	446	FA50900530	448	FA50904230	458	FA51200330
456	FA50712233	450	FA50801333	446	FA50900533	448	FA50904233	458	FA51200333
456	FA50712301	450	FA50801501	446	FA50901201	448	FA50904301	458	FA51200501

Page	Reference	Page	Reference	Page	Reference	Page	Reference	Page	Reference
458	FA51200506	751	FA51303201	754	FA51305901	751	FA51308401	501	FA51700256
458	FA51200512	751	FA51303206	754	FA51305906	751	FA51308406	501	FA51700356
458	FA51200518	751	FA51303212	754	FA51305912	751	FA51308412	501	FA51700556
458	FA51200530	751	FA51303218	754	FA51305918	751	FA51308418	501	FA51701256
458	FA51200533	751	FA51303230	754	FA51305930	751	FA51308430	501	FA51701356
458	FA51201201	751	FA51303233	754	FA51305933	751	FA51308433	501	FA51701456
458	FA51201206	751	FA51303301	754	FA51306001	751	FA51308601	501	FA51701556
458	FA51201212	751	FA51303306	754	FA51306006	751	FA51308606	501	FA51701656
458	FA51201218	751	FA51303312	754	FA51306012	751	FA51308612	501	FA51701756
458	FA51201230	751	FA51303318	754	FA51306018	751	FA51308618	522	FA51702201
458	FA51201233	751	FA51303330	754	FA51306030	751	FA51308630	522	FA51702206
458	FA51201301	751	FA51303333	754	FA51306033	751	FA51308633	522	FA51702212
458	FA51201306	752	FA51303501	754	FA51306201	752	FA51308801	522	FA51702218
458	FA51201312	752	FA51303506	754	FA51306206	752	FA51308806	522	FA51702230
458	FA51201318	752	FA51303512	754	FA51306212	752	FA51308812	522	FA51702233
458	FA51201330	752	FA51303518	754	FA51306218	752	FA51308818	522	FA51702256
458	FA51201333	752	FA51303530	754	FA51306230	752	FA51308830	522	FA51702301
458	FA51201501	752	FA51303533	754	FA51306233	752	FA51308833	522	FA51702306
458	FA51201506	752	FA51303601	754	FA51306301	752	FA51309001	522	FA51702312
458	FA51201512	752	FA51303606	754	FA51306306	752	FA51309006	522	FA51702318
458	FA51201518	752	FA51303612	754	FA51306312	752	FA51309012	522	FA51702330
458	FA51201530	752	FA51303618	754	FA51306318	752	FA51309018	522	FA51702333
458	FA51201533	752	FA51303630	754	FA51306330	752	FA51309030	522	FA51702356
746	FA5130	752	FA51303633	754	FA51306333	752	FA51309033	522	FA51702501
750	FA51300201	752	FA51303801	755	FA51306501	753	FA51309201	522	FA51702506
750	FA51300206	752	FA51303806	755	FA51306506	753	FA51309206	522	FA51702512
750	FA51300212	752	FA51303812	755	FA51306512	753	FA51309212	522	FA51702518
750	FA51300218	752	FA51303818	755	FA51306518	753	FA51309218	522	FA51702530
750	FA51300230	752	FA51303830	755	FA51306530	753	FA51309230	522	FA51702533
750	FA51300233	752	FA51303833	755	FA51306533	753	FA51309233	522	FA51702556
750	FA51300301	752	FA51303901	755	FA51306601	753	FA51309401	522	FA51703201
750	FA51300306	752	FA51303906	755	FA51306606	753	FA51309406	522	FA51703206
750	FA51300312	752	FA51303912	755	FA51306612	753	FA51309412	522	FA51703212
750	FA51300318	752	FA51303918	755	FA51306618	753	FA51309418	522	FA51703218
750	FA51300330	752	FA51303930	755	FA51306630	753	FA51309430	522	FA51703230
750	FA51300333	752	FA51303933	755	FA51306633	753	FA51309433	522	FA51703233
750	FA51301201	753	FA51304701	755	FA51306801	754	FA51309601	522	FA51703256
750	FA51301206	753	FA51304706	755	FA51306806	754	FA51309606	522	FA51703301
750	FA51301212	753	FA51304712	755	FA51306812	754	FA51309612	522	FA51703306
750	FA51301218	753	FA51304718	755	FA51306818	754	FA51309618	522	FA51703312
750	FA51301230	753	FA51304730	755	FA51306830	754	FA51309630	522	FA51703318
750	FA51301233	753	FA51304733	755	FA51306833	754	FA51309633	522	FA51703330
750	FA51301301	753	FA51304801	755	FA51306901	754	FA51309801	522	FA51703333
750	FA51301306	753	FA51304806	755	FA51306906	754	FA51309806	522	FA51703356
750	FA51301312	753	FA51304812	755	FA51306912	754	FA51309812	522	FA51703501
750	FA51301318	753	FA51304818	755	FA51306918	754	FA51309818	522	FA51703506
750	FA51301330	753	FA51304830	755	FA51306930	754	FA51309830	522	FA51703512
750	FA51301333	753	FA51304833	755	FA51306933	754	FA51309833	522	FA51703518
751	FA51302201	753	FA51305001	750	FA51308001	755	FA51310001	522	FA51703530
751	FA51302206	753	FA51305006	750	FA51308006	755	FA51310006	522	FA51703533
751	FA51302212	753	FA51305012	750	FA51308012	755	FA51310012	522	FA51703556
751	FA51302218	753	FA51305018	750	FA51308018	755	FA51310018	523	FA51704201
751	FA51302230	753	FA51305030	750	FA51308030	755	FA51310030	523	FA51704206
751	FA51302233	753	FA51305033	750	FA51308033	755	FA51310033	523	FA51704212
751	FA51302301	753	FA51305101	750	FA51308201	755	FA51310201	523	FA51704218
751	FA51302306	753	FA51305106	750	FA51308206	755	FA51310206	523	FA51704230
751	FA51302312	753	FA51305112	750	FA51308212	755	FA51310212	523	FA51704233
751	FA51302318	753	FA51305118	750	FA51308218	755	FA51310218	523	FA51704256
751	FA51302330	753	FA51305130	750	FA51308230	755	FA51310230	523	FA51704301
751	FA51302333	753	FA51305133	750	FA51308233	755	FA51310233	523	FA51704306

Page	Reference	Page	Reference	Page	Reference	Page	Reference	Page	Reference
523	FA51704312	497	FA51800256	519	FA51807201	519	FA51827212	792	FA52501333.A
523	FA51704318	497	FA51800356	519	FA51807206	519	FA51827218	792	FA52502201.A
523	FA51704330	496	FA51800556	519	FA51807212	519	FA51827230	792	FA52502206.A
523	FA51704333	496	FA51800656	519	FA51807218	519	FA51827233	792	FA52502212.A
523	FA51704356	496	FA51800856	519	FA51807230	519	FA51827256	792	FA52502218.A
523	FA51704501	496	FA51800956	519	FA51807233	520	FA51828201	792	FA52502230.A
523	FA51704506	497	FA51801256	519	FA51807256	520	FA51828206	792	FA52502233.A
523	FA51704512	497	FA51801356	519	FA51807301	520	FA51828212	792	FA52502301.A
523	FA51704518	498	FA51801556	519	FA51807306	520	FA51828218	792	FA52502306.A
523	FA51704530	498	FA51801656	519	FA51807312	520	FA51828230	792	FA52502312.A
523	FA51704533	498	FA51802256	519	FA51807318	520	FA51828233	792	FA52502318.A
523	FA51704556	498	FA51802356	519	FA51807330	520	FA51828256	792	FA52502330.A
523	FA51705201	498	FA51802556	519	FA51807333	746	FA5230	792	FA52502333.A
523	FA51705206	498	FA51802656	519	FA51807356	660	FA523002.A	794	FA52503201
523	FA51705212	498	FA51803256	520	FA51808201	660	FA523003.A	794	FA52503206
523	FA51705218	498	FA51803356	520	FA51808206	660	FA523012.A	794	FA52503212
523	FA51705230	497	FA51803456	520	FA51808212	660	FA523013.A	794	FA52503218
523	FA51705233	497	FA51803556	520	FA51808218	661	FA523022.A	794	FA52503230
523	FA51705256	518	FA51804201	520	FA51808230	661	FA523023.A	794	FA52503233
523	FA51705301	518	FA51804206	520	FA51808233	661	FA523032.A	794	FA52503301
523	FA51705306	518	FA51804212	520	FA51808256	661	FA523033.A	794	FA52503306
523	FA51705312	518	FA51804218	520	FA51808301	662	FA523042.A	794	FA52503312
523	FA51705318	518	FA51804230	520	FA51808306	662	FA523043.A	794	FA52503318
523	FA51705330	518	FA51804233	520	FA51808312	662	FA523052.A	794	FA52503330
523	FA51705333	518	FA51804256	520	FA51808318	662	FA523053.A	794	FA52503333
523	FA51705356	518	FA51804301	520	FA51808330	663	FA523062.A	794	FA52504201
523	FA51705501	518	FA51804306	520	FA51808333	663	FA523063.A	794	FA52504206
523	FA51705506	518	FA51804312	520	FA51808356	663	FA523072.A	794	FA52504212
523	FA51705512	518	FA51804318	497	FA51820256	663	FA523073.A	794	FA52504218
523	FA51705518	518	FA51804330	496	FA51820556	660	FA523203.A	794	FA52504230
523	FA51705530	518	FA51804333	496	FA51820856	660	FA523213	794	FA52504233
523	FA51705533	518	FA51804356	497	FA51821256	661	FA523223	794	FA52504301
523	FA51705556	518	FA51805201	498	FA51821556	661	FA523233	794	FA52504306
524	FA51706201	518	FA51805206	498	FA51822256	662	FA523243	794	FA52504312
524	FA51706206	518	FA51805212	498	FA51822556	662	FA523253.A	794	FA52504318
524	FA51706212	518	FA51805218	498	FA51823256	663	FA523263	794	FA52504330
524	FA51706218	518	FA51805230	497	FA51823456	663	FA523273	794	FA52504333
524	FA51706230	518	FA51805233	518	FA51824201	792	FA52500201.A	794	FA52505201
524	FA51706233	518	FA51805256	518	FA51824206	792	FA52500206.A	794	FA52505206
524	FA51706256	518	FA51805301	518	FA51824212	792	FA52500212.A	794	FA52505212
524	FA51706301	518	FA51805306	518	FA51824218	792	FA52500218.A	794	FA52505218
524	FA51706306	518	FA51805312	518	FA51824230	792	FA52500230.A	794	FA52505230
524	FA51706312	518	FA51805318	518	FA51824233	792	FA52500233.A	794	FA52505233
524	FA51706318	518	FA51805330	518	FA51824256	792	FA52500301.A	794	FA52505301
524	FA51706330	518	FA51805333	518	FA51825201	792	FA52500306.A	794	FA52505306
524	FA51706333	518	FA51805356	518	FA51825206	792	FA52500312.A	794	FA52505312
524	FA51706356	519	FA51806201	518	FA51825212	792	FA52500318.A	794	FA52505318
524	FA51706501	519	FA51806206	518	FA51825218	792	FA52500330.A	794	FA52505330
524	FA51706506	519	FA51806212	518	FA51825230	792	FA52500333.A	794	FA52505333
524	FA51706512	519	FA51806218	518	FA51825233	792	FA52501201.A	797	FA52506201
524	FA51706518	519	FA51806230	518	FA51825256	792	FA52501206.A	797	FA52506201-300
524	FA51706530	519	FA51806233	519	FA51826201	792	FA52501212.A	797	FA52506201-310
524	FA51706533	519	FA51806256	519	FA51826206	792	FA52501218.A	797	FA52506206
524	FA51706556	519	FA51806301	519	FA51826212	792	FA52501230.A	797	FA52506206-300
500	FA51711256	519	FA51806306	519	FA51826218	792	FA52501233.A	797	FA52506206-310
500	FA51711356	519	FA51806312	519	FA51826230	792	FA52501301.A	797	FA52506212
500	FA51711556	519	FA51806318	519	FA51826233	792	FA52501306.A	797	FA52506212-300
500	FA51712256	519	FA51806330	519	FA51826256	792	FA52501312.A	797	FA52506212-310
500	FA51712356	519	FA51806333	519	FA51827201	792	FA52501318.A	797	FA52506218
500	FA51712556	519	FA51806356	519	FA51827206	792	FA52501330.A	797	FA52506218-300

Page	Reference	Page	Reference	Page	Reference	Page	Reference	Page	Reference
797	FA52506218-310	797	FA52507333-310	796	FA52509306-310	803	FA52511218-310	802	FA52512333-310
797	FA52506230	796	FA52508201	796	FA52509312	803	FA52511230	804	FA52512401
797	FA52506230-300	796	FA52508201-300	796	FA52509312-300	803	FA52511230-300	804	FA52512406
797	FA52506230-310	796	FA52508201-310	796	FA52509312-310	803	FA52511230-310	804	FA52512412
797	FA52506233	796	FA52508206	796	FA52509318	803	FA52511233	804	FA52512418
797	FA52506233-300	796	FA52508206-300	796	FA52509318-300	803	FA52511233-300	804	FA52512430
797	FA52506233-310	796	FA52508206-310	796	FA52509318-310	803	FA52511233-310	804	FA52512433
797	FA52506301	796	FA52508212	796	FA52509330	803	FA52511301	802	FA52513201
797	FA52506301-300	796	FA52508212-300	796	FA52509330-300	803	FA52511301-300	802	FA52513201-300
797	FA52506301-310	796	FA52508212-310	796	FA52509330-310	803	FA52511301-310	802	FA52513201-310
797	FA52506306	796	FA52508218	796	FA52509333	803	FA52511306	802	FA52513206
797	FA52506306-300	796	FA52508218-300	796	FA52509333-300	803	FA52511306-300	802	FA52513206-300
797	FA52506306-310	796	FA52508218-310	796	FA52509333-310	803	FA52511306-310	802	FA52513206-310
797	FA52506312	796	FA52508230	803	FA52510201	803	FA52511312	802	FA52513212
797	FA52506312-300	796	FA52508230-300	803	FA52510201-300	803	FA52511312-300	802	FA52513212-300
797	FA52506312-310	796	FA52508230-310	803	FA52510201-310	803	FA52511312-310	802	FA52513212-310
797	FA52506318	796	FA52508233	803	FA52510206	803	FA52511318	802	FA52513218
797	FA52506318-300	796	FA52508233-300	803	FA52510206-300	803	FA52511318-300	802	FA52513218-300
797	FA52506318-310	796	FA52508233-310	803	FA52510206-310	803	FA52511318-310	802	FA52513218-310
797	FA52506330	796	FA52508301	803	FA52510212	803	FA52511330	802	FA52513230
797	FA52506330-300	796	FA52508301-300	803	FA52510212-300	803	FA52511330-300	802	FA52513230-300
797	FA52506330-310	796	FA52508301-310	803	FA52510212-310	803	FA52511330-310	802	FA52513230-310
797	FA52506333	796	FA52508306	803	FA52510218	803	FA52511333	802	FA52513233
797	FA52506333-300	796	FA52508306-300	803	FA52510218-300	803	FA52511333-300	802	FA52513233-300
797	FA52506333-310	796	FA52508306-310	803	FA52510218-310	803	FA52511333-310	802	FA52513233-310
797	FA52507201	796	FA52508312	803	FA52510230	802	FA52512201	802	FA52513301
797	FA52507201-300	796	FA52508312-300	803	FA52510230-300	802	FA52512201-300	802	FA52513301-300
797	FA52507201-310	796	FA52508312-310	803	FA52510230-310	802	FA52512201-310	802	FA52513301-310
797	FA52507206	796	FA52508318	803	FA52510233	802	FA52512206	802	FA52513306
797	FA52507206-300	796	FA52508318-300	803	FA52510233-300	802	FA52512206-300	802	FA52513306-300
797	FA52507206-310	796	FA52508318-310	803	FA52510233-310	802	FA52512206-310	802	FA52513306-310
797	FA52507212	796	FA52508330	803	FA52510301	802	FA52512212	802	FA52513312
797	FA52507212-300	796	FA52508330-300	803	FA52510301-300	802	FA52512212-300	802	FA52513312-300
797	FA52507212-310	796	FA52508330-310	803	FA52510301-310	802	FA52512212-310	802	FA52513312-310
797	FA52507218	796	FA52508333	803	FA52510306	802	FA52512218	802	FA52513318
797	FA52507218-300	796	FA52508333-300	803	FA52510306-300	802	FA52512218-300	802	FA52513318-300
797	FA52507218-310	796	FA52508333-310	803	FA52510306-310	802	FA52512218-310	802	FA52513318-310
797	FA52507230	796	FA52509201	803	FA52510312	802	FA52512230	802	FA52513330
797	FA52507230-300	796	FA52509201-300	803	FA52510312-300	802	FA52512230-300	802	FA52513330-300
797	FA52507230-310	796	FA52509201-310	803	FA52510312-310	802	FA52512230-310	802	FA52513330-310
797	FA52507233	796	FA52509206	803	FA52510318	802	FA52512233	802	FA52513333
797	FA52507233-300	796	FA52509206-300	803	FA52510318-300	802	FA52512233-300	802	FA52513333-300
797	FA52507233-310	796	FA52509206-310	803	FA52510318-310	802	FA52512233-310	802	FA52513333-310
797	FA52507301	796	FA52509212	803	FA52510330	802	FA52512301	792	FA52514001.A
797	FA52507301-300	796	FA52509212-300	803	FA52510330-300	802	FA52512301-300	792	FA52514006.A
797	FA52507301-310	796	FA52509212-310	803	FA52510330-310	802	FA52512301-310	792	FA52514012.A
797	FA52507306	796	FA52509218	803	FA52510333	802	FA52512306	792	FA52514018.A
797	FA52507306-300	796	FA52509218-300	803	FA52510333-300	802	FA52512306-300	792	FA52514030.A
797	FA52507306-310	796	FA52509218-310	803	FA52510333-310	802	FA52512306-310	792	FA52514033.A
797	FA52507312	796	FA52509230	803	FA52511201	802	FA52512312	792	FA52514201.A
797	FA52507312-300	796	FA52509230-300	803	FA52511201-300	802	FA52512312-300	792	FA52514206.A
797	FA52507312-310	796	FA52509230-310	803	FA52511201-310	802	FA52512312-310	792	FA52514212.A
797	FA52507318	796	FA52509233	803	FA52511206	802	FA52512318	792	FA52514218.A
797	FA52507318-300	796	FA52509233-300	803	FA52511206-300	802	FA52512318-300	792	FA52514230.A
797	FA52507318-310	796	FA52509233-310	803	FA52511206-310	802	FA52512318-310	792	FA52514233.A
797	FA52507330	796	FA52509301	803	FA52511212	802	FA52512330	792	FA52514401.A
797	FA52507330-300	796	FA52509301-300	803	FA52511212-300	802	FA52512330-300	792	FA52514406.A
797	FA52507330-310	796	FA52509301-310	803	FA52511212-310	802	FA52512330-310	792	FA52514412.A
797	FA52507333	796	FA52509306	803	FA52511218	802	FA52512333	792	FA52514418.A
797	FA52507333-300	796	FA52509306-300	803	FA52511218-300	802	FA52512333-300	792	FA52514430.A

Page	Reference	Page	Reference	Page	Reference	Page	Reference	Page	Reference
792	FA52514433.A	797	FA52515606-310	802	FA52516218-310	673	FA52600533.A	376	FA53200233-300.B
794	FA52514601	797	FA52515612	802	FA52516230	682	FA52700201	376	FA53200233-310.A
794	FA52514606	797	FA52515612-300	802	FA52516230-300	682	FA52700206	376	FA53200233.A
794	FA52514612	797	FA52515612-310	802	FA52516230-310	682	FA52700212	376	FA53200301-300.B
794	FA52514618	797	FA52515618	802	FA52516233	682	FA52700218	376	FA53200301-310.A
794	FA52514630	797	FA52515618-300	802	FA52516233-300	682	FA52700230	376	FA53200301.A
794	FA52514633	797	FA52515618-310	802	FA52516233-310	682	FA52700233	376	FA53200306-300.B
794	FA52514801	797	FA52515630	803	FA52516401	682	FA52700301	376	FA53200306-310.A
794	FA52514806	797	FA52515630-300	803	FA52516401-300	682	FA52700306	376	FA53200306.A
794	FA52514812	797	FA52515630-310	803	FA52516401-310	682	FA52700312	376	FA53200312-300.B
794	FA52514818	797	FA52515633	803	FA52516406	682	FA52700318	376	FA53200312-310.A
794	FA52514830	797	FA52515633-300	803	FA52516406-300	682	FA52700330	376	FA53200312.A
794	FA52514833	797	FA52515633-310	803	FA52516406-310	682	FA52700333	376	FA53200318-300.B
794	FA52515001	797	FA52515801	803	FA52516412	682	FA52700501	376	FA53200318-310.A
794	FA52515006	797	FA52515801-300	803	FA52516412-300	682	FA52700506	376	FA53200318.A
794	FA52515012	797	FA52515801-310	803	FA52516412-310	682	FA52700512	376	FA53200330-300.B
794	FA52515018	797	FA52515806	803	FA52516418	682	FA52700518	376	FA53200330-310.A
794	FA52515030	797	FA52515806-300	803	FA52516418-300	682	FA52700530	376	FA53200330.A
794	FA52515033	797	FA52515806-310	803	FA52516418-310	682	FA52700533	376	FA53200333-300.B
796	FA52515201	797	FA52515812	803	FA52516430	682	FA52701201	376	FA53200333-310.A
796	FA52515201-300	797	FA52515812-300	803	FA52516430-300	682	FA52701206	376	FA53200333.A
796	FA52515201-310	797	FA52515812-310	803	FA52516430-310	682	FA52701212	376	FA53200501-300.B
796	FA52515206	797	FA52515818	803	FA52516433	682	FA52701218	376	FA53200501-310.A
796	FA52515206-300	797	FA52515818-300	803	FA52516433-300	682	FA52701230	376	FA53200501.A
796	FA52515206-310	797	FA52515818-310	803	FA52516433-310	682	FA52701233	376	FA53200506-300.B
796	FA52515212	797	FA52515830	803	FA52516601	682	FA52701301	376	FA53200506-310.A
796	FA52515212-300	797	FA52515830-300	803	FA52516601-300	682	FA52701306	376	FA53200506.A
796	FA52515212-310	797	FA52515830-310	803	FA52516601-310	682	FA52701312	376	FA53200512-300.B
796	FA52515218	797	FA52515833	803	FA52516606	682	FA52701318	376	FA53200512-310.A
796	FA52515218-300	797	FA52515833-300	803	FA52516606-300	682	FA52701330	376	FA53200512.A
796	FA52515218-310	797	FA52515833-310	803	FA52516606-310	682	FA52701333	376	FA53200518-300.B
796	FA52515230	802	FA52516001	803	FA52516612	682	FA52701501	376	FA53200518-310.A
796	FA52515230-300	802	FA52516001-300	803	FA52516612-300	682	FA52701506	376	FA53200518.A
796	FA52515230-310	802	FA52516001-310	803	FA52516612-310	682	FA52701512	376	FA53200530-300.B
796	FA52515233	802	FA52516006	803	FA52516618	682	FA52701518	376	FA53200530-310.A
796	FA52515233-300	802	FA52516006-300	803	FA52516618-300	682	FA52701530	376	FA53200530.A
796	FA52515233-310	802	FA52516006-310	803	FA52516618-310	682	FA52701533	376	FA53200533-300.B
796	FA52515401	802	FA52516012	803	FA52516630	493	FA53000256.A	376	FA53200533-310.A
796	FA52515401-300	802	FA52516012-300	803	FA52516630-300	493	FA53000356.A	376	FA53200533.A
796	FA52515401-310	802	FA52516012-310	803	FA52516630-310	494	FA53000556	376	FA53200601-300.B
796	FA52515406	802	FA52516018	803	FA52516633	494	FA53000656	376	FA53200601-310.A
796	FA52515406-300	802	FA52516018-300	803	FA52516633-300	493	FA53000756.A	376	FA53200601.A
796	FA52515406-310	802	FA52516018-310	803	FA52516633-310	493	FA53000856.A	376	FA53200606-300.B
796	FA52515412	802	FA52516030	673	FA52600201.A	494	FA53000956	376	FA53200606-310.A
796	FA52515412-300	802	FA52516030-300	673	FA52600206.A	494	FA53001056	376	FA53200606.A
796	FA52515412-310	802	FA52516030-310	673	FA52600212.A	376	FA53200201-300.B	376	FA53200612-300.B
796	FA52515418	802	FA52516033	673	FA52600218.A	376	FA53200201-310.A	376	FA53200612-310.A
796	FA52515418-300	802	FA52516033-300	673	FA52600230.A	376	FA53200201.A	376	FA53200612.A
796	FA52515418-310	802	FA52516033-310	673	FA52600233.A	376	FA53200206-300.B	376	FA53200618-300.B
796	FA52515430	802	FA52516201	673	FA52600301.A	376	FA53200206-310.A	376	FA53200618-310.A
796	FA52515430-300	802	FA52516201-300	673	FA52600306.A	376	FA53200206.A	376	FA53200618.A
796	FA52515430-310	802	FA52516201-310	673	FA52600312.A	376	FA53200212-300.B	376	FA53200630-300.B
796	FA52515433	802	FA52516206	673	FA52600318.A	376	FA53200212-310.A	376	FA53200630-310.A
796	FA52515433-300	802	FA52516206-300	673	FA52600330.A	376	FA53200212.A	376	FA53200630.A
796	FA52515433-310	802	FA52516206-310	673	FA52600333.A	376	FA53200218-300.B	376	FA53200633-300.B
797	FA52515601	802	FA52516212	673	FA52600501.A	376	FA53200218-310.A	376	FA53200633-310.A
797	FA52515601-300	802	FA52516212-300	673	FA52600506.A	376	FA53200218.A	376	FA53200633.A
797	FA52515601-310	802	FA52516212-310	673	FA52600512.A	376	FA53200230-300.B	377	FA53200801-300.B
797	FA52515606	802	FA52516218	673	FA52600518.A	376	FA53200230-310.A	377	FA53200801-310.A
797	FA52515606-300	802	FA52516218-300	673	FA52600530.A	376	FA53200230.A	377	FA53200801.A

Page	Reference	Page	Reference	Page	Reference	Page	Reference	Page	Reference
377	FA53200806-300.B	376	FA53201718-300.B	694	FA53301206	694	FA53305106	695	FA533332
377	FA53200806-310.A	376	FA53201718-310.A	694	FA53301206-300	694	FA53305106-300	695	FA533332-300
377	FA53200806.A	376	FA53201718.A	694	FA53301206-310	694	FA53305106-310	695	FA533332-310
377	FA53200812-300.B	376	FA53201730-300.B	694	FA53301212	694	FA53305112	695	FA533333
377	FA53200812-310.A	376	FA53201730-310.A	694	FA53301212-300	694	FA53305112-300	695	FA533333-300
377	FA53200812.A	376	FA53201730.A	694	FA53301212-310	694	FA53305112-310	695	FA533333-310
377	FA53200818-300.B	376	FA53201733-300.B	694	FA53301218	694	FA53305118	695	FA533334
377	FA53200818-310.A	376	FA53201733-310.A	694	FA53301218-300	694	FA53305118-300	695	FA533334-300
377	FA53200818.A	376	FA53201733.A	694	FA53301218-310	694	FA53305118-310	695	FA533334-310
377	FA53200830-300.B	377	FA53202001-300.B	694	FA53301230	694	FA53305130	694	FA533341
377	FA53200830-310.A	377	FA53202001-310.A	694	FA53301230-300	694	FA53305130-300	694	FA533341-300
377	FA53200830.A	377	FA53202001.A	694	FA53301230-310	694	FA53305130-310	694	FA533341-310
377	FA53200833-300.B	377	FA53202006-300.B	694	FA53301233	694	FA53305133	695	FA533342
377	FA53200833-310.A	377	FA53202006-310.A	694	FA53301233-300	694	FA53305133-300	695	FA533342-300
377	FA53200833.A	377	FA53202006.A	694	FA53301233-310	694	FA53305133-310	695	FA533342-310
377	FA53200901-300.B	377	FA53202012-300.B	692	FA53302101	692	FA53305201	695	FA533343
377	FA53200901-310.A	377	FA53202012-310.A	692	FA53302101-300	692	FA53305201-300	695	FA533343-300
377	FA53200901.A	377	FA53202012.A	692	FA53302101-310	692	FA53305201-310	695	FA533343-310
377	FA53200906-300.B	377	FA53202018-300.B	692	FA53302106	692	FA53305206	695	FA533344
377	FA53200906-310.A	377	FA53202018-310.A	692	FA53302106-300	692	FA53305206-300	695	FA533344-300
377	FA53200906.A	377	FA53202018.A	692	FA53302106-310	692	FA53305206-310	695	FA533344-310
377	FA53200912-300.B	377	FA53202030-300.B	692	FA53302112	692	FA53305212	692	FA533421
377	FA53200912-310.A	377	FA53202030-310.A	692	FA53302112-300	692	FA53305212-300	692	FA533421-300
377	FA53200912.A	377	FA53202030.A	692	FA53302112-310	692	FA53305212-310	692	FA533421-310
377	FA53200918-300.B	377	FA53202033-300.B	692	FA53302118	692	FA53305218	693	FA533422
377	FA53200918-310.A	377	FA53202033-310.A	692	FA53302118-300	692	FA53305218-300	693	FA533422-300
377	FA53200918.A	377	FA53202033.A	692	FA53302118-310	692	FA53305218-310	693	FA533422-310
377	FA53200930-300.B	696	FA53300101	692	FA53302130	692	FA53305230	693	FA533423
377	FA53200930-310.A	696	FA53300106	692	FA53302130-300	692	FA53305230-300	693	FA533423-300
377	FA53200930.A	696	FA53300112	692	FA53302130-310	692	FA53305230-310	693	FA533423-310
377	FA53200933-300.B	696	FA53300118	692	FA53302133	692	FA53305233	693	FA533424
377	FA53200933-310.A	696	FA53300130	692	FA53302133-300	692	FA53305233-300	693	FA533424-300
377	FA53200933.A	696	FA53300133	692	FA53302133-310	692	FA53305233-310	693	FA533424-310
376	FA53201401-300.B	696	FA53300201	692	FA53302201	696	FA533221	692	FA533431
376	FA53201401-310.A	696	FA53300206	692	FA53302201-300	696	FA533222	692	FA533431-300
376	FA53201401.A	696	FA53300212	692	FA53302201-310	697	FA533223	692	FA533431-310
376	FA53201406-300.B	696	FA53300218	692	FA53302206	697	FA533224	693	FA533432
376	FA53201406-310.A	696	FA53300230	692	FA53302206-300	696	FA533231	693	FA533432-300
376	FA53201406.A	696	FA53300233	692	FA53302206-310	696	FA533232	693	FA533432-310
376	FA53201412-300.B	694	FA53301101	692	FA53302212	697	FA533233	693	FA533433
376	FA53201412-310.A	694	FA53301101-300	692	FA53302212-300	697	FA533234	693	FA533433-300
376	FA53201412.A	694	FA53301101-310	692	FA53302212-310	696	FA533241	693	FA533433-310
376	FA53201418-300.B	694	FA53301106	692	FA53302218	696	FA533242	693	FA533434
376	FA53201418-310.A	694	FA53301106-300	692	FA53302218-300	697	FA533243	693	FA533434-300
376	FA53201418.A	694	FA53301106-310	692	FA53302218-310	697	FA533244	693	FA533434-310
376	FA53201430-300.B	694	FA53301112	692	FA53302230	694	FA533321	692	FA533441
376	FA53201430-310.A	694	FA53301112-300	692	FA53302230-300	694	FA533321-300	692	FA533441-300
376	FA53201430.A	694	FA53301112-310	692	FA53302230-310	694	FA533321-310	692	FA533441-310
376	FA53201433-300.B	694	FA53301118	692	FA53302233	695	FA533322	693	FA533442
376	FA53201433-310.A	694	FA53301118-300	692	FA53302233-300	695	FA533322-300	693	FA533442-300
376	FA53201433.A	694	FA53301118-310	692	FA53302233-310	695	FA533322-310	693	FA533442-310
376	FA53201701-300.B	694	FA53301130	696	FA53305001	695	FA533323	693	FA533443
376	FA53201701-310.A	694	FA53301130-300	696	FA53305006	695	FA533323-300	693	FA533443-300
376	FA53201701.A	694	FA53301130-310	696	FA53305012	695	FA533323-310	693	FA533443-310
376	FA53201706-300.B	694	FA53301133	696	FA53305018	695	FA533324	693	FA533444
376	FA53201706-310.A	694	FA53301133-300	696	FA53305030	695	FA533324-300	693	FA533444-300
376	FA53201706.A	694	FA53301133-310	696	FA53305033	695	FA533324-310	693	FA533444-310
376	FA53201712-300.B	694	FA53301201	694	FA53305101	694	FA533331	490	FA53400256.A
376	FA53201712-310.A	694	FA53301201-300	694	FA53305101-300	694	FA533331-300	490	FA53400356.A
376	FA53201712.A	694	FA53301201-310	694	FA53305101-310	694	FA533331-310	490	FA53400556.A

Page	Reference	Page	Reference	Page	Reference	Page	Reference	Page	Reference
490	FA53400656.A	486	FA53404356	511	FA53500301	514	FA53501801	512	FA53503301
490	FA53400856.A	486	FA53404356-300	511	FA53500306	514	FA53501806	512	FA53503306
490	FA53400956.A	486	FA53404356-310	511	FA53500312	514	FA53501812	512	FA53503312
491	FA53401156.A	487	FA53404556	511	FA53500318	514	FA53501818	512	FA53503318
491	FA53401256.A	487	FA53404556-300	511	FA53500330	514	FA53501830	512	FA53503330
491	FA53401456	487	FA53404556-310	511	FA53500333	514	FA53501833	512	FA53503333
491	FA53401556	487	FA53404656	513	FA53500501	511	FA53502001	514	FA53503501
491	FA53401756	487	FA53404656-300	513	FA53500506	511	FA53502006	514	FA53503506
491	FA53401856	487	FA53404656-310	513	FA53500512	511	FA53502012	514	FA53503512
488	FA53402056	487	FA53404756	513	FA53500518	511	FA53502018	514	FA53503518
488	FA53402056-300	487	FA53404756-300	513	FA53500530	511	FA53502030	514	FA53503530
488	FA53402056-310	487	FA53404756-310.A	513	FA53500533	511	FA53502033	514	FA53503533
488	FA53402156	487	FA53404856-300.A	513	FA53500601	511	FA53502101	514	FA53503601
488	FA53402156-300	487	FA53404856-310.A	513	FA53500606	511	FA53502106	514	FA53503606
488	FA53402156-310	487	FA53404856.A	513	FA53500612	511	FA53502112	514	FA53503612
488	FA53402356	490	FA53405156.A	513	FA53500618	511	FA53502118	514	FA53503618
488	FA53402356-300	490	FA53405256.A	513	FA53500630	511	FA53502130	514	FA53503630
488	FA53402356-310	490	FA53405356.A	513	FA53500633	511	FA53502133	514	FA53503633
488	FA53402456	491	FA53405456.A	515	FA53500801	513	FA53502301	511	FA53504101
488	FA53402456-300	491	FA53405556	515	FA53500806	513	FA53502306	511	FA53504106
488	FA53402456-310	491	FA53405656	515	FA53500812	513	FA53502312	511	FA53504112
488	FA53402656	488	FA53405756	515	FA53500818	513	FA53502318	511	FA53504118
488	FA53402656-300	488	FA53405756-300	515	FA53500830	513	FA53502330	511	FA53504130
488	FA53402656-310	488	FA53405756-310	515	FA53500833	513	FA53502333	511	FA53504133
488	FA53402756	488	FA53405856	515	FA53500901	513	FA53502401	511	FA53504201
488	FA53402756-300	488	FA53405856-300	515	FA53500906	513	FA53502406	511	FA53504206
488	FA53402756-310	488	FA53405856-310	515	FA53500912	513	FA53502412	511	FA53504212
489	FA53402956	488	FA53405956	515	FA53500918	513	FA53502418	511	FA53504218
489	FA53402956-300	488	FA53405956-300	515	FA53500930	513	FA53502430	511	FA53504230
489	FA53402956-310	488	FA53405956-310	515	FA53500933	513	FA53502433	511	FA53504233
489	FA53403056	489	FA53406056	510	FA53501101	515	FA53502601	513	FA53504301
489	FA53403056-300	489	FA53406056-300	510	FA53501106	515	FA53502606	513	FA53504306
489	FA53403056-310	489	FA53406056-310	510	FA53501112	515	FA53502612	513	FA53504312
489	FA53403156-300.B	489	FA53406156-300.B	510	FA53501118	515	FA53502618	513	FA53504318
489	FA53403156-310.A	489	FA53406156-310.A	510	FA53501130	515	FA53502630	513	FA53504330
489	FA53403156.A	489	FA53406156.A	510	FA53501133	515	FA53502633	513	FA53504333
489	FA53403256	489	FA53406256-300.B	510	FA53501201	515	FA53502701	513	FA53504401
489	FA53403256-300.A	489	FA53406256-310.A	510	FA53501206	515	FA53502706	513	FA53504406
489	FA53403256-310	489	FA53406256.A	510	FA53501212	515	FA53502712	513	FA53504412
489	FA53403356-300.B	486	FA53406356	510	FA53501218	515	FA53502718	513	FA53504418
489	FA53403356-310.A	486	FA53406356-300	510	FA53501230	515	FA53502730	513	FA53504430
489	FA53403356.A	486	FA53406356-310	510	FA53501233	515	FA53502733	513	FA53504433
489	FA53403456	486	FA53406456	512	FA53501401	510	FA53502901	515	FA53504501
489	FA53403456-300.A	486	FA53406456-300	512	FA53501406	510	FA53502906	515	FA53504506
489	FA53403456-310	486	FA53406456-310	512	FA53501412	510	FA53502912	515	FA53504512
486	FA53403656	486	FA53406556	512	FA53501418	510	FA53502918	515	FA53504518
486	FA53403656-300	486	FA53406556-300	512	FA53501430	510	FA53502930	515	FA53504530
486	FA53403656-310	486	FA53406556-310	512	FA53501433	510	FA53502933	515	FA53504533
486	FA53403756	487	FA53406656	512	FA53501501	510	FA53503001	515	FA53504601
486	FA53403756-300	487	FA53406656-300	512	FA53501506	510	FA53503006	515	FA53504606
486	FA53403756-310	487	FA53406656-310	512	FA53501512	510	FA53503012	515	FA53504612
486	FA53403956	487	FA53406756-300.A	512	FA53501518	510	FA53503018	515	FA53504618
486	FA53403956-300	487	FA53406756-310.A	512	FA53501530	510	FA53503030	515	FA53504630
486	FA53403956-310	487	FA53406756.A	512	FA53501533	510	FA53503033	515	FA53504633
486	FA53404056	511	FA53500201	514	FA53501701	512	FA53503201	510	FA53504701
486	FA53404056-300	511	FA53500206	514	FA53501706	512	FA53503206	510	FA53504706
486	FA53404056-310	511	FA53500212	514	FA53501712	512	FA53503212	510	FA53504712
486	FA53404256	511	FA53500218	514	FA53501718	512	FA53503218	510	FA53504718
486	FA53404256-300	511	FA53500230	514	FA53501730	512	FA53503230	510	FA53504730
486	FA53404256-310	511	FA53500233	514	FA53501733	512	FA53503233	510	FA53504733

Page	Reference	Page	Reference	Page	Reference	Page	Reference	Page	Reference
510	FA53504801	705	FA53602056-300	706	FA53604001-300.A	705	FA53611856	821	FA53900206
510	FA53504806	705	FA53602056-310	706	FA53604001-310	705	FA53611856-300	821	FA53900206-300
510	FA53504812	705	FA53602101-300.A	706	FA53604101-300.B	705	FA53611856-310	821	FA53900206-310
510	FA53504818	705	FA53602101-310.A	706	FA53604101-310.A	705	FA53612056	821	FA53900233
510	FA53504830	705	FA53602101.A	706	FA53604101.A	705	FA53612056-300	821	FA53900233-300
510	FA53504833	705	FA53602201	706	FA53604201	705	FA53612056-310	821	FA53900233-310
512	FA53504901	705	FA53602201-300	706	FA53604201-300.A	705	FA53612201-300.A	821	FA53900306
512	FA53504906	705	FA53602201-310	706	FA53604201-310	705	FA53612201-310.A	821	FA53900306-300
512	FA53504912	705	FA53602301-300.A	706	FA53604301-300.B	705	FA53612201.A	821	FA53900306-310
512	FA53504918	705	FA53602301-310.A	706	FA53604301-310.A	705	FA53612401-300.A	821	FA53900333
512	FA53504930	705	FA53602301.A	706	FA53604301.A	705	FA53612401-310.A	821	FA53900333-300
512	FA53504933	705	FA53602401	706	FA53604401	705	FA53612401.A	821	FA53900333-310
512	FA53505001	705	FA53602401-300	706	FA53604401-300.A	705	FA53612601	821	FA53900506
512	FA53505006	705	FA53602401-310	706	FA53604401-310	705	FA53612601-300	821	FA53900506-300
512	FA53505012	705	FA53602501	707	FA53604756-300.A	705	FA53612601-310	821	FA53900506-310
512	FA53505018	705	FA53602501-300	707	FA53604756-310.A	705	FA53612801	821	FA53900533
512	FA53505030	705	FA53602501-310	707	FA53604756.A	705	FA53612801-300	821	FA53900533-300
512	FA53505033	705	FA53602601	707	FA53604856-300.A	705	FA53612801-310	821	FA53900533-310
514	FA53505101	705	FA53602601-300	707	FA53604856-310.A	706	FA53613056-300.B	821	FA53900606
514	FA53505106	705	FA53602601-310	707	FA53604856.A	706	FA53613056-310.B	821	FA53900606-300
514	FA53505112	705	FA53602701	707	FA53604956-300.A	706	FA53613056.A	821	FA53900606-310
514	FA53505118	705	FA53602701-300	707	FA53604956-310.A	706	FA53613256-300.B	821	FA53900633
514	FA53505130	705	FA53602701-310	707	FA53604956.A	706	FA53613256-310.A	821	FA53900633-300
514	FA53505133	705	FA53602801	707	FA53605056-300.A	706	FA53613256.A	821	FA53900633-310
514	FA53505201	705	FA53602801-300	707	FA53605056-310.A	706	FA53613456-300.B	821	FA53900806
514	FA53505206	705	FA53602801-310	707	FA53605056.A	706	FA53613456-310.A	821	FA53900806-300
514	FA53505212	706	FA53602956-300.B	707	FA53605156-300.A	706	FA53613456.A	821	FA53900806-310
514	FA53505218	706	FA53602956-310.A	707	FA53605156-310.A	706	FA53613656-300.B	821	FA53900833
514	FA53505230	706	FA53602956.A	707	FA53605156.A	706	FA53613656-310.A	821	FA53900833-300
514	FA53505233	706	FA53603056	707	FA53605256-300.A	706	FA53613656.A	821	FA53900833-310
704	FA53600256	706	FA53603056-300.B	707	FA53605256-310.A	706	FA53613801-300.B	821	FA53900906
704	FA53600356	706	FA53603056-310	707	FA53605256.A	706	FA53613801-310.A	821	FA53900906-300
704	FA53600556	706	FA53603156-300.B	707	FA53605501-300.A	706	FA53613801.A	821	FA53900906-310
704	FA53600656	706	FA53603156-310.A	707	FA53605501-310.A	706	FA53614001-300.B	821	FA53900933
704	FA53600801	706	FA53603156.A	707	FA53605501.A	706	FA53614001-310.A	821	FA53900933-300
704	FA53600901	706	FA53603256	707	FA53605601-300.A	706	FA53614001.A	821	FA53900933-310
704	FA53601101	706	FA53603256-300.A	707	FA53605601-310.A	706	FA53614201-300.A	822	FA53901106
704	FA53601201	706	FA53603256-310	707	FA53605601.A	706	FA53614201-310.A	822	FA53901106-300
705	FA53601356-300.A	706	FA53603356-300.A	707	FA53605701-300.A	706	FA53614201.A	822	FA53901106-310
705	FA53601356-310.A	706	FA53603356-310.A	707	FA53605701-310.A	706	FA53614401-300.B	822	FA53901133
705	FA53601356.A	706	FA53603356.A	707	FA53605701.A	706	FA53614401-310.B	822	FA53901133-300
705	FA53601456	706	FA53603456	707	FA53605801-300.A	706	FA53614401.A	822	FA53901133-310
705	FA53601456-300	706	FA53603456-300.A	707	FA53605801-310.A	707	FA53614856-300.A	822	FA53901206
705	FA53601456-310	706	FA53603456-310.A	707	FA53605801.A	707	FA53614856-310.A	822	FA53901206-300
705	FA53601556-300.A	706	FA53603556-300.B	707	FA53605901-300.A	707	FA53614856.A	822	FA53901206-310
705	FA53601556-310.A	706	FA53603556-310.A	707	FA53605901-310.A	707	FA53615056-300.A	822	FA53901233
705	FA53601556.A	706	FA53603556.A	707	FA53605901.A	707	FA53615056-310.A	822	FA53901233-300
705	FA53601656	706	FA53603656	707	FA53606001-300.A	707	FA53615056.A	822	FA53901233-310
705	FA53601656-300	706	FA53603656-300.B	707	FA53606001-310.A	707	FA53615256-300.A	822	FA53901406
705	FA53601656-310	706	FA53603656-310	707	FA53606001.A	707	FA53615256-310.A	822	FA53901406-300
705	FA53601756	706	FA53603701-300.B	704	FA53610356	707	FA53615256.A	822	FA53901406-310
705	FA53601756-300	706	FA53603701-310.A	704	FA53610656	707	FA53615601-300.A	822	FA53901433
705	FA53601756-310	706	FA53603701.A	704	FA53610901	707	FA53615601-310.A	822	FA53901433-300
705	FA53601856	706	FA53603801	704	FA53611201	707	FA53615601.A	822	FA53901433-310
705	FA53601856-300	706	FA53603801-300.A	705	FA53611456-300.A	707	FA53615801-300.A	822	FA53901506
705	FA53601856-310	706	FA53603801-310	705	FA53611456-310.A	707	FA53615801-310.A	822	FA53901506-300
705	FA53601956	706	FA53603901-300.B	705	FA53611456.A	707	FA53615801.A	822	FA53901506-310
705	FA53601956-300	706	FA53603901-310.A	705	FA53611656-300.A	707	FA53616001-300.A	822	FA53901533
705	FA53601956-310	706	FA53603901.A	705	FA53611656-310.A	707	FA53616001-310.A	822	FA53901533-300
705	FA53602056	706	FA53604001	705	FA53611656.A	707	FA53616001.A	822	FA53901533-310

Page	Reference	Page	Reference	Page	Reference	Page	Reference	Page	Reference
822	FA53901706	824	FA53903206	818	FA53904706	819	FA53906206	816	FA53907606
822	FA53901706-300	824	FA53903206-300	818	FA53904706-300	819	FA53906206-300	816	FA53907606-300
822	FA53901706-310	824	FA53903206-310	818	FA53904706-310	819	FA53906206-310	816	FA53907606-310
822	FA53901733	824	FA53903233	818	FA53904733	819	FA53906233	816	FA53907633
822	FA53901733-300	824	FA53903233-300	818	FA53904733-300	819	FA53906233-300	816	FA53907633-300
822	FA53901733-310	824	FA53903233-310	818	FA53904733-310	819	FA53906233-310	816	FA53907633-310
822	FA53901806	824	FA53903306	818	FA53904806	819	FA53906306	817	FA53907806
822	FA53901806-300	824	FA53903306-300	818	FA53904806-300	819	FA53906306-300	817	FA53907806-300
822	FA53901806-310	824	FA53903306-310	818	FA53904806-310	819	FA53906306-310	817	FA53907806-310
822	FA53901833	824	FA53903333	818	FA53904833	819	FA53906333	817	FA53907833
822	FA53901833-300	824	FA53903333-300	818	FA53904833-300	819	FA53906333-300	817	FA53907833-300
822	FA53901833-310	824	FA53903333-310	818	FA53904833-310	819	FA53906333-310	817	FA53907833-310
823	FA53902006	824	FA53903506	818	FA53905006	820	FA53906506	817	FA53908006
823	FA53902006-300	824	FA53903506-300	818	FA53905006-300	820	FA53906506-300	817	FA53908006-300
823	FA53902006-310	824	FA53903506-310	818	FA53905006-310	820	FA53906506-310	817	FA53908006-310
823	FA53902033	824	FA53903533	818	FA53905033	820	FA53906533	817	FA53908033
823	FA53902033-300	824	FA53903533-300	818	FA53905033-300	820	FA53906533-300	817	FA53908033-300
823	FA53902033-310	824	FA53903533-310	818	FA53905033-310	820	FA53906533-310	817	FA53908033-310
823	FA53902106	824	FA53903606	818	FA53905106	820	FA53906606	817	FA53908206
823	FA53902106-300	824	FA53903606-300	818	FA53905106-300	820	FA53906606-300	817	FA53908206-300
823	FA53902106-310	824	FA53903606-310	818	FA53905106-310	820	FA53906606-310	817	FA53908206-310
823	FA53902133	824	FA53903633	818	FA53905133	820	FA53906633	817	FA53908233
823	FA53902133-300	824	FA53903633-300	818	FA53905133-300	820	FA53906633-300	817	FA53908233-300
823	FA53902133-310	824	FA53903633-310	818	FA53905133-310	820	FA53906633-310	817	FA53908233-310
823	FA53902306	817	FA53903806	818	FA53905306	820	FA53906806	818	FA53908406
823	FA53902306-300	817	FA53903806-300	818	FA53905306-300	820	FA53906806-300	818	FA53908406-300
823	FA53902306-310	817	FA53903806-310	818	FA53905306-310	820	FA53906806-310	818	FA53908406-310
823	FA53902333	817	FA53903833	818	FA53905333	820	FA53906833	818	FA53908433
823	FA53902333-300	817	FA53903833-300	818	FA53905333-300	820	FA53906833-300	818	FA53908433-300
823	FA53902333-310	817	FA53903833-310	818	FA53905333-310	820	FA53906833-310	818	FA53908433-310
823	FA53902406	817	FA53903906	818	FA53905406	820	FA53906906	818	FA53908606
823	FA53902406-300	817	FA53903906-300	818	FA53905406-300	820	FA53906906-300	818	FA53908606-300
823	FA53902406-310	817	FA53903906-310	818	FA53905406-310	820	FA53906906-310	818	FA53908606-310
823	FA53902433	817	FA53903933	818	FA53905433	820	FA53906933	818	FA53908633
823	FA53902433-300	817	FA53903933-300	818	FA53905433-300	820	FA53906933-300	818	FA53908633-300
823	FA53902433-310	817	FA53903933-310	818	FA53905433-310	820	FA53906933-310	818	FA53908633-310
823	FA53902606	817	FA53904106	819	FA53905606	820	FA53907106	818	FA53908806
823	FA53902606-300	817	FA53904106-300	819	FA53905606-300	820	FA53907106-300	818	FA53908806-300
823	FA53902606-310	817	FA53904106-310	819	FA53905606-310	820	FA53907106-310	818	FA53908806-310
823	FA53902633	817	FA53904133	819	FA53905633	820	FA53907133	818	FA53908833
823	FA53902633-300	817	FA53904133-300	819	FA53905633-300	820	FA53907133-300	818	FA53908833-300
823	FA53902633-310	817	FA53904133-310	819	FA53905633-310	820	FA53907133-310	818	FA53908833-310
823	FA53902706	817	FA53904206	819	FA53905706	820	FA53907206	819	FA53909006
823	FA53902706-300	817	FA53904206-300	819	FA53905706-300	820	FA53907206-300	819	FA53909006-300
823	FA53902706-310	817	FA53904206-310	819	FA53905706-310	820	FA53907206-310	819	FA53909006-310
823	FA53902733	817	FA53904233	819	FA53905733	820	FA53907233	819	FA53909033
823	FA53902733-300	817	FA53904233-300	819	FA53905733-300	820	FA53907233-300	819	FA53909033-300
823	FA53902733-310	817	FA53904233-310	819	FA53905733-310	820	FA53907233-310	819	FA53909033-310
824	FA53902906	817	FA53904406	819	FA53905906	816	FA53907406	819	FA53909206
824	FA53902906-300	817	FA53904406-300	819	FA53905906-300	816	FA53907406-300	819	FA53909206-300
824	FA53902906-310	817	FA53904406-310	819	FA53905906-310	816	FA53907406-310	819	FA53909206-310
824	FA53902933	817	FA53904433	819	FA53905933	816	FA53907433	819	FA53909233
824	FA53902933-300	817	FA53904433-300	819	FA53905933-300	816	FA53907433-300	819	FA53909233-300
824	FA53902933-310	817	FA53904433-310	819	FA53905933-310	816	FA53907433-310	819	FA53909233-310
824	FA53903006	817	FA53904506	819	FA53906006	816	FA53907506	819	FA53909406
824	FA53903006-300	817	FA53904506-300	819	FA53906006-300	816	FA53907506-300	819	FA53909406-300
824	FA53903006-310	817	FA53904506-310	819	FA53906006-310	816	FA53907506-310	819	FA53909406-310
824	FA53903033	817	FA53904533	819	FA53906033	816	FA53907533	819	FA53909433
824	FA53903033-300	817	FA53904533-300	819	FA53906033-300	816	FA53907533-300	819	FA53909433-300
824	FA53903033-310	817	FA53904533-310	819	FA53906033-310	816	FA53907533-310	819	FA53909433-310

Page	Reference	Page	Reference	Page	Reference	Page	Reference	Page	Reference
820	FA53909606	823	FA53911606	821	FA53914006	822	FA53916006	823	FA53918006
820	FA53909606-300	823	FA53911606-300	821	FA53914006-300	822	FA53916006-300	823	FA53918006-300
820	FA53909606-310	823	FA53911606-310	821	FA53914006-310	822	FA53916006-310	823	FA53918006-310
820	FA53909633	823	FA53911633	821	FA53914033	822	FA53916033	823	FA53918033
820	FA53909633-300	823	FA53911633-300	821	FA53914033-300	822	FA53916033-300	823	FA53918033-300
820	FA53909633-310	823	FA53911633-310	821	FA53914033-310	822	FA53916033-310	823	FA53918033-310
820	FA53909806	823	FA53911806	822	FA53914206	823	FA53916206	824	FA53918206
820	FA53909806-300	823	FA53911806-300	822	FA53914206-300	823	FA53916206-300	824	FA53918206-300
820	FA53909806-310	823	FA53911806-310	822	FA53914206-310	823	FA53916206-310	824	FA53918206-310
820	FA53909833	823	FA53911833	822	FA53914233	823	FA53916233	824	FA53918233
820	FA53909833-300	823	FA53911833-300	822	FA53914233-300	823	FA53916233-300	824	FA53918233-300
820	FA53909833-310	823	FA53911833-310	822	FA53914233-310	823	FA53916233-310	824	FA53918233-310
820	FA53910006	824	FA53912006	823	FA53914406	824	FA53916406	716	FA54000101.A
820	FA53910006-300	824	FA53912006-300	823	FA53914406-300	824	FA53916406-300	716	FA54000106.A
820	FA53910006-310	824	FA53912006-310	823	FA53914406-310	824	FA53916406-310	716	FA54000112.A
820	FA53910033	824	FA53912033	823	FA53914433	824	FA53916433	716	FA54000118.A
820	FA53910033-300	824	FA53912033-300	823	FA53914433-300	824	FA53916433-300	716	FA54000130.A
820	FA53910033-310	824	FA53912033-310	823	FA53914433-310	824	FA53916433-310	716	FA54000133.A
821	FA53910206	824	FA53912206	824	FA53914606	816	FA53916606	716	FA54000201.A
821	FA53910206-300	824	FA53912206-300	824	FA53914606-300	816	FA53916606-300	716	FA54000206.A
821	FA53910206-310	824	FA53912206-310	824	FA53914606-310	816	FA53916606-310	716	FA54000212.A
821	FA53910233	824	FA53912233	824	FA53914633	816	FA53916633	716	FA54000218.A
821	FA53910233-300	824	FA53912233-300	824	FA53914633-300	816	FA53916633-300	716	FA54000230.A
821	FA53910233-310	824	FA53912233-310	824	FA53914633-310	816	FA53916633-310	716	FA54000233.A
821	FA53910406	824	FA53912406	816	FA53914806	817	FA53916806	717	FA54000301
821	FA53910406-300	824	FA53912406-300	816	FA53914806-300	817	FA53916806-300	717	FA54000306
821	FA53910406-310	824	FA53912406-310	816	FA53914806-310	817	FA53916806-310	717	FA54000312
821	FA53910433	824	FA53912433	816	FA53914833	817	FA53916833	717	FA54000318
821	FA53910433-300	824	FA53912433-300	816	FA53914833-300	817	FA53916833-300	717	FA54000330
821	FA53910433-310	824	FA53912433-310	816	FA53914833-310	817	FA53916833-310	717	FA54000333
821	FA53910606	816	FA53913006	817	FA53915006	818	FA53917006	724	FA54100201
821	FA53910606-300	816	FA53913006-300	817	FA53915006-300	818	FA53917006-300	724	FA54100206
821	FA53910606-310	816	FA53913006-310	817	FA53915006-310	818	FA53917006-310	724	FA54100212
821	FA53910633	816	FA53913033	817	FA53915033	818	FA53917033	724	FA54100218
821	FA53910633-300	816	FA53913033-300	817	FA53915033-300	818	FA53917033-300	724	FA54100230
821	FA53910633-310	816	FA53913033-310	817	FA53915033-310	818	FA53917033-310	724	FA54100233
822	FA53910806	817	FA53913206	818	FA53915206	819	FA53917206	724	FA54100301
822	FA53910806-300	817	FA53913206-300	818	FA53915206-300	819	FA53917206-300	724	FA54100306
822	FA53910806-310	817	FA53913206-310	818	FA53915206-310	819	FA53917206-310	724	FA54100312
822	FA53910833	817	FA53913233	818	FA53915233	819	FA53917233	724	FA54100318
822	FA53910833-300	817	FA53913233-300	818	FA53915233-300	819	FA53917233-300	724	FA54100330
822	FA53910833-310	817	FA53913233-310	818	FA53915233-310	819	FA53917233-310	724	FA54100333
822	FA53911006	818	FA53913406	819	FA53915406	820	FA53917406	724	FA54100501
822	FA53911006-300	818	FA53913406-300	819	FA53915406-300	820	FA53917406-300	724	FA54100506
822	FA53911006-310	818	FA53913406-310	819	FA53915406-310	820	FA53917406-310	724	FA54100512
822	FA53911033	818	FA53913433	819	FA53915433	820	FA53917433	724	FA54100518
822	FA53911033-300	818	FA53913433-300	819	FA53915433-300	820	FA53917433-300	724	FA54100530
822	FA53911033-310	818	FA53913433-310	819	FA53915433-310	820	FA53917433-310	724	FA54100533
822	FA53911206	819	FA53913606	820	FA53915606	821	FA53917606	724	FA54100601
822	FA53911206-300	819	FA53913606-300	820	FA53915606-300	821	FA53917606-300	724	FA54100606
822	FA53911206-310	819	FA53913606-310	820	FA53915606-310	821	FA53917606-310	724	FA54100612
822	FA53911233	819	FA53913633	820	FA53915633	821	FA53917633	724	FA54100618
822	FA53911233-300	819	FA53913633-300	820	FA53915633-300	821	FA53917633-300	724	FA54100630
822	FA53911233-310	819	FA53913633-310	820	FA53915633-310	821	FA53917633-310	724	FA54100633
823	FA53911406	820	FA53913806	821	FA53915806	822	FA53917806	725	FA54100701.A
823	FA53911406-300	820	FA53913806-300	821	FA53915806-300	822	FA53917806-300	725	FA54100706.A
823	FA53911406-310	820	FA53913806-310	821	FA53915806-310	822	FA53917806-310	725	FA54100712.A
823	FA53911433	820	FA53913833	821	FA53915833	822	FA53917833	725	FA54100718.A
823	FA53911433-300	820	FA53913833-300	821	FA53915833-300	822	FA53917833-300	725	FA54100730.A
823	FA53911433-310	820	FA53913833-310	821	FA53915833-310	822	FA53917833-310	725	FA54100733.A

Page	Reference	Page	Reference	Page	Reference	Page	Reference	Page	Reference
725	FA54100801.A	726	FA54101333.A	726	FA54103230.A	672	FA54200518	779	FA9033
725	FA54100806.A	726	FA54101401.A	726	FA54103233.A	672	FA54200530	778	FA9306
725	FA54100812.A	726	FA54101406.A	726	FA54103401.A	672	FA54200533	778	FA9333
725	FA54100818.A	726	FA54101412.A	726	FA54103406.A	672	FA54200601	778	FA9406
725	FA54100830.A	726	FA54101418.A	726	FA54103412.A	672	FA54200606	780	FA942842401.A
725	FA54100833.A	726	FA54101430.A	726	FA54103418.A	672	FA54200612	780	FA942842406.A
725	FA54100901.A	726	FA54101433.A	726	FA54103430.A	672	FA54200618	780	FA942842412.A
725	FA54100906.A	724	FA54102301	726	FA54103433.A	672	FA54200630	780	FA942842418.A
725	FA54100912.A	724	FA54102306	727	FA54110001	672	FA54200633	780	FA942842430.A
725	FA54100918.A	724	FA54102312	727	FA54110006	672	FA54200701	780	FA942842433.A
725	FA54100930.A	724	FA54102318	727	FA54110012	672	FA54200706	780	FA942851401.A
725	FA54100933.A	724	FA54102330	727	FA54110018	672	FA54200712	780	FA942851406.A
725	FA54101001.A	724	FA54102333	727	FA54110030	672	FA54200718	780	FA942851412.A
725	FA54101006.A	724	FA54102601	727	FA54110033	672	FA54200730	780	FA942851418.A
725	FA54101012.A	724	FA54102606	727	FA54110201	672	FA54200733	780	FA942851430.A
725	FA54101018.A	724	FA54102612	727	FA54110206	672	FA54200901	780	FA942851433.A
725	FA54101030.A	724	FA54102618	727	FA54110212	672	FA54200906	778	FA9433
725	FA54101033.A	724	FA54102630	727	FA54110218	672	FA54200912	778	FA9506
726	FA54101101.A	724	FA54102633	727	FA54110230	672	FA54200918	778	FA9533
726	FA54101106.A	725	FA54102801.A	727	FA54110233	672	FA54200930	778	FA9606
726	FA54101112.A	725	FA54102806.A	672	FA54200201	672	FA54200933	776	FA962821301.A
726	FA54101118.A	725	FA54102812.A	672	FA54200206	746	FA68	776	FA962821306.A
726	FA54101130.A	725	FA54102818.A	672	FA54200212	779	FA7806	776	FA962821312.A
726	FA54101133.A	725	FA54102830.A	672	FA54200218	779	FA7833	776	FA962821318.A
726	FA54101201.A	725	FA54102833.A	672	FA54200230	779	FA7906	776	FA962821330.A
726	FA54101206.A	725	FA54103001.A	672	FA54200233	779	FA7933	776	FA962821333.A
726	FA54101212.A	725	FA54103006.A	672	FA54200301	774	FA8801	776	FA962821401.A
726	FA54101218.A	725	FA54103012.A	672	FA54200306	774	FA8806	776	FA962821406.A
726	FA54101230.A	725	FA54103018.A	672	FA54200312	774	FA8812	776	FA962821412.A
726	FA54101233.A	725	FA54103030.A	672	FA54200318	774	FA8818	776	FA962821418.A
726	FA54101301.A	725	FA54103033.A	672	FA54200330	774	FA8830	776	FA962821430.A
726	FA54101306.A	726	FA54103201.A	672	FA54200333	774	FA8833	776	FA962821433.A
726	FA54101312.A	726	FA54103206.A	672	FA54200501	779	FA8906	776	FA962831301.A
726	FA54101318.A	726	FA54103212.A	672	FA54200506	779	FA8933	776	FA962831306.A
726	FA54101330.A	726	FA54103218.A	672	FA54200512	779	FA9006	776	FA962831312.A

Page	Reference	Page	Reference	Page	Reference	Page	Reference	Page	Reference
776	FA962831318.A	781	FA972471330-310.A	781	FA972472330	781	FA972481318-310	780	FA972841430.A
776	FA962831330.A	781	FA972471330.A	781	FA972472330-300	781	FA972481330	780	FA972841433.A
776	FA962831333.A	781	FA972471333-300.A	781	FA972472330-310	781	FA972481330-300	780	FA972842301.A
776	FA962831401.A	781	FA972471333-310.A	781	FA972472333	781	FA972481330-310	780	FA972842306.A
776	FA962831406.A	781	FA972471333.A	781	FA972472333-300	781	FA972481333	780	FA972842312.A
776	FA962831412.A	781	FA972471401-300.A	781	FA972472333-310	781	FA972481333-300	780	FA972842318.A
776	FA962831418.A	781	FA972471401-310.A	781	FA972472401	781	FA972481333-310	780	FA972842330.A
776	FA962831430.A	781	FA972471401.A	781	FA972472401-300	781	FA972481401	780	FA972842333.A
776	FA962831433.A	781	FA972471406-300.A	781	FA972472401-310	781	FA972481401-300	780	FA972851301.A
776	FA962832301.A	781	FA972471406-310.A	781	FA972472406	781	FA972481401-310	780	FA972851306.A
776	FA962832306.A	781	FA972471406.A	781	FA972472406-300	781	FA972481406	780	FA972851312.A
776	FA962832312.A	781	FA972471412-300.A	781	FA972472406-310	781	FA972481406-300	780	FA972851318.A
776	FA962832318.A	781	FA972471412-310.A	781	FA972472412	781	FA972481406-310	780	FA972851330.A
776	FA962832330.A	781	FA972471412.A	781	FA972472412-300	781	FA972481412	780	FA972851333.A
776	FA962832333.A	781	FA972471418-300.A	781	FA972472412-310	781	FA972481412-300	539	FA98
776	FA962832401.A	781	FA972471418-310.A	781	FA972472418	781	FA972481412-310	539	FA99
776	FA962832406.A	781	FA972471418.A	781	FA972472418-300	781	FA972481418	625	RF25746
776	FA962832412.A	781	FA972471430-300.A	781	FA972472418-310	781	FA972481418-300	309	RF25747
776	FA962832418.A	781	FA972471430-310.A	781	FA972472430	781	FA972481418-310	309	RF25748
776	FA962832430.A	781	FA972471430.A	781	FA972472430-300	781	FA972481430	407	RF25750
776	FA962832433.A	781	FA972471433-300.A	781	FA972472430-310	781	FA972481430-300	406	RF25752
778	FA9633	781	FA972471433-310.A	781	FA972472433	781	FA972481430-310	625	RF25753
781	FA972471301-300.A	781	FA972471433.A	781	FA972472433-300	781	FA972481433	309	RF25754
781	FA972471301-310.A	781	FA972472301	781	FA972472433-310	781	FA972481433-300	309	RF25757
781	FA972471301.A	781	FA972472301-300	781	FA972481301	781	FA972481433-310	407	RF26387.A
781	FA972471306-300.A	781	FA972472301-310	781	FA972481301-300	780	FA972841301.A	290	RF26998
781	FA972471306-310.A	781	FA972472306	781	FA972481301-310	780	FA972841306.A	256	RF32288
781	FA972471306.A	781	FA972472306-300	781	FA972481306	780	FA972841312.A	256	RF32289
781	FA972471312-300.A	781	FA972472306-310	781	FA972481306-300	780	FA972841318.A	256	RF32290
781	FA972471312-310.A	781	FA972472312	781	FA972481306-310	780	FA972841330.A	256	RF32291
781	FA972471312.A	781	FA972472312-300	781	FA972481312	780	FA972841333.A		
781	FA972471318-300.A	781	FA972472312-310	781	FA972481312-300	780	FA972841401.A		
781	FA972471318-310.A	781	FA972472318	781	FA972481312-310	780	FA972841406.A		
781	FA972471318.A	781	FA972472318-300	781	FA972481318	780	FA972841412.A		
781	FA972471330-300.A	781	FA972472318-310	781	FA972481318-300	780	FA972841418.A		

FLOS

Outdoor

Spine

16

- Spine
- Spine F
- Spine L
- Spine T

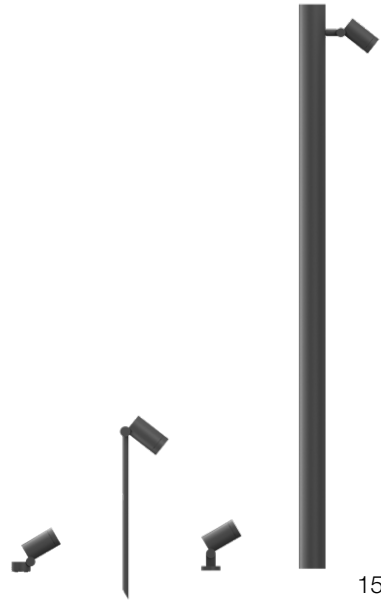

Pointbreak

156

- Pointbreak Bollard
- Pointbreak Balisage
- Pointbreak Wall
- Pointbreak Ceiling

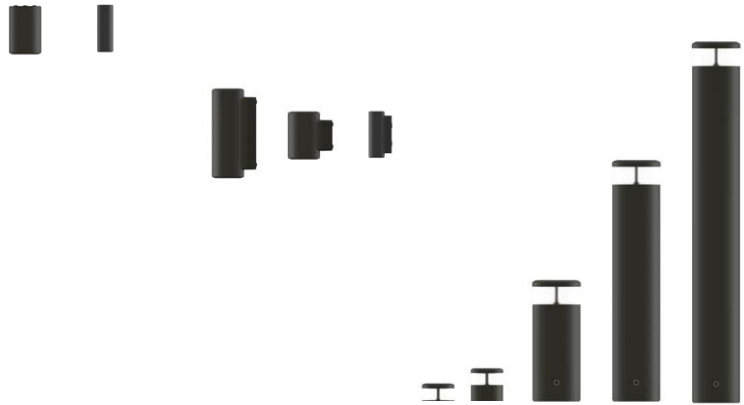

In Vitro

186

- In Vitro Bollard
- In Vitro Wall
- In Vitro Ceiling
- In Vitro Suspended
- In Vitro Unplugged





Mile

- Mile Wall
- Mile Bollard
- Mile Path
- Mile Ceiling
- Mile Recessed



Captain Flint

- Captain Flint Wall
- Captain Flint Floor
- Captain Flint Bollard

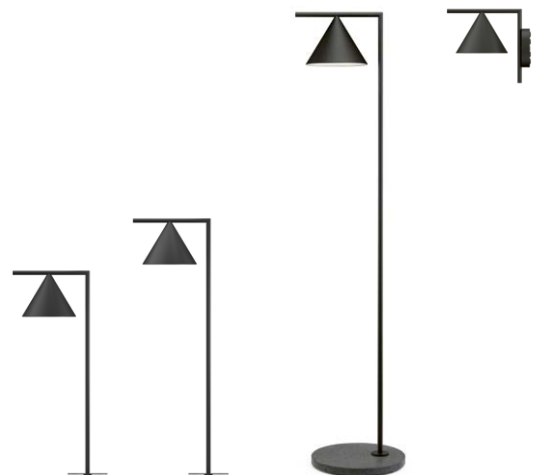

IC Light

250

IC Wall
IC Floor

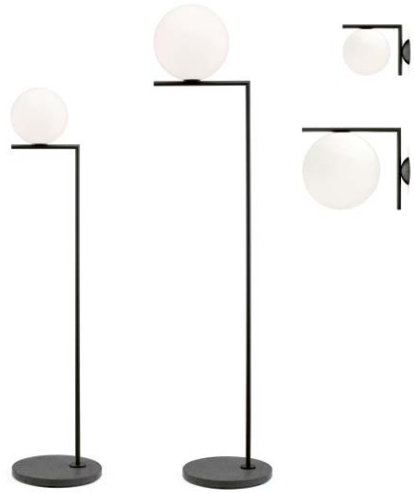

Caule

258

Caule Floor / Floor Nest
Caule Bollard / Bollard Nest

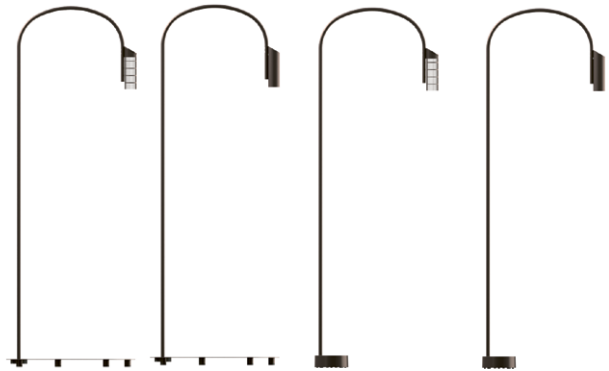

Flauta

274

Flauta Riga
Flauta Spiga

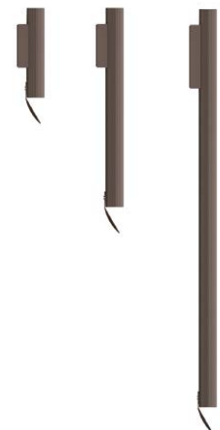

Lighting In The Rain

285

Romeo C3
 KTribe F3
 Superarchimoon



Landlord

292

Landlord Spot
 Landlord Soft
 Landlord Ground



Bellhop

310

Bellhop Wall
 Bellhop Bollard
 Bellhop Pole



Casting

322

- Casting Concrete
- Casting C
- Casting T

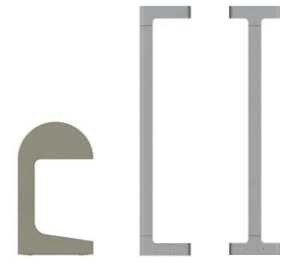

Walkstick / Wallstick

334

- Walkstick Pipe
- Walkstick
- Wallstick

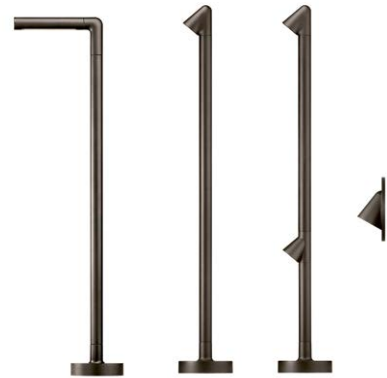

Belvedere

348

- Belvedere Clove
- Belvedere Spot
- Belvedere Wall



Klein Pro

360



Zefiro

370



I - Ron

380



Talia

388

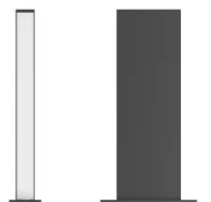

Real Matter

398

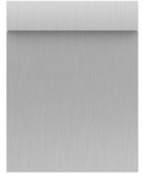

My Way

408



Camouflage

416



Climber

426



Heavy Metal

440

Heavy Metal Spot
Heavy Metal Wall





A-Round

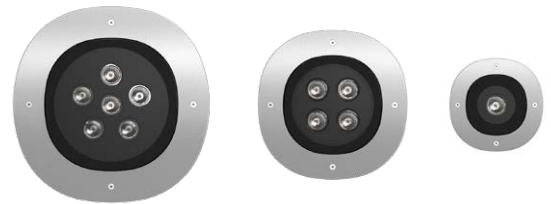

A-Rise



Gobi



C-Me

C-Me Round
C-Me Square



Ingraze

542

Ingraze Frame Fixed / Adjustable
Ingraze Frameless Fixed / Adjustable



Outgraze

604



Tau

654



Eclipse

666

Eclipse
Eclipse Mini

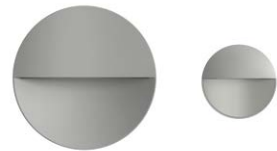

Hyperion

676

Hyperion
Hyperion Mini



Platter

686

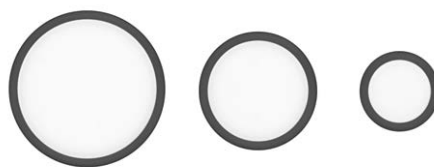

Leila

698



Kirk

710



Spock

718



Aimer

730

Aimer
Aimer Aqua



Franco

764

Franco
Franco Pole

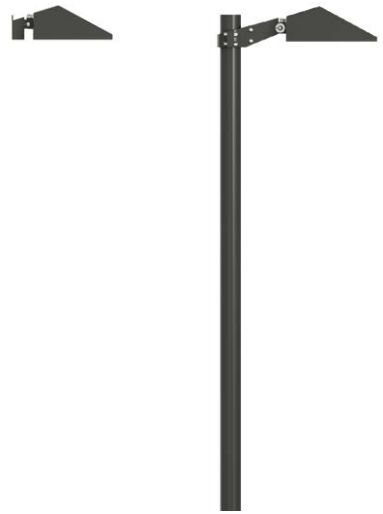

Perseo

786

Perseo
Perseo Pole



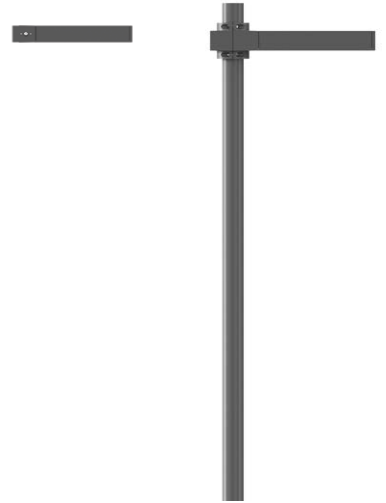

Contact Italy

Flos Spa
Via Angelo Faini, 2
25073 Bovezzo (Brescia)
Tel +39 0302438.1
Fax +39 0302438.250
info@flos.com

ARES s.r.l. - Socio Unico
Viale dell'Artigianato, 24
20881 Bernareggio
Monza Brianza, Italy
Tel +39 039 6900892
Fax +39 039 6901855
flos.outdoor@flos.com

Contact Spain

Antares Iluminación S.A.U.
Calle Mallorca, 1
Poligono Industrial Reva 46394
Ribarroja (Valencia)
Tel +34 96 166 95 20
Fax +34 96 166 82 86
flos.architectural@flos.com

Distribution Spain

Antares Iluminación s.A.U.
Calle Mallorca, 1
Poligono Industrial Reva
46394 Ribarroja (Valencia)
Tel +34 96 166 95 20
Fax +34 96 166 82 86
flos.architectural@flos.com

Distribution Belgium And Luxembourg

Flos Belux
M +32 474 739 080
flosbelux@flos.com

Distribution Norway

Drammensveien 120
0277 Oslo - Norway
Tel +47 (0) 2212 86 00
Fax +47 (0) 2212 86 08
info.norge@flos.com

Distribution Sweden

FLOS Sweden
Lützengatan 1
11520 Stockholm - Sweden
Tel +4686604405
info.se@flos.com

Distribution Denmark

FLOS Scandinavia A/S
Kuglegaardsvej 13-17
1434 Copenhagen K - Denmark
Tel +4533886000
info.dk@flos.com

Distribution Amsterdam

Cruquiusweg 109S
1019 AG Amsterdam
The Netherlands
Tel +31 (0) 20 560 50 60
flosnetherlands@flos.com

Distribution France

Flos France
20-22, Passage Dauphine
75006 Paris
Tel +33 (0) 1 40 64 17 44
flos.france@flos.com

Distribution Germany

Flos GmbH
Obermünsterstraße 18
93047 Regensburg,
Germany
Tel +49 941 630837 00
Fax +49 941 630837 60
info@flos-gmbh.de

Distribution United Kingdom

Atrium Ltd.
28 Leonard Street
EC2A 4BY London
Tel +44 (0) 20 7681 9933
Fax +44 (0) 20 7681 9943
flos@atrium.ltd.uk

International Projects
Boccia Giandonato
tel +44(0)20 7681 9933
giandonato.boccia@flos.com

Distribution Japan

Flos Co., Ltd.
PMC Building 9F
1-23-5 Higashiazabu
Minato-Ku Tokyo 104-0044
Tel +81 (0) 3 3582 1468
Fax +81 (0) 3 3582 097
flosjapan@flosjapan.com

Distribution Asia Pacific

50 Raffles Place, #30-00
Singapore Land Tower
Singapore 048623
Tel +65 90056328
Tel +65 91267780
flosasia@flos.com

Distribution China

Flos Illumination
(Shanghai) Co. Ltd.
Unit 101, Floor 1, Building B9
No. 800 of Chang De road
Jing An District, Shanghai,
200040, China
Tel +86 021 62176187

(South China)
Tel +86 1392 9975 703
alan.wong@flos.com

Distribution Latin America

Flos LatAm
M +52 55 6960 1772
flos.latinamerica@flos.com

Distribution India

Flos Representative Office
1, Commonwealth Lane
#08-12, 149544 Singapore
Tel +91 9999306667
Fax +65 (0) 6372 7607
flosindia@flos.com

Distribution U.S.A.

Flos USA Inc.
40-20 22nd Street - 3rd Floor
Long Island City, NY 11101
Tel +1 (800) 8414011
info@flosusa.com

Distribution Middle East

Flos Middle East
Dubai Design District
Building 1B, Office 303
P.O.Box number 333025
Dubai, United Arab Emirates
Tel: +971 4 566 0123
Mob: +971 543567356

Distribution Hong Kong

M +852 9307 3713
flosasia@flos.com

Ihr Ansprechpartner in der **Schweiz**
Votre contact en **Suisse**



liora design gmbh
Neuheimstrasse 40d
CH-8853 Lachen

info@liora-design.ch
liora-design.ch

P +41 55 511 21 80

Ihr Ansprechpartner in der **Schweiz**
Votre contact en **Suisse**

liora
design
FLOS Agency Suisse

liora design gmbh
Neuheimstrasse 40d
CH-8853 Lachen

info@liora-design.ch
liora-design.ch

P +41 55 511 21 80

Showroom Stockholm

FLOS Sweden
Lützensgatan 1
11520 Stockholm
Sweden
Tel +4686604405
info.se@flos.com

Showroom Copenhagen

FLOS Scandinavia A/S
Kuglegaardsvej 13-17
1434 Copenhagen K
Denmark
Tel +4533886000
info.dk@flos.com

Showroom Amsterdam

Cruquiusweg 109Q
1019 AG Amsterdam
The Netherlands
Tel +31 (0) 20 560 50 60
showroom.amsterdam@flos.com

Showroom Oslo

Drammensveien 120
0277 Oslo - Norway
Tel +47 (0) 2212 86 00
Fax +47 (0) 2212 86 08
info.norge@flos.com

Showroom Milano

Corso Monforte, 15
20122 Milano
Tel +39 02 79 84 57
Fax +39 02 89 78 56 41
showroom.milan@flos.com

Showroom Paris

20-22, Passage Dauphine
75006 Paris
Tel +33 (0) 1 40 64 17 44
flos.france@flos.com

Showroom Tokyo

PMC Building 9F
1-23-5 Higashiazabu
Minato-Ku
Tokyo 104-0044
Tel +81 (0) 3 35 82 14 68
Fax +81 (0) 3 3582 0974
showroom.tokyo@flos.com

Flagship Store Milano

Corso Monforte, 9
20122- Milano
Tel +39 02 37011080
Fax +39 02 780833
shop.milan@flos.com

Flagship Store Roma

Via del Babuino, 85
00187 - Roma
Tel +39 06 3207631
Fax +39 06 3207690
flosroma@flos.com

Flagship Store New York

135 Madison Ave
New York, NY 10016
Tel +1 212 941 4760
Fax +1 212 941 4763
info@flosusa.com

Flagship Store Paris

15, Rue de Bourgogne
75007- Paris
Tel +33 (0) 1 53 85 49 93
Fax +33 (0) 1 53 85 49 99
flosparis@flos.com

Flagship Store LYON

17 Rue Jarente
69002 - Lyon
Tel +33 478621301
Fax +33 478622119
floslyon@flos.com

Flagship Store Stockholm

FLOS Sverige
Lützensgatan 1
11520 Stockholm
Sweden
Tel +46086604405
info.se@flos.com

Art Direction and Graphic Design

Apartamento Studios

Art Photography

Nicholas Alan Cope

In-Place Photography

Tommaso Sartori

Iris Humn

Still Life Photography

Piero Fasanotto

Layout

Flos Architectural Team

Edition

February 2025

Copyright © Flos 2025

All Rights Reserved

Acknowledgements

Arch. Ricardo Bofill

Mrs. Natalia Chiner

Mrs. Celia Lescouet

Apulia Exclusive Houses

Comme notre monde est en constante évolution, des changements techniques apparaissent chaque jour dans notre activité.

L'objectif de Flos est de toujours offrir la meilleure technologie disponible, en révisant constamment nos produits et en les mettant à jour dès que des évolutions technologiques présentent des avantages pour nos partenaires et nos clients.

Cette philosophie signifie que notre catalogue et nos fiches techniques sont aussi en constante évolution et nécessitent des mises à jour et des révisions permanentes.

Ainsi, lorsque vous avez besoin de détails techniques et des dernières informations produits, veuillez consulter la section produit de notre site officiel flos.com : il est mis à jour quotidiennement et vous y trouverez les dernières informations produit, les codes des produits disponibles, et tous les catalogues à télécharger.

www.flos.com

As our world is in constant evolution, technical upgrades happens every day in our business.

Flos aim is to offer always the best reliable technology available, constantly reviewing our products and upgrading them as soon as technologic evolutions offers benefits for our partners and clients.

This philosophy means that our technical catalogue and product data sheets also are in constant evolution, requiring upgrades and constants reviewing.

Thus, when you need technical details and the most recent product information, please browse the product section of our Flos.com official website: it is updated daily, and there you'll find the latest product details, all available part numbers, all product documents available for immediate download.

www.flos.com



